



THE SOUTH AUSTRALIAN GOVERNMENT GAZETTE

www.governmentgazette.sa.gov.au

PUBLISHED BY AUTHORITY

ALL PUBLIC ACTS appearing in this GAZETTE are to be considered official, and obeyed as such

ADELAIDE, THURSDAY, 4 FEBRUARY 2010

CONTENTS

	Page		Page
Appointments, Resignations, Etc.....	406	Nurses Board of South Australia—Notice.....	447
Aquaculture Act 2001—Notice	407	Offshore Petroleum and Greenhouse Gas Storage Act 2006—Notice.....	456
Corporations and District Councils—Notices.....	679	Partnership Act 1891-1975—Notice	680
Crown Lands Act 1929—Notices.....	407	Petroleum and Geothermal Energy Act 2000—Notices	459
Development Act 1993—Notices.....	408	Proclamations	461
Electoral Act 1985—Notice	412	Public Sector Act 2009—Notice	459
Environment Protection Act 1993—Notice.....	415	Public Trustee Office—Administration of Estates	680
Firearms Act 1977—Notice.....	421	REGULATIONS	
Fisheries Management Act 2007—Notices	421	Electricity Act 1996 (No. 12 of 2010)	466
Geographical Names Act 1991—Notice	421	Anangu Pitjantjatjara Yankunytjatjara Land Rights Act 1981 (No. 13 of 2010).....	676
Health Act Act 2008—Notice	422	Road Traffic Act 1961—Notice	459
Highways Act 1926—Notices	422	Training and Skills Development Act 2008— Notice	457
Liquor Licensing Act 1997—Notices.....	422	Unclaimed Moneys Act 1891—Notices.....	681
Local Government Act 1999—Notice.....	425	Water Mains and Sewers—Main Laid, Replaced, Etc.....	459
Medical Board of South Australia—Notice.....	442		
Mining Act 1971—Notices.....	442		
National Parks and Wildlife Act 1972—Notices	443		

GOVERNMENT GAZETTE NOTICES

ALL poundkeepers' and private advertisements forwarded for publication in the *South Australian Government Gazette* must be PAID FOR PRIOR TO INSERTION; and all notices, from whatever source, should be legibly written on one side of the paper only and sent to **Government Publishing SA** so as to be **received no later than 4 p.m. on the Tuesday preceding the day of publication. Phone 8207 1045 or Fax 8207 1040. E-mail: governmentgazette@dpc.sa.gov.au**. Send as attachments in Word format and please confirm your transmission with a faxed copy of your document, including the date the notice is to be published and to whom the notice will be charged. The *Government Gazette* is available online at: www.governmentgazette.sa.gov.au

Department of the Premier and Cabinet
Adelaide, 4 February 2010

HIS Excellency the Governor in Executive Council has been pleased to appoint the undermentioned to the South Australian Film Corporation, pursuant to the provisions of the South Australian Film Corporation Act 1972:

Member: (from 26 February 2010 until 25 February 2011)
John Drinkwater Chataway

Member: (from 26 February 2010 until 25 February 2013)
Cheryl Sarah Bart
Bridget Alice Ikin

Chair: (from 26 February 2010 until 25 February 2013)
Cheryl Sarah Bart

By command,

TOM KOUTSANTONIS, for Premier

ASACAB001/08

Department of the Premier and Cabinet
Adelaide, 4 February 2010

HIS Excellency the Governor in Executive Council has been pleased to appoint the undermentioned to the Medical Board of South Australia, pursuant to the provisions of the Medical Practice Act 2004:

Member: (from 26 February 2010 until 25 February 2013)

Roger Neil Sexton
Helen Margaret Ingham
Anne Burgess

Deputy Member: (from 26 February 2010 until 25 February 2013)

Mary Gerardine White (Deputy to Sexton)

By command,

TOM KOUTSANTONIS, for Premier

HEAC-2009-00086

Department of the Premier and Cabinet
Adelaide, 4 February 2010

HIS Excellency the Governor in Executive Council has been pleased to appoint the undermentioned to the Art Gallery Board, pursuant to the provisions of the Art Gallery Act 1939:

Member: (from 8 February 2010 until 7 February 2013)

Frances Gerard
Tracey Anne Whiting

Member: (from 8 February 2010 until 7 February 2014)
Andrew William Gwinnett

Deputy Presiding Member: (from 8 February 2010 until 7 February 2014)
Andrew William Gwinnett

By command,

TOM KOUTSANTONIS, for Premier

ASACAB007/02

Department of the Premier and Cabinet
Adelaide, 4 February 2010

HIS Excellency the Governor in Executive Council has been pleased to appoint the undermentioned to the Nursing And Midwifery Board of South Australia, pursuant to the provisions of the Nursing and Midwifery Practice Act 2008:

Special Member: (from 4 February 2010 until 3 February 2013)

Aurianne Rhonda Webber

By command,

TOM KOUTSANTONIS, for Premier

HEAC-2009-00089

Department of the Premier and Cabinet
Adelaide, 4 February 2010

HIS Excellency the Governor in Executive Council has been pleased to appoint the undermentioned to the Board of the Environment Protection Authority, pursuant to the provisions of the Environment Protection Act 1993:

Member: (from 21 April 2010 until 20 April 2011)

Megan Frances Napier Dyson
Allan Norman Holmes
Andrew Vernon Fletcher

By command,

TOM KOUTSANTONIS, for Premier

EPCS10/0002

Department of the Premier and Cabinet
Adelaide, 4 February 2010

HIS Excellency the Governor in Executive Council has been pleased to appoint the undermentioned to the Medical Professional Conduct Tribunal, pursuant to the provisions of the Medical Practice Act 2004:

Member: (from 26 February 2010 until 25 February 2013)

Katrina Ruth Allen
Frederick Rhys Henning
Daniela Costa
Peter John Dobson
David Caryl Blaikie
Margaret Wallace

By command,

TOM KOUTSANTONIS, for Premier

HEAC-2009-00087

Department of the Premier and Cabinet
Adelaide, 4 February 2010

HIS Excellency the Governor in Executive Council has been pleased to appoint the undermentioned to the Lotteries Commission of South Australia, pursuant to the provisions of the State Lotteries Act 1966:

Member: (from 8 February 2010 until 7 February 2013)

Amanda Elizabeth Heyworth

Member: (from 22 March 2010 until 21 March 2013)

Anne Elizabeth Lindsay

Member: (from 1 April 2010 until 31 March 2013)

Hans Jurgen Ohff

Presiding Member: (from 1 April 2010 until 31 March 2013)

Hans Jurgen Ohff

By command,

TOM KOUTSANTONIS, for Premier

10MGE0001CS

Department of the Premier and Cabinet
Adelaide, 4 February 2010

HIS Excellency the Governor in Executive Council has been pleased to appoint the undermentioned to the State Opera of South Australia Board of Management, pursuant to the provisions of the State Opera of South Australia Act 1976:

Member: (from 4 February 2010 until 30 September 2011)

Pauline Anderson Ellison Brooks
Simon John Hatcher

Chair: (from 4 March 2010 until 30 September 2010)
Elizabeth Anne Raupach

By command,

TOM KOUTSANTONIS, for Premier

ASACAB016/02

Department of the Premier and Cabinet
Adelaide, 4 February 2010

HIS Excellency the Governor in Executive Council has been pleased to appoint Hieu Van Le as Governor's Deputy of South Australia for the period from 2 p.m. on Wednesday, 10 February 2010 until 4 p.m. on Thursday, 11 February 2010.

By command,

TOM KOUTSANTONIS, for Premier

Department of the Premier and Cabinet
Adelaide, 4 February 2010

HIS Excellency the Governor in Executive Council has been pleased to appoint Alan Peter Moss to the office of Judge of the Environment, Resources and Development Court of South Australia on an auxiliary basis from 4 February 2010 to 30 June 2010, pursuant to the provisions of the Judicial Administration (Auxiliary Appointments and Powers) Act 1988.

By command,

TOM KOUTSANTONIS, for Premier

AGO0302/02CS

Department of the Premier and Cabinet
Adelaide, 4 February 2010

HIS Excellency the Governor in Executive Council has been pleased to appoint Richard Evan Hardy to the office of Industrial Magistrate of the Industrial Relations Court of South Australia on an auxiliary basis from 4 February 2010 to 3 February 2011, pursuant to Section 3 of the Judicial Administration (Auxiliary Appointments and Powers) Act 1988.

By command,

TOM KOUTSANTONIS, for Premier

AGO0122/03CS

Department of the Premier and Cabinet
Adelaide, 4 February 2010

HIS Excellency the Governor in Executive Council has been pleased to appoint Simon Frederick Stretton and Anne Bampton as Judges of the District Court of South Australia from 4 February 2010, pursuant to Section 12 of the District Court Act 1991.

By command,

TOM KOUTSANTONIS, for Premier

AGO0071/03CS

Department of the Premier and Cabinet
Adelaide, 4 February 2010

HIS Excellency the Governor in Executive Council has been pleased to designate Simon Frederick Stretton and Anne Bampton as Judges of the Environment, Resources and Development Court of South Australia from 4 February 2010, pursuant to Section 8 (6) of the Environment, Resources and Development Court Act 1993.

By command,

TOM KOUTSANTONIS, for Premier

AGO0071/03CS

Department of the Premier and Cabinet
Adelaide, 4 February 2010

HIS Excellency the Governor in Executive Council has been pleased to appoint Simon Frederick Stretton and Anne Bampton as Deputy Presiding Officers of the Equal Opportunity Tribunal for a term of three years commencing on 4 February 2010 and expiring on 3 February 2013, pursuant to Section 18 of the Equal Opportunity Act 1984.

By command,

TOM KOUTSANTONIS, for Premier

AGO0071/03CS

Department of the Premier and Cabinet
Adelaide, 4 February 2010

HIS Excellency the Governor in Executive Council has been pleased to appoint Vaughan John Levitzke to the position of Chief Executive, Zero Waste SA, for a term of three years commencing on 17 February 2010 and expiring on 16 February 2013, pursuant to Section 8 of the Zero Waste SA Act 2004.

By command,

TOM KOUTSANTONIS, for Premier

ZWCS10/0001

Department of the Premier and Cabinet
Adelaide, 4 February 2010

HIS Excellency the Governor in Executive Council has accepted the resignation of Her Honour Judge Marie Elizabeth Shaw from the Office of Judge of the District Court of South Australia, the Office of Judge of the Environment, Resources and Development Court of South Australia and as Deputy Presiding Officer of the Equal Opportunity Tribunal, with effect from 29 January 2010.

By command,

TOM KOUTSANTONIS, for Premier

AGO0098/05CS

AQUACULTURE ACT 2001

Grant of Aquaculture Lease

PURSUANT to the provisions of section 22 of the Aquaculture Act 2001, Paul Caica, Minister for Agriculture, Food and Fisheries, hereby gives notice of the grant of the following leases for the purposes of Aquaculture in the waters of the state:

LA00170

Further details are available for the above lease granted on the PIRSA Aquaculture Public Register, which can be found at:

<https://info.pir.sa.gov.au/aquapr/page/gui3/map.html>.

PAUL CAICA, Minister for Agriculture,
Food and Fisheries

CROWN LANDS ACT 1929: SECTION 5

TAKE NOTICE that pursuant to the Crown Lands Act 1929, I, JAY WEATHERILL, Minister for Environment and Conservation, Minister of the Crown to whom the administration of the Crown Lands Act 1929 is committed DO HEREBY:

1. Resume the land defined in The First Schedule.
2. Dedicate the Crown Land defined in The Second Schedule as a Reserve for Water Management Purposes and declare that such land shall be under the care, control and management of the Minister for Environment and Conservation.

The First Schedule

Department of Mines and Energy Reserve, Section 1132, Hundred of Naracoorte, County of Robe, the notice of which was published in the *Government Gazette* of 12 March 1987 at page 608, The Third Schedule, being the whole of the land comprised in Crown Record Volume 5666, Folio 393.

The Second Schedule

Section 1132, Hundred of Naracoorte, County of Robe, exclusive of all necessary roads, being the whole of the land comprised in Crown Record Volume 5666, Folio 393.

Dated 4 February 2010.

JAY WEATHERILL, Minister for Environment
and Conservation

DL 2537/1986

CROWN LANDS ACT 1929: SECTION 5

TAKE NOTICE that pursuant to the Crown Lands Act 1929, I, JAY WEATHERILL, Minister for Environment and Conservation, Minister of the Crown to whom the administration of the Crown Lands Act 1929 is committed DO HEREBY:

1. Resume the land defined in The First Schedule.
2. Dedicate the Crown Land defined in The Second Schedule as a Reserve for Recreation and Community Purposes and declare that such land shall be under the care, control and management of the Tatiara District Council.

The First Schedule

Plantation and Recreation Reserve, Section 94, Hundred of Parsons, County of MacDonnell, the proclamation of which was published in the *Government Gazette* of 3 February 1972 at page 430, The Fourth Schedule, being the whole of the land comprised in Crown Record Volume 5666, Folio 430.

The Second Schedule

Section 94, Hundred of Parsons, County of MacDonnell, exclusive of all necessary roads, being the whole of the land comprised in Crown Record Volume 5666, Folio 430.

Dated 4 February 2010.

JAY WEATHERILL, Minister for Environment and Conservation

DEH 09/2253

CROWN LANDS ACT 1929: SECTION 5

TAKE NOTICE that pursuant to the Crown Lands Act 1929, I, JAY WEATHERILL, Minister for Environment and Conservation, Minister of the Crown to whom the administration of the Crown Lands Act 1929 is committed DO HEREBY resume the land defined in The Schedule.

The Schedule

Stone Reserve No. 5, now identified as Section 369, Hundred of Monbulla, the proclamation of which was published in the *Government Gazette* of 21 August 1890 at pages 430 and 431, being the whole of the land comprised in Crown Record Volume 5658, Folio 847.

Dated 4 February 2010.

JAY WEATHERILL, Minister for Environment and Conservation

DEH 09/3201

CROWN LANDS ACT 1929: SECTION 5

TAKE NOTICE that pursuant to the Crown Lands Act 1929, I, JAY WEATHERILL, Minister for Environment and Conservation, Minister of the Crown to whom the administration of the Crown Lands Act 1929 is committed DO HEREBY dedicate the Crown Land defined in The Schedule as Public Road.

The Schedule

Allotment 33 in Deposited Plan 66952, Hundred of Nangwarry, County of Grey, being within the Wattle Range district.

Dated 4 February 2010.

JAY WEATHERILL, Minister for Environment and Conservation

DEH 09/3437

CROWN LANDS ACT 1929: SECTION 5

TAKE NOTICE that pursuant to the Crown Lands Act 1929, I, JAY WEATHERILL, Minister for Environment and Conservation, Minister of the Crown to whom the administration of the Crown Lands Act 1929 is committed DO HEREBY resume the land defined in The Schedule.

The Schedule

Reserve for National Park Purposes, Allotment 1 in Deposited Plan 26077, Hundred of Santo, County of Cardwell, the notice of which was published in the *Government Gazette* of 7 September 1989 at page 835, The Second Schedule, being the whole of the land comprised in Crown Record Volume 5772, Folio 922.

Dated 4 February 2010.

JAY WEATHERILL, Minister for Environment and Conservation

DEH 09/3655

DEVELOPMENT ACT 1993, SECTION 25 (17): PORT AUGUSTA CITY COUNCIL—PORT AUGUSTA (CITY) URBAN GROWTH (PART 1)

Preamble

1. The Development Plan amendment entitled 'Port Augusta City Council—Port Augusta (City) Urban Growth (Part 1)' (the Plan Amendment) has been finalised in accordance with the provisions of the Development Act 1993.

2. The Minister for Urban Development and Planning has decided to approve the Plan Amendment.

NOTICE

PURSUANT to section 25 of the Development Act 1993, I—

- (a) approve the Plan Amendment; and
- (b) fix the day on which this notice is published in the *Gazette* as the day on which the Plan Amendment will come into operation.

Dated 4 February 2010.

PAUL HOLLOWAY Minister for Urban Development and Planning

DEVELOPMENT ACT 1993: SECTION 48

*Decision by the Governor**Preamble*

1. On 5 June 2003 a major development declaration was made for the subdivision and development of land at Buckland Park near Virginia north of Adelaide. The Minister for Urban Development and Planning gave notice in the *Government Gazette* that he was of the opinion that it was appropriate for the proper assessment of the development of major environmental, social or economic importance that Section 46 of the Development Act 1993 applied to any development of a kind listed in Schedule 1 of that notice in parts of the State listed in Schedule 2 of that notice.

2. On 4 January 2007, the earlier declaration from 5 June 2003 was varied to amongst other things, expand the major development declaration.

3. The declaration was subsequently varied again by notice in the *Government Gazette* on 12 June 2008 to include some extra land parcels within the major development declaration.

4. A proposal from Walker Corporation Pty Ltd (hereafter 'the proponent') to develop a substantial staged residential and commercial development at Buckland Park, was the subject of a development application lodged in May 2007 ('the major development').

5. The major development has been the subject of an Environmental Impact Statement (EIS) and has been assessed in accordance with Section 46 and Section 46B of the Development Act 1993, and it is now proposed to grant approval for the following components:

- Land Division, creating 8 super lots which include the 5 residential land division stages, employment lands, recreation/water management and transport infrastructure areas shown in plans 19000p01-r3, r5 and r6, 5 November 2009 (Fyfe Engineers Surveyors).
- Stage 1 land division (Super Lot 1 under the land division application) which will comprise 614 residential allotments, a school site, display centre and shopping /community centre over 62.23 hectares.
- Proposed partial closure of Legoe Road under Part 7A (Section 34C (2) (a) (ii)) of the Roads (Opening and Closing) Act 1991 (to take effect on a day to be fixed by subsequent order of the Governor or Planning Minister published in the *Gazette*).
- Construction of a Neighbourhood Centre as set out in the detailed drawings.

- Construction of a display village as detailed by the proponent.

Future stages of the development (2-5) which will be determined when detailed land division applications are lodged.

6. I am satisfied that an appropriate EIS and Assessment Report have been prepared in relation to the major development, in accordance with sections 46 and 46B, Division 2 of Part 4 of the Development Act 1993, and have had regard when considering the major development, to all relevant matters under Section 48 (5) of the Development Act 1993.

7. I have decided to grant provisional development authorisation to specified components of the major development under Section 48 (6) of the Development Act 1993, whilst reserving the decision on specific matters until further assessment of the major development.

8. Contemporaneously with the issuing of the Notice, I intend, pursuant to Section 48 (8) of the Development Act 1993 to delegate to the Minister:

- the power to assess the reserve matters and to issue a final development authorisation for the purposes of Section 48 (2) (b) (i) of the Act; and
- in relation to that provisional development authorisation, or any variation—the power to vary or revoke conditions, or attach new conditions, under Section 48 (7) of the Development Act 1993 (provided that the essential nature of the development is not changed).

Decision

PURSUANT to Section 48 of the Development Act 1993 and with the advice and consent of the Executive Council, and having due regard to the matters set out in Section 48 (5) and all other relevant matters, I:

- grant a provisional development authorisation in relation to Stage 1 (Land Division for 614 residential allotments, construction of a neighbourhood centre and display village and construction of necessary roads and reserves and the land division 'Super Lot Plan') under Section 48 (6) subject to the conditions set out in Part B below;
- pursuant to Section 48 (6) reserve my decision on the matters specified in Part A below;
- specify all matters relating to this provisional development authorisation as matters in respect of which conditions of this authorisation may be varied revoked, or new conditions attached; and
- specify for the purposes of Section 48 (11) (b) the period up until 1 February 2012 as the time within which substantial work must be commenced on site, failing which I may cancel this authorisation.

PART A: RESERVED MATTERS

The following are the matters reserved for further assessment:

- Compliance with the Building Rules in relation to the Neighbourhood centre and Display village of the major development for Stage 1.
- Residential Design Details and a Scheme Description and By Laws requirement incorporating all details as per the Response Document shall be provided for any Community Titled and Torrens Titled allotments.
- Provision of an Affordable Housing Land Management Agreement (LMA) pursuant to Section 57 of the Development Act 1993, in relation to the provision of affordable housing in the land division for Stage 1. The LMA will be registered on each new house allotment title for affordable blocks.
- A reconfigured land division plan be submitted to effect the need for a 40 metre buffer between the SA Potato growers horticultural activity (on the southern side of the land division) and the outer boundary of the subdivision area.
- A Construction Environment Monitoring and Management Plan for Stage 1 is completed to the satisfaction of the Environment Protection Agency (EPA) and approval of Minister for Urban Development and Planning.

- An Ongoing Environment Monitoring and Management Plan completed to the satisfaction of the EPA and approval of the Minister for Urban Development and Planning.
- Signage associated with the proposed Neighbourhood Centre.
- Final design of the 32 dwellings proposed in the display village.
- A Schedule of Commitments as specified in Schedule 1 will be required for Stage 1 to be signed by the State Government, City of Playford and the Walker Corporation. The commitments identified will need to be satisfied before residents move into Stage 1.

SCHEDULE 1—SCHEDULE OF COMMITMENTS

- Final Design drawings for the signalised intersection of Legoe Road with Port Wakefield Road to the satisfaction of the Department of Transport Energy and Infrastructure (DTEI).
- Proponent to prepare a strategy for the provision of a second access if main entry is blocked or unserviceable by vehicles in accordance with DTEI and City of Playford specifications.
- Detailed design of local roads to be constructed and commissioned in accordance with City of Playford specifications and to City of Playford's approval.
- Agreement between the City of Playford and the proponent for the provision, timetabling and staffing of the community bus to be provided by the proponent as per the Infrastructure Schedule in the supporting information provided by the proponent in November 2009.
- Proponent to commit to employment of a Community worker after discussions with the City of Playford on the role and employment conditions of the worker.
- Proponent to prepare a Recreation Facilities Strategy in collaboration with the City of Playford's Buckland Park Project Control Group.
- Proponent to prepare detailed landscape and engineering designs for Playford City Council approval including details on:
 - hard and soft paving;
 - plant locations, numbers, size and species;
 - street furniture, including rubbish bins;
 - play equipment type and location;
 - lighting and signage;
 - irrigation systems and application of WSUD principles;
 - maintenance schedules; and
 - handover and defects liability periods.
- Proponent to provide accurate projections of resident populations to allow Department of Health to plan for local and regional health services.
- Proponent to enter into an SA Water Agreement for all water and wastewater requirements for Stage 1.
- Proponent to prepare water storage treatment and re-use system within Stage 1 for City of Playford approval.
- Proponent to enter into an agreement with ETSA for the provision of required upgrades.
- Proponent to commit to provide a new 200 mm steel main from Epic Gas Station to site.
- Proponent to enter agreement with APA Gas Services for provision of gas to the site.
- Proponent to negotiate with APA Gas Services on amplification of Epic Gas Gate Station.
- Engineering construction plans for roads, drainage and footpaths and intersections to the satisfaction of the City of Playford.
- Proponent to negotiate with Department of Education and Children's Services on suitable timing of additional demountable class rooms for Virginia Primary School.

- (17) Proponent to liaise with the City of Playford in relation to the provision of library services to Buckland Park.
- (18) Proponent to identify land within stage 1 for Telstra facilities and negotiate fibre connections from Port Wakefield Road to site.
- (19) Preparation of implementation of a Flood Access Plan for Port Wakefield Road by the Northern Adelaide Zone Emergency Management Committee and DTEI.

PART B: CONDITIONS OF PROVISIONAL DEVELOPMENT
AUTHORISATION

1. The development authorisation granted hereunder is provisional only, does not operate as a final development authorisation, and does not therefore authorise implementation of the major development. Authorisation will only be granted after the reserved matters have been assessed and approved.

- 1a. except where minor amendments may be required by other legislation, or conditions imposed herein, the major development shall be undertaken in strict accordance with the following documents:

- Development Application from Walker Corporation dated May 2007 (except to the extent that it may be varied by a subsequent document in this paragraph);
- Buckland Park Environmental Impact Statement and Appendices dated March 2009 Walker Corporation (except to the extent that it may be varied by a subsequent document in this paragraph);
- Buckland Park Response Document and Appendices dated October 2009 Walker Corporation (except to the extent that it may be varied by a subsequent document in this paragraph);
- Letter dated 10 November 2009 from Walker Corporation—Additional information on Sea Level Rise;
- Letter dated 10 November 2009 from Walker Corporation—Additional information on Access during a Flood Event;
- Letter dated 12 November 2009 from Walker Corporation—Redesigned illustrations of the Super Lot Proposal for the Master Plan;
- Letter dated 17 November 2009 from Walker Corporation—Additional Information on Mosquitoes;
- Letter dated 18 November 2009 from the Walker Corporation—Schedule of Infrastructure;
- Letter dated 24 November 2009 from Walker Corporation—Additional Information on Flood and Stormwater;
- And drawing Numbers specified below provided in consolidated maps dated 9 November 2009 Cover sheet Revision 3; and
- Letter dated 17 December 2009 setting out the details of the 'Display Homes' in the display village.

DRAWINGS

- 19000P01—r5 Issue 6 Fyfe Engineers Surveyors Super Lots—Sheet 1 dated 5 November 2009;
- 19000P01—r6 Issue 6 Fyfe Engineers Surveyors Super Lots—Sheet 2 dated 5 November 2009;
- 19000P01—r3 Issue 4 Fyfe Engineers Surveyors Super Lots Sheet 3 dated 5 November 2009;
- 19000P02—r5 Issue 5 Fyfe Engineers Surveyors Stage 1 Concept Land Division—Sheets 1-4;
- Version 1 Revision G Connor Holmes Buckland Park Special Fencing control dated 22 September 2009;
- CMS-01 Revision 1 Walker Corporation Concept Neighbourhood Centre dated February 2009;
- CMS-02 Revision 1 Walker Corporation Display Village Location dated February 2009; and
- 071315SK29 Revision 0 Swanbury Penglase Stage 1 Neighbourhood Centre Landscape Concept Dated 5 March 2009.
- Assessment Report prepared by the Minister for Urban Development and Planning dated January 2010.

2. The proponent shall provide 2 copies of certified surveyed plans for stage 1, which satisfy compliance with Section 51 and the subsequent issue of Certificates of Title.

3. The layout of parking areas for the Neighbourhood centre shall meet the Australian/New Zealand Standard 2890.1:2004, Parking Facilities—Off-street car parking and line markings and Australian Standard 2890.2-2002 Parking Facilities—off-street commercial vehicle facilities (including service areas).

4. Access and egress from the car parking areas of the Neighbourhood centre shall be designed in accordance with the Australian/New Zealand Standard 2890.1 2004, Parking Facilities, Part 1 off street car parking.

5. All car parking areas, driveways and vehicle manoeuvring areas for the neighbourhood centre and display village shall be properly maintained at all times.

6. Any traffic control devices shall be designed and constructed in accordance with the main standard of the Manual of Uniform Traffic Control Devices—AS 1742.

7. Lighting shall be provided within the car parking area of the Neighbourhood Centre including the open space/park/playground and land division in accordance with the following:

- street lighting and lighting for outdoor car parks AS/NZS; Lighting for roads and public spaces, in particular, lighting for outdoor car parks AS/NZS.

8. Waste disposal vehicles and general delivery vehicles shall only service the Neighbourhood centre development between the hours of 7 a.m. and 7 p.m. Monday to Saturday inclusive, and shall only load or unload within the confines of the subject land.

9. That all plant that is located on the roofed area of the Neighbourhood centre shall be housed within a contained area as part of the roof design and shall not be openly visible.

10. All design and construction shall be in accordance with Australian/New Zealand Standards for Off-street parking facilities (AS2890.1 for cars, AS 2890.2 for commercial vehicles).

11. Cut and fill batters required for road works shall be in accordance with the requirements of the Engineering Design Guidelines of the City of Playford.

12. Normal operating hours for construction activities and construction truck movements to and from the site shall be from 7 a.m. to 7 p.m. Monday to Saturday inclusive.

13. Water-sensitive urban design measures and practices shall be adopted for the management of run-off, including stormwater capture and reuse.

14. Stockpiled soils shall be suitably managed to control dust emissions, erosion and weed infestation.

15. Undeveloped allotments shall be left in a neat and tidy condition, with soil surfaces stabilised to minimise erosion.

16. Landscaping and streetscaping of the common areas of the site shall commence prior to the issuing of the Certificates of Title for stage 1 of the land division, and when established shall be maintained in good health and condition at all times. A plant shall be replaced if and when it dies or becomes seriously diseased. A weed control plan shall also be implemented.

17. That the acoustic barriers and fencing surrounding the open space and along the boulevards shall be treated with a suitable anti-graffiti coating to facilitate easy removal of graffiti.

18. The waste and any general storage areas of the Neighbourhood Centre buildings and car parking areas shall be kept in a neat, tidy safe, healthy condition, contained and hidden from view at all times.

19. A signalised intersection at the junction of Port Wakefield Road/Legoe Road must be provided by the proponent to the satisfaction of Department of Transport, Energy and Infrastructure (DTEI) and approved by the Minister for Urban Development and Planning.

20. Stormwater Management Plan for stage 1 be negotiated with City of Playford, the Environment Protection Agency and the Department of Water, Land and Biodiversity and to the satisfaction of the Minister for Urban Development and Planning.

21. The proponent will prepare a landscape strategy for Stage 1, which will:

- set desired character;
- set urban design objectives;

- set design themes and principles;
- nominate street tree themes;
- design pedestrian paths and cycle ways (including provision for bicycle parking);
- include Management plans for landscape items; and
- include Maintenance and defects periods hand over agreement with City of Playford.

PART C: NOTES TO PROPONENT

1. In respect of the reserved matters, the following is advised to the proponent:

(a) *Building Rules*

The proponent must obtain a Building Rules assessment and certification from either the City of Playford or a private certifier (at the proponent's option) and forward to the Minister all relevant certification documents as outlined in Regulation 64 of the Development Regulations 2008, in relation to the building works for the Neighbourhood Centre and Display village; and

Pursuant to Development Regulation 64, the proponent is especially advised that the City of Playford or private certifier conducting a Building Rules assessment must:

- provide to the Minister for Urban Development and Planning a certification in the form set out in Schedule 12A of the Development Regulations 2008 in relation to the building works in question; and
- to the extent that may be relevant and appropriate:
 - (i) issue a Schedule of Essential Safety Provisions under Division 4 of Part 12;
 - (ii) assign a classification of the buildings under these regulations; and
 - (iii) ensure that the appropriate levy has been paid under the Construction Industry Training Fund 1993.

Regulation 64 of the Development Regulations 2008 provides further information about the type and quantity of all Building Rules certification documentation for major developments required for referral to the Minister for Urban Development and Planning. The City of Playford or private certifier undertaking Building Rules assessments must ensure that the assessment and certification are consistent with the provisional development authorisation (including its Conditions and Notes).

(b) *A Construction, Environmental Management and Monitoring Plan covering preconstruction and construction phases*

A Construction Environmental Management and Monitoring Plan (CEMMP) covering both pre-construction and construction phases shall be prepared in consultation with the EPA, before its submission to the Minister for approval. The CEMMP shall include the following:

- reference to, and methods of adherence to, all relevant EPA policies and codes of practice for construction sites, including the inclusion of a copy of Schedule 1 of the Environment Protection Act 1993 as an Appendix to the Construction Environmental Management and Monitoring Plan to ensure contractors are aware of EPA requirements;
- address management issues during construction and including a site audit (or as required by EPA);
- timing, staging and methodology of the construction process and working hours (refer also to conditions outlining working hours);
- a risk assessment relating to the potential impacts of construction activities;
- traffic management strategies during construction, including transport beyond the development site;
- management of infrastructure services during construction;

- control and management of construction noise, vibration, dust and mud;
- stormwater and groundwater management during construction;
- identification and management of contaminated soils and groundwater, should these be encountered;
- site security, fencing and safety and management of impacts on local amenity for residents, traffic and pedestrians;
- disposal of construction waste, any hazardous waste and refuse in an appropriate manner according to the nature of the waste;
- protection and cleaning of roads and pathways as appropriate; and
- overall site cleanup.

The CEMMP should be prepared taking into consideration, and with explicit reference to, relevant Environment Protection Authority policies and guideline documents, including the Environment Protection (Noise) Policy 2007.

(c) *Operational Environment Management Plan*

The Operational Environment Management Plan would need to be prepared for both the commercial and residential components, to the reasonable satisfaction of the EPA, the Department of Water, Land and Biodiversity Conservation and the City of Playford, prior to construction commencing, for approval by the Minister for Urban Development and Planning

2. The proponent is advised that noise emissions from the Neighbourhood centre and residential (display village) development will be subject to the Environment Protection (Noise) Policy 2007 and the Environment Protection Act 1993.

3. If the development is not substantially commenced within two years of the date of the decision on the last of the reserved matters, the Governor may cancel this development authorisation.

4. The proponent is advised of the General Environmental Duty under Section 25 of the Environment Protection Act 1993, which provides that a person must not undertake any activity, which pollutes, or may pollute, without taking all reasonable and practical measures to prevent or minimise harm to the environment.

5. The proponent is advised of the requirement to comply with the EPA's 'Stormwater Pollution Prevention Code of Practice for the Building and Construction Industry' during demolition and construction of the development.

6. The proponent is advised that the Development Act 1993 outlines the roles and responsibilities of the applicant and the City of Playford for matters relating to building works during and after construction of the neighbourhood centre and display village and associated works.

7. Partial closure of Legoe Road under Part 7A (Section 34C (2) (a) (ii)) of the Roads (Opening and Closing) Act 1991 as described in drawing number 19000PO2—r5 Issue 5—Sheets 1-4 to take effect on a day to be fixed by subsequent order of the Governor or Planning Minister published in the *Gazette*, once surveyed Land Division plans have been submitted and alternate physical access is provided to all affected allotments.

8. Section 51 of the Development Act 1993 will apply to the land division in that the proponent will need to satisfy the requirements of this Section in order to implement this land division.

9. This approval does not include any approval for dwellings as it is not part of this application.

10. This approval does not include any approval for signs (as defined as Development under the Development Act 1993) as it is not part of this application.

11. The provisions of the Food Act 2001, and associated food regulations apply.

12. Any Sanitation units installed in the Neighbourhood Centre will be installed as per the requirements of the Public and Environmental Health Act (1987).

13. That provision shall be made for secure storage of shopping trolleys within the neighbourhood complex at night to the reasonable satisfaction of the City of Playford.

14. In addition to the Building Code of Australia, the proponent must comply with the Commonwealth Disability Discrimination Act, 1992 in planning access for the disabled.

15. The main standard for traffic control devices is the Manual of Uniform Traffic Control Devices—AS 1742. There are many standards under AS 1742 covering the various traffic control devices that may need to be referred to.

16. As per Schedule 8, Item 23, Development Regulations 2008, and the Affordable Housing Act 2007 for the proposal to include 15% affordable housing.

17. The proponent should note that they and their contractors must comply with the requirements of the Aboriginal Heritage Act, 1988.

18. The proponent should note that they and their contractors must comply with the Adelaide Dolphin Sanctuary Act 2005 and the general duty of care under that Act.

19. Proponent to undertake vegetation surveys and to complete a Significant Environmental Benefit (SEB) with attached Vegetation Management Plans to the satisfaction of the Department of Environment and Heritage for Stages 2-5 where native vegetation exists on the site (there is no native vegetation in Stage 1).

20. Approval for further Road closures under the Roads (Opening and Closing Act) 1991 will be required in future stages of the development and will proceed through the normal (Council) process in relation to this matter.

21. The Minister has a specific power to require testing, monitoring and auditing under Section 48C of the Development Act 1993.

Given under my hand at Adelaide, 4 February 2010.

KEVIN SCARCE, Governor

DEVELOPMENT ACT 1993: SECTION 48

Notice by the Governor

Preamble

1. I have given a provisional development authorisation, pursuant to section 48 of the Development Act 1993, for the development of a residential development (Stage 1 and Super Lot Land Division, Neighbourhood Centre and Display Village) at Buckland Park by the Walker Corporation, which authorisation is published in the *Government Gazette* of 4 February 2010.

2. I wish to delegate certain of my powers under section 48 to the Minister for Urban Development and Planning.

Delegation

PURSUANT to section 48 (8) of the Development Act 1993 and with the advice and consent of the Executive Council I make the following delegations:

1. I delegate to the Minister for Urban Development and Planning:

- (a) my power to assess and approve the reserved matters specified in the said provisional development authorisation (provided the essential nature of the development is not changed);
- (b) my power under section 48 (7) (a) to grant or permit any variation associated with the said provisional development authorisation (provided the essential nature of the development is not changed);
- (c) in relation to the said provisional development authorisation, or any variation of my power to vary or revoke conditions or to attach new conditions, under section 48 (7) (provided the essential nature of the development is not changed);
- (d) if all reserved matters specified in the said provisional development authorisation have been approved, my power to grant the development authorisation required under section 48 (2) (b) (i) (provided there has been no alteration to the Environmental Impact Statement to which section 47 (2) (b) has applied);

(e) my power under section 48 (2) (a) to indicate that a development authorisation will not be granted, should there be any amendment to the Environmental Impact Statement to which section 47 (2) (b) has applied; and

(f) my power to grant the development authorisation required under section 48 (2) (b) (i) if there has been any amendment to the Environmental Impact Statement to which section 47 (2) (b) has applied.

Given under my hand at Adelaide, 4 February 2010.

KEVIN SCARCE, Governor

ELECTORAL ACT 1985: PART 3, DIVISION 4

District Polling Places

PURSUANT to section 18 of the Electoral Act 1985, I, Kay Marie Mousley, Electoral Commissioner, hereby abolish the polling places described in the notice contained on page 5305 of the *South Australian Government Gazette*, dated 4 December 2008 and appoint the following places to be polling places for both the Legislative Council district of South Australia and for the House of Assembly districts as specified:

District of Adelaide

Adelaide, Adelaide Hospital, Adelaide South, Adelaide West, Collinswood (S1), Lower North Adelaide, Nailsworth (S2), North Adelaide East, Prospect, Prospect North (S1), Prospect South, Walkerville.

District of Ashford

Black Forest, Clarence Park, Clarence Park West, Cowandilla (S1), Edwardstown (S2), Glandore South, Goodwood (S1), Keswick, Kurralta Park, Plympton, Plympton West (S1), Richmond, South Plympton, Wayville.

District of Bragg

Beaumont, Burnside, Crafers (S1), Glen Osmond, Glenunga (S2), Kensington Gardens (S2), Linden Park, Marryatville (S2), Norwood (S2), Piccadilly, Rose Park, Stonyfell (S1), Summertown, Tusmore, Uraidla.

District of Bright

Brighton, Hallett Cove, Hallett Cove South, Marino, North Brighton, Seacliff, South Brighton, West Brighton.

District of Chaffey

Barmera, Berri, Cobdogla, Glossop, Loxton, Loxton North, Lyrup, Monash, Moorook, Nildottie, Paringa, Purnong, Ramco, Renmark, Renmark North, Renmark West, Swan Reach, Waikerie, Winkie.

District of Cheltenham

Albert Park, Cheltenham, Findon West, Pennington, Queens-town, Rosewater (S1), Royal Park (S1), Royal Park South (S1), Seaton (S2), Seaton Park (S2), Woodville (S1), Woodville Gardens (S2), Woodville South, Woodville West.

District of Colton

Fulham, Fulham Gardens, Grange (S1), Henley Beach, Henley South, Kidman Park, Lockleys (S1), Seaton Park (S1), Seaton West (S1).

District of Croydon

Allenby Gardens, Beverley, Brompton, Croydon, Croydon Park, Croydon Park West, Findon, Flinders Park, Kilkenny, Renown Park, West Croydon, West Hindmarsh, Woodville (S2).

District of Davenport

Bedford Park, Belair (S2), Bellevue Heights, Blackwood, Blackwood Central, Coromandel Valley, Eden Hills, Flagstaff Hill (S1), Flagstaff Hill East, Glenalta, Hawthorndene, Pasadena (S2).

District of Elder

Ascot Park South, Clarence Gardens, Edwardstown (S1), Forbes, Marion (S1), Melrose Park, Mitchell Park, Mitchell Park South, Oaklands Park (S2), Parkholme (S1), Parkholme South, Pasadena (S1), St Marys, Warradale (S2).

District of Enfield

Blair Athol, Blair Athol North, Broadview, Clearview, Collinswood (S2), Enfield, Enfield North (S1), Ferryden Park, Kilburn, Mansfield Park (S1), Nailsworth (S1), Northfield South (S2), Prospect North (S2), Woodville Gardens (S1).

District of Finnis

American River, Delamere, Goolwa Central (S2), Gosse, Hindmarsh Valley, Hope Forest, Inman Valley, Kingscote, Middleton, Mount Compass, Myponga, Parawa, Parndana, Penneshaw, Port Elliot, Second Valley, Sellicks Beach, Victor Harbor, Victor Harbor East, Victor Harbor South, Yankalilla.

District of Fisher

Aberfoyle Park, Aberfoyle Park Central, Aberfoyle Park North, Aberfoyle Park South, Cherry Gardens, Clarendon, Flagstaff Hill (S2), Happy Valley, O'Halloran Hill, Reynella East (S1).

District of Flinders

Arno Bay, Ceduna, Cleve, Coffin Bay, Cowell, Cummins, Darke Peak, Elliston, Karkoo, Kirton Point, Lock, Minnipa, North Shields, Poochera, Port Kenny, Port Lincoln, Port Lincoln Central, Port Lincoln South, Port Neill, Smoky Bay, Streaky Bay, Tumby Bay, Ungarra, Wangary, Warrambo, Wirrulla, Wudinna.

District of Florey

Gilles Plains East (S1), Holden Hill North, Hope Valley, Modbury Central, Modbury Heights, Modbury North, Modbury West, Para Hills East (S2), Para Vista (S2), Redwood Park (S2), Ridgehaven (S2), St Agnes West (S2), Valley View (S2), Wynn Vale West (S2).

District of Frome

Alford, Auburn, Blyth, Brinkworth, Bute, Clare, Crystal Brook, Georgetown, Gladstone, Laura, Lochiel, Manoora, Marrabel, Napperby, Port Broughton, Port Pirie South, Port Pirie West, Redhill, Risdon Park East, Risdon Park South, Riverton, Saddleworth, Snowtown, Solomontown, Tarlee, Watervale, Yacka.

District of Giles

Andamooka, Coober Pedy, Hawker, Iron Knob, Kimba, Quorn, Roxby Downs, Whyalla Central East, Whyalla Central West, Whyalla Norrie East, Whyalla Norrie North, Whyalla Norrie North-West, Whyalla Norrie South, Whyalla Stuart South, Whyalla Stuart West, Woomera.

District of Goyder

Ardrossan, Arthurton, Balaklava, Coobowie, Corny Point, Curramulka, Dublin, Edithburgh, Hamley Bridge, Hardwicke Bay, Kadina, Maitland, Mallala, Marion Bay, Minlaton, Moonta, Owen, Paskeville, Pine Point, Port Clinton, Port Victoria, Port Vincent, Port Wakefield, Stansbury, Wallaroo, Wallaroo Mines, Warooka, Yorketown.

District of Hammond

Coomandook, Currency Creek, Goolwa, Goolwa Central (S1), Jervois, Karoonda, Lameroo, Langhorne Creek, Milang, Murray Bridge, Murray Bridge East, Murray Bridge South, Murray Bridge West, Mypolonga, Parilla, Pinnaroo, Ponde, Tailern Bend, Wellington West, Woods Point.

District of Hartley

Campbelltown, Felixstow, Glynde, Hectorville North, Kensington Gardens (S1), Kensington Park, Magill (S2), Magill North, Paradise West, Rostrevor South (S2), Tranmere.

District of Heysen

Aldgate, Ashbourne, Bridgewater, Crafers (S2), Echunga, Hahndorf, Kangarilla, Longwood, Macclesfield, Meadows, Mount Barker (S2), Mylor, Prospect Hill, Stirling East, Stirling West, Strathalbyn, Upper Sturt, Woodchester.

District of Kaurna

Aldinga Beach, Aldinga Beach West, Christies Beach, Christies Beach North, Maslin Beach, Moana, Old Noarlunga, Port Noarlunga, Seaford, Seaford Rise.

District of Kavel

Balhannah, Basket Range, Birdwood, Brukunga, Callington, Charleston, Gumeracha, Harrogate, Lenswood, Littlehampton, Lobethal, Mount Barker (S1), Mount Barker Central, Mount Torrens, Nairne, Woodside.

District of Lee

Birkenhead, Ethelton, Grange (S2), Largs Bay (S1), Largs Bay Central (S1), Royal Park (S2), Royal Park South (S2), Seaton (S1), Seaton West (S2), Semaphore, Semaphore Park, Semaphore Park South, Semaphore South, West Lakes Shore.

District of Light

Angle Vale (S2), Evanston, Evanston Gardens, Gawler, Gawler East, Gawler River, Gawler South, Gawler West, Hewett, Munno Para, Roseworthy, Sandy Creek (S2), Smithfield Plains, Wasleys.

District of Little Para

Elizabeth (S1), Elizabeth East, Elizabeth Grove, Elizabeth South (S2), Elizabeth Vale, Fairview Park, Golden Grove, Greenwith (S2), Greenwith West (S1), Hillbank, Salisbury Heights, Salisbury Park (S1), Surrey Downs.

District of MacKillop

Beachport, Bordertown, Coonalpyn, Coonawarra, Frances, Furner, Greenways, Hynam, Keith, Kingston, Kybybolite, Lucindale Central, Meningie, Millicent, Millicent South, Mount Burr, Mundulla, Naracoorte, Naracoorte South, Padthaway, Penola, Rendelsham, Robe, Southend, Tantanoola, Tintinara, Western Flat, Willalooka, Wolseley.

District of Mawson

Hackham, Hackham East (S1), Hackham South, McLaren Flat, McLaren Vale, Noarlunga Downs, Reynella East (S2), Willunga, Woodcroft.

District of Mitchell

Marion (S2), Oaklands Park (S1), Reynella (S1), Reynella South (S1), Seacombe Gardens, Seacombe Heights, Seaview Downs, Sheidow Park North, Sheidow Park South, Sturt, Warradale (S3).

District of Morialta

Athelstone, Athelstone West, Magill (S1), Montacute, Norton Summit, Paradise, Paradise East, Rostrevor, Rostrevor North, Rostrevor South (S1), Stonyfell (S2).

District of Morphett

Glenelg Central, Glenelg East, Glenelg North, Glenelg South, Glemgowrie, Grovane, Morphettville, Novar Gardens (S1), Parkholme (S2), Somerton Park East, Warradale (S1).

District of Mount Gambier

Carpenter Rocks, Compton, Glenburnie, Glencoe, Kalangadoo, Kongorong, Moorak, Mount Gambier, Mount Gambier East, Mount Gambier North, Mount Gambier Park, Mount Gambier West, Nangwarry, Port MacDonnell, Suttontown, Tarpeena, Yahl.

District of Napier

Craigmore, Craigmore North, Craigmore South, Davoren Park North, Davoren Park South, Elizabeth (S2), Elizabeth Downs, Elizabeth North, Elizabeth Park, One Tree Hill, Smithfield.

District of Newland

Banksia Park, Cudlee Creek, Highbury East, Highbury South (S1), Houghton, Paracombe, Redwood Park (S1), Ridgehaven (S1), St Agnes, St Agnes West (S1), Tea Tree Gully.

District of Norwood

Hackney, Joslin, Kent Town, Klemzig (S2), Marden West, Marryatville (S1), Maylands, Norwood (S1), Norwood West, St Morris, St Peters, Trinity Gardens, Vale Park.

District of Playford

Enfield North (S2), Ingle Farm, Ingle Farm North, Para Hills East (S1), Para Hills West, Para Vista (S1), Pooraka, Pooraka North, Valley View (S1), Walkley Heights.

District of Port Adelaide

Largs Bay (S2), Largs Bay Central (S2), Mansfield Park (S2), Mawson Lakes, North Haven, Ottoway, Parafield Gardens (S1), Parafield Gardens Central (S2), Parafield Gardens North-West (S3), Paralowie West (S2), Port Adelaide, Rosewater (S2), Taperoo, Taperoo East.

District of Ramsay

Brahma Lodge, Parafield Gardens (S2), Parafield Gardens Central (S1), Parafield Gardens North-West (S1), Paralowie (S1), Salisbury, Salisbury Central, Salisbury Downs, Salisbury North (S1), Salisbury North-West (S2), Salisbury Park (S2).

District of Reynell

Christie Downs, Hackham East (S2), Lonsdale, Morphett Vale, Morphett Vale East, Morphett Vale North, Morphett Vale South, Onkaparinga Hills, O'Sullivan Beach, Pimpala, Reynella (S2), Reynella South (S2).

District of Schubert

Angaston, Cambrai, Eden Valley, Forreston, Freeling, Greenock, Kersbrook, Keyneton, Lyndoch, Mannum, Moculta, Mount Pleasant, Nuriootpa, Palmer, Sandy Creek (S1), Sedan, Springton, Stockwell, Tanunda, Walker Flat, Williamstown.

District of Stuart

Blanchetown, Booborowie, Booleroo Centre, Burra, Cadell, Davenport, Eudunda, Farrell Flat, Hallett, Jamestown, Kapunda, Leigh Creek, Melrose, Morgan, Orroroo, Peterborough, Point Pass, Port Augusta, Port Augusta West, Port Germein, Robertstown, Spalding, Stirling North, Terowie, Truro, Willsden, Wilmington, Wirrabara.

District of Taylor

Andrews Farm, Angle Vale (S1), Burton, Direk, Elizabeth South (S1), Parafield Gardens North-West (S2), Paralowie (S2), Paralowie West (S1), Salisbury North (S2), Salisbury North-West (S1), Two Wells, Virginia.

District of Torrens

Dernancourt, Gilles Plains East (S2), Greenacres, Hampstead Gardens, Highbury South (S2), Hillcrest, Holden Hill, Klemzig (S1), Northfield, Northfield South (S1), Northgate, Windsor Gardens East, Windsor Gardens West.

District of Unley

Fullarton, Glenunga (S1), Goodwood (S2), Goodwood Park, Hyde Park, Malvern, Myrtle Bank, Parkside East, Unley.

District of Waite

Belair (S1), Clapham, Colonel Light Gardens, Daw Park, Hawthorn West, Kingswood, Mitcham, Netherby, Panorama, Pasadena (S3), Westbourne Park.

District of West Torrens

Brooklyn Park, Brooklyn Park South, Camden Park, Cowandilla (S2), Lockleys (S2), Lockleys North, Mile End, Netley, Novar Gardens (S2), Plympton West (S2), Torrensville, West Beach, West Richmond.

District of Wright

Golden Grove Central, Golden Grove East, Greenwith (S1), Greenwith West (S2), Gulfview Heights, Salisbury East, Salisbury East Central, Salisbury Heights South, Wynn Vale, Wynn Vale West (S1).

Polling places with '(S1)', '(S2)' or '(S3)' denotes a shared polling location where more than one district polling booth will be established.

Dated 4 February 2010.

K.M. MOUSLEY, Electoral Commissioner

ECSA 138/09

ENVIRONMENT PROTECTION ACT 1993

Approval of Category B Containers

I, ANDREA KAYE WOODS, Team Leader, Container Deposit Legislation and Delegate of the Environment Protection Authority ('the Authority'), pursuant to section 68 of the Environment Protection Act 1993 (SA) ('the Act') hereby:

Approval of Category B Containers

Approve as Category B Containers, subject to the conditions in subclauses (1), (2), (3) and (4) below, each of the classes of containers identified by reference to the following matters described in the first 4 columns of Schedule 1 of this Notice which are sold in South Australia:

- (a) the product which each class of containers shall contain;
 - (b) the size of the containers;
 - (c) the type of containers; and
 - (d) the name of the holders of these approvals.
- (1) That containers of the class to which the approval relates must bear the refund marking specified by the Authority for containers of that class.
 - (2) The holder of the approval must have in place an effective and appropriate waste management arrangement in relation to containers of that class. For the purpose of this approval notice the company named in Column 5 of Schedule 1 of this Notice is the nominated super collector.
 - (3) In the case of an approval in relation to Category B containers that the waste management arrangement must require the holder of the approval to provide specified super collectors with a declaration in the form determined by the Authority in relation to each sale of such containers by the holder of the approval as soon as practicable after the sale.
 - (4) The holder of these approvals must ensure that if a sticker bearing the refund marking has been approved and is applied to the container, then the sticker must not be placed on any portion of the opening mechanism or in any other place that would require complete or partial removal of the sticker before the contents may be consumed.

SCHEDULE 1

Column 1	Column 2	Column 3	Column 4	Column 5
Product Name	Container Size (mL)	Container Type	Approval Holder	Collection Arrangements
Dr Pepper Cherry	355	Can—Aluminium	AVO Trading Pty Ltd	Statewide Recycling
Mountain Dew Code Red	355	Can—Aluminium	AVO Trading Pty Ltd	Statewide Recycling
Mountain Dew Voltage	355	Can—Aluminium	AVO Trading Pty Ltd	Statewide Recycling
Lobethal Bierhaus Devils Choice	750	Glass	Adelaide Hills Craft Brewing Pty Ltd (trading as Lobethal Bierhaus)	Marine Stores Ltd
Kokozo Grape Fruit Drink	500	PET	Asian Food Wholesalers	Statewide Recycling
Kokozo Lychee Fruit Drink	500	PET	Asian Food Wholesalers	Statewide Recycling
Kokozo Melon Fruit Drink	500	PET	Asian Food Wholesalers	Statewide Recycling
Kokozo Mixed Fruit Drink	500	PET	Asian Food Wholesalers	Statewide Recycling
Kokozo Orange Fruit Drink	500	PET	Asian Food Wholesalers	Statewide Recycling
Kokozo Pomegranate Fruit Drink	500	PET	Asian Food Wholesalers	Statewide Recycling
Kokozo Strawberry Fruit Drink	500	PET	Asian Food Wholesalers	Statewide Recycling
Black Barrel Kentucky Straight Bourbon Whiskey And Cola	470	Can—Aluminium	BDS Marketing	Statewide Recycling
Barbican Premium Malt Apple Flavour	330	Glass	Budget Trading Pty Ltd	Marine Stores Ltd
Barbican Premium Malt Flavour	330	Glass	Budget Trading Pty Ltd	Marine Stores Ltd
Barbican Premium Malt Lemon Flavour	330	Glass	Budget Trading Pty Ltd	Marine Stores Ltd
Barbican Premium Malt Strawberry Flavour	330	Glass	Budget Trading Pty Ltd	Marine Stores Ltd
Barbican Premium Malt Peach Flavour	330	Glass	Budget Trading Pty Ltd	Marine Stores Ltd
Mutual Community 100% Pure Apple Juice	300	PET	Bupa Australia Health Pty Ltd (trading as Mutual Community)	Flagcan Distributors
Bisleri Chinotto	300	Glass	Coca Cola Amatil (Aust.) Pty Ltd	Statewide Recycling
Fanta Lime	200	Can—Aluminium	Coca Cola Amatil (Aust.) Pty Ltd	Statewide Recycling
Fanta Raspberry	450	PET	Coca Cola Amatil (Aust.) Pty Ltd	Statewide Recycling
Fanta Raspberry	200	Can—Aluminium	Coca Cola Amatil (Aust.) Pty Ltd	Statewide Recycling
Goulburn Valley Fruity Drink Apple Blackcurrant	250	PET	Coca Cola Amatil (Aust.) Pty Ltd	Statewide Recycling
Goulburn Valley Fruity Drink Orange	250	PET	Coca Cola Amatil (Aust.) Pty Ltd	Statewide Recycling
Goulburn Valley Fruity Drink Tropical	250	PET	Coca Cola Amatil (Aust.) Pty Ltd	Statewide Recycling
Mother	330	Can—Aluminium	Coca Cola Amatil (Aust.) Pty Ltd	Statewide Recycling
Coopers Clear	355	Glass	Coopers Brewery Ltd	Marine Stores Ltd
Coopers Clear	355	Can—Aluminium	Coopers Brewery Ltd	Marine Stores Ltd
Smirnoff Vodka Mule Ginger Beer & Lime	355	Can—Aluminium	Diageo Australia Pty Ltd	Statewide Recycling
Smirnoff Vodka Mule Ginger Beer & Lime	375	Glass	Diageo Australia Pty Ltd	Statewide Recycling

Column 1	Column 2	Column 3	Column 4	Column 5
Product Name	Container Size (mL)	Container Type	Approval Holder	Collection Arrangements
Caprio Apple Raspberry	2 000	LPB—Aseptic	F & G Kruse Global Trading	Marine Stores Ltd
Caprio Multivitamin	2 000	LPB—Aseptic	F & G Kruse Global Trading	Marine Stores Ltd
Caprio Orange	2 000	LPB—Aseptic	F & G Kruse Global Trading	Marine Stores Ltd
Caprio Pink Grapefruit	2 000	LPB—Aseptic	F & G Kruse Global Trading	Marine Stores Ltd
Tymbark Fruit of the World Coconut	1 000	LPB—Aseptic	F & G Kruse Global Trading	Marine Stores Ltd
Tymbark Fruit of the World Green Banana	1 000	LPB—Aseptic	F & G Kruse Global Trading	Marine Stores Ltd
Tymbark Fruit of the World Lime	1 000	LPB—Aseptic	F & G Kruse Global Trading	Marine Stores Ltd
Tymbark Fruit of the World Pomegranate	1 000	LPB—Aseptic	F & G Kruse Global Trading	Marine Stores Ltd
Matilda Bay Big Helga	345	Glass	Fosters Australia	Marine Stores Ltd
Brown Bomber Oak Aged Brown Ale	500	Glass	Fresh Cellars Trading as Brewboys	Marine Stores Ltd
Hottest 100 Stout	330	Glass	Fresh Cellars Trading as Brewboys	Marine Stores Ltd
Franziskaner Hefe Weissbier Dunkel	500	Glass	German Beverage Imports Pty Ltd	Marine Stores Ltd
Franziskaner Hefe Weissbier Hell	500	Glass	German Beverage Imports Pty Ltd	Marine Stores Ltd
Bon Chiens Beard And Brau Farmhouse Ale	330	Glass	Harlow And Herring Enterprises Pty Ltd	Statewide Recycling
Playboy Energy Drink	250	Can—Aluminium	Island Beverages Ltd	Statewide Recycling
Playboy Sugar Free Energy Drink	250	Can—Aluminium	Island Beverages Ltd	Statewide Recycling
Leather Jacket Lager	330	Glass	Latitude 28 (N.S.W.) Pty Ltd	Marine Stores Ltd
Red Emperor Amber Ale	330	Glass	Latitude 28 (N.S.W.) Pty Ltd	Marine Stores Ltd
Becks	330	Can—Aluminium	Lion Nathan Australia Limited	Marine Stores Ltd
Maxx Blonde Premium Lager	330	Can—Aluminium	Liquorland Aust Pty Ltd	Statewide Recycling
Devondale Moo Chocolate Milk	200	Liquid Paper Board	Murray Goulburn Co-operative Limited	Statewide Recycling
Maximol Solutions	90	HDPE	Neways International Australia Pty Ltd	Statewide Recycling
DIY Vitamin Water Recover Mixed Berry Zero Sugar	620	PET	Nu Pure Pty Ltd	Statewide Recycling
DIY Vitamin Water Refresh Lime & Vanilla Zero Sugar	620	PET	Nu Pure Pty Ltd	Statewide Recycling
DIY Vitamin Water Revive Grape & Kiwi Zero Sugar	620	PET	Nu Pure Pty Ltd	Statewide Recycling
Pure Natural Mineral Water Sparkling	500	Glass	Nu Pure Pty Ltd	Statewide Recycling
The Coffee Club Sparkling Spring Water	500	Glass	Nu Pure Pty Ltd	Statewide Recycling
drinkup all natural spring water	620	PET	Nu Pure Pty Ltd	Statewide Recycling
drinkup all natural spring water	1 000	PET	Nu Pure Pty Ltd	Statewide Recycling
drinkup all natural spring water	1 500	PET	Nu Pure Pty Ltd	Statewide Recycling
Nudie Crushie Green Crushie	250	PET	Nudie Foods Pty Ltd	Statewide Recycling
Nudie Crushie Pomegranate & Apple Crushie	250	PET	Nudie Foods Pty Ltd	Statewide Recycling
Better Water	575	PET	Nutrientwater Pty Ltd (formerly Natureau Pty Ltd)	Statewide Recycling
NWX Nutrient Water A Game Super Low Calorie	575	PET	Nutrientwater Pty Ltd (formerly Natureau Pty Ltd)	Statewide Recycling
NWX Nutrient Water Refocus Super Low Calorie	575	PET	Nutrientwater Pty Ltd (formerly Natureau Pty Ltd)	Statewide Recycling
Coles Apple & Berry Mineral Water	1 250	PET	P & N Beverages Australia Pty Ltd	Flagcan Distributors
Coles Cola	2 000	PET	P & N Beverages Australia Pty Ltd	Flagcan Distributors
Coles Lemon & Lime Mineral Water	1 250	PET	P & N Beverages Australia Pty Ltd	Flagcan Distributors
Coles Lemon Mineral Water	1 250	PET	P & N Beverages Australia Pty Ltd	Flagcan Distributors
Coles Lemonade	2 000	PET	P & N Beverages Australia Pty Ltd	Flagcan Distributors
Coles Natural Mineral Water	1 250	PET	P & N Beverages Australia Pty Ltd	Flagcan Distributors
Coles Orange & Mango Mineral Water	1 250	PET	P & N Beverages Australia Pty Ltd	Flagcan Distributors

Column 1	Column 2	Column 3	Column 4	Column 5
Product Name	Container Size (mL)	Container Type	Approval Holder	Collection Arrangements
Coles Pine & Mango Mineral Water	1 250	PET	P & N Beverages Australia Pty Ltd	Flagcan Distributors
Tru Blu Ceda Creaming Soda	300	PET	P & N Beverages Australia Pty Ltd	Flagcan Distributors
Tru Blu Crush Lime	300	PET	P & N Beverages Australia Pty Ltd	Flagcan Distributors
Tru Blu Crush Orange	300	PET	P & N Beverages Australia Pty Ltd	Flagcan Distributors
Tru Blu Crush Passion	2 000	PET	P & N Beverages Australia Pty Ltd	Flagcan Distributors
Tru Blu Diet Squash Lemon Soda Squash	300	PET	P & N Beverages Australia Pty Ltd	Flagcan Distributors
Tru Blu Lido Lemonade	300	PET	P & N Beverages Australia Pty Ltd	Flagcan Distributors
Tru Blu McSars Double Sars Sarsaparilla	1 250	PET	P & N Beverages Australia Pty Ltd	Flagcan Distributors
Tru Blu Pub Squash Lemon Soda Squash	300	PET	P & N Beverages Australia Pty Ltd	Flagcan Distributors
Orchy Apple & Blackcurrant Juice	200	PET	Parmalat Food Products Pty Ltd	Statewide Recycling
Orchy Apple & Blackcurrant Juice	500	PET	Parmalat Food Products Pty Ltd	Statewide Recycling
Orchy Apple & Blackcurrant Juice	375	PET	Parmalat Food Products Pty Ltd	Statewide Recycling
Orchy Apple Juice	200	PET	Parmalat Food Products Pty Ltd	Statewide Recycling
Orchy Apple Juice	375	PET	Parmalat Food Products Pty Ltd	Statewide Recycling
Orchy Apple Juice	500	PET	Parmalat Food Products Pty Ltd	Statewide Recycling
Orchy Apple Juice	300	PET	Parmalat Food Products Pty Ltd	Statewide Recycling
Orchy Apple Mango & Banana Juice	375	PET	Parmalat Food Products Pty Ltd	Statewide Recycling
Orchy Orange & Mango Juice	500	PET	Parmalat Food Products Pty Ltd	Statewide Recycling
Orchy Orange Juice	200	PET	Parmalat Food Products Pty Ltd	Statewide Recycling
Orchy Orange Juice	375	PET	Parmalat Food Products Pty Ltd	Statewide Recycling
Orchy Orange Juice	500	PET	Parmalat Food Products Pty Ltd	Statewide Recycling
Orchy Orange Juice	300	PET	Parmalat Food Products Pty Ltd	Statewide Recycling
Orchy Orange Mango 35% Nectar	500	PET	Parmalat Food Products Pty Ltd	Statewide Recycling
Orchy Orange Mango 35% Nectar	2 000	HDPE	Parmalat Food Products Pty Ltd	Statewide Recycling
Orchy Orange Passio 35% Nectar	500	PET	Parmalat Food Products Pty Ltd	Statewide Recycling
Orchy Orange Passio 35% Nectar	2 000	HDPE	Parmalat Food Products Pty Ltd	Statewide Recycling
Orchy Orange Passionfruit Juice	200	PET	Parmalat Food Products Pty Ltd	Statewide Recycling
Orchy Premium Orange Juice	375	PET	Parmalat Food Products Pty Ltd	Statewide Recycling
Orchy Premium Orange Juice	500	PET	Parmalat Food Products Pty Ltd	Statewide Recycling
Pure Active Natural Spring Water	600	PET	Parmalat Food Products Pty Ltd	Statewide Recycling
Paulaner Munich Lager	330	Glass	Samuel Smith & Son Pty Ltd	Statewide Recycling
Paulaner Weiss Bier	330	Glass	Samuel Smith & Son Pty Ltd	Statewide Recycling
Jones Pure Cane Soda Cherry	355	Glass	Siena Foods Pty Ltd	Statewide Recycling
Jones Pure Cane Soda Grape	355	Glass	Siena Foods Pty Ltd	Statewide Recycling
Jones Pure Cane Soda Orange & Cream	355	Glass	Siena Foods Pty Ltd	Statewide Recycling
Jones Sugar Cane Soda Blue Bubble Gum	355	Glass	Siena Foods Pty Ltd	Statewide Recycling
Jones Sugar Cane Soda Cream Soda	355	Glass	Siena Foods Pty Ltd	Statewide Recycling
Jones Sugar Cane Soda Fufu Berry	355	Glass	Siena Foods Pty Ltd	Statewide Recycling
Jones Sugar Cane Soda Green Apple	355	Glass	Siena Foods Pty Ltd	Statewide Recycling
Jones Sugar Cane Soda Root Beer	355	Glass	Siena Foods Pty Ltd	Statewide Recycling
Dos Equis Ambar	330	Glass	Six Star Breweries	Marine Stores Ltd
BMW Natural Spring Water	600	PET	Springwater Beverages Pty Ltd	Statewide Recycling
Bendigo And Adelaide Bank Spring Water	600	PET	Springwater Beverages Pty Ltd	Statewide Recycling

Column 1	Column 2	Column 3	Column 4	Column 5
Product Name	Container Size (mL)	Container Type	Approval Holder	Collection Arrangements
Mini Natural Spring Water	600	PET	Springwater Beverages Pty Ltd	Statewide Recycling
Rehabit Natural Spring Water	600	PET	Springwater Beverages Pty Ltd	Statewide Recycling
Stratco Natural Spring Water	600	PET	Springwater Beverages Pty Ltd	Statewide Recycling
Fusion H2O	600	PET	The Fusion Group Perth Pty Ltd	Statewide Recycling
Fusion H2O	1 500	PET	The Fusion Group Perth Pty Ltd	Statewide Recycling
PEP2GO	500	PET	Vitality Brands Worldwide Pty Ltd	Statewide Recycling

GOVERNMENT GAZETTE ADVERTISEMENT RATES

To apply from 1 July 2009

	\$		\$
Agents, Ceasing to Act as.....	42.75	Firms:	
Associations:		Ceasing to Carry on Business (each insertion).....	28.50
Incorporation	21.70	Discontinuance Place of Business	28.50
Intention of Incorporation	53.50	Land—Real Property Act:	
Transfer of Properties	53.50	Intention to Sell, Notice of.....	53.50
Attorney, Appointment of.....	42.75	Lost Certificate of Title Notices	53.50
Bailiff's Sale.....	53.50	Cancellation, Notice of (Strata Plan)	53.50
Cemetery Curator Appointed.....	31.75	Mortgages:	
Companies:		Caveat Lodgement.....	21.70
Alteration to Constitution	42.75	Discharge of.....	22.70
Capital, Increase or Decrease of	53.50	Foreclosures.....	21.70
Ceasing to Carry on Business	31.75	Transfer of	21.70
Declaration of Dividend.....	31.75	Sublet.....	10.90
Incorporation	42.75	Leases—Application for Transfer (2 insertions) each	10.90
Lost Share Certificates:		Lost Treasury Receipts (3 insertions) each.....	31.75
First Name.....	31.75	Licensing.....	63.50
Each Subsequent Name.....	10.90	Municipal or District Councils:	
Meeting Final.....	35.75	Annual Financial Statement—Forms 1 and 2	598.00
Meeting Final Regarding Liquidator's Report on		Electricity Supply—Forms 19 and 20.....	425.00
Conduct of Winding Up (equivalent to 'Final		Default in Payment of Rates:	
Meeting')		First Name	85.00
First Name.....	42.75	Each Subsequent Name.....	10.90
Each Subsequent Name.....	10.90	Noxious Trade.....	31.75
Notices:		Partnership, Dissolution of	31.75
Call.....	53.50	Petitions (small).....	21.70
Change of Name	21.70	Registered Building Societies (from Registrar-	
Creditors.....	42.75	General).....	21.70
Creditors Compromise of Arrangement	42.75	Register of Unclaimed Moneys—First Name.....	31.75
Creditors (extraordinary resolution that 'the Com-		Each Subsequent Name	10.90
pany be wound up voluntarily and that a liquidator		Registers of Members—Three pages and over:	
be appointed').....	53.50	Rate per page (in 8pt)	272.00
Release of Liquidator—Application—Large Ad.....	85.00	Rate per page (in 6pt)	359.00
—Release Granted	53.50	Sale of Land by Public Auction.....	54.00
Receiver and Manager Appointed.....	49.50	Advertisements.....	3.00
Receiver and Manager Ceasing to Act.....	42.75	¼ page advertisement	127.00
Restored Name.....	40.00	½ page advertisement	254.00
Petition to Supreme Court for Winding Up.....	74.50	Full page advertisement.....	498.00
Summons in Action.....	63.50	Advertisements, other than those listed are charged at \$3.00 per	
Order of Supreme Court for Winding Up Action.....	42.75	column line, tabular one-third extra.	
Register of Interests—Section 84 (1) Exempt.....	96.00	Notices by Colleges, Universities, Corporations and District	
Removal of Office.....	21.70	Councils to be charged at \$3.00 per line.	
Proof of Debts	42.75	Where the notice inserted varies significantly in length from	
Sales of Shares and Forfeiture.....	42.75	that which is usually published a charge of \$3.00 per column line	
Estates:		will be applied in lieu of advertisement rates listed.	
Assigned	31.75	South Australian Government publications are sold on the	
Deceased Persons—Notice to Creditors, etc.....	53.50	condition that they will not be reproduced without prior	
Each Subsequent Name.....	10.90	permission from the Government Printer.	
Deceased Persons—Closed Estates	31.75		
Each Subsequent Estate	1.40		
Probate, Selling of	42.75		
Public Trustee, each Estate	10.90		

All the above prices include GST

GOVERNMENT GAZETTE NOTICES

ALL private advertisements forwarded for publication in the *South Australian Government Gazette* must be PAID FOR PRIOR TO INSERTION; and all notices, from whatever source, should be legibly written on one side of the paper only and sent to **Government Publishing SA** so as to be *received no later than 4 p.m. Tuesday preceding the day of publication. Phone 8207 1045 or Fax 8207 1040. E-mail: governmentgazette@dpc.sa.gov.au*. Send as attachments in Word format. Please include date the notice is to be published and to whom the notice will be charged. **The Government Gazette is available online at: www.governmentgazette.sa.gov.au.**

MISCELLANEOUS LEGISLATION AND GOVERNMENT PUBLICATIONS PRICES AS FROM 1 JULY 2009

Acts, Bills, Rules, Parliamentary Papers and Regulations					
Pages	Main	Amends	Pages	Main	Amends
1-16	2.60	1.20	497-512	36.25	35.25
17-32	3.50	2.20	513-528	37.25	36.00
33-48	4.55	3.25	529-544	38.50	37.25
49-64	5.75	4.40	545-560	39.50	38.50
65-80	6.70	5.55	561-576	40.50	39.50
81-96	7.80	6.45	577-592	41.75	40.00
97-112	8.90	7.60	593-608	43.00	41.50
113-128	9.95	8.75	609-624	43.75	42.75
129-144	11.10	9.85	625-640	45.00	43.25
145-160	12.20	10.90	641-656	46.00	45.00
161-176	13.30	12.00	657-672	46.75	45.50
177-192	14.50	13.10	673-688	48.75	46.75
193-208	15.60	14.40	689-704	49.50	47.75
209-224	16.50	15.20	705-720	50.25	49.00
225-240	17.60	16.30	721-736	52.00	50.00
241-257	18.90	17.20	737-752	52.50	51.00
258-272	19.90	18.30	753-768	53.50	52.00
273-288	21.00	19.70	769-784	54.50	53.50
289-304	21.90	20.60	785-800	55.50	54.50
305-320	23.20	21.80	801-816	57.00	55.00
321-336	24.20	22.80	817-832	58.00	57.00
337-352	25.40	24.10	833-848	59.00	58.00
353-368	26.25	25.20	849-864	60.00	58.50
369-384	27.50	26.25	865-880	61.50	60.00
385-400	28.75	27.25	881-896	62.00	60.50
401-416	29.75	28.25	897-912	63.50	62.00
417-432	31.00	29.50	913-928	64.00	63.50
433-448	32.00	30.75	929-944	65.00	64.00
449-464	32.75	31.50	945-960	66.00	64.50
465-480	33.25	32.50	961-976	68.50	65.50
481-496	35.25	33.25	977-992	69.50	66.00

Legislation—Acts, Regulations, etc:

Subscriptions:

Acts	\$ 223.00
All Bills as Laid	536.00
Rules and Regulations	536.00
Parliamentary Papers	536.00
Bound Acts	248.00
Index	124.00

Government Gazette

Copy	5.85
Subscription	296.00

Hansard

Copy	16.30
Subscription—per session (issued weekly)	465.00
Cloth bound—per volume	199.00
Subscription—per session (issued daily)	465.00

Legislation on Disk

Whole Database	3 443.00
Annual Subscription for fortnightly updates	1 058.00
Individual Act(s) including updates	POA

Notice of Vacancies

Annual Subscription	164.00
---------------------------	--------

Compendium

Subscriptions:

New Subscriptions	2 039.00
Updates	719.00

(All the above prices include GST)

All Legislation, Government Gazette, Hansard and Legislation on disk are available from:

**Counter Sales
and Mail Orders:****Government Legislation⁺ Outlet**

Service SA Customer Service Centre,
Ground Floor—EDS Centre, 108 North Terrace, Adelaide, S.A. 5000
Phone: 13 23 24 (local call cost), Fax: (08) 8204 1909
Postal: G.P.O. Box 1707, Adelaide, S.A. 5001

Online Shop:**www.shop.service.sa.gov.au****Subscriptions and
Standing Orders:****Government Publishing SA**

Box 9, Plaza Level, Riverside Centre, North Terrace, Adelaide, S.A. 5000
Phone: (08) 8207 1043, (08) 8207 0910, Fax: (08) 8207 1040

FIREARMS ACT 1977

SECTION 21C

Recognised Firearms Clubs

I DECLARE the SSAA (SA) Monarto Black Powder and Shooters Club, to be a recognised firearms club pursuant to the Firearms Act 1977.

Dated 30 November 2009.

MICHAEL WRIGHT, Minister for Police

FISHERIES MANAGEMENT ACT 2007: SECTION 115

TAKE notice that pursuant to section 115 of the Fisheries Management Act 2007, Dr Tim O'Hara of the Museum Victoria, G.P.O. 666, Melbourne, Vic. 3001 (the 'exemption holder') or a person acting as his agent, is exempt from Clause 118 of Schedule 6 of the Fisheries Management (General) Regulations 2007, but only insofar as they may engage in the collection of Echinoderms from the waters specified in Schedule 1 (the 'exempted activity'), subject to the conditions set out in Schedule 2, from 1 February 2010 until 28 February 2010, unless this notice is varied or revoked earlier.

SCHEDULE 1

South Australian coastal waters (including intertidal 'rocky' reef areas but excluding aquatic reserves) adjacent to Victor Harbor, Robe, Beachport, Southend and Port MacDonnell.

SCHEDULE 2

1. The specimens collected by the exemption holder are for scientific and research purposes only and must not be sold. Any unwanted specimens must be returned to the water immediately.

2. Specimens may only be collected by hand and either by snorkelling or diving.

3. The exemption holder or a person acting as his agent may only collect Echinoderms of the following species:

- *Tosia australis*;
- *Tosia neossia*;
- *Ophionereis schayeri*;
- *Clarkcoma canaliculata*;
- *Cenolia tasmaniae*; and
- *Cenolia trichoptera*.

4. A maximum of 10 specimens from each species may be collected from any one site.

5. Any species collected that are not returned to the water must be lodged as voucher specimens with Museum Victoria.

6. The exemption holder must notify PIRSA Fishwatch on 1800 065 522 at least two hours prior to conducting the exempted activity and answer a series of questions about the exempted activity. The exemption holder will need to have a copy of the exemption at the time of making the call and be able to provide information about the area and time of the exempted activity, the vehicles and boats involved, the number of agents undertaking the exempted activity and other related questions. Exemption No. 9902321.

7. The exempted activity may only be conducted on the exemption holder's behalf by Kate Naughton.

8. The exemption holder must provide a written report to the Director of Fisheries (G.P.O. Box 1625, Adelaide, S.A. 5001), within 14 days of the completion of each collection made pursuant to this exemption, providing details of the numbers, location and time of the collection.

9. While engaged in the exempted activity, the exemption holder or an agent of the exemption holder must be in possession of a copy of this notice. Such notice must be produced to a PIRSA Fisheries Compliance Officer upon request.

10. A person undertaking the exempted activity must not contravene or fail to comply with the Fisheries Management Act 2007 or any regulations made under that Act, except where specifically exempted by this notice.

Dated 27 January 2010.

M. SMALLRIDGE, Director of Fisheries

FISHERIES MANAGEMENT ACT 2007: SECTION 79

TAKE notice that it will be unlawful for any person to engage in the class of fishing activity specified in Schedule 1, during the period specified in Schedule 2.

SCHEDULE 1

The act of taking or the act preparatory to or involved in the taking of King Prawn (*Melicertus latisulcatus*) in all waters of the Spencer Gulf Prawn Fishery.

SCHEDULE 2

From 2000 hours on 1 February 2010 to 0600 hours on 31 January 2011.

Dated 1 February 2010.

A. FISTR, Prawn Fishery Manager

FISHERIES MANAGEMENT ACT 2007: SECTION 79

TAKE notice that it will be unlawful for any person to engage in the class of fishing activity specified in Schedule 1, during the period specified in Schedule 2.

SCHEDULE 1

The act of taking or the act preparatory to or involved in the taking of King Prawn (*Melicertus latisulcatus*) in all waters of the Gulf St Vincent Prawn Fishery.

SCHEDULE 2

From 0600 hours on 1 February 2010 to 2400 hours on 31 January 2011.

Dated 1 February 2010.

A. FISTR, Prawn Fishery Manager

FISHERIES MANAGEMENT ACT 2007: SECTION 79

TAKE notice that it is hereby declared that it shall be unlawful for any person to engage in the class of fishing activity specified in Schedule 1 during the period specified in Schedule 2.

SCHEDULE 1

The act of taking or the act preparatory to or involved in the taking of King Prawn (*Melicertus latisulcatus*) in all waters of the West Coast Prawn Fishery.

SCHEDULE 2

From 0600 hours on 1 February 2010 to 0600 hours on 31 January 2011.

Dated 1 February 2010.

A. FISTR, Prawn Fishery Manager

GEOGRAPHICAL NAMES ACT 1991

Notice to Assign the Names to Places

NOTICE is hereby given, pursuant to the provisions of the above Act, that I, Patrick Conlon, Minister for Infrastructure, Minister of the Crown to whom the administration of the Geographical Names Act 1991 is committed DO HEREBY create the boundaries of places as listed below and shown on Rack Plan 935.

1. Assign the name **DOUGLAS POINT** to that area marked (A) as shown on the plan.

2. Assign the name **DOUGLAS POINT SOUTH** to that area marked (B) as shown on the plan.

3. Assign the name **BACKY POINT** to that area marked (C) as shown on the plan.

4. Assign the name **FITZGERALD BAY** to that area marked (D) as shown on the plan.

5. Assign the name **POINT LOWLY NORTH** to that area marked (E) as shown on the plan.

6. Exclude from the bounded locality of **POINT LOWLY** and include into the bounded locality of **PORT BONYTHON** that area marked (F) as shown on the plan.

7. Assign the name **FALSE BAY** to that area marked (G) as shown on the plan.

PATRICK CONLON, Minister for Infrastructure

DTEI.22-413/09/0002

HEALTH CARE ACT 2008

Notice by the Minister

TAKE notice that I, John Hill, Minister for Health, do hereby:

1. Pursuant to section 15 (1) of the Health Care Act 2008, establish the Health and Medical Research Advisory Council as a Health Advisory Council.

2. Pursuant to section 15 (3) (a) of the Health Care Act 2008, designate the Minister for Health, the Chief Executive of the Department of Health and the Department of Health to be the entities in relation to which the Health and Medical Research Advisory Council is established.

3. Pursuant to section 15 (3) (c) of the Health Care Act 2008, assign the name Health and Medical Research Advisory Council to the Health Advisory Council and declare that the Health and Medical Research Advisory Council will be an unincorporated body.

4. Pursuant to section 15 (3) (b) and 15 (3) (d) of the Health Care Act 2008, provide that the Health and Medical Research Advisory Council will have the powers and functions set out in the rules determined by me in accordance with section 17 of the Health Care Act 2008.

Dated 25 January 2010.

JOHN HILL, Minister for Health

HIGHWAYS ACT 1926
SECTION 26 (3)*Notice*

THIS notice for Road Number 05420 supersedes the section 26 (3) Notice dated 11 September 2001, *Government Gazette* No.115, for Road Number 05420, then comprising part Bedford Street, Kapara Road and part North Arm Road, within the boundaries of the City of Port Adelaide Enfield, as a result of Bedford Street being assigned a new road number (RN54009) and now subject to a separate section 26 (3) Notice.

I, Andrew John Milazzo, delegate of the Commissioner of Highways, with the approval of the Minister for Transport and pursuant to my delegated powers under section 12A of the Highways Act 1926, do hereby give notice that:

- (1) I will continue to undertake the care, control and management of Road Number 05420, now comprising Kapara Road and part North Arm Road, from the junction with Bedford Street to the junction with Cormack Road, within the boundaries of the City of Port Adelaide Enfield, until further notice.
- (2) This notice, when read in conjunction with the section 26 (3) Notice of the same date for Bedford Street (RN54009), results in no change to the responsibilities assumed by the Commissioner of Highways.

Dated 27 January 2010.

A. J. MILAZZO, Commissioner of Highways
Delegate

HIGHWAYS ACT 1926
SECTION 26 (3)*Notice*

THIS notice for Road Number 54009, known as Bedford Street, within the boundaries of the City of Port Adelaide Enfield, supersedes in part the section 26 (3) Notice dated 11 September 2001, *Government Gazette* No. 115, for Road Number 05420, then comprising part Bedford Street, Kapara Road and part North Arm Road, as a result of Bedford Street being assigned a new road number (RN54009).

I, Andrew John Milazzo, delegate of the Commissioner of Highways, with the approval of the Minister for Transport and pursuant to my delegated powers under section 12A of the Highways Act 1926, do hereby give notice that:

- (1) I will continue to undertake the care, control and management of that part of Road Number 54009, known as Bedford Street, from the intersection with Eastern Parade to the junction with Kapara Road, within the boundaries of the City of Port Adelaide Enfield, until further notice.

- (2) This notice, when read in conjunction with the section 26 (3) Notice of the same date re-issued for Road Number 05420, now comprising Kapara Road and part North Arm Road only, results in no change to the responsibilities assumed by the Commissioner of Highways.

Dated 27 January 2010.

A. J. MILAZZO, Commissioner of Highways
Delegate

LIQUOR LICENSING ACT 1997

Notice of Application

NOTICE is hereby given, pursuant to section 52 (2) (b) of the Liquor Licensing Act 1997, that Sophie Kate Newland has applied to the Licensing Authority for the transfer of a Restaurant Licence, Section 34 (1) (c) in respect of premises situated at 43 North Terrace, Penneshaw, S.A. 5222 and known as Isola Pizza.

The application has been set down for hearing on 23 February 2010 at 11.30 a.m.

Conditions

The following licence conditions are sought:

- Approval under Section 34 (1) (c) to sell liquor without meals for consumption on the licensed premises by persons:

(a) Seated at a table; or

(b) Attending a function at which food is provided.

- Redefinition to include veranda area as per plans lodged with this office.
- Extended Trading Authorisation is sought for the whole of the premises including the above mentioned area for the following day and times:

Sunday: 8 a.m. to 11 a.m. and 8 p.m. to midnight.

Any person may object to the application by lodging a notice of objection in the prescribed form with the Liquor and Gambling Commissioner and serving a copy of the notice on the applicant at the applicant's address, before the hearing date (viz: 22 February 2010).

The applicant's address for service is c/o Wallmans Lawyers, G.P.O Box 1018, Adelaide, S.A. 5001 (Attention: Ben Allen or Sam Ngai).

Plans in respect of the premises the subject of the application are open to public inspection without fee at the Office of the Liquor and Gambling Commissioner, 9th Floor, East Wing, 50 Grenfell Street, Adelaide, S.A. 5000. Phone 8226 8410, Fax: 8226 8512. Email: olgc@agd.sa.gov.au.

Dated 27 January 2010.

Applicant

LIQUOR LICENSING ACT 1997

Notice of Application

NOTICE is hereby given, pursuant to section 52 (2) (b) of the Liquor Licensing Act 1997, that Hindley Holdings Pty Ltd has applied to the Licensing Authority for the transfer of a Special Circumstances Licence in respect of premises situated at 114 Hindley Street, Adelaide, S.A. 5000 and known as the Basement Bar.

The application has been set down for hearing on 24 February 2010 at 11.30 a.m.

Any person may object to the application by lodging a notice of objection in the prescribed form with the Liquor and Gambling Commissioner and serving a copy of the notice on the applicant at the applicant's address, at least seven days before the hearing date (viz: 17 February 2010).

The applicant's address for service is c/o James Packham, 234A Hindley Street, Adelaide, S.A. 5000.

Plans in respect of the premises the subject of the application are open to public inspection without fee at the Office of the

Liquor and Gambling Commissioner, 9th Floor, East Wing, 50 Grenfell Street, Adelaide, S.A. 5000. Phone 8226 8410, Fax: 8226 8512. Email: olgc@agd.sa.gov.au.

Dated 29 January 2010.

Applicant

LIQUOR LICENSING ACT 1997

Notice of Application

NOTICE is hereby given, pursuant to section 52 (2) (b) of the Liquor Licensing Act 1997, that Hasbeen Pty Ltd as trustee for Thompson Family Trust No. 4, Lot 112, Old Comaum Road, Coonawarra, S.A. 5263, has applied to the Licensing Authority for a Direct Sales Licence in respect of the business to be known as Hasbeen Pty Ltd.

The application has been set down for hearing on 25 February 2010 at 10.30 a.m.

Any person may object to the application by lodging a notice of objection in the prescribed form with the Liquor and Gambling Commissioner and serving a copy of the notice on the applicant at the applicant's address, at least seven days before the hearing date (viz: 18 February 2010).

The applicant's address for service is c/o Wallmans Lawyers, G.P.O. Box 1018, Adelaide, S.A. 5001 (Attention: Ben Allen or Sam Ngai).

Plans in respect of the premises the subject of the application are open to public inspection without fee at the Office of the Liquor and Gambling Commissioner, 9th Floor, East Wing, 50 Grenfell Street, Adelaide, S.A. 5000. Phone 8226 8410, Fax: 8226 8512. Email: olgc@agd.sa.gov.au.

Dated 25 January 2010.

Applicant

LIQUOR LICENSING ACT 1997

Notice of Application

NOTICE is hereby given, pursuant to section 52 (2) (b) of the Liquor Licensing Act 1997, that Tricep Six Pty Ltd as trustee for Graham Six Family Trust has applied to the Licensing Authority for the transfer of a Hotel Licence in respect of premises situated at Wendouree Road, Clare, S.A. 5433 and known as Salt N Vines Bar & Bistro.

The application has been set down for hearing on 2 March 2010 at 9 a.m.

Any person may object to the application by lodging a notice of objection in the prescribed form with the Liquor and Gambling Commissioner and serving a copy of the notice on the applicant at the applicant's address, at least seven days before the hearing date (viz: 23 February 2010).

The applicant's address for service is c/o Sue Barry Conveyancing, P.O. Box 236, Clare, S.A. 5453 (Attention: Sue Barry).

Plans in respect of the premises the subject of the application are open to public inspection without fee at the Office of the Liquor and Gambling Commissioner, 9th Floor, East Wing, 50 Grenfell Street, Adelaide, S.A. 5000. Phone 8226 8410, Fax: 8226 8512. Email: olgc@agd.sa.gov.au.

Dated 28 January 2010.

Applicant

LIQUOR LICENSING ACT 1997

Notice of Application

NOTICE is hereby given, pursuant to section 52 (2) (b) of the Liquor Licensing Act 1997, that Anthony Robert Turner and Joanne Robyn Schultz have applied to the Licensing Authority for the transfer of a Restaurant Licence in respect of premises situated at 3 Fiebig Road, Meningie, S.A. 5264 and known as the Cheese Factory Meningie's Museum Restaurant.

The application has been set down for hearing on 2 March 2010 at 9.30 a.m.

Any person may object to the application by lodging a notice of objection in the prescribed form with the Liquor and Gambling Commissioner and serving a copy of the notice on the applicant at the applicant's address, at least seven days before the hearing date (viz: 23 February 2010).

The applicants' address for service is c/o Tony Turner, 32 Bonney Street, Meningie, S.A. 5264.

Plans in respect of the premises the subject of the application are open to public inspection without fee at the Office of the Liquor and Gambling Commissioner, 9th Floor, East Wing, 50 Grenfell Street, Adelaide, S.A. 5000. Phone 8226 8410, Fax: 8226 8512. Email: olgc@agd.sa.gov.au.

Dated 28 January 2010.

Applicants

LIQUOR LICENSING ACT 1997

Notice of Application

NOTICE is hereby given, pursuant to section 52 (2) (b) of the Liquor Licensing Act 1997, that the Sea Wolves Scuba Diving Club Inc. has applied to the Licensing Authority for a Limited Club Licence in respect of premises situated at Bayford Rise, Morphett Vale, S.A. 5162 and to be known as Sea Wolves Dive Club.

The application has been set down for hearing on 2 March 2010 at 10 a.m.

Any person may object to the application by lodging a notice of objection in the prescribed form with the Liquor and Gambling Commissioner and serving a copy of the notice on the applicant at the applicant's address, at least seven days before the hearing date (viz: 23 February 2010).

The applicant's address for service is c/o Sarah Stevens, P.O. Box 178, Old Reynella, S.A. 5162.

Plans in respect of the premises the subject of the application are open to public inspection without fee at the Office of the Liquor and Gambling Commissioner, 9th Floor, East Wing, 50 Grenfell Street, Adelaide, S.A. 5000. Phone 8226 8410, Fax: 8226 8512. Email: olgc@agd.sa.gov.au.

Dated 28 January 2010.

Applicant

LIQUOR LICENSING ACT 1997

Notice of Application

NOTICE is hereby given, pursuant to section 52 (2) (b) of the Liquor Licensing Act 1997, that Quiet Brilliant Pty Ltd as trustee for Quiet Brilliant Unit Trust has applied to the Licensing Authority for a Producer's Licence in respect of premises situated at 4/79 Exeter Terrace, Dudley Park, S.A. 5008 and to be known as Wild Creek Wines.

The application has been set down for hearing on 4 March 2010 at 10.30 a.m.

Any person may object to the application by lodging a notice of objection in the prescribed form with the Liquor and Gambling Commissioner and serving a copy of the notice on the applicant at the applicant's address, at least seven days before the hearing date (viz: 25 February 2010).

The applicant's address for service is c/o Jack Tsakiris, P.O. Box 343, Prospect, S.A. 5082.

Plans in respect of the premises the subject of the application are open to public inspection without fee at the Office of the Liquor and Gambling Commissioner, 9th Floor, East Wing, 50 Grenfell Street, Adelaide, S.A. 5000. Phone 8226 8410, Fax: 8226 8512. Email: olgc@agd.sa.gov.au.

Dated 28 January 2010.

Applicant

LIQUOR LICENSING ACT 1997

Notice of Application

NOTICE is hereby given, pursuant to section 52 (2) (b) of the Liquor Licensing Act 1997, that Bronte Vincent Peter and Alison Mary Peter have applied to the Licensing Authority for a Restaurant Licence in respect of premises situated at 126A Onkaparinga Valley Road, Balhannah, S.A. 5245 and to be known as Kelsey College Cafe and Catering.

The application has been set down for hearing on 8 March 2010 at 11 a.m.

Any person may object to the application by lodging a notice of objection in the prescribed form with the Liquor and Gambling Commissioner and serving a copy of the notice on the applicants at the applicants' address, at least seven days before the hearing date (viz: 1 March 2010).

The applicants' address for service is c/o Bronte Peter, Onkaparinga Valley Road, Balhannah, S.A. 5245.

Plans in respect of the premises the subject of the application are open to public inspection without fee at the Office of the Liquor and Gambling Commissioner, 9th Floor, East Wing, 50 Grenfell Street, Adelaide, S.A. 5000. Phone 8226 8410, Fax: 8226 8512. Email: olgc@agd.sa.gov.au.

Dated 1 February 2010.

Applicants

LIQUOR LICENSING ACT 1997

Notice of Application

NOTICE is hereby given, pursuant to section 52 (2) (b) of the Liquor Licensing Act 1997, that Kismat Investments Pty Ltd has applied to the Licensing Authority for the transfer of a Restaurant Licence in respect of premises situated at Tenancy 34, North Adelaide Village Shopping Centre, 61-83 O'Connell Street, North Adelaide, S.A. 5006 and known as Maple House.

The application has been set down for hearing on 9 March 2010 at 9.30 a.m.

Any person may object to the application by lodging a notice of objection in the prescribed form with the Liquor and Gambling Commissioner and serving a copy of the notice on the applicant at the applicant's address, at least seven days before the hearing date (viz: 2 March 2010).

The applicant's address for service is c/o David Parker, Level 6, 32 Grenfell Street, Adelaide, S.A. 5000.

Plans in respect of the premises the subject of the application are open to public inspection without fee at the Office of the Liquor and Gambling Commissioner, 9th Floor, East Wing, 50 Grenfell Street, Adelaide, S.A. 5000. Phone 8226 8410, Fax: 8226 8512. Email: olgc@agd.sa.gov.au.

Dated 2 February 2010.

Applicant

LIQUOR LICENSING ACT 1997

Notice of Application

NOTICE is hereby given, pursuant to section 52 (2) (b) of the Liquor Licensing Act 1997, that Fantasy Fulfillment Pty Ltd has applied to the Licensing Authority for Variation to Conditions in respect of premises situated at 134 Hindley Street, Adelaide, S.A. 5000 and known as Isobar.

The application has been set down for hearing on 9 March 2010 at 10 a.m.

Conditions

The following licence conditions are sought:

- Variation to Conditions too vary the currently approved licence condition.

From:

Monday to Sunday: 5 p.m. to 5 a.m. the following day.

Christmas Day: 5 p.m. to midnight.

Sunday Christmas Eve: 5 p.m. to midnight.

To:

Monday to Thursday: 5 p.m. to 5 a.m. the following day.

Friday to Saturday: 5 p.m. to 7 a.m. the following day.

Sunday: 5 p.m. to 5 a.m. the following day.

Christmas Day: 5 p.m. to midnight.

Sunday Christmas Eve: 5 p.m. to midnight.

Any person may object to the application by lodging a notice of objection in the prescribed form with the Liquor and Gambling Commissioner and serving a copy of the notice on the applicant at the applicant's address, at least seven days before the hearing date (viz: 2 March 2010).

The applicant's address for service is c/o Geoffrey Yu, 134 Hindley Street, Adelaide, S.A. 5000.

Plans in respect of the premises the subject of the application are open to public inspection without fee at the Office of the Liquor and Gambling Commissioner, 9th Floor, East Wing, 50 Grenfell Street, Adelaide, S.A. 5000. Phone 8226 8410, Fax: 8226 8512. Email: olgc@agd.sa.gov.au.

Dated 2 February 2010.

Applicant

LOCAL GOVERNMENT ACT 1999

FLEURIEU REGIONAL WASTE AUTHORITY

Notice of Approval of a Regional Subsidiary

THE ALEXANDRINA COUNCIL, the Kangaroo Island Council, the City of Victor Harbor and the District Council of Yankalilla have applied for approval to establish a regional subsidiary, the Fleurieu Regional Waste Authority, pursuant to section 43 and Schedule 2, Clause 17 of the Local Government Act 1999.

FLEURIEU REGIONAL WASTE AUTHORITY

Charter—October 2009

1. INTRODUCTION

1.1 Name

The name of the subsidiary is the Fleurieu Regional Waste Authority (referred to as ‘the Authority’ in this Charter).

1.2 Definitions

‘the Act’ means the Local Government Act 1999 and includes all regulations made thereunder;

‘Administration Costs’ has the same meaning as in the LGA Accounting Regulations and AAS27 accounting standards;

‘Annual General Meeting’ means an annual general meeting of the Board held pursuant to Clause 3.8;

‘the Authority’ means the Fleurieu Regional Waste Authority;

‘the Board’ means the Board of Management of the Authority set out at Clause 3;

‘Board Member’ includes a Constituent Council Board Member and the Independent Chairperson of the Board appointed pursuant to Clause 3.2.1;

‘Constituent Council’ means those councils identified at Clause 1.4;

‘Business Plan’ means the business plan adopted by the Authority pursuant to Clause 5.2;

‘Constituent Council Board Member’ means a member of the Board appointed pursuant to Clause 3.2.1.1;

‘Date of Withdrawal’ means the date a Constituent Council’s withdrawal from the Authority becomes effective pursuant to Clause 8.2.2;

‘Deputy Board Member’ means a person appointed to act as a deputy to a Constituent Council Board Member pursuant to Clause 3.2.2;

‘Deputy Executive Officer’ means the person appointed pursuant to Clause 6.1.4.4 as Deputy Executive Officer;

‘Executive Officer’ means the person appointed pursuant to Clause 6.1 as the Executive Officer of the Authority;

‘Financial Year’ means 1 July in each year to 30 June in the subsequent year;

‘Independent Chairperson of the Board’ or ‘Chairperson’ means the member of the Board appointed pursuant to Clause 3.2.1.2;

‘Long Term Financial Plan’ means the long term financial plan prepared by the Authority and approved by the Constituent Councils pursuant to Clause 4.5.1;

‘Minister’ means the Minister for State/Local Government Relations;

‘Net Assets’ means total assets (current and non-current) less total liabilities (current and non-current) of the Authority as reported in the annual audited financial statements of the Authority;

‘Operating Costs’ means expenses incurred in the delivery of the Authority’s services excluding Administration Costs;

‘Region’ means the collective areas of the Constituent Councils;

‘Strategic Plan’ means the strategic plan adopted by the Authority pursuant to Clause 5.1;

‘Treasury Policy’ means the treasury policy prepared by the Authority and approved by the Constituent Councils pursuant to Clause 4.5.2;

‘Waste’ has the same definition as in the Environment Protection Act 1993.

1.3 Interpretation

In this Charter, unless the context otherwise requires:

1.3.1 headings do not affect interpretation;

1.3.2 singular includes plural and plural includes singular;

1.3.3 words of one gender include any gender;

1.3.4 a reference to a person includes a partnership, corporation, association, government body and any other entity;

1.3.5 a reference to legislation includes any amendment to it, any legislation substituted for it, and any subordinate legislation made under it;

1.3.6 an unenforceable provision or part of a provision may be severed, and the remainder of this Charter continues in force, unless this would materially change the intended effect of this Charter;

1.3.7 the meaning of general words is not limited by specific examples introduced by ‘including’, ‘for example’ or similar expressions; and

1.3.8 a reference to a ‘Clause’ means a clause of this Charter.

1.4 Establishment

The Authority is a regional subsidiary established under Section 43 of the Act by the:

1.4.1 City of Victor Harbor;

1.4.2 Alexandrina Council;

1.4.3 Kangaroo Island Council; and

1.4.4 Yankalilla District Council.

1.5 Local Government Act 1999

This Charter must be read in conjunction with Parts 2 and 3 of Schedule 2 of the Act. The Authority shall conduct its affairs in accordance with Parts 2 and 3 of Schedule 2 to the Act except as modified by this Charter in a manner permitted by the Act.

1.6 National Competition Policy

The Authority does not undertake any commercial activities which constitute a significant business activity of the Authority to which the principles of competitive neutrality must be applied.

1.7 Objects and Purposes

1.7.1 The Authority is established for the following objects and purposes:

1.7.1.1 to educate, engage and motivate the Constituent Councils’ communities to achieve the practical reduction of Waste through reuse and recycling initiatives;

1.7.1.2 to facilitate and co-ordinate the management of Waste on behalf of the Constituent Councils including collection, treatment, disposal and recycling within the Region;

1.7.1.3 to facilitate and coordinate the management of Waste outside the Region for which the Authority is or may become responsible including the collection, treatment, disposal and recycling of Waste;

- 1.7.1.4 to develop and implement policies designed to improve the management of Waste and recycling programmes and practices within the Region;
 - 1.7.1.5 to regularly review the Region's management of Waste and recycling practices and policies;
 - 1.7.1.6 to provide and operate a place or places in the Region or outside the Region for the treatment, recycling and disposal of Waste collected by the Authority, including operating transfer stations;
 - 1.7.1.7 to develop further co-operation between the Constituent Councils in the collection, treatment, recycling and disposal of Waste for which the Constituent Councils are or may become responsible;
 - 1.7.1.8 to minimise the volume of Waste collected in the areas of the Constituent Councils which is required to be disposed of by landfill;
 - 1.7.1.9 to provide a forum for discussion and/or research for the ongoing improvement of the management of Waste.
- 1.7.2 The Authority must in the performance of its objects and purposes and in all of its plans, policies, and activities give due weight to economic, social and environmental considerations.

1.8 Powers

- 1.8.1 The powers, functions and duties of the Authority are to be exercised in the performance and furtherance of the Authority's objects and purposes. The Authority has the following powers, functions and duties:
- 1.8.1.1 subject to Clauses 1.9 and 1.10 to purchase, sell, lease, hire, rent or otherwise acquire or dispose of any real property or interests therein in or outside the Region;
 - 1.8.1.2 subject to Clause 1.9 to institute, initiate and carry on legal proceedings provided that any litigation is subject to an immediate urgent report to the Constituent Councils by the Executive Officer;
 - 1.8.1.3 subject to Clause 1.9 to enter into any kind of contract or arrangement;
 - 1.8.1.4 to borrow funds and incur expenditure in accordance with Clause 1.9;
 - 1.8.1.5 to enter into agreements with the Constituent Councils or any other person, body or council for the purpose of the collection, treatment, recycling and disposal of Waste and operating and managing transfer stations and other sites in and outside the Region for the treatment, recycling and disposal of Waste;
 - 1.8.1.6 to raise finance for all purposes relating to the collection, treatment, recycling and disposal of Waste;
 - 1.8.1.7 to determine the types of refuse and Waste which will be collected or received and the method of collection, treatment, recycling and disposal of the Waste;
 - 1.8.1.8 to adopt and use a trading name provided that the Authority must first register the trading name with the Office of Consumer and Business Affairs in accordance with the Business Names Act 1996;
 - 1.8.1.9 subject to Clause 1.9 to agree to undertake a project in conjunction with any council or government agency or authority and in doing so to participate in the formation of a trust, partnership or joint venture with any council or government agency or authority to give effect to the project;
 - 1.8.1.10 to employ, engage, determine conditions of employment/engagement, remunerate, remove, suspend or dismiss/terminate the Executive Officer of the Authority;
 - 1.8.1.11 to open and operate bank accounts;
 - 1.8.1.12 to make submissions for and accept grants, subsidies and contributions to further its objects and purposes;

- 1.8.1.13 to charge whatever fees the Authority considers appropriate for services rendered to any person, body or council (other than a Constituent Council) provided that such fees charged by the Authority shall be sufficient to at least cover the cost to the Authority of providing the services;
 - 1.8.1.14 to charge the Constituent Councils fees for services that (as a minimum) cover the cost to the Authority of providing the services;
 - 1.8.1.15 to accumulate surplus funds for investment purposes;
 - 1.8.1.16 to distribute all or any surplus funds and/or to make payment of a dividend to the Constituent Councils provided that such distribution or payment will be made to the Constituent Councils in the proportions of their equitable interest in the Authority as set out at Clause 8.4;
 - 1.8.1.17 to invest any funds of the Authority in any investment authorised by the Trustee Act 1936 or with the Local Government Finance Authority provided that:
 - (a) in exercising this power of investment the Authority must exercise the care, diligence and skill that a prudent person of business would exercise in managing the affairs of other persons; and
 - (b) the Authority must avoid investments that are speculative or hazardous in nature;
 - 1.8.1.18 to employ, engage or retain professional advisers to the Authority;
 - 1.8.1.19 to establish a reserve fund(s) clearly identified for the upkeep and/or replacement of fixed assets of the Authority or meeting any deferred liability of the Authority;
 - 1.8.1.20 to act outside the areas of the Constituent Councils for the purpose of collecting, treating, recycling and disposing of Waste including operating and managing transfer stations and other sites for the treatment, recycling and disposal of Waste;
 - 1.8.1.21 to do anything else necessary or convenient for, or incidental to, the exercise, performance or discharge of its powers, functions or duties;
 - 1.8.1.22 to undertake all manner of things relating and incidental to the collection, treatment, recycling and disposal of Waste;
 - 1.8.1.23 such other powers, functions and duties as are delegated to the Authority by the Constituent Councils from time to time.
- 1.8.2 Notwithstanding any other clause or provision in this Charter, the Authority may not act outside the areas of the Constituent Councils unless the Constituent Councils have, prior to the Authority so acting, granted approval to the Authority to act outside the area of the Constituent Councils on the basis that the Constituent Councils consider it necessary or expedient to the performance of the Constituent Councils' or Authority's functions.

1.9 Borrowings and Expenditure

- 1.9.1 The Authority has the power to incur expenditure as follows:
- 1.9.1.1 in accordance with a budget adopted by the Authority and approved by the Constituent Councils as required by the Act or this Charter; or
 - 1.9.1.2 with the prior approval of all of the Constituent Councils; or
 - 1.9.1.3 in accordance with the Act, and in respect of expenditure not contained in budget adopted by the Authority and approved by the Constituent Councils as required by the Act and this Charter, for a purpose of genuine emergency or hardship.
- 1.9.2 Subject to Clause 1.9.3 the Authority has the power to borrow money as follows:
- 1.9.2.1 in accordance with a budget adopted by the Authority and approved by the Constituent Councils as required by the Act or this Charter; or

- 1.9.2.2 in respect of borrowings not contained in a budget adopted by the Authority and approved by the Constituent Councils as required by the Act and this Charter, up to a maximum amount not exceeding the net financial ratio stated in the Authority's Long Term Financial Plan and supported within the Authority's Treasury Policy; or
- 1.9.2.3 with the prior approval of all of the Constituent Councils.
- 1.9.3 Unless otherwise approved by all of the Constituent Councils, all borrowings taken out by the Authority:
 - 1.9.3.1 must not be used for the purpose of funding operational costs;
 - 1.9.3.2 must be from the Local Government Financial Authority or a registered bank or financial institution within Australia; and
 - 1.9.3.3 must be drawn down within a period of 24 months from the date of approval.

1.10 Property

- 1.10.1 All property held by the Authority is held by it on behalf of the Constituent Councils.
- 1.10.2 No person may sell, encumber or otherwise deal with any property of the Authority without the approval of the Board by way of and evidenced by a resolution of the Board.

1.11 Delegation by the Authority

- 1.11.1 The Authority may, in accordance with this Charter and the Act, by resolution, delegate to any officer of the Authority any of its powers, functions and duties under this Charter but may not delegate:
 - 1.11.1.1 the power to impose charges;
 - 1.11.1.2 the power to enter into transactions on behalf of the Authority in excess of \$100,000;
 - 1.11.1.3 the power to borrow money or obtain any other forms of financial accommodation;
 - 1.11.1.4 the power to approve expenditure of money on the works, services or operations of the Authority not set out in a budget adopted by the Authority and approved by the Constituent Councils in accordance with the Act and this Charter;
 - 1.11.1.5 the power to approve the reimbursement of expenses or payment of allowances to members of the Board;
 - 1.11.1.6 the power to adopt budgets;
 - 1.11.1.7 the power to adopt or revise financial estimates and reports; and
 - 1.11.1.8 the power to make any application or recommendation to the Minister.
- 1.11.2 A delegation is revocable at will and does not prevent the Authority from acting in a matter.

2. STRUCTURE

- 2.1 The Authority is a body corporate and is governed by the Act and this Charter. The Board is the Authority's governing body and has the responsibility for the administration of the affairs of the Authority ensuring that the Authority acts in accordance with this Charter and all relevant legislation including the Act.
- 2.2 All meetings of the Authority shall be meetings of the Board.
- 2.3 The Authority will be entitled to make decisions in accordance with the powers and functions of the Authority specified in this Charter.

3. THE BOARD OF MANAGEMENT

The Board is responsible for managing all of the activities and affairs of the Authority and ensuring that the Authority acts in accordance with this Charter and all relevant legislation including the Act.

3.1 Functions of the Board

- 3.1.1 In addition to the functions of the Board set out in the Act, the functions of the Board include:
- 3.1.1.1 the formulation of strategic and business plans in accordance with Clause 5 and the development of strategies aimed at improving the business of the Authority;
 - 3.1.1.2 to provide professional input and policy direction to the Authority;
 - 3.1.1.3 monitoring, overseeing and measuring the performance of the Executive Officer of the Authority;
 - 3.1.1.4 ensuring that ethical behaviour and integrity is established and maintained by the Authority, the Board and the Board Members in all activities undertaken by the Authority;
 - 3.1.1.5 exercising the care, diligence and skill that a prudent person of business would exercise in managing the affairs of other persons;
 - 3.1.1.6 developing and giving effect to policies that reflect the Authority's responsibilities under the National Competition Policy (if applicable) and the Trade Practices Act (Cth) 1974;
 - 3.1.1.7 ensuring that the Authority operates in accordance with this Charter and all relevant legislation.

3.2 Membership

- 3.2.1 The Board shall consist of nine Board Members appointed as follows:
- 3.2.1.1 Constituent Council Board Members
 - (a) Each Constituent Council shall appoint on such conditions as the Constituent Council may determine one (1) elected member of the Constituent Council to be a Board Member and may at any time terminate or revoke that appointment and appoint another elected member of the Constituent Council to be a Board Member;
 - (b) Each Constituent Council shall appoint on such conditions as the Constituent Council may determine one (1) staff member of the Constituent Council to be a Board Member and may at any time terminate or revoke that appointment and appoint another staff member of the Constituent Council to be a Board Member;
 - 3.2.1.2 Independent Chairperson of the Board
 - (a) The Constituent Councils shall jointly and unanimously appoint on such conditions as the Constituent Councils may determine one (1) person with relevant professional expertise who is neither an elected member nor officer of any of the Constituent Councils to be the Chairperson of the Board;
 - (b) the Independent Chairperson of the Board shall be selected from a list of persons provided to the Constituent Councils with such list being determined by a panel comprising the Mayors and Chief Executive Officers of the Constituent Councils;
 - (c) the Constituent Councils may, at any time by a joint resolution of all of the Constituent Councils, terminate or revoke the appointment of the Independent Chairperson of the Board and appoint another person to be the Independent Chairperson of the Board.
 - 3.2.2 Each Constituent Council will appoint an elected member of the Constituent Council and a staff member of the Constituent Council to be Deputy Board Members who may act in place of the Constituent Council's Board Members if the respective Board Member for whom the elected member or staff member (as the case may be) is appointed as a deputy Board Member is unable for any reason to be present at a meeting of the Board and may at any time terminate or revoke that appointment and appoint another elected member or officer (as the case may require) of the Constituent Council to be a Deputy Board Member.
 - 3.2.3 In the absence of a Board Member, the Deputy Board Member of that Board Member will be deemed to be the Board Member and may exercise all rights, privileges and obligations of that Board Member during the absence of that Board Member.

3.2.4 Each Constituent Council must give notice in writing to the Authority of its appointment of Board Members and Deputy Board Members, the term of appointment if applicable and of any termination or revocation of those appointments. A notice in writing signed by the Chief Executive Officer of the Constituent Council will be sufficient evidence of an appointment, termination or revocation of an appointment and will constitute notice as required by this Clause 3.2.4.

3.2.5 The Independent Chairperson will be eligible for an allowance from the funds of the Authority as determined by the Constituent Councils.

3.3 Term of Office

3.3.1 Subject to Clause 3.3.3 the term of office of a Constituent Council Board Member and Deputy Board Member, shall be for a term determined by the Constituent Council appointing that Board Member. At the conclusion of a Constituent Council Board Member's term of office such Board Member will be eligible for re-appointment.

3.3.2 Subject to Clause 3.3.3, the term of office of the Independent Chairperson of the Board shall be for a period of two (2) years. At the conclusion of the term of office of the Independent Chairperson of the Board, the Independent Chairperson of the Board will be eligible for re-appointment.

3.3.3 The office of a Board Member, including where applicable the office of Independent Chairperson of the Board, will become vacant:

3.3.3.1 if any of the grounds or circumstances set out in the Act as to when a Board Member's office becomes vacant arises; or

3.3.3.2 in relation to a Constituent Council Board Member, upon:

(a) the Constituent Council who appointed the Board Member terminating or revoking the Board Member's appointment;

(b) the Constituent Council who appointed the Board Member ceasing to be a Constituent Council;

(c) the Board Member ceasing to be an elected member of the Constituent Council that appointed him or her;

(d) the Board Member ceasing to be a staff member of the Constituent Council that appointed him or her; or

(e) the conclusion of the next periodic local government election following their appointment;

3.3.3.3 in relation to the Independent Chairperson of the Board upon the Constituent Councils jointly and unanimously terminating or revoking Independent Chairperson of the Board's appointment;

3.3.3.4 upon the happening of any other event through which the Board Member would be ineligible to remain as a Board Member.

3.3.4 The office of a Deputy Board Member will become vacant in the same way as the office of a Board Member will become vacant as set out in Clause 3.3.3.

3.3.5 The Board may by a majority vote of the Board Members present (excluding the Board Member subject to this Clause) make a recommendation to a Constituent Council that it terminate the appointment of a Constituent Council Board Member appointed by that Constituent Council or the Independent Chairperson of the Board in the event of any behaviour of that Board Member which in the opinion of the Board amounts to:

3.3.5.1 impropriety;

3.3.5.2 serious neglect of duty in attending to the responsibilities as a Board Member;

3.3.5.3 breach of fiduciary duty to the Board or a Constituent Council;

3.3.5.4 breach of any of the legislative obligations and duties of a Board Member including the conflict of interest provisions in the Act;

3.3.5.5 breach of the duty of confidentiality to the Board and/or the Constituent Councils; or

- 3.3.5.6 any other behaviour which may discredit the Board, the Authority or the Constituent Councils.
- 3.3.6 Where, for any reason, the office of a Constituent Council Board Member becomes vacant the Constituent Council which appointed the Board Member will be responsible for appointing a replacement Board Member and in the case of the Independent Chairperson of the Board the Constituent Councils will jointly be responsible for appointing a replacement Board Member.
- 3.3.7 If any vacancy occurs in the membership of the Board it must be filled in the same manner as the original appointment under Clause 3.2.1. The person appointed to fill the vacancy will be appointed for the balance of the term of the original appointment and at the expiry of that term shall be eligible for reappointment.

3.4 Independent Chairperson of the Board

The Independent Chairperson of the Board shall preside at all meetings of the Board and in the event of the Chairperson being absent from a meeting the Board shall appoint a Board Member present to be the Chairperson for that meeting.

3.5 Proceedings of the Board

- 3.5.1 The provisions of Part 2 of the Local Government (Procedures at Meetings) Regulations 2000 shall, insofar as the same may be applicable and not inconsistent with this Charter, apply to proceedings at and conduct of meetings of the Board.
- 3.5.2 Ordinary meetings of the Board will be held at such times and places as determined by the Board except for the first ordinary meeting of the Board following the establishment of the Authority which shall be determined by the Executive Officer of the Authority. There must be at least one ordinary meeting of the Board every four months.
- 3.5.3 An ordinary meeting of the Board will constitute an ordinary meeting of the Authority. The Board shall administer the business of the Authority at the ordinary meeting.
- 3.5.4 For the purposes of this Clause 3.5, the contemporary linking together by telephone, audio-visual or other instantaneous means ('telecommunications meeting') of the Board Members provided that at least a quorum is present, is deemed to constitute a meeting of the Board. Each of the Board Members taking part in the telecommunications meeting, must at all times during the telecommunications meeting be able to hear and be heard by each of the other Board Members present. At the commencement of the meeting, each Board Member must announce his/her presence to all other Board Members taking part in the meeting. A Board Member must not leave a telecommunications meeting by disconnecting his/her telephone, audio-visual or other communication equipment, unless that Board Member has previously notified the Chairperson of the meeting.
- 3.5.5 A proposed resolution in writing and given to all Board Members in accordance with proceedings determined by the Board will be a valid decision of the Board where a majority of Board Members vote in favour of the resolution by signing and returning the resolution to the Executive Officer or otherwise giving written notice of their consent and setting out the terms of the resolution to the Executive Officer. The resolution shall thereupon be as valid and effectual as if it had been passed at a meeting of the Board duly convened and held.
- 3.5.6 Any Constituent Council, the Chairperson or three (3) Board Members may by delivering a written request to the Executive Officer require a special meeting of the Board to be held. The written request must be accompanied by the agenda for the special meeting and if an agenda is not provided the request has no effect.
- 3.5.7 On receipt of a written request pursuant to Clause 3.5.6, the Executive Officer must send a notice to all Board Members at least four (4) hours prior to the commencement of the special meeting.
- 3.5.8 Subject to Clause 3.5.9, notice of an ordinary meeting of the Board will be given by the Executive Officer to each Board Member not less than three (3) clear days prior to the holding of the meeting.
- 3.5.9 The Executive Officer must, in relation to a notice of meeting of the Board for the purpose of considering the making of a recommendation to the Constituent Councils to wind up the Authority, provide the notice to all Board Members at least four (4) months before the date of the meeting.

- 3.5.10 Notice of meeting of the Board must:
- 3.5.10.1 be in writing;
 - 3.5.10.2 set out the date, time and place of the meeting;
 - 3.5.10.3 be signed by the Executive Officer; and
 - 3.5.10.4 contain, or be accompanied by, the agenda for the meeting.
- 3.5.11 The Executive Officer must, insofar as is reasonably practicable:
- 3.5.11.1 ensure that items on an agenda given to Board Members are described with reasonable particularity and accuracy; and
 - 3.5.11.2 supply to each Board Member at the time that notice of a meeting is given a copy of any documents or reports that are to be considered at the meeting (so far as this is practicable).
- 3.5.12 Notice of a meeting of the Board may be given to a Board Member:
- 3.5.12.1 personally;
 - 3.5.12.2 by delivering the notice (whether by post or otherwise) to the usual place of residence of the Board Member or to another place authorised in writing by the Board Member;
 - 3.5.12.3 in the case of a Constituent Council Board Member by leaving the notice for the Board Member at an appropriate place at the principal office of the Constituent Council which appointed the Board Member; or
 - 3.5.12.4 by a means authorised in writing by the Board Member as being an available means of giving notice.
- 3.5.13 A notice that is not given in accordance with Clause 3.5.12 is taken to have been validly given if the Executive Officer considers it impracticable to give the notice in accordance with that Clause and takes action the Executive Officer considers reasonably practicable in the circumstances to bring the notice to the attention of the Board Member.
- 3.5.14 The Executive Officer must maintain a record of all notices of Board meetings given under Clause 3.5.10 to Board Members.
- 3.5.15 Subject only to the special provisions of this Clause, a meeting of the Board must not commence until a quorum of Board Members is present and a meeting must not continue if there is not a quorum of Board Members present. A quorum of Board Members will comprise one half of the Board Members in office, ignoring any fraction, plus one.
- 3.5.16 Meetings of the Board must be open to the public unless the Board resolves to consider a matter in confidence in accordance with the provisions of Chapter 6, Part 3 of the Act in which case the provisions of Chapter 6 Part 3 of the Act will apply as though the Authority were a council. Where an order is made under this Clause 3.5.16, a note must be made in the minutes of the meeting of the making of the order and of the grounds on which it was made.
- 3.5.17 Where the Board has considered any information or matter in confidence under Clause 3.5.16 it may subsequently resolve to keep the minutes and/or documents considered during that part of the meeting confidential in accordance with Section 91 of the Act.
- 3.5.18 All matters for decision at a meeting of the Board will be decided by a simple majority of the Board Members present and entitled to vote on the matter. All Board Members including the Chairperson present and entitled to vote on a matter are required to vote. All Board Members including the Chairperson are entitled to a deliberative vote and if the votes are equal the Chairperson or other Board Member presiding at the meeting does not have a second or casting vote.
- 3.5.19 All Board Members must at all times keep confidential all documents and any information provided to them for their consideration prior to a meeting of the Board.

3.5.20 The Executive Officer must cause minutes to be kept of the proceedings at every meeting of the Board and ensure that the minutes are presented to the next ordinary meeting of the Board for confirmation and adoption. Where the Executive Officer is absent or excluded from attendance at a meeting of the Board pursuant to Clause 3.5.16, the person presiding at the meeting shall cause the minutes to be kept.

3.5.21 The Executive Officer must, within five (5) days after a meeting of the Board provide to each Board Member a copy of the minutes of the meeting of the Board.

3.6 Propriety of Members of the Board

3.6.1 All provisions governing the propriety and duties of elected members of a council and public officers under the Act and other South Australian legislation apply to Board Members.

3.6.2 Board Members will not be required to submit returns under Chapter 5, Part 4, Division 2 of the Act.

3.6.3 The provisions regarding conflict of interest prescribed in the Act apply to all Board Members as if they were elected members of a council and the Authority were a council.

3.6.4 A Board Member must at all times act in accordance with their duties of confidence and confidentiality and individual fiduciary duties, including honesty and the exercise of reasonable care and diligence with respect to the performance and discharge of official functions and duties as required by Part 4, Division 1, Chapter 5 of the Act and Clause 23 of Schedule 2, Part 2 of the Act.

3.7 Committees

3.7.1 The Authority may from time to time as it sees fit establish committees for the purposes of assisting it in the performance of its functions. A committee established by the Authority under this provision may be comprised of such persons that the Authority determines.

3.7.2 The Authority will determine the procedure, terms of reference, reporting requirements and other matters applicable to a committee at the time of establishing the committee.

3.8 Annual General Meeting

3.8.1 An Annual General Meeting of the Board must be held prior to 30 June in each year at a place and time determined by a resolution of the Board.

3.8.2 The business to be conducted at the Annual General Meeting shall be of a general nature aimed at reviewing the progress and direction of the Authority and shall include the following:

3.8.2.1 Chairperson's report;

3.8.2.2 adoption of the annual budget for the ensuing financial year;

3.8.2.3 receiving the audited financial statements for the preceding financial year;

3.8.2.4 consideration of any other matters or business as determined by the Board.

4. BUDGETS AND CONTRIBUTIONS

4.1 Annual Budget

4.1.1 The Authority must by 30 April of each year prepare and submit to the Constituent Councils a draft annual budget for the ensuing financial year in accordance with the Act and the Local Government (Financial Management) Regulations 1999 for approval by the Constituent Councils.

4.1.2 The Authority must adopt after 31 May and before 30 June of each year an annual budget in accordance with the Act and the Local Government (Financial Management) Regulations 1999 for the ensuing financial year as approved by the Constituent Councils pursuant to Clause 4.1.1.

4.1.3 The Authority must provide a copy of its annual budget to each Constituent Council within five (5) business days after the annual budget is adopted by the Authority.

4.1.4 The Authority must reconsider its annual budget at least three times at intervals of not less than three months between 30 September and 31 May (inclusive) in the relevant financial year and may with the unanimous approval of the Constituent Councils amend its annual budget for a financial year at any time before the year ends.

(See Clause 25, Part 2, Schedule 2 to the Act for the contents of the budget)

4.1.5 Reports summarising the financial position and performance of the Authority against the annual budget shall be prepared and presented to the Board at each ordinary meeting of the Board and copies provided to the Chief Executive Officer of each Constituent Council.

4.2 Financial Contributions

The Authority will determine annually and will include within the annual budget provided to the Constituent Councils the funds required by the Authority to enable the Authority to operate and to fulfil its objects and purposes.

4.3 Administration Contributions

4.3.1 The Authority will determine annually and will include within the budget provided to the Constituent Councils for approval the administrative funds required by the Authority to enable it to function ('Administration Costs').

4.3.2 Each of the Constituent Councils will contribute monies equally to the Administration Costs required by the Authority as set out in the adopted budget of the Authority.

4.3.3 The Administration Costs will be paid by each Constituent Council in advance by monthly instalments.

4.3.4 The Authority may during any Financial Year for purposes of genuine emergency or hardship determine that additional contributions to the Administration Costs are required for the continuing function of the Authority.

4.3.5 Any additional contributions to the Administration Costs will be paid in equal proportions by each Constituent Council in the manner and at the time determined by the Board.

4.4 Operating Contributions

4.4.1 The Authority may fix fees, charges, imposts or levies payable for services provided by the Authority, including the collection, treatment, disposal and recycling of waste.

4.4.2 The Board will determine annually and include in the adopted budget the Operating Costs. The Constituent Councils shall contribute monies towards the Operating Costs on a 'user pays' basis as agreed between the Authority and the Constituent Councils as part of the annual budget process. The Authority will adopt appropriate procedures and policies to ensure transparency and fairness among the Constituent Councils in the setting of fees, charges, imposts or levies payable for services provided by the Authority.

4.4.3 The Board may during any year for purposes of genuine emergency or hardship determine that additional contributions to the Operating Costs are required for the continuing function of the Authority. The Constituent Councils shall contribute additional monies to the additional Operating Costs in such amounts as may reasonably be determined by the Authority.

4.4.4 Any contribution to Operating Costs shall be made by each Constituent Council within 60 days of notice in writing being given by the Authority to the Chief Executive Officer of the Constituent Council, provided that if the Board so decides such payments must be made in advance by monthly instalments.

4.5 Long Term Financial Plan and Treasury Policy

4.5.1 The Authority must prepare and submit to the Constituent Councils for their approval a Long Term Financial Plan covering a period of at least ten (10) years.

4.5.2 The Authority must prepare and submit to the Constituent Councils for their approval a Treasury Policy.

5. MANAGEMENT

5.1 Strategic Plans

The Authority must:

- 5.1.1 subject to Clause 5.1.3 prepare and adopt a Strategic Plan covering a ten (10) year period for the conduct of its business which will identify its objectives over the period of the Strategic Plan and the principal activities that the Authority intends to undertake to achieve its objectives;
- 5.1.2 in consultation with the Constituent Councils, review the Strategic Plan at any time but must undertake a comprehensive review at least once every four years; and
- 5.1.3 submit the Strategic Plan to the Constituent Councils for their approval.

5.2 Business Plans

The Authority must:

- 5.2.1 subject to Clause 5.2.3 prepare and adopt a Business Plan covering the period of three (3) years in accordance with the Act linking the core business activities of the Authority to strategic, operational and organisational requirements with supporting financial projections setting out the estimates of revenue and expenditure as necessary for the period of the Business Plan;
- 5.2.2 in consultation with the Constituent Councils review the Business Plan annually; and
- 5.2.3 submit the Business Plan to the Constituent Councils for their unanimous approval prior to being adopted by the Authority.

(See Clause 24, Part 6, Schedule 2 to the Act for the contents of the Business Plan)

5.3 Reporting

- 5.3.1 The Authority must submit to the Constituent Councils, by 30 September in each year a report on the work and operations of the Authority for the preceding financial year detailing achievement of the aims and objectives of its Business Plan and incorporating the audited financial statements of the Authority for the relevant financial year and any other information or reports as required by the Constituent Councils or prescribed by the Act.

6. ADMINISTRATIVE MATTERS

6.1 Executive Officer and Staff

- 6.1.1 The Authority must appoint an Executive Officer on such terms and conditions as determined by the Board. The Executive Officer will be appointed in accordance with Section 98 of the Act as though the Authority were a council and the Executive Officer a Chief Executive Officer of a council.
- 6.1.2 The Executive Officer is responsible for the implementation of decisions of the Authority in a timely and efficient manner and for the efficient and effective management of the affairs of the Authority.
- 6.1.3 The Authority shall delegate responsibility for the day-to-day management of the Authority to the Executive Officer, who will ensure that sound business and human resource management practices are applied in the efficient and effective management of the operations of the Authority.
- 6.1.4 The functions of the Executive Officer will be specified in the terms and conditions of employment and will include but are not limited to:
 - 6.1.4.1 carrying out such duties as the Board may direct;
 - 6.1.4.2 attending at all meetings of the Board unless excluded by resolution of the Board;
 - 6.1.4.3 providing information to assist the Board to assess the Authority's performance against its Strategic and Business Plans;
 - 6.1.4.4 appointing, managing, suspending and dismissing all other employees of the Authority including with the concurrence of the Board, a Deputy Executive Officer;
 - 6.1.4.5 determining the conditions of employment of all other employees of the Authority, within budgetary constraints set by the Board;

- 6.1.4.6 providing advice and reports to the Board on the exercise and performance of its powers and functions under this Charter or any Act;
 - 6.1.4.7 ensuring that the assets and resources of the Authority are properly managed and maintained;
 - 6.1.4.8 ensuring that records required under the Act or any other legislation are properly kept and maintained;
 - 6.1.4.9 exercising, performing or discharging other powers, functions or duties conferred on the Executive Officer by or under the Act or any other legislation or this Charter, and performing other functions lawfully directed by the Board;
 - 6.1.4.10 achieving financial and other outcomes in accordance with adopted plans and budgets of the Authority; and
 - 6.1.4.11 efficiently and effectively managing the operations and affairs of the Authority.
- 6.1.5 The Executive Officer shall comply with Section 107 of the Act as though the Authority were a council and the Executive Officer were a Chief Executive Officer of a council.
- 6.1.6 In the absence of the Executive Officer for any period exceeding three weeks the Deputy Executive Officer will act in the office of the Executive Officer and in the absence of the Executive Officer and Deputy Executive Officer, the Executive Officer may after consultation with the Authority appoint a suitable person to act in the position of Executive Officer for the period of absence of the Executive Officer or Deputy Executive Officer.
- 6.1.7 The Executive Officer may delegate or sub-delegate to an employee of the Authority or a committee comprising employees of the Authority, any power or function vested in or delegated to the Executive Officer. Such delegation or sub-delegation may be subject to any conditions or limitations as determined by the Executive Officer.
- 6.1.8 Where a power or function is delegated to an employee, the employee is responsible to the Executive Officer for the efficient and effective exercise or performance of that power or function.
- 6.1.9 A written record of all delegations and sub-delegations must be kept by the Executive Officer at all times.

6.2 Auditor and Other Professionals

- 6.2.1 The Authority must annually appoint an Auditor in accordance with the Local Government (Financial Management) Regulations 1999 on such terms and conditions as determined by the Authority.
- 6.2.2 The audit of financial statements together with the accompanying report from the Auditor shall be submitted to both the Board and the Constituent Councils.
- 6.2.3 The Authority may engage professional consultants and it may authorise the Executive Officer to so engage professional consultants to provide services to the Authority to ensure the proper execution of its decisions, the efficient and effective management of the operations and affairs of the Authority, and for giving effect to the general management objectives and principles of personnel management prescribed by the Charter.
- 6.2.4 The Authority is exempt from establishing an audit committee as required by Clause 30, Schedule 2 of the Act.

6.3 Common Seal

- 6.3.1 The Authority shall have a common seal which may be affixed to documents and must be attested by the signatures of two Board Members.
- 6.3.2 The common seal must not be affixed to a document except in pursuance of a decision of the Board. The Executive Officer will maintain a register which records the resolutions of the Board giving authority to affix the common seal and details of the documents to which the common seal has been affixed with the particulars of the persons who attested the fixing of the seal and the date thereof.

7. FINANCE

7.1 Financial Management

- 7.1.1 The Authority shall keep proper books of accounts in accordance with the requirements of the Local Government (Financial Management) Regulations 1999.
- 7.1.2 The Authority's books of accounts must be available for inspection by any Board Member or authorised representative of any Constituent Council at any reasonable time.

7.2 Banking

- 7.2.1 The Authority must establish and maintain a bank account(s) with such banking facilities and at a bank to be determined by the Board.
- 7.2.2 The Executive Officer must act prudently in the handling of all financial transactions for the Authority and must provide quarterly financial and corporate reports to the Board and the Constituent Councils.

8. MISCELLANEOUS MATTERS

8.1 Alteration to Charter

- 8.1.1 Subject to the Act, a Constituent Council, a Board Member, or the Executive Officer may by the giving of not less than two month's notice of the proposed changes to all Constituent Councils and the Board request that this Charter be amended.
- 8.1.2 Before the Constituent Councils vote on a proposal to amend the Charter they must take into account any recommendations of the Board.
- 8.1.3 This Charter may only be amended with the unanimous agreement of the Constituent Councils expressed by resolution.

8.2 Withdrawal of a Constituent Council

- 8.2.1 A Constituent Council may with the Minister's consent withdraw from the Authority by giving not less than six months written notice of its intention to do so, subject to Clause 8.2.2, to the Board and to the other Constituent Councils.
- 8.2.2 In any event, a withdrawal will not become effective until 30 June following the expiry of the six months written notice period referred to in Clause 8.2.1. Until a withdrawal becomes effective the Constituent Council proposing withdrawal from the Authority will remain liable for all financial contributions up to the Date of Withdrawal, and through its Board Members and Deputy Board Members retains responsibility for ensuring the continued proper conduct of the affairs of the Authority during that time.
- 8.2.3 Upon withdrawal taking effect and subject to Clause 8.2.4 a Constituent Council will be entitled at the discretion of the Board to be paid not more than 80% of the Constituent Council's equity interest in the Net Assets of the Authority as at the Date of Withdrawal. The withdrawing Constituent Council will be entitled to receive that sum by quarterly instalments to be paid over a period of two years with the first instalment being due on the 1st day of January following the Date of Withdrawal.
- 8.2.4 A Constituent Council withdrawing from the Authority will not be entitled to be paid any amount in respect of any reserve fund established under Clause 1.8.1.19.
- 8.2.5 The withdrawal of any Constituent Council does not extinguish the liability of that Constituent Council for the payment of its contribution towards any actual or contingent deficiency in the Net Assets of the Authority at the end of the Financial Year in which such withdrawal occurs.
- 8.2.6 The withdrawal of any Constituent Council does not extinguish the liability of that Constituent Council to contribute to any loss or liability incurred by the Authority at any time before or after the Date of Withdrawal in respect of any act or omission by the Authority prior to such date.
- 8.2.7 Any payment to be made by the Withdrawing Council to the Authority pursuant to Clause 8.2.2 must be made within twelve months of the Date of Withdrawal.

8.3 Addition of New Member

Subject to the provisions of the Act and in particular to obtaining the Minister's approval a council may become a constituent council by agreement of all of the Constituent Councils and this Charter may be amended to provide for the admission of a new constituent council(s).

8.4 Equitable Interest

8.4.1 The equitable interest of the Constituent Councils in the Authority is agreed as follows:

- (i) Victor Harbor Council 35%.
- (ii) Alexandrina Council 35%.
- (iii) Kangaroo Island Council 15%.
- (iv) Yankalilla District Council 15%.

8.4.2 The equitable interest of the Constituent Councils in the Authority as set out at in Clause 8.4.1 may be varied by agreement of the Constituent Councils.

8.5 Winding Up

8.5.1 The Authority may be wound up in accordance with the Act.

8.5.2 In the event of there being Net Assets upon dissolution and after realisation of all assets and meeting all liabilities, the Net Assets will be distributed to the Constituent Councils at that time on the basis of their equitable interest in the Authority at the date of dissolution.

8.5.3 In the event of there being any unfunded liabilities of the Authority at the time of a winding up or otherwise the Constituent Councils acting in accordance with their obligations under the Act will be responsible to meet those liabilities on the basis of their equitable interest in the Authority at the date of dissolution.

8.6 Insurance and Superannuation Requirements

8.6.1 The Authority shall register with the Local Government Mutual Liability Scheme and the Local Government Workers Compensation Scheme and comply with the Rules of those Schemes.

8.6.2 The Authority shall advise the Local Government Risk Management Services of its insurance requirements relating to Local Government Special Risks including buildings, structures, vehicles and equipment under the management, care and control of the Authority.

8.6.3 The Authority shall register with the Local Government Superannuation Scheme and comply with the Rules of that Scheme (where applicable).

8.7 Non-Derogation and Direction by Constituent Councils

8.7.1 The establishment of the Authority does not derogate from the power of any of the Constituent Councils to act independently in relation to a matter within the jurisdiction of the Authority.

8.7.2 Provided that the Constituent Councils have all first agreed as to the action to be taken, the Constituent Councils may direct and control the Authority.

8.7.3 For the purpose of Clause 8.7.2, any direction given by the Constituent Councils must be given in writing to the Executive Officer of the Authority.

8.7.4 Where the Authority is required pursuant to the Act or this Charter to obtain the approval of one or more of the Constituent Councils that approval must only be granted and must be evidenced by a resolution of the Constituent Council granting such approval.

8.7.5 Unless otherwise stated in this Charter where the Authority is required to obtain the consent or approval of the Constituent Councils this means the unanimous consent or approval of all of the Constituent Councils.

8.8 Review of Charter

8.8.1 This Charter will be reviewed by the Constituent Councils acting in concurrence at least once in every three years.

8.8.2 This Charter may be amended with the unanimous approval of all of the Constituent Councils.

8.8.3 The Executive Officer must ensure that the amended Charter is published in the Gazette and a copy of the amended Charter provided to the Minister.

8.8.4 Before the Constituent Councils vote on a proposal to alter this Charter they must take into account any recommendation of the Board.

8.9 Disputes Between Constituent Councils

8.9.1 *General*

8.9.1.1 Where a dispute arises between the Constituent Councils which relates to this Charter or the Authority, ('the Dispute') the Constituent Councils will use their best endeavours to resolve the Dispute and to act at all times in good faith.

8.9.1.2 If the Constituent Councils are unable to resolve the Dispute within seven (7) days, any Constituent Council may notify, in writing, the other Constituent Councils of the Dispute giving details of the Dispute ('the Notice').

8.9.1.3 Within seven (7) days of the Notice the Constituent Councils must refer the Dispute to the Chief Executive Officers of the Constituent Councils.

8.9.1.4 The Chief Executive Officers of the Constituent Councils must meet to resolve the Dispute within seven (7) days of the Dispute being referred to them in accordance with Clause 8.9.1.3, or, if the Dispute is not referred to them within 14 days of the Notice and must be sufficiently authorised to resolve the Dispute without detailed reference to any other person.

8.9.2 *Mediation*

8.9.2.1 A Constituent Council is not entitled to initiate arbitration or court proceedings (except proceedings seeking urgent equitable or injunctive relief) in respect of a Dispute unless it has complied with this Clause 8.9.2.

8.9.2.2 If the Constituent Councils or the Chief Executive Officers of the Constituent Councils are unable to resolve the Dispute the Constituent Councils must refer the Dispute for mediation in accordance with the Mediation Rules of the Law Society of South Australia Incorporated, within seven (7) days of a written request by any Constituent Council to the other Constituent Councils that the Dispute be referred for mediation, to:

(a) a mediator agreed by the Constituent Councils; or

(b) if the Constituent Councils are unable to agree on a mediator within five (5) days after the initial period, a mediator nominated by the then President of the Law Society or the President's successor.

8.9.2.3 In the event the Constituent Councils fail to refer the matter for mediation in accordance with Clause 8.9.2.2, one or more Constituent Councils may refer the matter for mediation in accordance with the Mediation Rules of the Law Society of South Australia Incorporated to a mediator nominated by the then President of the Law Society or the President's successor.

8.9.2.4 The role of any mediator is to assist in negotiating a resolution of the dispute. A mediator may not make a decision that is binding on a Constituent Council unless that Constituent Council has so agreed in writing.

8.9.2.5 If mediation does not resolve the Dispute within 28 days of referral of the Dispute for mediation or such longer period agreed unanimously by the Constituent Councils as evidenced by resolutions of each of the Constituent Councils, any Constituent Council may then refer the Dispute to Arbitration in accordance with Clause 8.9.3.

8.9.3 *Arbitration*

8.9.3.1 An arbitrator may be appointed by agreement between the Constituent Councils.

- 8.9.3.2 Failing agreement as to an arbitrator the then Chairperson of the South Australian Chapter of the Institute of Arbitrators or his successor shall nominate an Arbitrator pursuant to these conditions.
- 8.9.3.3 A submission to arbitration shall be deemed to be a submission to arbitration within the meaning of the Commercial Arbitration Act 1985 (South Australia).
- 8.9.3.4 Upon serving a notice of arbitration the Constituent Council serving the notice shall lodge with the arbitrator a deposit by way of security for the cost of the arbitration proceedings.
- 8.9.3.5 Upon each submission to arbitration, the costs of and incidental to the submission and award shall be at the discretion of the arbitrator who may in his or her sole discretion determine the amount of costs, how costs are to be proportioned and by whom they are to be paid.
- 8.9.4 Whenever reasonably possible performance of the obligations of the Constituent Councils pursuant to this Charter shall continue during the mediation or arbitration proceedings and no payment by either Constituent Council shall be withheld on account of the mediation and arbitration proceedings.

8.10 Circumstances Not Provided For

- 8.10.1 If any circumstance arises about which this Charter is silent, incapable of taking effect or being implemented according to its strict provisions, the Chairperson may decide the action to be taken to ensure achievement of the objects and purposes of the Authority and its effective administration.
- 8.10.2 The Board shall report any such decision to the Constituent Councils.
-
-

MEDICAL BOARD OF SOUTH AUSTRALIA

Recognition of New Medical Specialties

NOTICE is hereby given that The Medical Board of South Australia has approved, at its meeting held on 21 January 2010, the recognition of:

- (a) Sport and Exercise Medicine;
- (b) Addiction Medicine;
- (c) Sexual Health Medicine; and

Sport and Exercise Medicine, Addiction Medicine and Sexual Health Medicine as new medical specialties and further the qualifications of Fellowship of the Australasian College of Sports Physicians (FACSP); Fellowship of the Australasian Chapter of Addiction Medicine, Royal Australasian College of Physicians (FACHAM) and the Fellowship of the Australasian Chapter of Sexual Health Medicine, Royal Australasian College of Physicians (FACHSHM) as appropriate for registration on the Specialist Register subject to section 13 (1) (b) of the Medical Practice Act 2004.

J. HOOPER, Registrar

MINING ACT 1971

NOTICE is hereby given in accordance with section 28 (5) of the Mining Act 1971, that the Minister for Mineral Resources Development proposes to grant an Exploration Licence over the undermentioned area:

Applicant: Tasman Resources Limited
 Location: Iron Knob area—Approximately 50 km west-south-west of Port Augusta.
 Pastoral Leases: Wartaka, Corunna, Pandurra and Myall Creek.
 Term: 1 year
 Area in km²: 194
 Ref.: 2009/00362

Plan and co-ordinates can be found on the PIRSA, website: http://www.pir.sa.gov.au/minerals/public_notices or by phoning Mineral Tenements on (08) 8463 3103.

J. MARTIN, Acting Mining Registrar

MINING ACT 1971

NOTICE is hereby given in accordance with section 28 (5) of the Mining Act 1971, that the Minister for Mineral Resources Development proposes to grant an Exploration Licence over the undermentioned area:

Applicant: Southern Gold Limited
 Location: Half-Moon Lake area—Approximately 120 km north-west of Tarcoola.
 Pastoral Leases: Mobella, Port Commonwealth Hill and Mulgathing.
 Term: 1 year
 Area in km²: 517
 Ref.: 2009/00377

Plan and co-ordinates can be found on the PIRSA, website: http://www.pir.sa.gov.au/minerals/public_notices or by phoning Mineral Tenements on (08) 8463 3103.

J. MARTIN, Acting Mining Registrar

MINING ACT 1971

NOTICE is hereby given in accordance with section 28 (5) of the Mining Act 1971, that the Minister for Mineral Resources Development proposes to grant an Exploration Licence over the undermentioned area:

Applicant: Iluka (Eucla Basin) Pty Ltd
 Location: Fig Tree Corner area—Approximately 130 km north-west of Ceduna.
 Pastoral Leases: Chundaria, Watna and Nanbona.
 Term: 1 year

Area in km²: 1 485

Ref.: 2009/00379

Plan and co-ordinates can be found on the PIRSA, website: http://www.pir.sa.gov.au/minerals/public_notices or by phoning Mineral Tenements on (08) 8463 3103.

J. MARTIN, Acting Mining Registrar

MINING ACT 1971

NOTICE is hereby given in accordance with section 28 (5) of the Mining Act 1971, that the Minister for Mineral Resources Development proposes to grant an Exploration Licence over the undermentioned area:

Applicants: Exco Operations (SA) Ltd (60%)
 Exco Resources (SA) Pty Ltd (40%)
 Location: Drew Hill area—Approximately 20 km north of Olary.
 Pastoral Leases: Boolcoomata, Bulloo Creek, Bindarrah and Bimbowrie.
 Term: 1 year
 Area in km²: 343
 Ref.: 2009/00381

Plan and co-ordinates can be found on the PIRSA, website: http://www.pir.sa.gov.au/minerals/public_notices or by phoning Mineral Tenements on (08) 8463 3103.

J. MARTIN, Acting Mining Registrar

MINING ACT 1971

NOTICE is hereby given in accordance with section 28 (5) of the Mining Act 1971, that the Minister for Mineral Resources Development proposes to grant an Exploration Licence over the undermentioned area:

Applicant: Centrex Metals Limited
 Location: Tooligie Hill area—Approximately 110 km north of Port Lincoln.
 Term: 1 year
 Area in km²: 104
 Ref.: 2010/00009

Plan and co-ordinates can be found on the PIRSA, website: http://www.pir.sa.gov.au/minerals/public_notices or by phoning Mineral Tenements on (08) 8463 3103.

J. MARTIN, Acting Mining Registrar

MINING ACT 1971

NOTICE is hereby given in accordance with section 28 (5) of the Mining Act 1971, that the Minister for Mineral Resources Development proposes to grant an Exploration Licence over the undermentioned area:

Applicant: Iluka Resources Limited
 Location: Pureba area—Approximately 70 km north-east of Ceduna.
 Term: 2 years
 Area in km²: 531
 Ref.: 2010/00011

Plan and co-ordinates can be found on the PIRSA, website: http://www.pir.sa.gov.au/minerals/public_notices or by phoning Mineral Tenements on (08) 8463 3103.

J. MARTIN, Acting Mining Registrar

MINING ACT 1971

NOTICE is hereby given in accordance with section 28 (5) of the Mining Act 1971, that the Minister for Mineral Resources Development proposes to grant an Exploration Licence over the undermentioned area:

Applicant: Rio Tinto Exploration Pty Ltd
 Location: Eucla Basin area—Approximately 220 km north-west of Tarcoola.

Term: 2 years
 Area in km²: 922
 Ref.: 2010/00012

Plan and co-ordinates can be found on the PIRSA, website: http://www.pir.sa.gov.au/minerals/public_notices or by phoning Mineral Tenements on (08) 8463 3103.

J. MARTIN, Acting Mining Registrar

MINING ACT 1971

NOTICE is hereby given in accordance with section 28 (5) of the Mining Act 1971, that the Minister for Mineral Resources Development proposes to grant an Exploration Licence over the undermentioned area:

Applicant: Rio Tinto Exploration Pty Ltd
 Location: Paling Range area—Approximately 260 km north-west of Tarcoola.
 Term: 2 years
 Area in km²: 629
 Ref.: 2010/00013

Plan and co-ordinates can be found on the PIRSA, website: http://www.pir.sa.gov.au/minerals/public_notices or by phoning Mineral Tenements on (08) 8463 3103.

J. MARTIN, Acting Mining Registrar

MINING ACT 1971

NOTICE is hereby given in accordance with section 28 (5) of the Mining Act 1971, that the Minister for Mineral Resources Development proposes to grant an Exploration Licence over the undermentioned area:

Applicant: Rio Tinto Exploration Pty Ltd
 Location: Barton Range North area—Approximately 250 km west-south-west of Coober Pedy.
 Term: 2 years
 Area in km²: 950
 Ref.: 2010/00014

Plan and co-ordinates can be found on the PIRSA, website: http://www.pir.sa.gov.au/minerals/public_notices or by phoning Mineral Tenements on (08) 8463 3103.

J. MARTIN, Acting Mining Registrar

NATIONAL PARKS AND WILDLIFE ACT 1972

Appointment of Wardens

PURSUANT to section 20 of the National Parks and Wildlife Act 1972, I, Leanne Burch, Acting Director of National Parks and Wildlife, authorised delegate, hereby appoint each of the following officers of the Department of Primary Industries and Resources, South Australia (PIRSA); Forestry SA (FSA); Royal Society for Prevention of Cruelty to Animals (RSPCA); the Department of Environment and Conservation, Western Australia (DEC); and the Department for Premier and Cabinet, South Australia (DPC), as listed on Schedule 1 below, as Wardens for the whole of the State of South Australia, pursuant to the said Act, for the period commencing on 4 February 2010 and ending on 31 December 2010.

SCHEDULE 1

Card No.	Name of Warden	Organisation
256	Collins, Peter John	DEC
392	Dawson, Rick	DEC
351	Van Loenen, Nalika	RSPCA
366	Jarman, Russell	RSPCA
399	Hobbs, Samantha	RSPCA
400	Lewis, Andrea	RSPCA
400	Mur, Peter	RSPCA
160	Hackett, David John	SA (FSA)
313	Grant, David Scott	PIRSA (Fisheries)
285	Haycock, Penny Cara	PIRSA (Fisheries)
243	Parke, Robin Nicholas	PIRSA (Fisheries)
244	Read, Matthew John	PIRSA (Fisheries)
246	Stanley, Phillip Lawrence	PIRSA (Fisheries)
249	Webb, Scott Raymond	PIRSA (Fisheries)
289	Ferraro, Tania	PIRSA (Fisheries)
316	Heycock, Greg John	PIRSA (Fisheries)
317	Stening, Roger Grant	PIRSA (Fisheries)
318	Stanley, Brooke Nicole	PIRSA (Fisheries)
319	Faithow, Paul	PIRSA (Fisheries)
469	Crow, Heidi	DPC
470	Birt, Peter	DPC
471	Karamanlis, Panagiota	DPC
470	Hancock, Dale	DPC

Dated 29 January 2010.

L. BURCH, Acting Director of National Parks and Wildlife

NATIONAL PARKS AND WILDLIFE ACT 1972

Declaration of Boobook Hill Sanctuary

I, JAY WEATHERILL, Minister for Environment and Conservation for the time being administering the National Parks and Wildlife Act 1972, being of the opinion that it is desirable to conserve the animals and plants for which the land depicted as a sanctuary in The Schedule hereto is a natural habitat or environment and having received all the necessary consents, do hereby declare the said land to be a sanctuary for the purposes of the said Act.

SANCTUARY NO. 96
The Schedule
BOOBOOK HILL SANCTUARY
Hundred of DUDLEY
Allotment 1 in DP 45769
Allotment 7 in DP 45770
Area 80 hectares (approx)

 Sanctuary

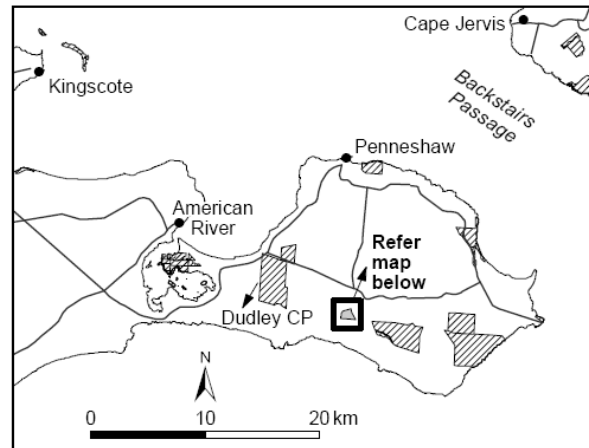

Location Map

Note: This is private land. Permission required before entry.

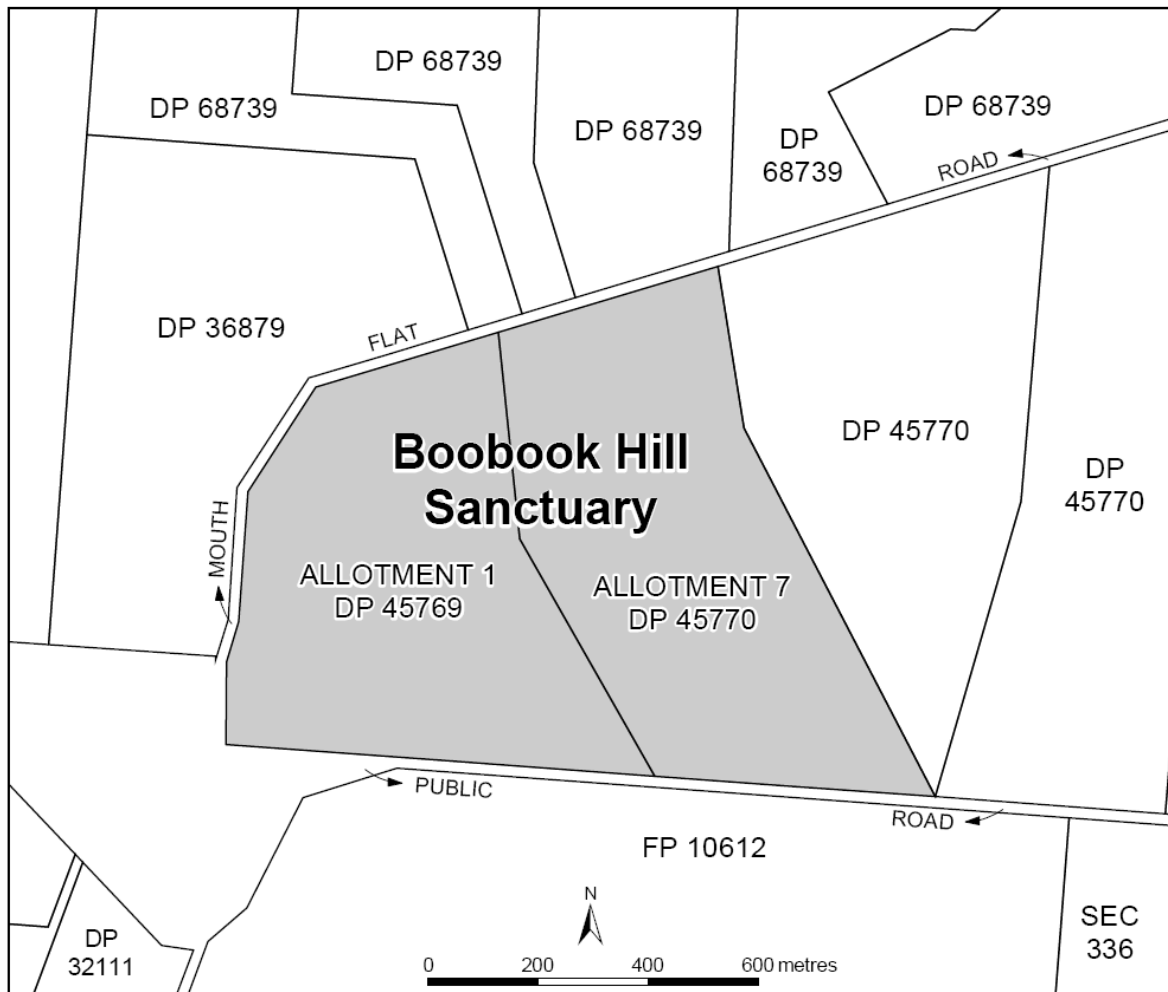

Dated 31 December 2009.

JAY WEATHERHILL, Minister for Environment and Conservation

NATIONAL PARKS AND WILDLIFE ACT 1972

Declaration of Yaitya-kauwingga Sanctuary

I, JAY WEATHERILL, Minister for Environment and Conservation for the time being administering the National Parks and Wildlife Act 1972, being of the opinion that it is desirable to conserve the animals and plants for which the land depicted as a sanctuary in The Schedule hereto is a natural habitat or environment and having received all the necessary consents, do hereby declare the said land to be a sanctuary for the purposes of the said Act.

SANCTUARY NO. 97
The Schedule
YAITYA-KAUWINGGA SANCTUARY
Hundred of Yankalilla
Allotment 1 in DP 70315
Area 55 hectares (approx)

 Sanctuary

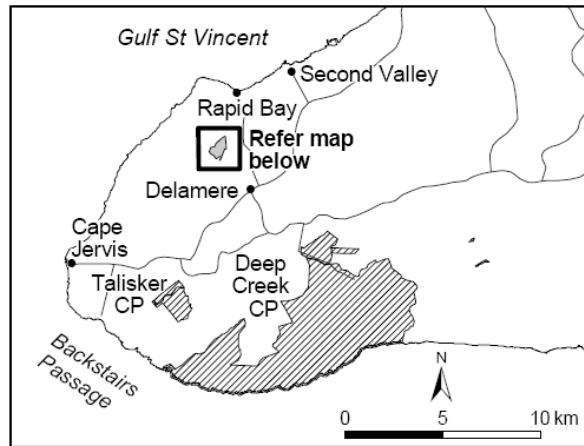

Location Map

Note: This is private land. Permission required before entry.

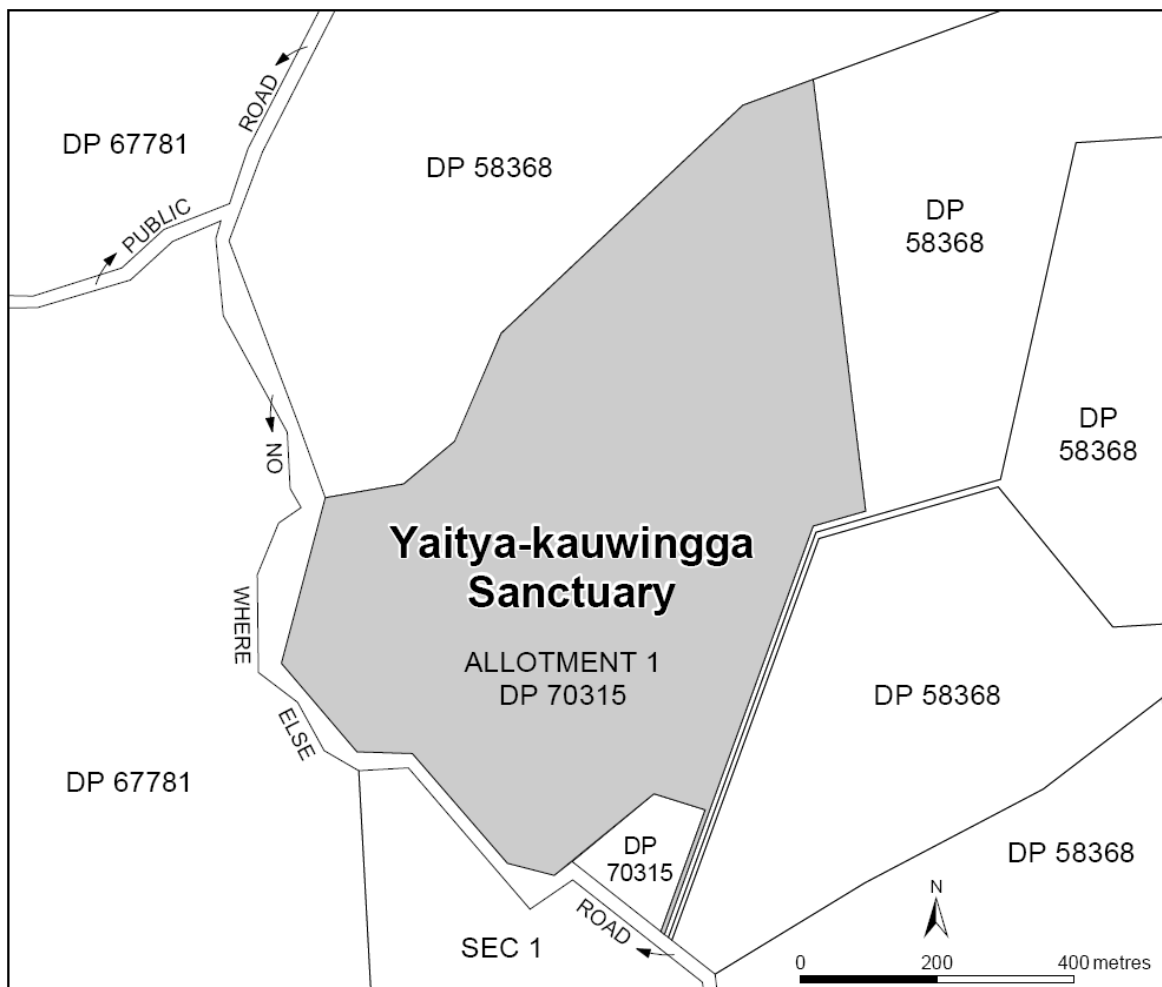

Dated 13 January 2010.

JAY WEATHERHILL, Minister for Environment and Conservation

NATIONAL PARKS AND WILDLIFE ACT 1972

Declaration of Sinclair's Gully Sanctuary

I, JAY WEATHERILL, Minister for Environment and Conservation for the time being administering the National Parks and Wildlife Act 1972, being of the opinion that it is desirable to conserve the animals and plants for which the land depicted as a sanctuary in The Schedule hereto is a natural habitat or environment and having received all the necessary consents, do hereby declare the said land to be a sanctuary for the purposes of the said Act.

SANCTUARY NO. 98
The Schedule
SINCLAIR'S GULLY SANCTUARY
Hundred of Adelaide
Allotment 3 in DP 39367
Area 8 hectares (approx)

 Sanctuary

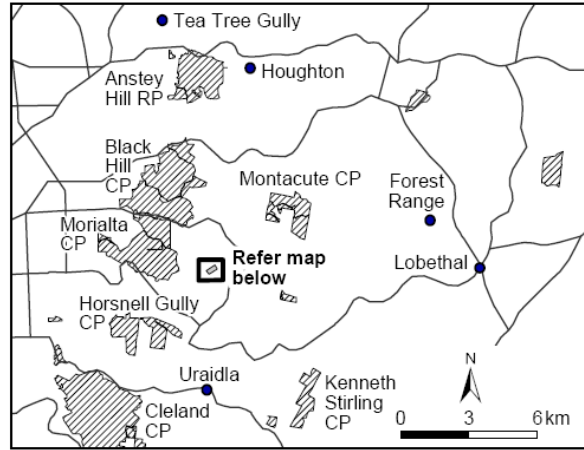

Location Map

Note: This is private land. Permission required before entry.

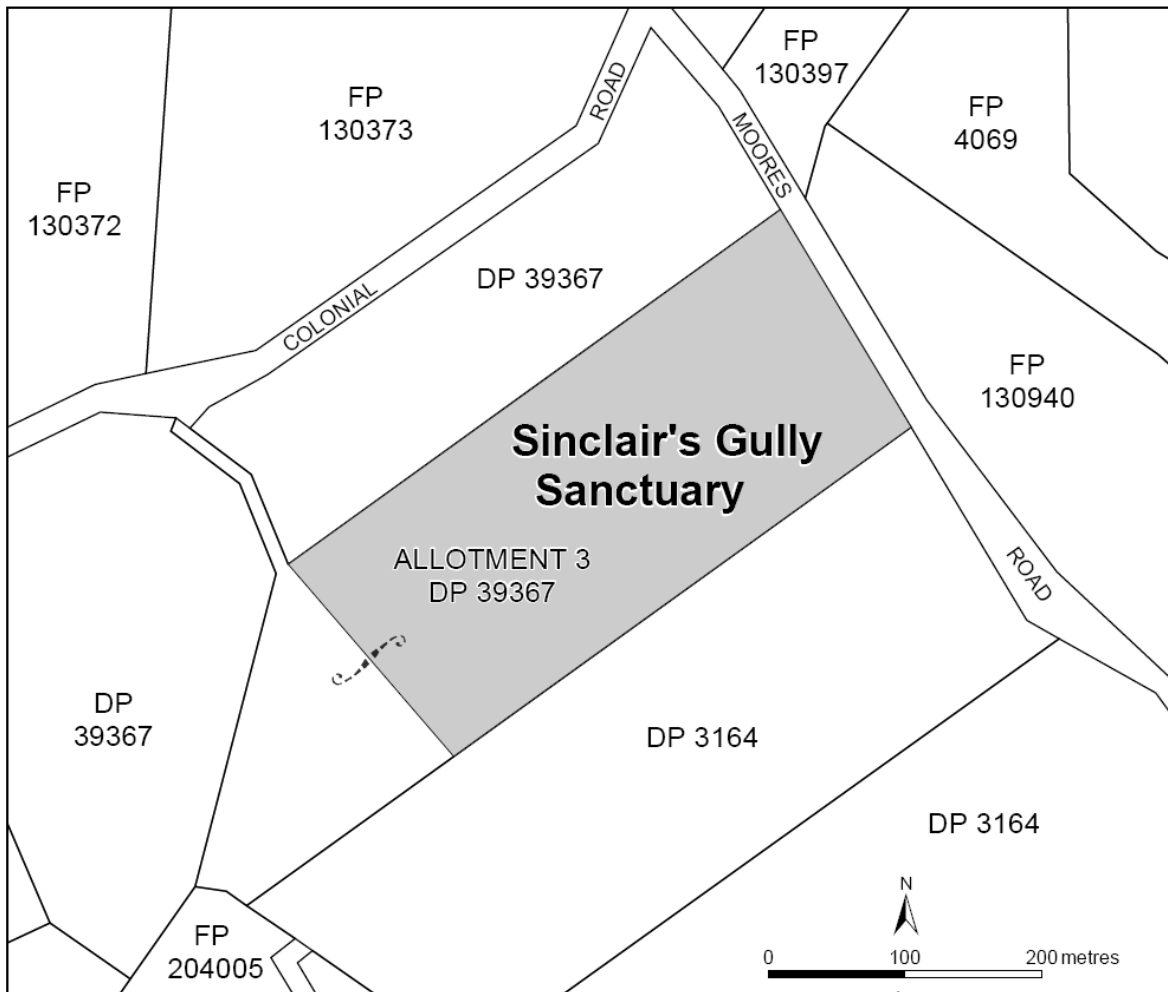

Dated 31 December 2009

JAY WEATHERHILL, Minister for Environment and Conservation

NURSES BOARD OF SOUTH AUSTRALIA (NBSA)

GUIDLINE ON ORDERS FOR COSTS

1. INTRODUCTION

- 1.1 The Nursing and Midwifery Board of South Australia ('the Board') has a discretionary power similar to that of the courts to order costs. The jurisdiction to make an award of costs is sourced from section 22(1) of the *Nursing and Midwifery Practice Act 2008* ('the Act'), which provides:

The Board may award such costs against a party to proceedings before it as the Board considers just and reasonable.

- 1.2 This Guideline sets out the Board's position on when it may be appropriate to order costs and the quantification of such costs. It is intended to provide guidance to Board members and promote consistency in decision-making. However, this Guideline is not intended to confine Board members to a rigidly mechanical approach as that would amount to an abdication of the discretion afforded by section 22(1) of the Act. This Guideline therefore provides no more than an indication of the course the Board may follow in deciding, on the facts of the particular case, whether to award costs and at what level.

2. NATURE OF DISCRETION TO AWARD COSTS

- 2.1 The breadth of language used in section 22(1) of the Act means that the discretion of the Board to make an order for costs against a party is absolute and unfettered.

- 2.2 Notwithstanding its breadth, by its very nature the discretion must be exercised judicially, that is to say, not arbitrarily, capriciously or so as to frustrate the legislative intent. This in itself carries with it the following restrictions as to its exercise:

2.2.1 Although discretionary, costs must necessarily be awarded on principle, not according to whim or private opinion. So it has been said that the discretion 'must be exercised on fixed principles, that is, according to rules of reason and justice, and not according to private opinion... or even benevolence... or sympathy'¹ and 'ought not to encourage arbitrary or capricious adjudication'.²

2.2.2 Judicial discretion is regulated by the principle of doing justice to the parties in each particular case, having regard to the particular circumstances of the case, including the evidence adduced, the parties' conduct and the ultimate result. There is, it is said, 'no better test than the test of what is fair and just between the parties', by reference to their conduct in connection with the litigation, including conduct which precedes it in so far as it bears on matters leading up to that litigation.³ A discretion exercised on grounds unconnected with the litigation, is not fair or just but arbitrary or capricious.

2.2.3 Any costs orders must be expressed in terms that are certain and/or ascertainable.

¹ *Williams v Lever* [1974] 2 NSWLR 91 at 95.

² *South Melbourne City Council v Hallam* {N0 2} (1994) 83 LGERA 307 at 312,

³ *Earnshaw v Loy (no 2)* [1959] VR 252 at 253.

3. MEANING OF COSTS

3.1 Generally speaking, the term 'costs' is taken to mean:

- 3.1.1 a solicitor's professional charges in respect of legal services rendered to a client; and
- 3.1.2 disbursements or out-of-pocket expenses incurred in the performance of those services.

3.2 Costs, broadly speaking, fall into two categories:

- 3.2.1 'Solicitor-client' costs, which represent the amount a client is obliged to pay his or her solicitor as the price of professional work. The amount of costs on this context may include disbursements.
- 3.2.2 'Party-party' costs, which are all costs which were necessary or proper for the attainment of justice or defending the rights of a party, but which does not include costs which were unnecessarily incurred or were special or unusual. Costs of this kind ordinarily include disbursements. Such costs are not as generous as solicitor-client.

3.3 As a general rule, costs are awarded or ordered on a party-party basis. Such an order is in the nature of a qualified (or partial) indemnity against the expense incurred and, as such, it does not extend to all costs which a party has incurred with his or her own solicitor.

4. GENERAL PRINCIPLES

4.1 In the normal course costs will follow the event. What this means, generally speaking, is that the successful party in the proceedings before the Board has, in the absence of special circumstances, a reasonable expectation of obtaining an order for the payment of costs by the unsuccessful party. Put another way, a successful party has a reasonable expectation of obtaining an order as to costs, unless there are clearly severable issues on which the other party has succeeded or for some reason the conduct of the successful party has been reprehensible.⁴

4.2 The general principle that costs follow the event does not fetter the Board's discretion. Thus whilst a successful party has a general expectation to receive costs, he or she has no entitlement to costs unless and until the Board awards them to him or her, and the Board has an unfettered discretion to award or not to award them.

4.3 An award of costs is to be in the nature of an indemnity against legal costs incurred in proceedings. The object of requiring an unsuccessful party to pay the costs of the successful party is to provide some indemnity to the successful party for the loss incurred in being required to spend money in vindicating or upholding his or her rights in legal proceedings. It follows that the indemnity nature of a costs order may well 'instil in a party contemplating, or defending, litigation a sober realisation of the potential financial expenses involved'.⁵

⁴ *Tramouna Armadora SA* (1978) 2 ALL ER 870.

⁵ *Oshlack v Richmond River Council* (1998) 193 CLR 72 at 97.

- 4.4 Indemnity is to be established on a party-party basis rather than on a solicitor-client basis.⁶ Thus, an award for costs in favour of a successful party is rarely a complete indemnity for the liability to his or her solicitor. The law recognises in most cases no more than a partial indemnity, reasoning that an unsuccessful party should not be required to indemnify the successful party any more than the latter's 'necessary or proper' costs.
- 4.5 Costs that may be claimed by a successful party include all necessary and proper legal costs incurred by him or her in the conduct of litigation. It is generally accepted that the quantum of costs to be allowed must include a proper sum in respect of all necessary preliminary work entailed and actually and properly done in taking instructions, proofing witnesses, and generally getting the matter up for trial or hearing and appearances before the court or other decision maker to present the client's case.
- 4.6 Costs associated with reporting to a client (e.g. attendances, letters etc) are generally not recoverable. Other examples of costs that may not be recoverable are costs associated with proofing witnesses who are not called, or who are called but not really necessary to prove the case.
- 4.7 Disbursements that may be claimed include the costs of counsel's fees for drawing or settling documents or for counsel's advice or opinion, conferences or a brief for an appearance; expert reports; witness fees and expenses (meals, accommodation, airfares or mileage etc); cancellation fees; service fees paid to a process server; transcript costs; photocopying expenses; and STD calls.
- 4.8 As an award for costs is to operate as an indemnity for legal costs incurred by a successful party, it follows that a successful unrepresented party in proceedings before the Board cannot recover costs from the other party. In such a case, the successful unrepresented party can recover only his or her proper and actual disbursements.
- 4.9 The Board does not have the power to make an award for costs against a person who is not a party to the proceedings before it.

⁶ *Medical Board of South Australia v Wong (No 2)* [1996] SADC 3540.

5. CIRCUMSTANCES WHERE COSTS ORDER MAY BE MADE IN 'ONE PARTY' PROCEEDINGS

- 5.1 Under the Act, there are a number of proceedings where there is only one party involved. These include hearings to determine applications for registration, enrolment and reinstatement. In such proceedings, the applicant is the only party to the proceedings, and the Crown who assists the Board cannot be said to be acting on behalf of a party as the Board itself is not a party to the proceedings. Section 22(1) of the Act does not therefore contemplate that a successful applicant for registration, enrolment or reinstatement will seek an order for costs as there is no other party against whom the Board may make an order of costs.
- 5.2 On the other hand, section 22(1) does empower the Board to award costs against an unsuccessful applicant. The Board may therefore order the unsuccessful applicant to pay to the Board an amount that will partly cover the expenses that the Board has incurred to hear and determine an application for registration, enrolment or reinstatement. Expenses that may be recouped by the Board from an unsuccessful applicant include members sitting fees, transcript costs and costs for the services of counsel assisting. This power, however, should be used judiciously, given that the applicant would have already paid an administration fee at the time of lodgement of the application.
- 5.3 Notwithstanding the ability to make an order against an unsuccessful applicant in registration, enrolment or reinstatement proceedings, it is envisaged that the Board will not exercise its discretion in that regard unless in exceptional circumstances. Situations where the Board may consider making a costs order against an unsuccessful applicant include:
- 5.3.1 where an application has been brought frivolously or vexatiously;
 - 5.3.2 where an application for registration, enrolment or reinstatement has been brought shortly after the Board had dismissed a similar application and where there has been no change in the circumstances of the applicant; or
 - 5.3.3 where the applicant acts improperly or unreasonably in a proceedings.

6. CIRCUMSTANCES WHERE COSTS ORDERS MAY BE MADE OR DENIED IN 'TWO-PARTY' PROCEEDINGS

- 6.1 Formal proceedings brought under Part 4 of the Act include:
- 6.1.1 Inquiries to determine complaints brought by the Registrar or the Minister alleging that a person registered or enrolled under the Act is medically unfit to provide nursing or midwifery care (section 60);
 - 6.1.2 Inquiries to determine complaints brought by the Registrar, the Minister, or an aggrieved person alleging that there is proper cause for disciplinary action against a person registered or enrolled under the Act, a services provider or a person occupying a position of authority in a corporate or trustee services provider (section 61); and
 - 6.1.3 Hearings to determine an application to vary and revoke conditions imposed by the Board in relation to a person's registration or enrolment (section 64).

- 6.2 Proceedings under Part 4 of the Act are inter partes (i.e. between parties) and involve at least two parties. In practice, proceedings pursuant to sections 61 and 62 are almost invariably brought by the Registrar as the complainant. The person that is the subject of the complaint/application is referred to as the respondent. Proceedings to vary and revoke conditions imposed by the Board must be commenced upon the application of a registered or enrolled person. In such proceedings both the Registrar and the Minister have standing to appear and be heard. Costs may be awarded against the Registrar who is a party to any proceedings before the Board.
- 6.3 In all these formal proceedings the Board expect parties and their paid representatives to act reasonably in pursuing their applications/complaints or defending their positions. This includes bringing applications/complaints only when there are substantial grounds. It also includes taking all required procedural steps, not taking unnecessary ones and acting in a courteous and orderly way at a hearing/inquiry.
- 6.4 In most cases costs ought to be ordered in favour of the successful party unless there are particular reasons connected with the case not to do so. A successful party will be disentitled to an order for costs if its conduct justifies that course. Examples of where the Board may decline to award the whole or part of the costs in favour of a successful party are:
- 6.4.1 Where the party has acted spitefully or has instituted or continued proceedings recklessly, in bad faith or without reasonable cause;
 - 6.4.2 Where the party has acted unreasonably or improperly in contesting or raising issues;
 - 6.4.3 Where the party has taken unnecessary steps in a proceeding;
 - 6.4.4 Where the party has engaged in misconduct at the hearing or in the proceeding;
 - 6.4.5 Where the party has acted contemptuously towards the Board or displayed a lack of respect for the process of the Board;
 - 6.4.6 Where the party has subsequently raised issues or made allegations which have caused a significant increase in the length or costs of the proceedings;
 - 6.4.7 Where the party has raised an issue which is irrelevant to the proceedings and continues to pursue that issue after the Board has pointed out that it is irrelevant;
 - 6.4.8 Where the party seeks adjournments without any justification;

- 6.4.9 Where the party has caused proceedings to be unduly protracted;
 - 6.4.10 Where the party has acted oppressively in cross-examining the other party's witnesses at length but not given evidence themselves; or
 - 6.4.11 Where the party has been successful on only certain aspects of the proceedings.
- 6.5 The Board has the power in proceedings to make an order for a party to pay both the legal costs of another party and to pay the Board's costs in the same case. However, such an order would only be made in exceptional circumstances. This would usually include the following:
- 6.5.1 A case in which a party clearly and knowingly misled the Board, such as filing false statements or documents;
 - 6.5.2 A case where a party was reckless or indifferent about the truthfulness of their evidence, such as stating that the other party did not serve a document which they know they received;
 - 6.5.3 Situations in which the party failed to comply with directions or orders of the Board about the orderly conduct of the hearing; and
 - 6.5.4 Where there is evidence of harassment of the other party to prevent the application/complaint or defence of the application/complaint.
- 6.6 Ordering a party to pay Board costs is not related to which party is successful. Since the reason such costs are awarded is to encourage proper conduct, it is conceivable that a successful party who adds unnecessary steps to the proceedings or behaves inappropriately at a hearing, may have to pay the Board's expenses for part of the proceedings.
- 6.7 As a general rule, it would be unlikely that the Registrar would seek an order for costs against an unsuccessful respondent in proceedings where it has been established that the respondent is medically unfit to provide nursing or midwifery care, especially where medical unfitness is due to a psychiatric condition or illness. However the Registrar may seek an order for costs in such proceedings where, for example, the respondent:
- 6.7.1 has unnecessarily and unreasonably caused proceedings to be protracted; or
 - 6.7.2 has vehemently defended the allegation of medical unfitness despite the existence of overwhelming documentary evidence, thus requiring the incursion of additional expense to call witnesses.

7. **SCALE OF COSTS**

- 7.1 In the absence of any statutory provision dictating the method in which the Board is to quantify costs, the Board has adopted the Criminal Scale of Costs applicable to the Magistrates Court (which is attached as 'Annexure A').

- 7.2 The Board has adopted a modest rather than a higher scale after taking into consideration the following factors:
- 7.2.1 the Board is analogous to a court or tribunal of inferior jurisdiction.
 - 7.2.2 legal members of the Board are not judge. Further, there is no requirement that a legal member sit in any proceeding before the Board.
 - 7.2.3 the majority of nurses and midwives, unlike other health professionals, are generally not self-employed. As such, they are not protected by professional indemnity and other insurance from the financial burden of defending themselves in disciplinary or medical fitness proceedings before the Board.
 - 7.2.4 nurses and midwives received rather modest remuneration when compared to other health professionals.

8. PROCEDURE

- 8.1 Parties to proceedings before the Board should be made aware from the outset that costs may be awarded for or against them.
- 8.2 An application for costs should only be made and entertained after the Board delivers its final findings in a matter.
- 8.3 Where an application for costs is made, each party should be afforded an opportunity to make submissions on the point.
- 8.4 The Board may request the party seeking the costs order to submit a summary of costs incurred, and then use that summary as the basis of its determination, having regard to the relevant scale adopted by the Board.
- 8.5 The determination of whether it is just and reasonable to make an order for costs against a party is for the hearing committee or panel to determine jointly. Alternatively, in Part 4 proceedings, the question of costs may be heard and determined by the member presiding over the proceedings sitting alone.
- 8.6 A lump or global sum which the Board considers just and reasonable may be awarded. It would not be appropriate to award costs on an item to item basis.
- 8.7 Where the parties to proceedings have reached an agreement as to the allocation of costs, or as to their quantification, this does not by itself oust the Board's jurisdiction to order an alternative allocation or quantification. However, the Board would be most reticent to act inconsistently with any consensus as to costs that have been the subject of an agreement between the parties.
- 8.8 If and once an order for costs has been made against a party, the Board is functus officio and has no further authority on that issue. A party who is dissatisfied with the amount of the costs awarded by the Board may request a Master of the District Court to tax the costs and, after taxing the costs, the Master may confirm or vary the amount of the costs awarded by the Board.

'ANNEXURE A'**Magistrates Court Criminal Scale of Costs***Effective from 17 April 2008***Notes:**

- 1 This cost scale is intended for use in making orders as between party and party.
- 2 The fees set out in item 1 and 2 are intended to cover all necessary attendances and preparatory work for a trial (other than attendance at a pre-trial conference). Where an attendance is unnecessary as a result of default by one or other party, an order should be sought and made at that hearing. The fee set out in item 4 or 5 should be used for that purpose.

No.	Item	Represented by solicitor	Represented by non-legally qualified person
1	Instructions, including all preparation for trial and attendances up to, but not including attendance at a Pre Trial Conference	\$900	\$225
2	All aspects not otherwise specified from Pre-Trial Conference to Trial, including proofing witnesses, advice or evidence and law (solicitor and counsel) and delivering brief to counsel.	\$900	\$225
3	Attendance at pre-trial conference	\$250	\$60
4	Attendance at hearing (see note 2 above)	\$90	\$25
5	Attendance where detailed argument is necessary (see note 2 above)	\$150	\$35
6	Arranging attendance of witnesses (including issue and service of summons if necessary) - per witness	\$60	\$15
	Counsel fees		
7	Fee on brief, to include attendance for plea or withdrawal (if separate counsel briefed)	\$800	200
8	Each day	\$1 250	\$300

Witness fees	
Professional scientific or other expert witnesses per day	\$600 or such amount ordered by the Court
Other adult person per day	\$300
Persons under 18 years of age per day	\$120
Travel expenses	Where the witness is normally resident more than 50 km from the trial Court at the rate of 70 cents per km or the least expensive return air fare whichever is the lesser or the cheapest combination of both.
Accommodation expenses	In the discretion of the taxing officer where the witness is required to be absent from his or her normal place of residence overnight for accommodation and sustenance per night \$240 or such larger amounts allowed by the Court at the time of or before judgment.
Photocopying	50 cents per page
STD calls	The actual cost.
Expert Reports	\$550 or such other amount ordered by the Court
Other	All Court fees, search fees, and other fees and payments to the extent to which they have been properly and reasonably incurred and paid; but excluding the usual and incidental expenses and overheads of a legal practice and in particular excluding postage, telephone charges (non STD) and courier expenses.
NOTE :	
A If a witness is released before or is required to first attend after the luncheon break on any day, half a day will be allowed.	

Prepared by:
Joseph Nguyen
 Senior Solicitor, Crown Solicitor's Office
 23 September 2009

Approved by:
**Nursing and Midwifery Board of
 South Australia**
 2 October 2009

COMMONWEALTH OF AUSTRALIA
OFFSHORE PETROLEUM AND GREENHOUSE GAS STORAGE ACT 2006

Cancellation of Exploration Permit for Petroleum EPP 36

NOTICE is hereby given that Exploration Permit for Petroleum EPP 36 held by:

Exoil Limited, Level 21, 500 Collins Street, Melbourne, Vic. 3000;	Gascorp Australia Limited, Level 21, 500 Collins Street, Melbourne, Vic. 3000;
Moby Oil & Gas Limited, Level 21, 500 Collins Street, Melbourne, Vic. 3000;	National Energy Pty Ltd, Level 21, 500 Collins Street, Melbourne, Vic. 3000;

in respect of the blocks described hereunder, is hereby cancelled.

Description of Blocks

The reference hereunder is to the name of the map sheets of the 1:1 000 000 series prepared and published for the purposes of the Offshore Petroleum and Greenhouse Gas Storage Act 2006 and to the numbers of graticular sections shown thereon:

Map Sheet SJ 54.

BLOCK NUMBERS:

1892	1893	1894	1895	1896	1897
1898	1964	1965	1966	1967	1968
1969	1970	1971	1972	2037	2038
2039	2040	2041	2042	2043	2044
2045	2046	2111	2112	2113	2114
2115	2116	2117	2118	2119	2120
2121	2122 Part	2123 Part	2184	2185	2186
2187	2188	2189	2190	2191	2192
2193	2194 Part	2258	2259	2260	2261
2262	2263	2264	2265 Part	2266 Part	2332
2333	2334	2335	2336 Part	2337 Part	2406
2407 Part	2408 Part				

Assessed to contain 68 blocks.

Dated 2 February 2010.

E. ALEXANDER,

Acting Director Petroleum and Geothermal
Delegate of the Designated Authority
Minerals and Energy Division, PIRSA
for and on behalf of the Commonwealth—South Australia Offshore Petroleum Joint Authority

Made under the Offshore Petroleum and Greenhouse Gas Storage Act 2006 of the Commonwealth of Australia.

TRAINING AND SKILLS DEVELOPMENT ACT 2008**Part 4—Apprenticeships/Traineeships**

Pursuant to the provision of the Training and Skills Development Act 2008, the Training and Skills Commission (TaSC) gives notice that determines the following Trades or Declared Vocations in addition to the gazette notices of:

- | | | | |
|----------------------|---------------------|-----------------------|-----------------------|
| 1. 25 September 2008 | 2. 23 October 2008 | 3. 13 November 2008 | 4. 4 December 2008 |
| 5. 18 December 2008 | 6. 29 January 2009 | 7. 12 February 2009 | 8. 5 March 2009 |
| 9. 12 March 2009 | 10. 26 March 2009 | 11. 30 April 2009 | 12. 18 June 2009 |
| 13. 25 June 2009 | 14. 27 August 2009 | 15. 17 September 2009 | 16. 24 September 2009 |
| 17. 9 October 2009 | 18. 22 October 2009 | 19. 3 December 2009 | 20. 17 December 2009 |

**Trades or Declared Vocations and Required Qualifications and Training Contract
Conditions for the
Community Services Training Package (CHC08)**

*Trade/#Declared Vocation/Other Occupation	Code	Title	Nominal Term of Contract of Training	Probationary Period
Aged Care Worker	CHC40108	Certificate IV in Aged Care	24	2
Aged Care Worker Disability Worker Community Worker	CHC40208	Certificate IV in Home and Community Care	24	2
Disability Worker	CHC40308	Certificate IV in Disability	24	2
Alcohol & Other Drugs Worker	CHC40408	Certificate IV in Alcohol and Other Drugs	24	2
Mental Health (Non-Clinical Worker)	CHC40508	Certificate IV in Mental Health	24	2
Aged Care Worker Disability Worker Mental Health (Non-Clinical Worker)	CHC40608	Certificate IV in Leisure and Health	24	2
Children's Services Worker	CHC41208	Certificate IV in Children's Services (Outside School Hours Care)	24	2
Child Protection, Statutory Supervision, Juvenile Justice Worker	CHC41408	Certificate IV in Child, Youth and Family Intervention (Residential and Out of Home Care)	24	2
Child Protection, Statutory Supervision, Juvenile Justice Worker	CHC41508	Certificate IV in Child, Youth and Family Intervention (Child Protection)	24	2
Child Protection, Statutory Supervision, Juvenile Justice Worker	CHC41608	Certificate IV in Child, Youth and Family Intervention (Family Support)	24	2
Youth Worker Child Protection, Statutory Supervision, Juvenile Justice Worker	CHC41908	Certificate IV in Youth Justice	24	2

*Trade/#Declared Vocation/Other Occupation	Code	Title	Nominal Term of Contract of Training	Probationary Period
Disability Worker	CHC42008	Certificate IV in Employment Services	24	2
Disability Worker	CHC50108	Diploma of Disability	36	3
Alcohol and Other Drugs Worker	CHC50208	Diploma of Community Services (Alcohol and other Drugs)	36	3
Alcohol and Other Drugs Worker	CHC50208	Diploma of Community Services (Alcohol and other Drugs)	36	3
Alcohol and Other Drugs Worker Community Worker Mental Health (Non-Clinical Worker)	CHC50408	Diploma of Community Services (Alcohol, other Drugs and Mental Health)	36	3
Children's Services Worker	CHC51108	Diploma of Children's Contact Services Work	36	3
Child Protection, Statutory Supervision, Juvenile Justice Worker	CHC51208	Diploma of Child, Youth and Family Intervention	36	3
Alcohol and Other Drugs Worker Community Worker Disability Worker Mental Health (Non-Clinical Worker) Youth worker	CHC52008	Diploma of Community Services (Case Management)	36	3
Community Worker	CHC52108	Diploma of Community Services (Financial Counselling)	36	3
Aged Care Worker Alcohol and Other Drugs Worker Community Worker Disability Worker Mental Health (Non-Clinical Worker) Youth Worker	CHC52208	Diploma of Community Services Co-ordination	24	2
Disability Worker	CHC60108	Advanced Diploma of Disability	36	3
Children's Services Worker	CHC60208	Advanced Diploma of Children's Services	48	3
Aged Care Worker	CHC60308	Advanced Diploma of Community Sector Management	48	3

PETROLEUM AND GEOTHERMAL ENERGY ACT 2000

Statement of Environmental Objectives for Existing Regulated Activities

PURSUANT to section 104 (1) of the Petroleum and Geothermal Energy Act 2000 (the Act) I, Michael Malavazos, Acting Director Petroleum and Geothermal, Minerals and Energy Resources Division, Department of Primary Industries and Resources SA, Delegate of the Minister for Mineral Resources Development, pursuant to Delegation dated 1 October 2009, *Gazetted*, 1 October 2009, do hereby publish the following document as having been approved as a statement of environmental objectives under the Act.

Document:

1. Riverland Natural Gas Transmission Pipeline (Pipeline Licence 6) Statement of Environmental Objectives, January 2010.

This document is available for public inspection on the Environmental Register section of the Petroleum and Geothermal Group's website (www.pir.sa.gov.au/petrol/envreg) or at the Public Office determined, pursuant to section 107 (1) of the Act to be at:

Office of Minerals and Energy Resources,
Customer Services,
Level 7, 101 Grenfell Street,
Adelaide, S.A. 5000.

Dated 1 February 2010.

M. MALAVAZOS,
Acting Director Petroleum and Geothermal
Delegate of the Minister for
Mineral Resources Development

PETROLEUM AND GEOTHERMAL ENERGY ACT 2000

Suspension of Geothermal Exploration Licence—GEL 169

PURSUANT to section 90 of the Petroleum and Geothermal Energy Act 2000, notice is hereby given that the abovementioned Geothermal Exploration Licence has been suspended under the provisions of the Petroleum and Geothermal Energy Act 2000, from and including 29 January 2010 until 28 April 2010, pursuant to delegated powers dated 1 October 2010.

The expiry date of GEL 169 is now determined to be 2 May 2011.

Dated 2 February 2010.

E. M. ALEXANDER,
Acting Director Petroleum and Geothermal
Minerals and Energy Resources
Primary Industries and Resources SA
Delegate of the Minister for Mineral
Resources Development

PUBLIC SECTOR ACT 2009

Chief Executive, Zero Waste SA

I, JAY WEATHERILL, the Minister for Environment and Conservation hereby declare pursuant to section 40 (a) of the Public Sector Act 2009 that Vaughan John Levitzke will have the powers and functions of Chief Executive in relation to the Office of Zero Waste SA for dates consistent with his re-appointment under the Zero Waste SA Act 2004.

Dated 4 February 2010.

JAY WEATHERILL, Minister for Environment
and Conservation

ROAD TRAFFIC ACT 1961

Authorised Officers to Conduct Breath Analysis

I, MALCOLM ARTHUR HYDE, Commissioner of Police, pursuant to section 47K (3) (a) of the Road Traffic Act 1961, do hereby certify that on 28 January 2010, the following Police Officers were authorised to conduct breath analysis:

PD Number	Officer Name
358	Adamson, David Beveridge
92850	Anderson, Lindsay Perry

PD Number	Officer Name
-----------	--------------

72866	Daniels, Jamie
72613	Jarc, Jessica Anne
72493	Johnson, Timothy Christopher
73225	Moriarty, Daniel Christopher
79613	Shephard, Derek Ian
72391	Shephard, Shane Michael
72144	Watts, Luke Ross

Dated 28 January 2010.

MALCOLM ARTHUR HYDE, Commissioner of Police

WATER MAINS AND SEWERS

Office of the South Australian Water Corporation
Adelaide, 4 February 2010

WATER MAINS LAID

Notice is hereby given that the following main pipes or parts of main pipes have been laid down by the South Australian Water Corporation in or near the undermentioned water districts and are now available for a constant supply of water to adjacent land.

ADELAIDE WATER DISTRICT

CITY OF CHARLES STURT
Birch Avenue, Flinders Park. p14
Moody Street, Woodville West. p17

CITY OF ONKAPARINGA
Gulf Parade, Maslin Beach. p16

CITY OF PORT ADELAIDE ENFIELD
Prescott Street, Clearview. p12

CITY OF SALISBURY
Edinburgh Road, Direk. p13

BORDERTOWN WATER DISTRICT

TATIARA DISTRICT COUNCIL
In and across Ramsay Terrace, Bordertown. p32

HASLAM WATER DISTRICT

DISTRICT COUNCIL OF STREAKY BAY
Across and in East Terrace, Haslam. p15

MILANG WATER DISTRICT

ALEXANDRINA COUNCIL
Chapel Street, Milang. p2

WALLAROO WATER DISTRICT

DISTRICT COUNCIL OF THE COPPER COAST
Scotland Street, Wallaroo. p1
Young Street, Wallaroo. p1

WATER MAINS ABANDONED

Notice is hereby given that the undermentioned water mains have been abandoned by the South Australian Water Corporation.

BORDERTOWN WATER DISTRICT

TATIARA DISTRICT COUNCIL
Ramsay Terrace, Bordertown. p32

MILANG WATER DISTRICT

ALEXANDRINA COUNCIL
Chapel Street, Milang. p2

MOONTA WATER DISTRICT

DISTRICT COUNCIL OF THE COPPER COAST
Moonta Road, Moonta Bay. p24

MOOROOK WATER DISTRICT

DISTRICT COUNCIL OF LOXTON WAIKERIE
In crown land (section 650, hundred of Moorook), Kingston-Loxton Road, Moorook South. p10

MOOROOK COUNTRY LANDS WATER DISTRICT

DISTRICT COUNCIL OF LOXTON WAIKERIE
In and across Kingston-Loxton Road, Moorook South. p10
In pipeline reserve (section 636, hundred of Moorook), Kingston-Loxton Road, Moorook South.

WALLAROO WATER DISTRICT

DISTRICT COUNCIL OF THE COPPER COAST
Scotland Street, Wallaroo. p1

WATER MAINS LAID

Notice is hereby given that the undermentioned water mains have been laid down by the South Australian Water Corporation and are not available for a constant supply of water to adjacent land.

MOOROOK WATER DISTRICT

DISTRICT COUNCIL OF LOXTON WAIKERIE
In crown land (section 650, hundred of Moorook), Kingston-Loxton Road, Moorook South. p10

MOOROOK COUNTRY LANDS WATER DISTRICT

DISTRICT COUNCIL OF LOXTON WAIKERIE
In and across Kingston-Loxton Road, Moorook South. This main is available on application—not available for constant rateable supply. p10
In pipeline reserve (section 636, hundred of Moorook), Kingston-Loxton Road, Moorook South. This main is available on application—not available for constant rateable supply. p10

SEWERS LAID

Notice is hereby given that the following sewers have been laid down by the South Australian Water Corporation in the undermentioned drainage areas and are now available for house connections.

ADELAIDE DRAINAGE AREA

CITY OF BURNSIDE
Across Cooper Angus Grove, Wattle Park. FB 1103 p41
Wanbrow Avenue, Wattle Park. FB 1103 p41

CITY OF CHARLES STURT
Birch Avenue, Flinders Park. FB 1189 p19
Across Gawler Street, Woodville West. FB 1189 p20
Moody Street, Woodville West. FB 1189 p20
George Street, Beverley. FB 1189 p24
May Street, Woodville West. FB 1189 p25
Stacy Street, Hendon. FB 1189 p37

CITY OF MARION
Harrow Street, Dover Gardens. FB 1189 p27
Yanyarrie Avenue, Edwardstown. FB 1189 p28

CITY OF MITCHAM
Easement in reserve (lot 140 in LTRO DP 9422), Johnson Parade, Blackwood. FB 1109 p4
Across Johnson Parade, Blackwood. FB 1109 p4
Easement in lot 115 in LTRO DP 9422, Johnson Parade and lot 57 in LTRO FP 149342, Hovea Street, Blackwood. FB 1109 p4
Across Hovea Street, Blackwood. FB 1109 p4
Goldney Grove, Hawthorndene. FB 1189 p29

CITY OF ONKAPARINGA
States Road, Morphett Vale. FB 1189 p22
Powers Avenue, Morphett Vale. FB 1189 p23

Muirfield Place, Morphett Vale. FB 1189 p30
Walnut Street, Old Reynella. FB 1189 p31

CITY OF PORT ADELAIDE ENFIELD
Mary Street, Ethelton. FB 1109 p5
Across Latrobe Street, Blair Athol. FB 1189 p32
Southport Street, Blair Athol. FB 1189 p32
Galway Terrace, Largs North. FB 1189 p33
Robert Avenue, Clearview. FB 1189 p35
Southbury Road, Enfield. FB 1189 p36

CITY OF TEA TREE GULLY
Easement in reserve (lot 41 in LTRO DP 23454), Quinton Court, Wynn Vale. FB 1189 p34
Quinton Court, Wynn Vale. FB 1189 p34

ALDINGA DRAINAGE AREA

CITY OF ONKAPARINGA
Aldinga Beach Road, Aldinga. FB 1189 p26

MURRAY BRIDGE COUNTRY DRAINAGE AREA

THE RURAL CITY OF MURRAY BRIDGE
Prosperity Grove, Murray Bridge. FB 1162 p11 and 12
Commerce Road, Murray Bridge. FB 1162 p11 and 12
Across Maurice Road, Murray Bridge. FB 1162 p11 and 12
Stableford Court, Murray Bridge. FB 1162 p11 and 12
Across Rachel Street, Murray Bridge. FB 1161 p15
Easement in lot 102 in LTRO DP 79451, Rachel Street and lot 100 in LTRO DP 79451, Bridge Lane, Murray Bridge. FB 1161 p15

PORT PIRIE COUNTRY DRAINAGE AREA

PORT PIRIE REGIONAL COUNCIL
Broadway Road, Port Pirie West—375 mm PVC pumping main. FB 1189 p21

SEWERS ABANDONED

Notice is hereby given that the undermentioned sewers have been abandoned by the South Australian Water Corporation.

ADELAIDE DRAINAGE AREA

CITY OF BURNSIDE
Across Cooper Angus Grove, Wattle Park. FB 1103 p41
Wanbrow Avenue, Wattle Park. FB 1103 p41

CITY OF MITCHAM
Easement in reserve (lot 140 in LTRO DP 9422), Johnson Parade, Blackwood. FB 1109 p4
Across Johnson Parade, Blackwood. FB 1109 p4
Easement in lot 115 in LTRO DP 9422, Johnson Parade and lot 57 in LTRO FP 149342, Hovea Street, Blackwood. FB 1109 p4
Across Hovea Street, Blackwood. FB 1109 p4

CITY OF PORT ADELAIDE ENFIELD
Mary Street, Ethelton. FB 1109 p5

PORT PIRIE COUNTRY DRAINAGE AREA

PORT PIRIE REGIONAL COUNCIL
Broadway Road, Port Pirie West—375 mm AC pumping main. FB 1189 p21

SEWERS LAID

Notice is hereby given that the undermentioned sewer has been laid down by the South Australian Water Corporation and is not available for house connections.

ADELAIDE DRAINAGE AREA

CITY OF PORT ADELAIDE ENFIELD
Sewerage land (lot 38 in LTRO DP 29121), Capelli Road, Wingfield. FB 1189 p18

A. HOWE, Chief Executive Officer, South Australian Water Corporation

South Australia

Commonwealth Powers (De Facto Relationships) Act (Commencement) Proclamation 2010

1—Short title

This proclamation may be cited as the *Commonwealth Powers (De Facto Relationships) Act (Commencement) Proclamation 2010*.

2—Commencement of Act and suspension of a certain provision

- (1) The *Commonwealth Powers (De Facto Relationships) Act 2009* (No 86 of 2009) will come into operation on 1 July 2010.
- (2) The operation of section 4(1)(b) of the Act is suspended until a day or time to be fixed by subsequent proclamation.

Made by the Governor

with the advice and consent of the Executive Council
on 4 February 2010

10AGO0104

South Australia

Administrative Arrangements (Administration of Commonwealth Powers (De Facto Relationships) Act Proclamation 2010

under section 5 of the *Administrative Arrangements Act 1994*

1—Short title

This proclamation may be cited as the *Administrative Arrangements (Administration of Commonwealth Powers (De Facto Relationships) Act) Proclamation 2010*.

2—Commencement

This proclamation comes into operation on the day on which it is made.

3—Administration of Act committed to Attorney-General

The administration of the *Commonwealth Powers (De Facto Relationships) Act 2009* is committed to the Attorney-General.

Made by the Governor

with the advice and consent of the Executive Council
on 4 February 2010

10AGO0104

South Australia

Liquor Licensing (Conferral of Authority) Proclamation 2010

under section 15 of the *Liquor Licensing Act 1997*

1—Short title

This proclamation may be cited as the *Liquor Licensing (Conferral of Authority) Proclamation 2010*.

2—Commencement

This proclamation comes into operation on the day on which it is made.

3—Conferral of authority on District Court Judges

Authority is conferred on the District Court Judges named in Schedule 1 to exercise the jurisdiction of the Licensing Court of South Australia.

Schedule 1—District Court Judges on whom authority is conferred

Her Honour Anne Bampton

His Honour Simon Frederick Stretton

Made by the Governor

with the advice and consent of the Executive Council
on 4 February 2010

AGO0071/03CS

South Australia

Tobacco Products Regulation (Exemption) Proclamation 2010

under section 71 of the *Tobacco Products Regulation Act 1997*

1—Short title

This proclamation may be cited as the *Tobacco Products Regulation (Exemption) Proclamation 2010*.

2—Commencement

This proclamation comes into operation on the day on which it is made.

3—Interpretation

In this proclamation—

Act means the *Tobacco Products Regulation Act 1997*;

prescribed period means the period commencing on 24 February 2010 and ending on 24 March 2010;

prescribed production means that part of the stage production of *NIDA: Sex Wars* comprised of the play *Motel* produced by the National Institute of Dramatic Art.

4—Application of proclamation

This proclamation applies to the following persons:

- (a) a person employed by, or in relation to, the prescribed production;
- (b) an occupier of the Bakehouse Theatre at 255 Angas Street, Adelaide;
- (c) an employer with responsibility for a workplace consisting of the Bakehouse Theatre in relation to the prescribed production.

5—Exemption from section 46 of the Act

- (1) A person to whom this proclamation applies is exempt from the operation of section 46 of the Act in relation to smoking occurring in the course of a performance or rehearsal of the prescribed production during the prescribed period.
- (2) An exemption under this clause is subject to the following conditions:
 - (a) smoking may only occur on a stage on which the prescribed production is being performed or rehearsed, or in a rehearsal room used in relation to the prescribed production;
 - (b) the area in which smoking may occur under the exemption must be well ventilated;
 - (c) a person may only smoke a tobacco product of a kind contemplated by paragraph (g) of the definition of *tobacco product* in section 4 of the Act.

- (3) If a person contravenes or fails to comply with a condition of an exemption specified in subclause (2), the exemption does not, while the contravention or non-compliance continues, operate in that person's favour.

Made by the Governor

with the advice and consent of the Executive Council
on 4 February 2010

HEACS10/004CS

South Australia

Electricity (Principles of Vegetation Clearance) Regulations 2010

under the *Electricity Act 1996*

Contents

- 1 Short title
- 2 Commencement
- 3 Interpretation
- 4 Duty of electricity entity or council
- 5 Duty of occupier
- 6 Planting and nurturing vegetation near powerlines
- 7 Technical Regulator may grant exemption from principles of vegetation clearance
- 8 Vegetation clearance scheme outside prescribed areas agreed between council and electricity entity
- 9 Agreement between occupier and electricity entity
- 10 Objections relating to vegetation clearance
- 11 Notification of clearance by electricity entity to council

Schedule 1—Clearance and buffer zones around overhead powerlines

- 1 Legend for diagrams
- 2 Clearance zone around overhead powerlines on public land in a non-bushfire risk area
- 3 Clearance and buffer zones around overhead powerlines on private land in a non-bushfire risk area
- 4 Clearance and buffer zones around overhead powerlines in the bushfire risk area
- 5 Tables for determination of value of V, H, B, S and P
- 6 Technical Regulator may determine values for clearance zone around particular powerline in certain circumstances

Schedule 2—Planting or nurturing vegetation near public powerlines

- 1 Interpretation
- 2 General rules
- 3 Exemption
- 4 Tables

Schedule 3—Maps showing prescribed areas

Schedule 4—Maps showing bushfire risk area

Schedule 5—Revocation and transitional provisions

Part 1—Revocation

- 1 Revocation of *Electricity (Principles of Vegetation Clearance) Regulations 1996*

Part 2—Transitional provisions

- 2 Interpretation

3	Agreements with occupiers
4	Vegetation clearance schemes with councils
5	Exemptions

1—Short title

These regulations may be cited as the *Electricity (Principles of Vegetation Clearance) Regulations 2010*.

2—Commencement

These regulations come into operation on the day on which they are made.

3—Interpretation

- (1) In these regulations, unless the contrary intention appears—

Act means the *Electricity Act 1996*;

buffer zone, in relation to an overhead powerline in the bushfire risk area or on private land in a non-bushfire risk area, means the space around the powerline that adjoins the clearance zone around that powerline, as shown in the diagrams in Schedule 1;

bushfire risk area means the part of the State shown in the maps in Schedule 4 as the bushfire risk area excluding the areas shown in those maps as non-bushfire risk areas (also see subregulation (4));

centreline in relation to a powerline means—

- (a) in the case of an underground powerline—
 - (i) that consists of a single conductor—an imaginary line on the ground directly above that conductor; or
 - (ii) that consists of more than 1 conductor—an imaginary line on the ground above the powerline that is equidistant from the outer conductors; or
- (b) in the case of an overhead powerline—
 - (i) that consists of a single conductor—an imaginary line on the ground directly beneath the position maintained by that conductor in still air; or
 - (ii) that consists of more than 1 conductor—an imaginary line on the ground below the powerline that is equidistant from the positions maintained by the outer conductors in still air;

clearance zone means the space around an overhead powerline as shown in the diagrams in Schedule 1 (the values of V, H, B, S and P referred to in those diagrams being determined by reference to the tables in Schedule 1 clause 5 or, if a determination of the Technical Regulator under Schedule 1 clause 6 is in force in relation to a particular powerline, that determination);

low risk powerline means an overhead powerline or portion of an overhead powerline—

- (a) that is in a prescribed area; and
- (b) each span of which does not exceed 50 metres and has low voltage conductors;

low voltage conductor means a conductor constructed to operate at a voltage not exceeding 480V;

non-bushfire risk area means a part of the State not within the bushfire risk area (also see subregulation (4));

prescribed area—see subregulation (3);

private powerline—see subregulation (2);

public land means land other than private land;

span, in relation to an overhead powerline, means the part of the powerline that lies between 2 poles or other supports for that line.

- (2) For the purposes of the definition of **private powerline** in section 4(1) of the Act, the prescribed voltage is 19kV.
- (3) For the purposes of Part 5 of the Act and these regulations, each non-bushfire risk area (or portion of a non-bushfire risk area) that is shown on the map in Schedule 5 headed *Portion of Greater Metropolitan Area of Adelaide showing Index to Prescribed Areas Map Sheets* (and in more detail on the following 7 maps indexed on that map) is a **prescribed area**.
- (4) A map of a **bushfire risk area** or **non-bushfire risk area** is to be interpreted as at the date of its inclusion in the *Electricity (Principles of Vegetation Clearance) Regulations 1996* revoked by these regulations or, if it was not included in those regulations, as at the date of its inclusion in these regulations.

4—Duty of electricity entity or council

- (1) The principles of vegetation clearance set out in this regulation are prescribed for the purposes of Part 5 of the Act and govern the duty of an electricity entity or a council to take reasonable steps to keep vegetation clear of powerlines.
- (2) At intervals of no longer than 3 years, overhead powerlines must be inspected and vegetation cleared as follows:
 - (a) in the case of powerlines other than low risk powerlines—vegetation must be cleared so that—
 - (i) no vegetation remains in the clearance zone surrounding the powerline in still air at the time of the clearance; and
 - (ii) no growth or regrowth is likely to intrude into the clearance zone within 3 years (or, if an inspection and clearance is scheduled to take place in less than 3 years, within that lesser period), taking into account the reasonably ascertainable characteristics of the powerline and vegetation; and
 - (iii) no part of the vegetation or growth or regrowth is likely to bend in the wind into the clearance zone at the time of clearance or within 3 years (or, if an inspection and clearance is scheduled to take place in less than 3 years, within that lesser period), taking into account the reasonably ascertainable characteristics of the powerline and vegetation and winds that might reasonably be expected in the area; and
 - (b) in the case of low risk powerlines—vegetation must be cleared—
 - (i) in accordance with the principles set out in paragraph (a); or
 - (ii) so that no part of the vegetation or growth or regrowth is likely to come into contact with the powerline (including by bending in the wind) so as to—
 - (A) form a leakage current to ground through the vegetation resulting in a risk of fire or electric shock; or

- (B) form an electrical path for tracking voltage exceeding 480V into low voltage conductors; or
 - (C) bridge 2 or more low voltage conductors resulting in a phase to phase or phase to neutral breach; or
 - (D) cause damage to the powerline resulting in a risk of fire, electric shock or loss of electricity supply,
at the time of the clearance or within 3 years (or, if an inspection and clearance is scheduled to take place in less than 3 years, within that lesser period), taking into account the reasonably ascertainable characteristics of the powerline and the vegetation and winds that might reasonably be expected in the area.
- (3) If the supporting structure of a low risk powerline also supports conductors that are not low voltage conductors, then—
- (a) the principles set out in subregulation (2)(a) apply in relation to the conductors that are not low voltage conductors; and
 - (b) the principles set out in subregulation (2)(b) apply in relation to the low voltage conductors.
- (4) The principles set out in subregulation (2)(b)(ii) only apply if the Technical Regulator has given approval to the electricity entity or council to keep vegetation clear of the powerlines in accordance with those principles.
- (5) If an electricity entity has the duty to keep vegetation clear of the powerlines—
- (a) the entity must not, in clearing vegetation in accordance with the principles set out in subregulation (2)(a), clear vegetation from around an overhead powerline—
 - (i) more than is reasonably necessary to satisfy those principles; or
 - (ii) if there is a buffer zone around the powerline, beyond the buffer zone, except if—
 - (iii) it is reasonably necessary to do so for the purposes of enhancing the appearance and ensuring the stability and health of remaining vegetation (but in that case, if there is a buffer zone around the powerline, the vegetation must not be cleared beyond the buffer zone); or
 - (iv) the entity agrees, at the request of the occupier of the land on which the vegetation is situated, to undertake the clearance and the clearance would not be contrary to the provisions of any other law if carried out by the occupier; and
 - (b) the entity must not, in clearing vegetation in accordance with the principles set out in subregulation (2)(b)(ii), clear more vegetation than it could by clearing in accordance with the principles set out in subregulation (2)(a).
- (6) If a council has the duty to keep vegetation clear of the powerlines, the council need not, in clearing vegetation in accordance with the principles set out in subregulation (2)(b)(ii), clear more vegetation than would be reasonably necessary to satisfy the principles set out in subregulation (2)(a).

5—Duty of occupier

- (1) The principles of vegetation clearance set out in this regulation are prescribed for the purposes of Part 5 of the Act and govern the duty of an occupier of private land to take reasonable steps to keep vegetation clear of private powerlines on the land.
- (2) An occupier of private land must keep vegetation (other than naturally occurring vegetation) clear of any private overhead powerline on that land so that—
 - (a) no part of the vegetation at any time intrudes into the clearance zone around that powerline in still air; and
 - (b) no part of the vegetation is at any time likely to bend into that zone in winds that might reasonably be expected in the area.
- (3) An occupier of private land is not required to clear vegetation beyond the buffer zone around any powerline.
- (4) An occupier of private land must not clear vegetation which the occupier may not lawfully clear apart from this regulation—
 - (a) more than is reasonably necessary to satisfy the requirements of subregulation (2) and for the purposes of enhancing the appearance and ensuring the stability and health of any remaining vegetation; or
 - (b) if there is a buffer zone around the powerline, beyond the buffer zone.

6—Planting and nurturing vegetation near powerlines

For the purposes of Part 5 of the Act, Schedule 2 sets out requirements for planting or nurturing vegetation near powerlines.

7—Technical Regulator may grant exemption from principles of vegetation clearance

- (1) The Technical Regulator may, on application—
 - (a) exempt an occupier of land on which vegetation is planted or nurtured for commercial purposes (not including the production of timber) from compliance with regulation 5; or
 - (b) exempt a person from compliance with a provision of Schedule 2 in relation to specified vegetation.
- (2) An application under this regulation must—
 - (a) be made in a form approved by the Technical Regulator; and
 - (b) contain the information specified in the form; and
 - (c) be accompanied by an application fee fixed by the Minister.
- (3) Before determining an application under this regulation, the Technical Regulator must give the electricity entity or council with the duty to keep the vegetation clear of powerlines a reasonable opportunity to make submissions and be heard on the matter.
- (4) An exemption under this regulation—
 - (a) must be in writing; and
 - (b) may be subject to conditions, including a condition that the applicant is to pay any costs that the electricity entity or council incur in keeping the vegetation clear of powerlines in accordance with these regulations.

- (5) A person who contravenes, or fails to comply with, a condition of an exemption under this regulation is guilty of an offence.
- Maximum penalty: \$5 000.
- Expiation fee: \$315.

8—Vegetation clearance scheme outside prescribed areas agreed between council and electricity entity

- (1) This regulation applies to public land in a non-bushfire risk area but not within a prescribed area.
- (2) An electricity entity may agree a vegetation clearance scheme with a council governing the way in which the entity will carry out its duty to clear vegetation in the area of the council or part of that area.
- (3) The factors that should be taken into consideration in formulating a scheme include the following:
- (a) the nature of the vegetation, including its expected rate of growth;
 - (b) the impact that the clearance work would be likely to have on the amenity of the area;
 - (c) the historical or biological significance (if any) of the vegetation;
 - (d) the long term effect that the clearance work would be likely to have on the health and appearance of the vegetation;
 - (e) the controls on the planting and nurturing of vegetation applicable in the area;
 - (f) the need to prevent damage to the powerlines and interruption to the supply of electricity and to safeguard the public against electric shock and damage to property;
 - (g) the extent and frequency of past vegetation clearance in the area;
 - (h) whether requirements with respect to vegetation clearance and the planting and nurturing of vegetation have been complied with in the area and, if not, the reasons for the non-compliance;
 - (i) the existence and terms of other vegetation clearance schemes;
 - (j) any proposal to alter, remove or underground powerlines in the area;
 - (k) the costs of the proposals (including insurance premiums) to the council and to the electricity entity and the financial resources of the council and entity;
 - (l) the limits on the financial and other resources of the electricity entity that may be devoted to the scheme and the schemes for the areas of other councils;
 - (m) any arrangement between the electricity entity and the council conferring on the council a specified role in relation to vegetation clearance.
- (4) A scheme cannot derogate from the principles set out in regulation 4.
- (5) A scheme—
- (a) must be in writing and executed by the council and the electricity entity (however, separate execution is not required if the scheme is combined with an arrangement under Part 5 of the Act conferring on the council a specified role in relation to vegetation clearance); and

- (b) may be varied or revoked by written agreement between the parties.
- (6) A vegetation clearance scheme as agreed has effect, and may be enforced, as a contract between the electricity entity and the council concerned.

9—Agreement between occupier and electricity entity

- (1) An electricity entity may enter into an agreement with an occupier of private land under which—
 - (a) vegetation around powerlines in a specified area of the land is to be inspected and cleared more frequently than required under regulation 4; or
 - (b) the occupier undertakes to carry out the required inspection and clearance of vegetation on that land on behalf of the entity.
- (2) The agreement—
 - (a) must be in writing and executed by the occupier and the electricity entity; and
 - (b) must specify—
 - (i) the area concerned; and
 - (ii) the intervals at which inspection and clearance must be carried out; and
 - (iii) unless the occupier undertakes to carry out the inspections and clearance on behalf of the electricity entity—the payments agreed between the parties in respect of the costs of the additional work required under the agreement; and
 - (c) may be varied or revoked by further written agreement between the parties; and
 - (d) has effect, and may be enforced, as a contract between the electricity entity and the occupier.

10—Objections relating to vegetation clearance

- (1) An occupier or owner of private land may lodge an objection with the Technical Regulator concerning a matter set out in a notice of intention to enter land to carry out work received from an electricity entity or council under Part 5 of the Act.
- (2) An objection under this regulation must—
 - (a) be made to the Technical Regulator in writing; and
 - (b) be lodged with the Technical Regulator within 21 days after receipt of the notice to which the objection relates or such further time as the Technical Regulator allows.
- (3) The Technical Regulator must, on receipt of an objection, notify the electricity entity or council, as the case may require, of the objection.
- (4) On receiving notification of the objection, the electricity entity or council is prohibited from carrying out the clearance of vegetation to which the objection relates until the objection has been determined by the Technical Regulator.
- (5) The Technical Regulator may—
 - (a) dismiss the objection; or
 - (b) direct the electricity entity or council to take or to refrain from taking any specified action in relation to the matter; or

- (c) if the objector and the electricity entity or council have reached an agreement as to how the objection might be resolved, and the agreement does not involve a breach of these regulations—determine the objection so as to reflect the agreement.
- (6) The Technical Regulator may dismiss the objection—
 - (a) on the ground that—
 - (i) the subject matter of the objection is substantially the same as the subject matter of an objection previously considered; or
 - (ii) the objection is frivolous or vexatious or without reasonable basis; or
 - (iii) the objector has not made a reasonable attempt to resolve the matter by agreement with the electricity entity or council; or
 - (b) if satisfied that the objector and the electricity entity or council have entered into an agreement under regulation 9 that relates to the subject matter of the objection; or
 - (c) if satisfied for any other reason that the objection should not be allowed.
- (7) The Technical Regulator must, as soon as practicable, notify the objector and the electricity entity or council, as the case may require, of the Technical Regulator's determination of the objection.
- (8) An electricity entity or council must, when giving notice of an intention to enter private land to carry out work under Part 5 of the Act, include in or with the notice a statement of the rights of the owner or occupier to lodge an objection under this regulation.

11—Notification of clearance by electricity entity to council

- (1) An electricity entity must give a council not less than 30 days written notice before commencing a program of vegetation clearance in the area of the council, including details of when and where clearance is to take place under the program.
- (2) Subregulation (1) does not apply if the clearance work to be carried out is subject to a vegetation clearance scheme.

Schedule 1—Clearance and buffer zones around overhead powerlines

1—Legend for diagrams

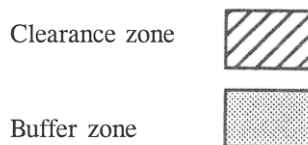

2—Clearance zone around overhead powerlines on public land in a non-bushfire risk area

- (1) **Diagram A—public land in non-bushfire risk area—fully insulated or low voltage**
 This diagram applies to a powerline that has conductors which are fully insulated (eg aerial bundled cables) or low voltage conductors.
 The clearance zone as shown extends along the length of each span of the powerline.

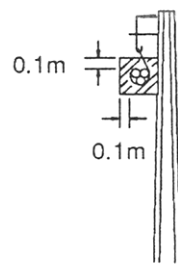
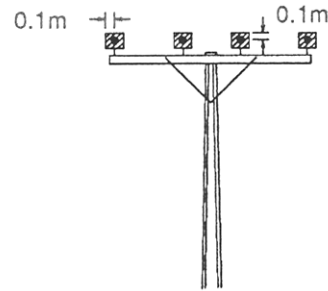
FULLY INSULATEDBARE LOW VOLTAGE

0.1m dimension is from conductor positions in still air.

(2) **Diagram B—public land in non-bushfire risk area—insulated unscreened**

This diagram applies to a powerline the conductors of which are Insulated Unscreened Conductor ("IUC" or "CCT").

The clearance zone as shown extends along the length of each span of the powerline.

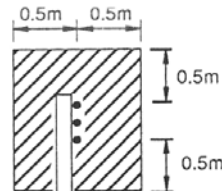
INSULATED UNSCREENED CONDUCTORS

0.5m dimension is from conductor positions in still air.

(3) **Diagram C—public land in non-bushfire risk area—not insulated more than 480V but less than 33kV**

These diagrams apply to a powerline, the conductors of which are not insulated, constructed to operate at a voltage of more than 480V but less than 33kV.

Diagram C.1 shows the clearance zone at the pole or other support at the end of each span of the powerline.

Diagram C.2 shows the clearance zone at mid span (as shown in diagrams C.3 & C.4) for each span of the powerline.

Diagrams C.3 and C.4 show the manner in which the clearance zone extends along the length of each span of the powerline.

The values of P, V and H are set out in Tables 1 and 2 in clause 5.

C.1—public land in non-bushfire risk area—not insulated more than 480V but less than 33kV—at each end of span

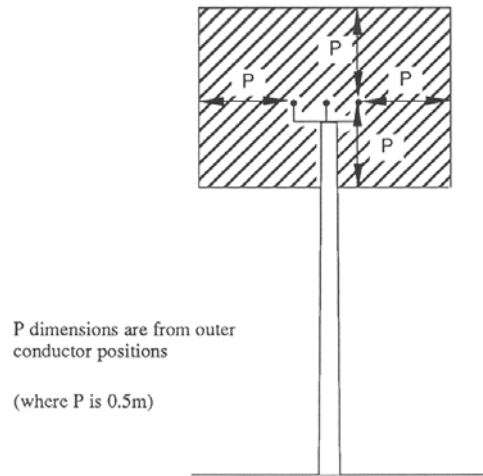

C.2—public land in non-bushfire risk area—not insulated more than 480V but less than 33kV—mid span (as shown in diagrams C.3 and C.4)

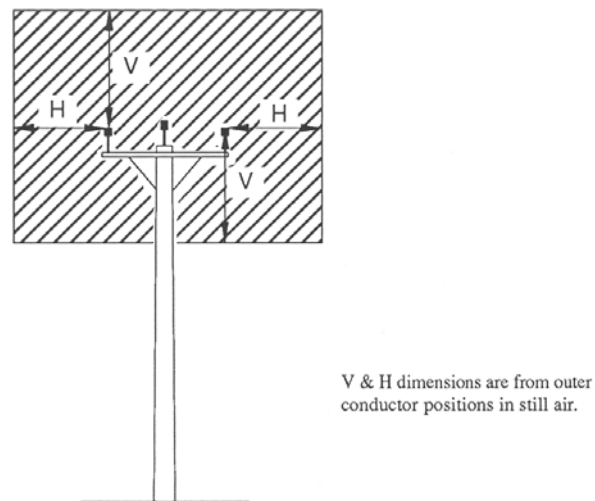

C.3—public land in non-bushfire risk area—not insulated more than 480V but less than 33kV—view of clearance zone from above

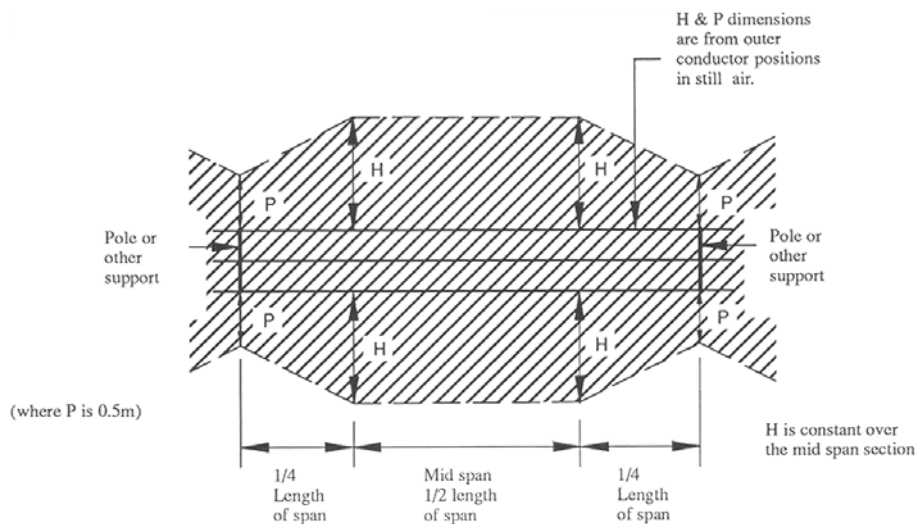

C.4—public land in non-bushfire risk area—not insulated more than 480V but less than 33kV—view of clearance zone from side

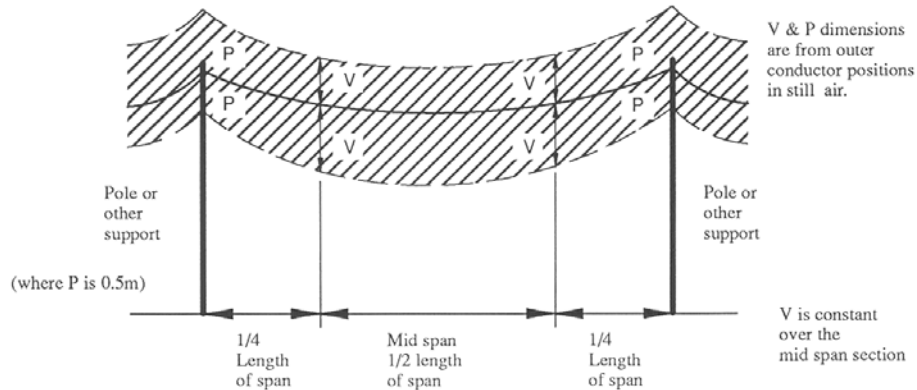

(4) Diagram D—public land in non-bushfire risk area—not insulated 33kV to 66kV

These diagrams apply to a powerline, the conductors of which are not insulated, constructed to operate at a voltage from 33kV to 66kV inclusive.

Diagram D.1 shows the clearance zone at the pole or other support at the end of each span of the powerline.

Diagram D.2 shows the clearance zone at mid span (as shown in diagrams D.3 and D.4) for each span of the powerline.

Diagrams D.3 and D.4 show the manner in which the clearance zone extends along the length of each span of the powerline.

The values of V, H and P are set out in Table 3 in clause 5.

D.1—public land in non-bushfire risk area—not insulated 33kV to 66kV—at each end of a span

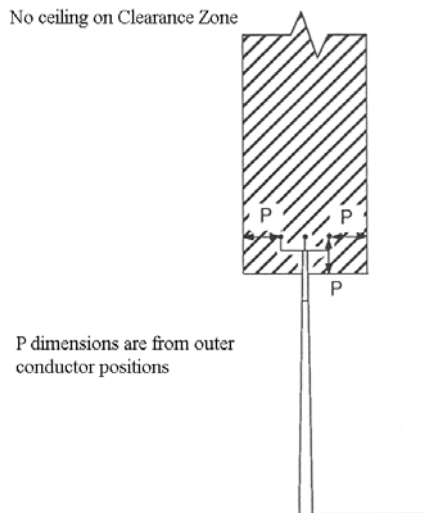

**D.2—public land in non-bushfire risk area—not insulated 33kV to 66kV—mid span
(as shown in diagrams D.3 and D.4)**

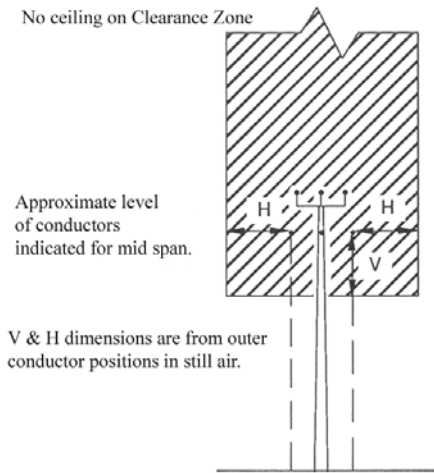

**D.3—public land in non-bushfire risk area—not insulated 33kV to 66kV—view of
clearance zone from above**

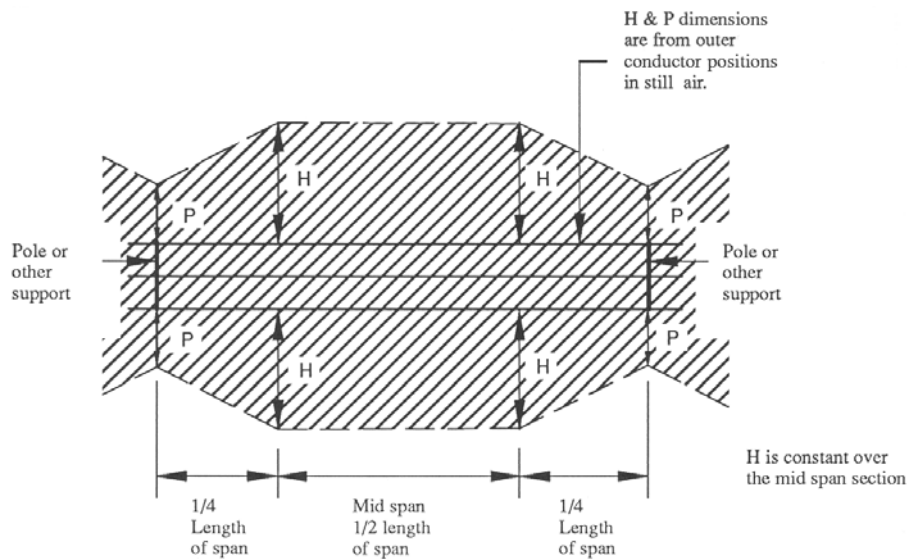

**D.4—public land in non-bushfire risk area—not insulated 33kV to 66kV—view of
clearance zone from side**

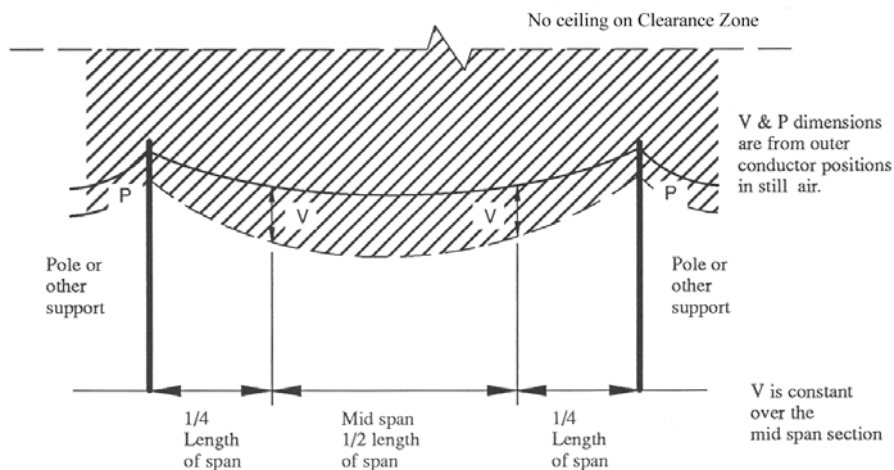

(5) **Diagram E—public land in non-bushfire risk area—not insulated 132kV to 275kV**

These diagrams apply to a powerline, the conductors of which are not insulated, constructed to operate at a voltage from 132kV to 275kV inclusive.

Diagram E.1 shows the clearance zone at the pole or other support at the end of each span of the powerline.

Diagram E.2 shows the clearance zone at mid span (as shown in diagrams E.3 and E.4) for each span of the powerline.

Diagrams E.3 and E.4 show the manner in which the clearance zone extends along the length of each span of the powerline.

The values of V, H, S and P are set out in Table 4 in clause 5.

The 45° component of the clearance zone is determined as being 3 m from the 45° cutoff line.

E.1—public land in non-bushfire risk area—not insulated 132kV to 275kV—at each end of a span

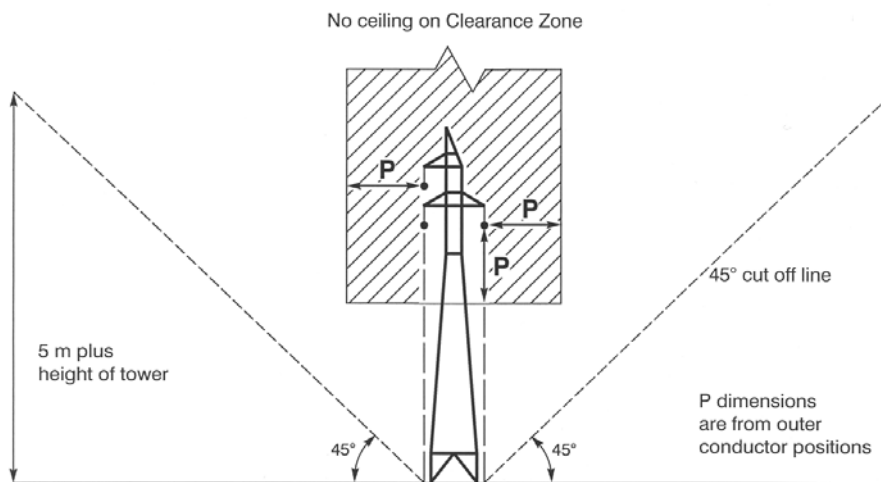

E.2—public land in non-bushfire risk area—not insulated 132kV to 275kV—mid span (as shown in diagrams E.3 and E.4)

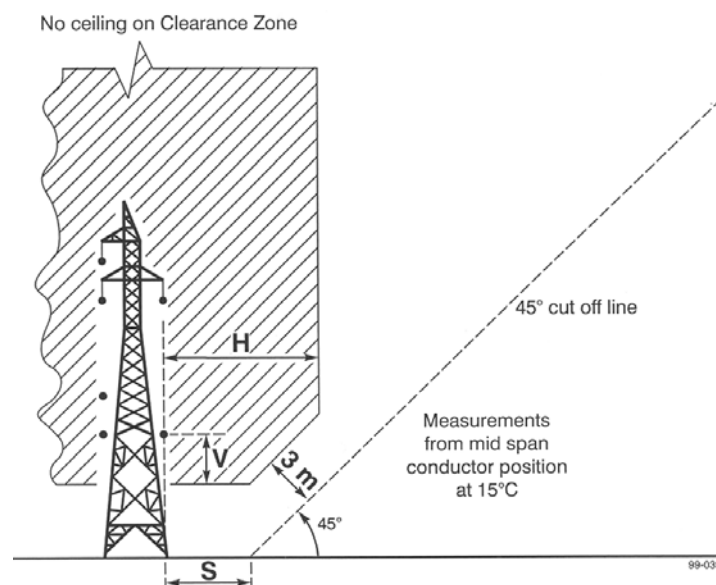

E.3—public land in non-bushfire risk area—not insulated 132kV to 275kV—view of clearance zone from above

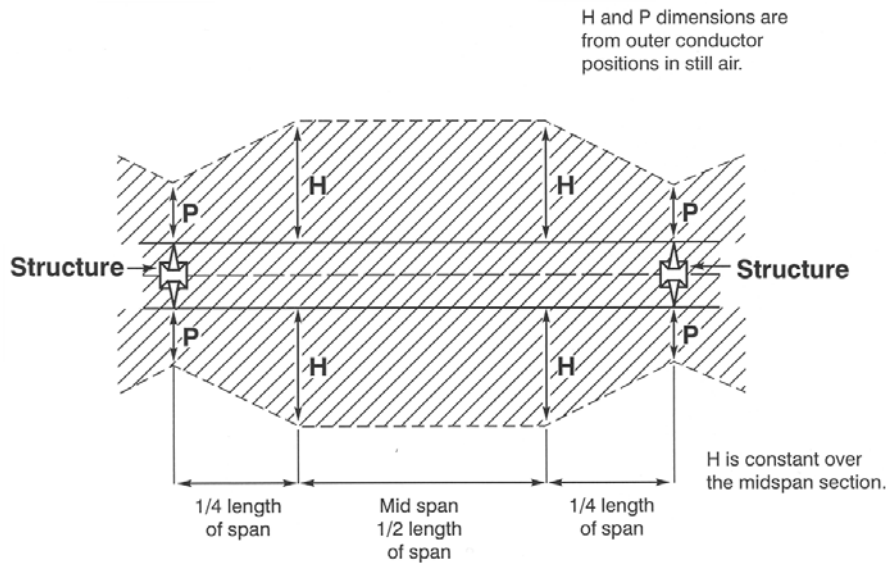

E.4—public land in non-bushfire risk area—not insulated 132kV to 275kV—view of clearance zone from side

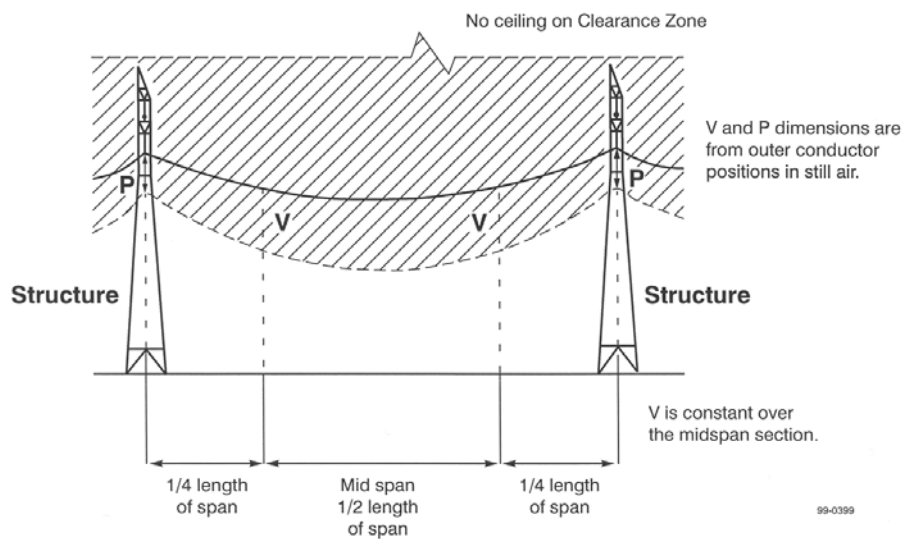

3—Clearance and buffer zones around overhead powerlines on private land in a non-bushfire risk area

(1) **Diagram A—private land in non-bushfire risk area—fully insulated or low voltage**

This diagram applies to a powerline that has conductors which are fully insulated (eg aerial bundled cables) or low voltage conductors.

The zones as shown extend along the length of each span of the powerline.

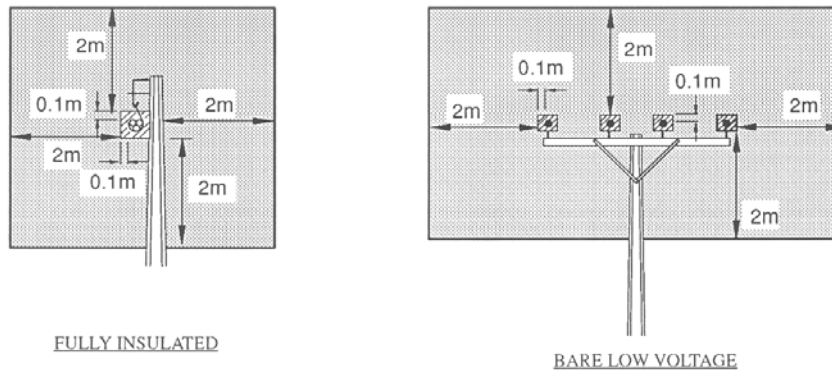

0.1 m dimension is from conductor positions in still air.

(2) **Diagram B—private land in non-bushfire risk area—insulated unscreened**

This diagram applies to a powerline the conductors of which are Insulated Unscreened Conductor ("IUC" or "CCT").

The zones as shown extend along the length of each span of the powerline.

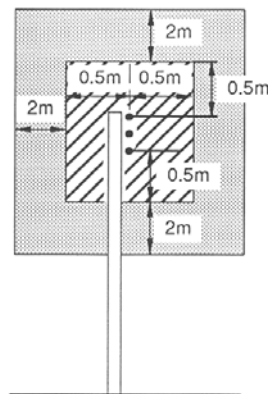

INSULATED UNSCREENED CONDUCTORS

0.5 m dimension is from conductor positions in still air.

(3) **Diagram C—private land in non-bushfire risk area—not insulated more than 480V but less than 33kV**

These diagrams apply to a powerline the conductors of which are not insulated, constructed to operate at a voltage of more than 480V but less than 33kV.

Diagram C.1 shows the zones at the pole or other support at the end of each span of the powerline.

Diagram C.2 shows the clearance zone at mid span (as shown in diagrams C.3 and C.4) for each span of the powerline.

Diagrams C.3 and C.4 show the manner in which the clearance zone extends along the length of each span of the powerline.

Although not shown in diagrams C.3 and C.4, the buffer zone as shown in diagrams C.1 and C.2 extends along the length of each span of the powerline.

The values of P, V and H are set out in Tables 1 and 2 in clause 5.

C.1—private land in non-bushfire risk area—not insulated more than 480V but less than 33kV—at each end of a span

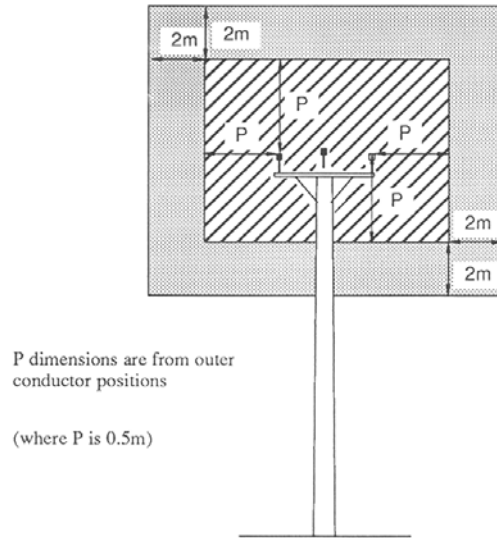

C.2—private land in non-bushfire risk area—not insulated more than 480V but less than 33kV—mid span (as shown in diagrams C.3 and C.4)

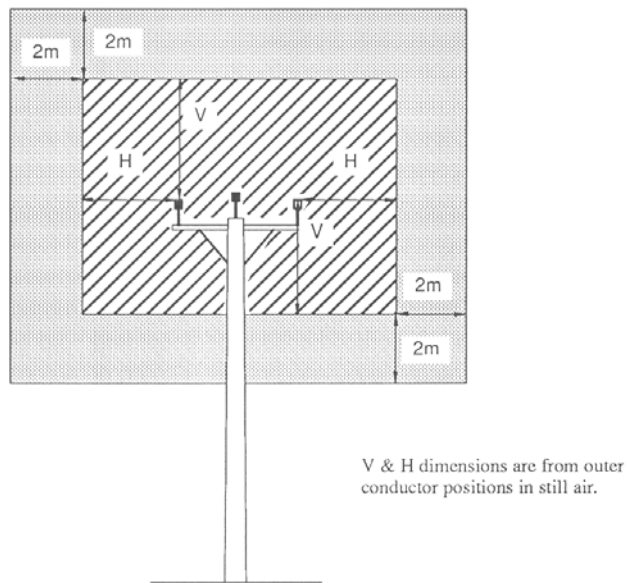

C.3—private land in non-bushfire risk area—not insulated more than 480V but less than 33kV—view of clearance zone from above

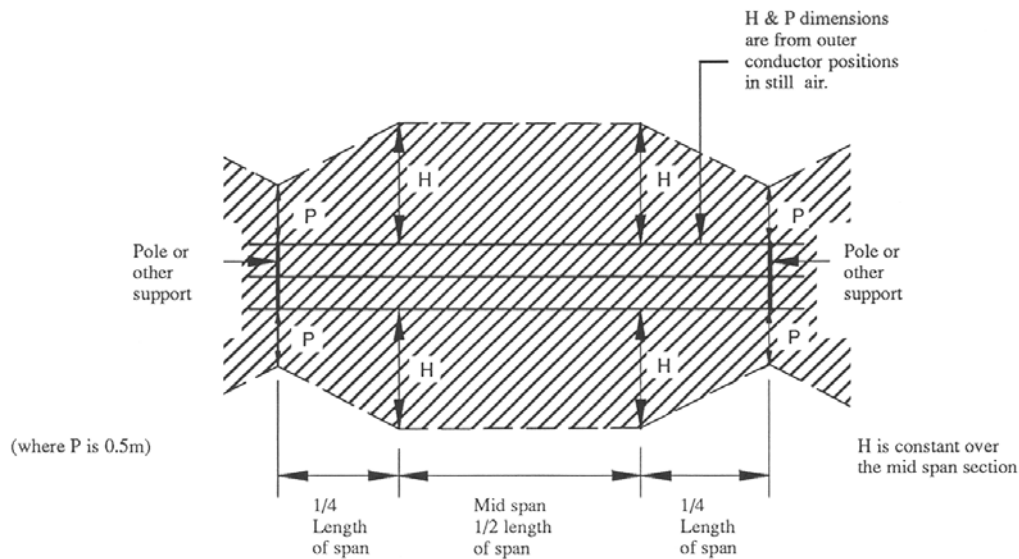

C.4—private land in non-bushfire risk area—not insulated more than 480V but less than 33kV—view of clearance zone from side

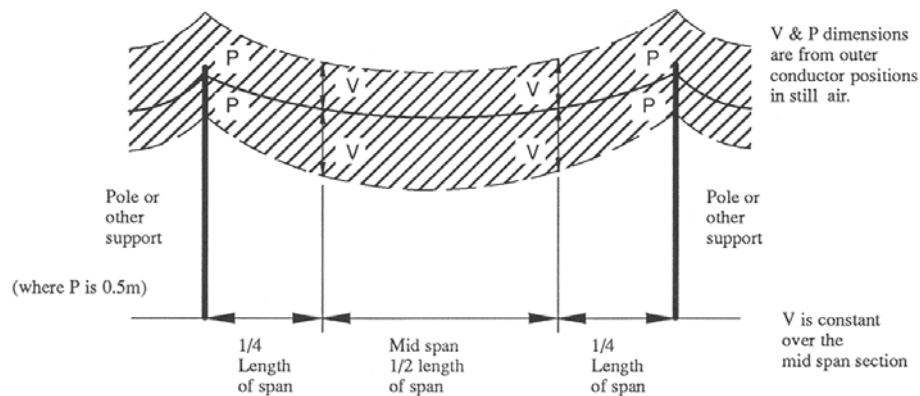

(4) Diagram D—private land in non-bushfire risk area—not insulated 33kV to 66kV

These diagrams apply to a powerline, the conductors of which are not insulated, constructed to operate at a voltage from 33kV to 66kV inclusive.

Diagram D.1 shows the zones at the pole or other support at the end of each span of the powerline.

Diagram D.2 shows the zones at mid span (as shown in diagrams D.3 and D.4) for each span of the powerline.

Diagrams D.3 and D.4 show the manner in which the clearance zone extends along the length of each span of the powerline.

Although not shown in diagrams D.3 and D.4, the buffer zone as shown in diagrams D.1 and D.2 extends along the length of each span of the powerline.

The values of V, H, B and P are set out in Table 3 in clause 5.

D.1—private land in non-bushfire risk area—not insulated 33kV to 66kV—at each end of a span

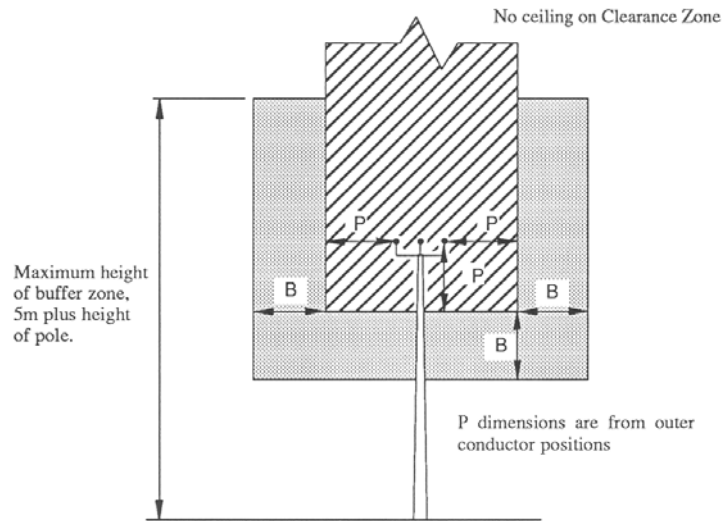

D.2—private land in non-bushfire risk area—not insulated 33kV to 66kV—mid span (as shown in diagrams D.3 and D.4)

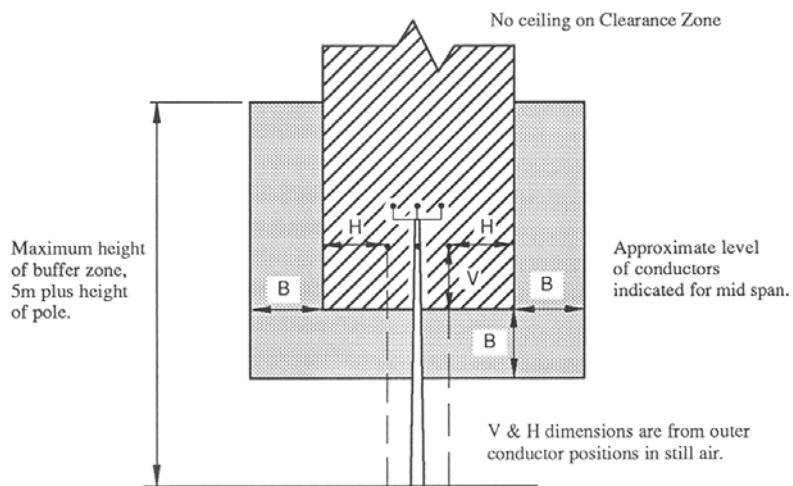

D.3—private land in non-bushfire risk area—not insulated 33kV to 66kV—view of clearance zone from above

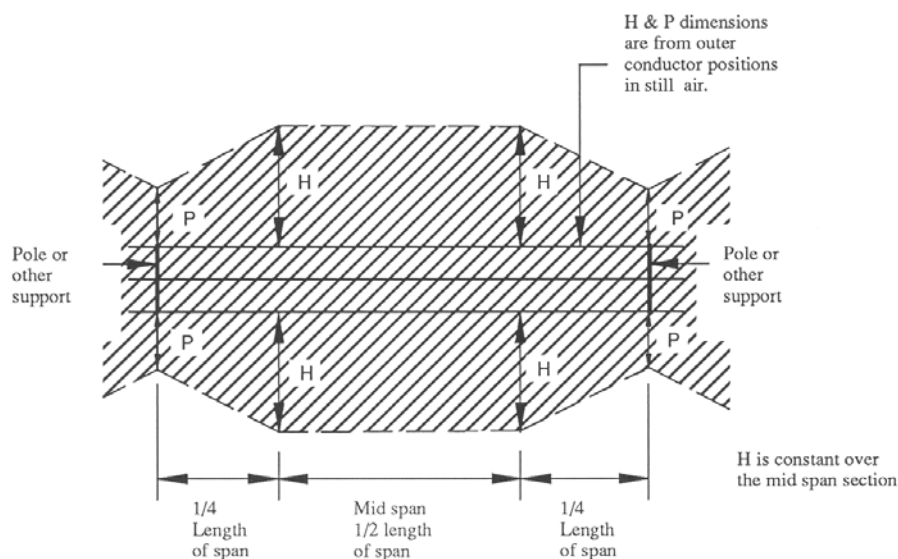

D.4—private land in non-bushfire risk area—not insulated 33kV to 66kV—view of clearance zone from side

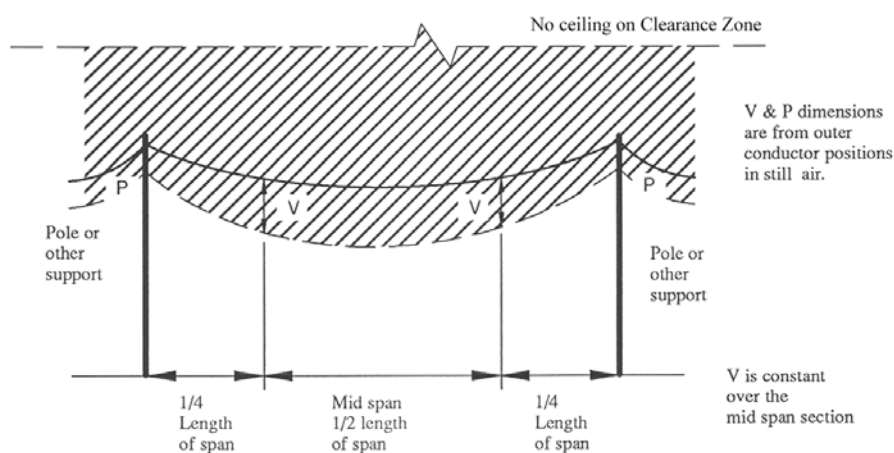

(5) **Diagram E—private land in non-bushfire risk area—not insulated 132kV to 275kV**

These diagrams apply to a powerline, the conductors of which are not insulated, constructed to operate at a voltage from 132kV to 275kV inclusive.

Diagram E.1 shows the zones at the pole or other support at the end of each span of the powerline.

Diagram E.2 shows the zones at mid span (as shown in diagrams E.3 and E.4) for each span of the powerline.

Diagrams E.3 and E.4 show the manner in which the clearance zone extends along the length of each span of the powerline.

Although not shown in diagrams E.3 and E.4, the buffer zone as shown in diagrams E.1 and E.2 extends along the length of each span of the powerline.

The values of V, H, S, B and P are set out in Table 4 in clause 5.

The 45° component of the clearance zone is determined as being 3 m inside the buffer zone.

E.1—private land in non-bushfire risk area—not insulated 132kV to 275kV—at each end of a span

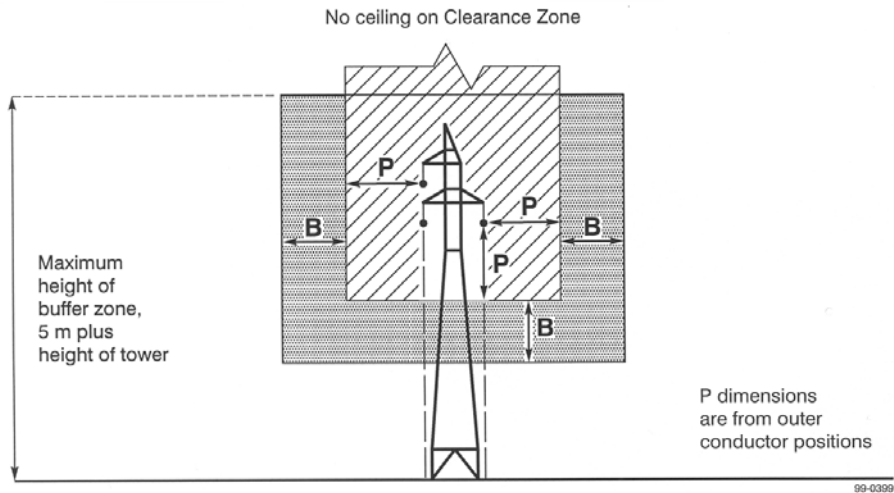

E.2—private land in non-bushfire risk area—not insulated 132kV to 275kV—mid span (as shown in diagrams E.3 and E.4)

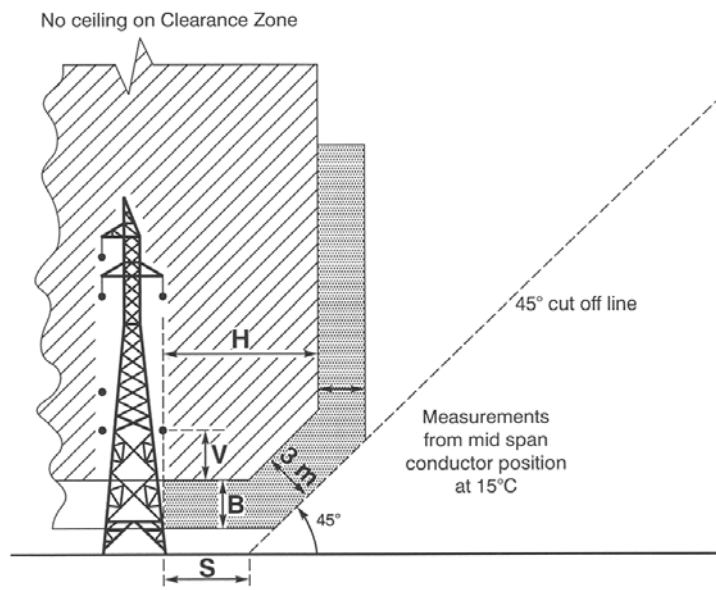

E.3—private land in non-bushfire risk area—not insulated 132kV to 275kV—view of clearance zone from above

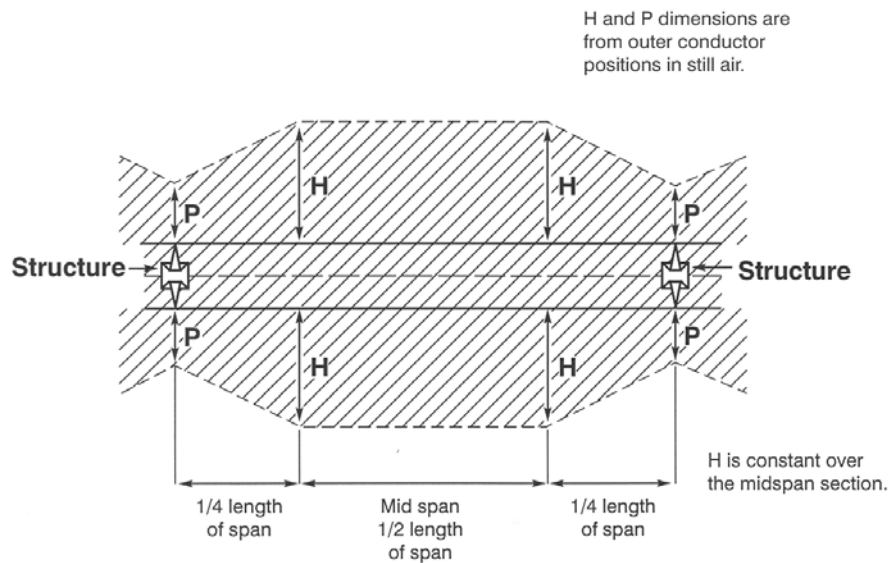

E.4—private land in non-bushfire risk area—not insulated 132kV to 275kV—view of clearance zone from side

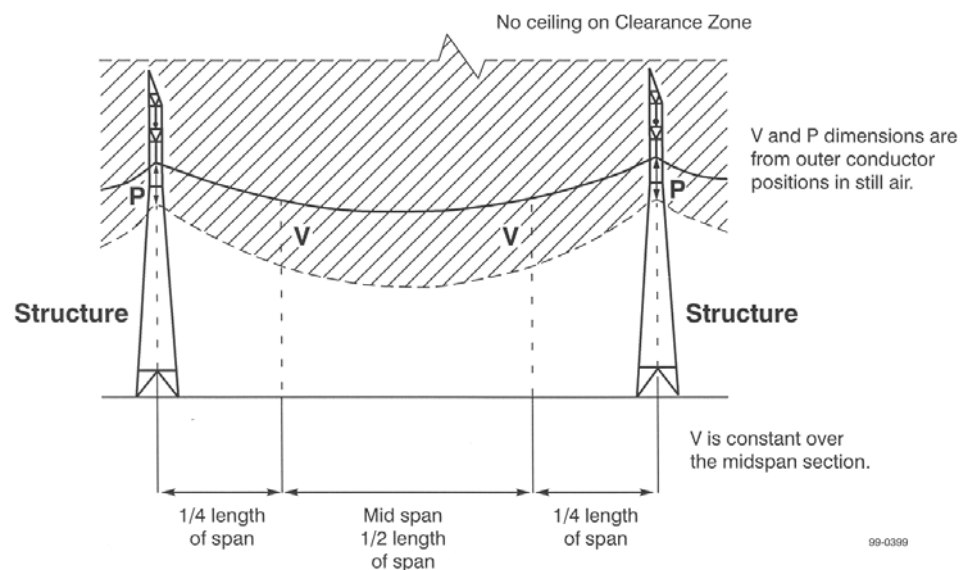

4—Clearance and buffer zones around overhead powerlines in the bushfire risk area

(1) **Diagram A—bushfire risk area—fully insulated**

This diagram applies to a powerline the conductors of which are fully insulated (eg aerial bundled cables).

The zones as shown extend along the length of each span of the powerline.

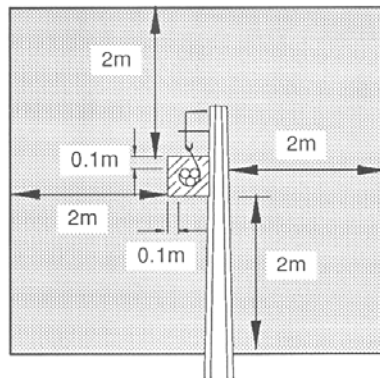
FULLY INSULATED

0.1 m dimension is from conductor position in still air.

(2) **Diagram B—bushfire risk area—insulated unscreened**

This diagram applies to a powerline the conductors of which are Insulated Unscreened Conductor ("IUC" or "CCT").

The zones as shown extend along the length of each span of the powerline.

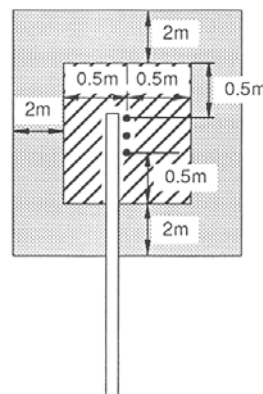
INSULATED UNSCREENED CONDUCTORS

0.5 m dimension is from conductor positions in still air.

(3) **Diagram C—bushfire risk area—not insulated less than 33kV**

These diagrams apply to a powerline, the conductors of which are not insulated, constructed to operate at a voltage of less than 33kV.

Diagram C.1 shows the zones at the pole or other support at the end of each span of the powerline.

Diagram C.2 shows the zones at mid span (as shown in diagrams C.3 and C.4) for each span of the powerline.

Diagrams C.3 and C.4 show the manner in which the clearance zone extends along the length of each span of the powerline.

Although not shown in diagrams C.3 and C.4, the buffer zone as shown in diagrams C.1 and C.2 extends along the length of each span of the powerline.

The values of V, H and P are set out in Tables 1 and 2 in clause 5.

C.1—bushfire risk area—not insulated less than 33kV—at each end of a span

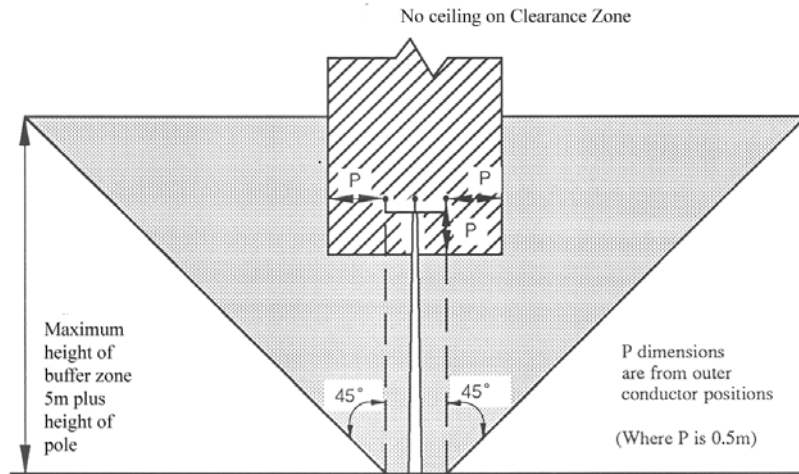

C.2—bushfire risk area—not insulated less than 33kV—mid span (as shown in diagrams C.3 and C.4)

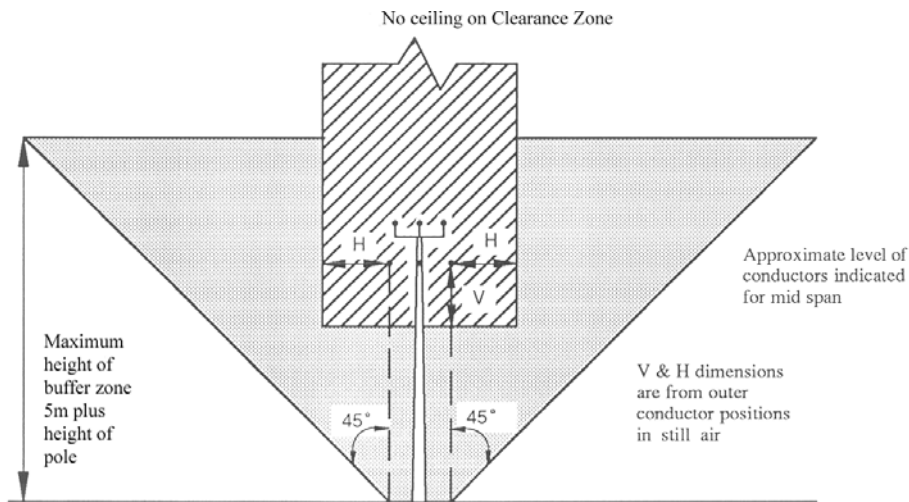

C.3—bushfire risk area—not insulated less than 33kV—view of clearance zone from above

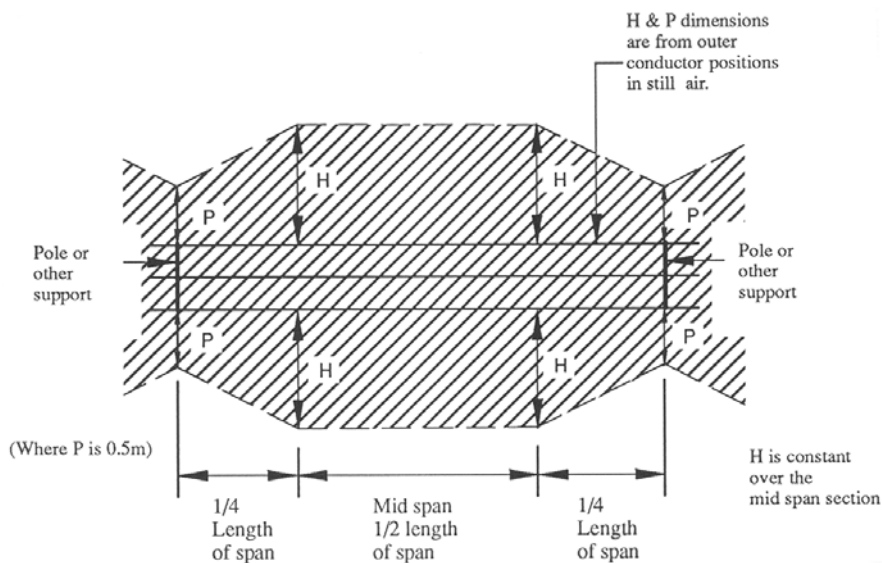

C.4—bushfire risk area—not insulated less than 33kV—view of clearance zone from side

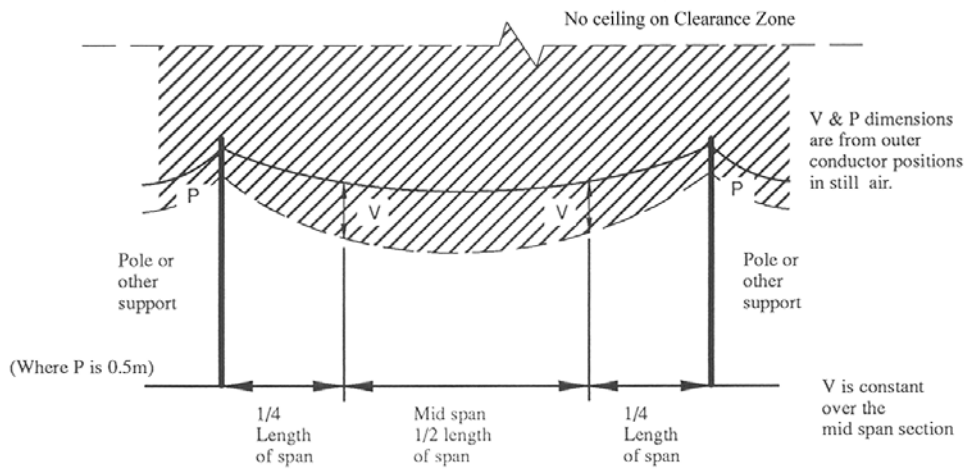

(4) Diagram D—bushfire risk area—not insulated 33kV to 66kV

These diagrams apply to a powerline, the conductors of which are not insulated, constructed to operate at a voltage from 33kV to 66kV inclusive.

Diagram D.1 shows the zones at the pole or other support at the end of each span of the powerline.

Diagram D.2 shows the zones at mid span (as shown in diagrams D.3 and D.4) for each span of the powerline.

Diagrams D.3 and D.4 show the manner in which the clearance zone extends along the length of each span of the powerline.

Although not shown in diagrams D.3 and D.4, the buffer zone as shown in diagrams D.1 and D.2 extends along the length of each span of the powerline.

The values of V, H and P are set out in Table 3 in clause 5.

D.1—bushfire risk area—not insulated 33kV to 66kV—at each end of a span

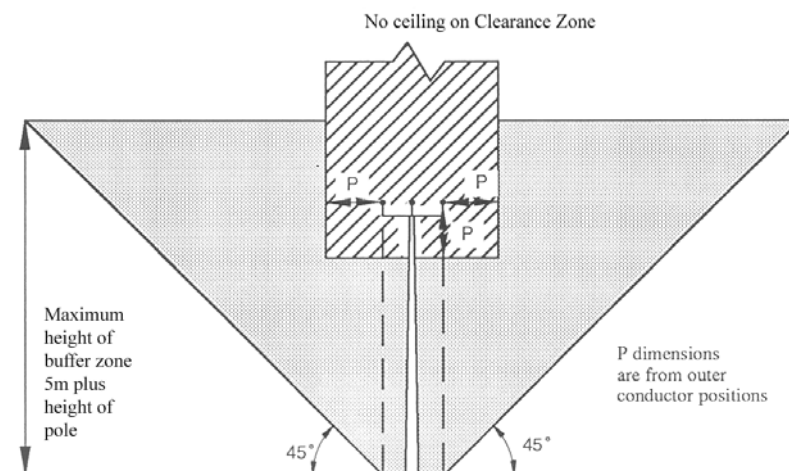

D.2—bushfire risk area—not insulated 33kV to 66kV—mid span (as shown in diagrams D.3 and D.4)

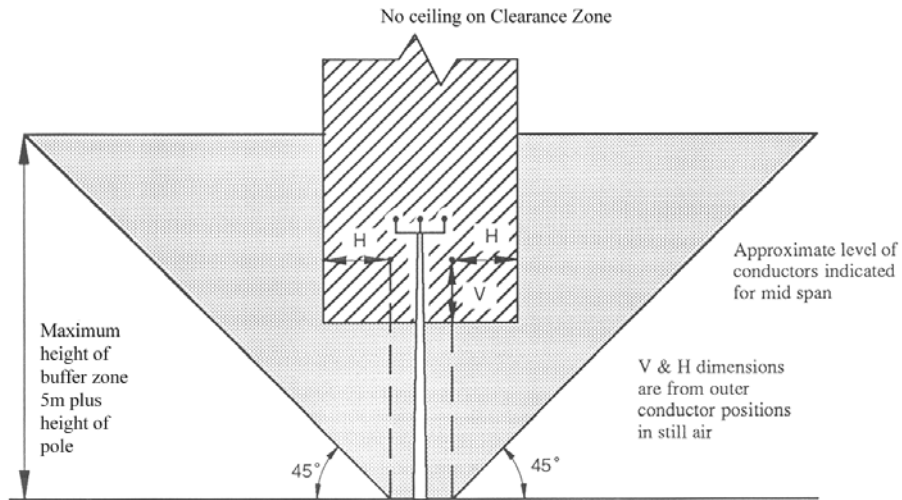

D.3—bushfire risk area—not insulated 33kV to 66kV—view of clearance zone from above

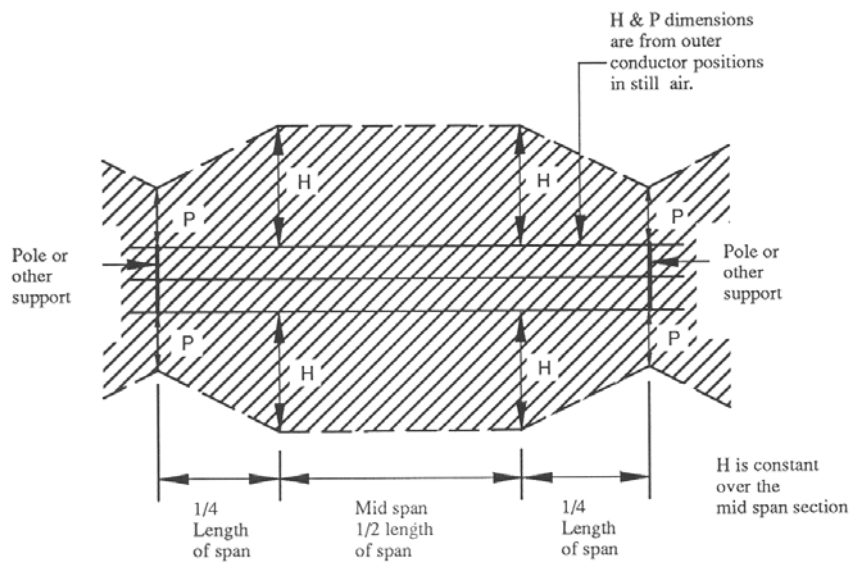

D.4—bushfire risk area—not insulated 33kV to 66kV—view of clearance zone from side

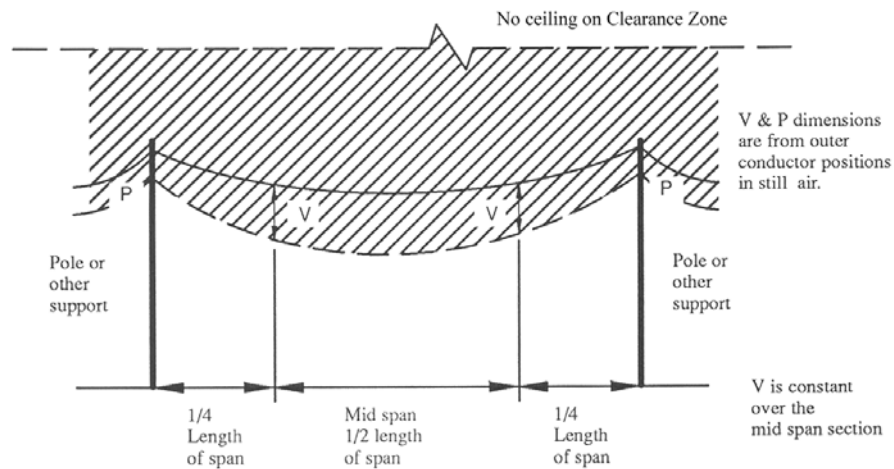

(5) **Diagram E—bushfire risk area—not insulated 132kV to 275kV**

These diagrams apply to a powerline, the conductors of which are not insulated, constructed to operate at a voltage from 132kV to 275kV inclusive.

Diagram E.1 shows the zones at the pole or other support at the end of each span of the powerline.

Diagram E.2 shows the zones at mid span (as shown in diagrams E.3 and E.4) for each span of the powerline.

Diagrams E.3 and E.4 show the manner in which the clearance zone extends along the length of each span of the powerline.

Although not shown in diagrams E.3 and E.4, the buffer zone as shown in diagrams E.1 and E.2 extends along the length of each span of the powerline.

The values of V, H, S, B and P are set out in Table 4 in clause 5.

The 45° component of the clearance zone is determined as being 3 m inside the buffer zone.

E.1—bushfire risk area—not insulated 132kV to 275kV—at each end of a span

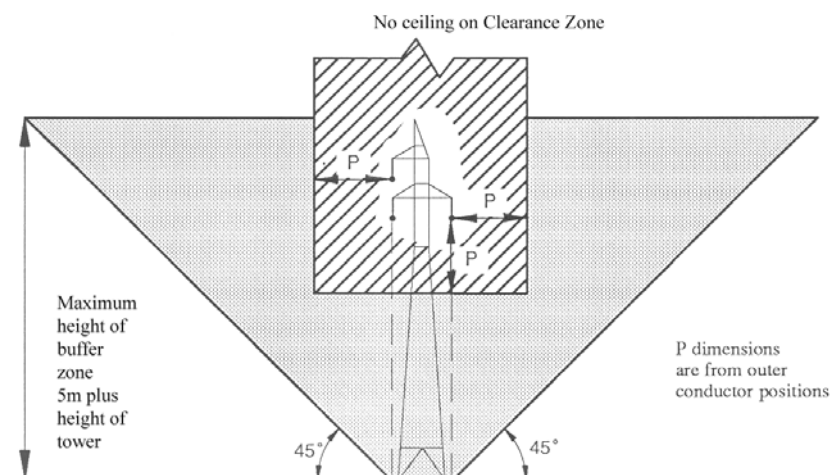

E.2—bushfire risk area—not insulated 132kV to 275kV—mid span (as shown in diagrams E.3 and E.4)

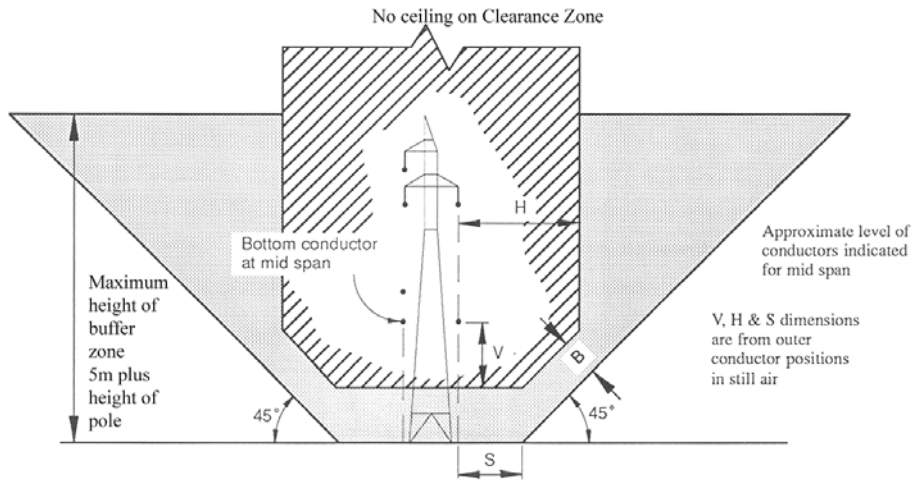

E.3—bushfire risk area—not insulated 132kV to 275kV—view of clearance zone from above

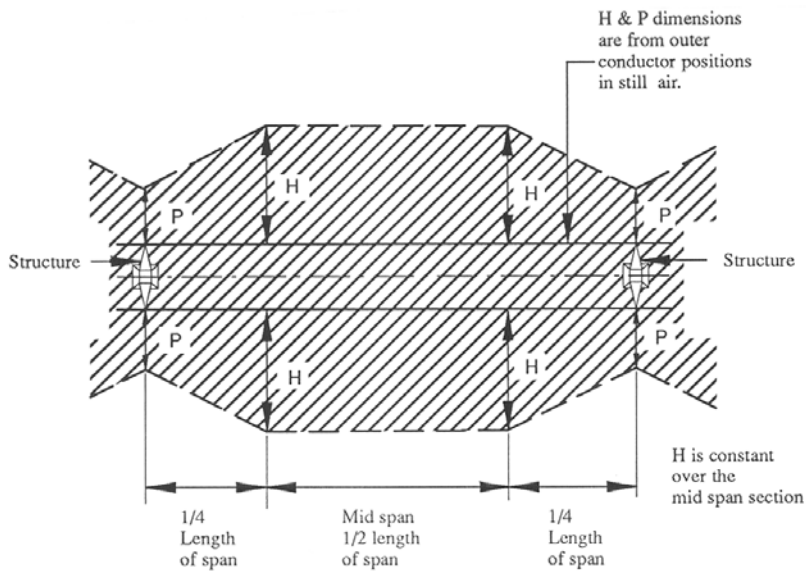

E.4—bushfire risk area—not insulated 132kV to 275kV—view of clearance zone from side

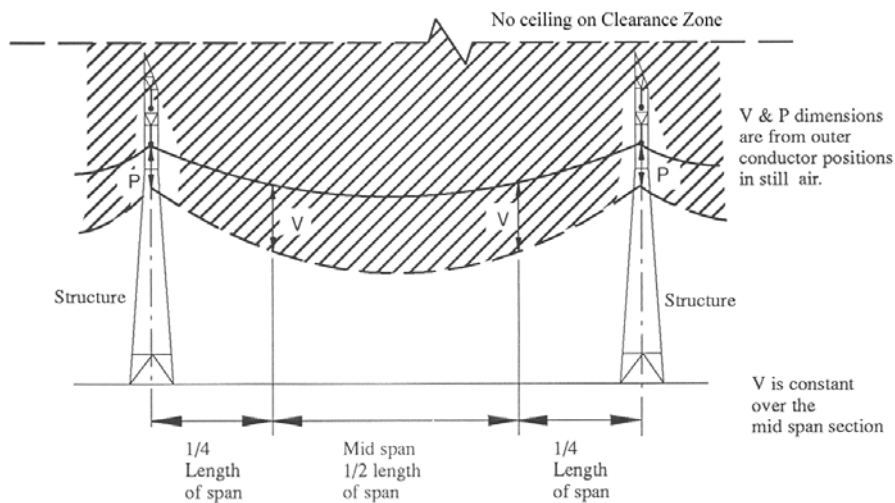

5—Tables for determination of value of V, H, B, S and P

- (1) The values of V, H, B, S and P are determined by the voltage at which the powerline is constructed to operate and the length of the span concerned.
- (2) For 132kV and 275kV lines, a "stepout" S is required for the buffer zone.
- (3) For the purposes of compliance with the requirements of these regulations as to clearance of vegetation from around powerlines, as an alternative, the value of S may be taken to be that fixed for S* in Table 4—
 - (a) until 31 October 2010; and
 - (b) after that date, provided that the clearance zone will still extend at least—
 - (i) in the case of a 132kV line—1.5 m; or
 - (ii) in the case of a 275kV line—2.5 m,
 beyond any point to which the line may swing or sag at a wind pressure of 400Pa (taking into account the length of the span concerned and the characteristics of the line).
- (4) The values given are in metres.
- (5) The clearance to uninsulated LV conductors in non-bushfire risk areas is 0.1 m for the length of the line and beyond termination poles or structures, as is also the case for fully insulated conductors in any part of the State.
- (6) The value of P determines the clearances required beyond a pole where a line terminates, in addition to clearances at poles or other supports along the length of the powerline.
- (7) A buffer zone of 1 m and no clearance zone applies where a neutral conductor (CMEN) is not within the clearance zone or buffer zone of an adjoining conductor.
- (8) The clearance to Insulated Unscreened Conductor ("IUC" or "CCT") is 0.5 m for the length of the line and beyond termination poles or structures, in any part of the State.

Table 1—Bare or covered conductor at operating voltages of 240V to 11kV

Voltage	All spans	Span (in metres)									
		0–50		Over 50–100		Over 100–150		Over 150–200		Over 200	
	P	V	H	V	H	V	H	V	H	V	H
Voltage not exceeding 480V in bushfire risk areas only	0.5	1.0	1.0	1.5	2.5	1.5	3.5	—	—	—	—
7.6kV and 11kV in bushfire and non-bushfire risk areas	0.5	1.5	1.5	2.0	2.5	2.5	3.5	2.5	4.5	2.5	6.0

Table 2—Bare or covered conductor at an operating voltage of 19kV

Voltage	All spans	Span (in metres)									
		0–100		Over 100–200		Over 200–300		Over 300–400		Over 400	
	P	V	H	V	H	V	H	V	H	V	H
19kV single wire earth return (SWER)	0.5	1.0	1.0	1.0	2.5	1.5	5.0	2.0	7.0	2.0	9.0

Table 3—Bare or covered conductor at operating voltages of 33kV and 66kV

Voltage	All spans			Span (in metres)									
				0–100	Over 100–200	Over 200–300	Over 300–400	Over 400–500	Over 500–600	Over 600–700	Over 700–800	Over 800–900	Over 900
	V	P	B	H	H	H	H	H	H	H	H	H	
33kV	2.5	0.5	2.0	2.5	4.5	6.5	9.5	14.0	19.0	25.0	32.0	39.5	48.0
66kV	3.0	1.0	2.0	2.5	4.5	6.5	9.5	14.0	19.0	25.0	32.0	39.5	48.0

Table 4—All conductors operating at voltages of 132kV to 275kV—V, H and S

Voltage	All spans	Span (in metres)																
		0-100	Over 100-150	Over 150-200	Over 200-250	Over 250-300	Over 300-350	Over 350-400	Over 400-450	Over 450-500	Over 500-550	Over 550-600	Over 600-650	Over 650-700	Over 700-750	Over 750-800	Over 800	
132kV	2.5 3.0	V	3.0	4.0	5.0	5.0	5.0	6.0	6.0	6.0	6.0	6.0	6.0	6.0	6.0	6.0	6.0	6.0
		H	3.0	4.0	6.0	8.0	10.0	11.0	14.0	17.0	20.0	23.0	28.0	32.0	37.0	41.0	47.0	58.0
		S	0	2.0	2.0	4.0	5.0	6.0	8.0	10.0	12.0	14.0	16.0	19.0	22.0	25.0	29.0	36.0
		S*	0	1.0	1.0	3.0	3.0	5.0	5.0	8.0	8.0	13.0	13.0	19.0	19.0	26.0	26.0	32.0
275kV	4.5 3.0	V	4.5	5.0	6.0	7.0	7.0	7.0	8.0	8.0	8.0	8.0	8.0	8.0	8.0	8.0	8.0	8.0
		H	4.5	5.0	6.0	7.0	9.0	10.0	11.0	13.0	15.0	17.0	19.0	22.0	24.0	27.0	30.0	37.0
		S	1.0	2.0	2.0	3.0	4.0	5.0	6.0	7.0	8.0	10.0	11.0	13.0	15.0	17.0	19.0	24.0
		S*	1.0	2.0	2.0	3.0	3.0	4.0	4.0	6.0	6.0	9.0	9.0	12.0	12.0	16.0	16.0	21.0

3.5m rule

Where the application of the value set out in Table 4 would result in the bottom edge of the clearance zone having a vertical distance from ground level of less than 3.5 m, the bottom edge of the clearance zone shall have a vertical distance from ground level of 3.5 m irrespective of the vertical distance it would otherwise have had from ground level by virtue of the value of V.

6—Technical Regulator may determine values for clearance zone around particular powerline in certain circumstances

- (1) The Technical Regulator may, on application by an electricity entity with a duty under section 55 of the Act in relation to an overhead 132kV or 275kV powerline, determine that for the purposes of that duty in relation to a specified portion of the powerline the value of V, H, B or S is to be a specified number of metres instead of the value given in clause 5.
- (2) The Technical Regulator must not make a determination under subclause (1) unless satisfied by the electricity entity that the clearance zone will still extend at least—
 - (a) in the case of a 132kV line—1.5 m; or
 - (b) in the case of a 275kV line—2.5 m,
 beyond any point to which the line may swing or sag at a wind pressure of 400Pa (taking into account the length of the span concerned and the characteristics of the line).
- (3) An application under this regulation must—
 - (a) be made in a form approved by the Technical Regulator; and
 - (b) contain the information specified in the form; and
 - (c) be accompanied by an application fee fixed by the Minister.
- (4) A determination under this regulation must be in writing.
- (5) The Technical Regulator may, by notice in writing to an electricity entity with a duty under section 55 of the Act in relation to a powerline to which a determination under this regulation relates, vary or revoke the determination.

Schedule 2—Planting or nurturing vegetation near public powerlines

1—Interpretation

In this Schedule—

exempt vegetation means—

- (a) vegetation (such as small plants that produce flowers or vegetables, ground covers, cereal crops or small bushes or shrubs) with an expected mature height of less than 2 m;
- (b) vegetation in relation to which an exemption is in force under these regulations;

prescribed distance means—

- (a) in the case of a powerline constructed to operate at a voltage listed below—the distance set out below in relation to that voltage:

Voltage	Distance (in metres)
500kV	19.0
275kV	12.5
132kV, other than a single pole	15.0
132kV, single pole	10.0
66kV	6.5

- (b) in any other case—6 m.

2—General rules

- (1) Subject to clause 3, only vegetation of a kind set out in the third column of Table 1 may be planted within the distance set out in the second column from a powerline of a kind set out in the first column.
- (2) Subject to clause 3, only vegetation of a kind set out in the third or fourth column of Table 1 may be nurtured if it is growing within the distance set out in the second column from a powerline of a kind set out in the first column.

3—Exemption

Vegetation may be planted in proximity to a public powerline in a non-bushfire risk area and any such vegetation may be nurtured, if—

- (a) the vegetation is planted in replacement of vegetation in a stand or avenue of vegetation situated along a road; and
- (b) the vegetation is of the same species as that being replaced.

4—Tables

Table 1—General rules

Powerline	Distance within which planting or nurturing is controlled	Vegetation which may be planted or nurtured	Additional vegetation which may be nurtured
Overhead public powerline, the conductors of which are not insulated, in the bushfire risk area.	Prescribed distance from centreline.	Species listed in Table 2. Exempt vegetation.	Any vegetation planted or self-sown before 1 November 1988.
	More than the prescribed distance but less than twice the prescribed distance from centreline.	Species listed in Table 2 or 3. Exempt vegetation.	Any vegetation planted or self-sown before 1 November 1988.
Any other overhead public powerline.	Prescribed distance from centreline.	Species listed in Table 2 or 3. Exempt vegetation.	Any vegetation planted or self-sown before 1 November 1988.
Underground public powerline constructed to operate at a voltage of 66kv or more.	3 m from centreline.	Species listed in Table 2 Exempt vegetation.	Any vegetation planted or self-sown before 1 November 1988.
Any other underground public powerline.	No control.		

Table 2—Vegetation with an expected mature height of 3 m or less that may be planted in proximity to certain public powerlines

Botanical Name	Common name
<i>Abelia</i> species	
<i>Abutilon</i> species	
<i>Acacia acinacea</i>	Gold Dust Wattle
<i>Acacia anceps</i>	
<i>Acacia brachybotrya</i>	Grey Mulga
<i>Acacia cardiophylla</i>	Wyalong Wattle
<i>Acacia drummondii</i>	Drummond Wattle
<i>Acacia glaucoptera</i>	Flat Wattle
<i>Acacia glandulicarpa</i>	Hairy Pod Wattle
<i>Acacia microcarpa</i>	Manna Wattle
<i>Acacia myrtifolia</i>	Myrtle Wattle
<i>Acacia rotundifolia</i>	Round Leaf Wattle
<i>Acacia sclerophylla</i>	Hard-leaf Wattle
<i>Acokanthera oblongifolia</i>	
<i>Actinostrobus pyramidalis</i>	Swan River Cypress
<i>Allocasuarina muelleriana</i>	
<i>Allocasuarina nana</i>	Stunted Sheoak
<i>Alyogyne</i> species	Desert Rose
<i>Alyxia buxifolia</i>	Sea Box
<i>Amelanchier sanguinea</i>	
<i>Anigozanthos</i> species	Kangaroo Paw
<i>Arundinaria</i> (cultivars) (except those in Table 3)	Ornamental Bamboos
<i>Atriplex</i> species	Saltbush
<i>Banksia caleyi</i>	Caley's Banksia
<i>Banksia dryandroides</i>	Dryandra-leaved Banksia
<i>Banksia hookeriana</i>	Hooker's Banksia
<i>Banksia nutans</i>	Nodding Banksia
<i>Banksia ornata</i>	Desert Banksia
<i>Banksia sphaerocarpa</i>	Round-fruited Banksia
<i>Beaufortia sparsa</i>	Swamp Bottlebrush
<i>Boronia</i> species (except <i>B. muelleri</i>)	
<i>Buxus sempervirens</i> (cultivars)	
<i>Callistemon</i> species (except those in Table 3 and <i>C. salignus</i>)	Bottlebrush
<i>Calothamnus</i> species	Netbush
<i>Calytrix</i> species	eg Snow Myrtle, Fringe Myrtle
<i>Camellia sasanqua</i>	

Botanical Name	Common name
<i>Carissa bispinosa</i>	
<i>Carissa grandiflora</i>	Natal Plum
<i>Cephalotaxus harringtonia</i>	Japanese Plum-Yew
<i>Chamaecyparis lawsoniana</i> 'Ellwoodii'	
<i>Chamaecyparis lawsoniana</i> 'Olbrichi'	
<i>Chamaecyparis lawsoniana</i> 'Pottenii'	
<i>Chamaecyparis lawsoniana</i> 'Tamariscifolia'	
<i>Chamaecyparis obtusa</i> 'Aurea' (and other dwarf cultivars)	
<i>Chamaecyparis pisifera</i> 'Filifera' (and other dwarf cultivars)	
<i>Chamaerops humilis</i>	Mediterranean Palm
<i>Chamelaucium</i> species	Esperance Wax
<i>Citriobatus pauciflorus</i>	
<i>Citrus limon</i> 'Variegata'	Variegated Lemon
<i>Colletia paradoxa</i>	
<i>Coprosma repens</i>	Mirror Bush
<i>Cordyline stricta</i>	Erect Palm-Lily
<i>Cotoneaster frigidus</i>	Himalayan Cotoneaster
<i>Cortaderia rudiusscula</i>	N.Z. Pink Pampass-Grass
<i>Cycas revoluta</i>	Sago-Plum
<i>Cyperus papyrus</i>	Papyrus
<i>Cyphomandra betacea</i>	Tree Tomato
<i>Cytisus</i> species (except those in Table 3 and <i>C. scoparius</i>)	
<i>Dahlia imperialis</i>	
<i>Datura cornigera</i> (<i>Brugmansia knightii</i>)	
<i>Datura sanguinea</i>	
<i>Deutzia</i> species	
<i>Dodonaea</i> species (except <i>D. viscosa</i>)	Hop Bushes
<i>Dombeya natalensis</i>	
<i>Dombeya tiliacea</i>	
<i>Doryanthes</i> species	Spear Lily
<i>Dracaena umbraculifera</i>	
<i>Duboisia hopwoodii</i>	Pituri
<i>Eremophila fraseri</i>	Turpentine Bush
<i>Eremophila mackinlayi</i>	Desert Pride
<i>Eremophila maculata</i>	Spotted Emu Bush
<i>Erica</i> species (except <i>E. arborea</i>)	Heath
<i>Eriostemon</i> species	Native Daphne, Waxflower
<i>Erythrina acanthocarpa</i>	Tambookie Thorn Tree

Botanical Name	Common name
<i>Erythrina</i> 'Blakei'	Coral Tree
<i>Erythrina hendersonii</i>	
<i>Escallonia</i> 'C F Ball'	
<i>Escallonia</i> 'Edinburgh'	
<i>Escallonia</i> 'Fretheyi'	
<i>Escallonia</i> 'Iveyi'	
<i>Escallonia</i> x <i>langleyensis</i>	
<i>Escallonia macrantha</i>	
<i>Escallonia</i> 'Slieve Donard'	
<i>Eucalyptus kruseana</i>	Bookleaf Mallee
<i>Eucalyptus nutans</i>	Red-flowered Moort
<i>Eucalyptus pachyphylla</i>	Thick—leaved Mallee
<i>Eucalyptus preissiana</i>	Bell-fruited Mallee
<i>Eucalyptus rhodantha</i>	Rose Mallee
<i>Euonymus alata</i>	Cork Tree
<i>Euonymus hamiltoniana</i> var <i>yedeonsis</i>	
<i>Euphorbia</i> species (except <i>E. candelabra</i>)	
<i>Fortunella</i> species	Cumquat
<i>Geijera linearifolia</i>	Sheep Bush
<i>Genista</i> species (except <i>G. aethnensis</i> , <i>G. virgata</i> and <i>G. monspessulanus</i>)	
<i>Goodia lotifolia</i>	Golden Tip
<i>Gordonia axillaris</i>	
<i>Gossypium barbadense</i>	Sea Island Cotton
<i>Grevillea</i> species (except those in Table 3 and <i>G. robusta</i> , <i>G. hilliana</i> and <i>G. striata</i>)	
<i>Hakea francisiana</i>	Bottlebrush Hakea
<i>Hakea leucoptera</i>	Needle Bush
<i>Hakea muelleriana</i>	Muller's Hakea
<i>Hakea nodosa</i>	Yellow Hakea
<i>Hakea orthorrhyncha</i>	
<i>Hakea sericea</i>	Silky Hakea
<i>Hakea sulcata</i>	Furrowed Hakea
<i>Hakea undulata</i>	Wavy-leaved Hakea
<i>Hesperoyucca whipplei</i>	
<i>Hibbertia</i> species	Guinea Flower
<i>Hibiscus</i> species	
<i>Hovea</i> species	
<i>Howittea trilocularis</i>	Native Hibiscus

Botanical Name	Common name
<i>Hydrangea</i> species	
<i>Ilex cornuta</i>	Chinese Holly
<i>Ilex verticillata</i>	Black Alder
<i>Illicium floridanum</i>	Purple Anise
<i>Indigofera</i> species	
<i>Jasminum fruticans</i>	
<i>Jasminum multiflorum</i>	Hairy Jasmine
<i>Juniperus communis</i> 'Hibernica'	Irish Juniper
<i>Juniperus sabina</i>	Savin Juniper
<i>J. x media</i> (hybrids)	
<i>Kalmia latifolia</i>	Calico Bush
<i>Kerria japonica</i>	
<i>Kolkwitzia amabilis</i>	Beauty Bush
<i>Kunzea</i> species (except <i>K. ambigua</i>)	
<i>Lantana camara</i> 'cultivars' (except Common Lantana)	
<i>Lavatera</i> species	
<i>Leptospermum nitidum</i> 'Copper Sheen'	
<i>Leptospermum rotundifolium</i>	
<i>Leptospermum scoparium</i> (dwarf varieties)	
<i>Leptospermum sericeum</i>	Silver Tea Tree
<i>Leptospermum squarrosum</i>	Pink Tea Tree
<i>Leucadendron salignum</i>	
<i>Ligustrum delavayanum</i>	
<i>Ligustrum amurense</i>	Amur Privet
<i>Ligustrum japonicum</i> var. <i>rotundifolium</i>	
<i>Ligustrum ovalifolium</i> 'Aureum'	Golden Hedge Privet
<i>Ligustrum undulatum</i>	New Guinea Privet
<i>Ligustrum vulgare</i>	European Privet
<i>Linospadix monostachus</i>	Walking-stick Palm
<i>Lonicera</i> species	Honeysuckle
<i>Macrozamia</i> species	eg Pineapple Palm
<i>Magnolia stellata</i>	Star Magnolia
<i>Maireana</i> species (Syn. <i>Kochia</i>)	eg Blue Bush
<i>Malus</i> 'Echtermeyer'	
<i>Malus</i> 'Gorgeous'	
<i>Malus sargentii</i>	
<i>Malvaviscus arboreus</i>	
<i>Melaleuca coccinea</i>	Goldfield's Bottlebrush

Botanical Name	Common name
<i>Melaleuca brevifolia</i>	White-flowered Paperbark
<i>Melaleuca decussata</i>	
<i>Melaleuca elachophylla</i>	
<i>Melaleuca elliptica</i>	Granite Honey Myrtle
<i>Melaleuca fulgens</i>	Scarlet Honey Myrtle
<i>Melaleuca gibbosa</i>	
<i>Melaleuca hamulosa</i>	
<i>Melaleuca hypericifolia</i>	Hillock Honey Myrtle
<i>Melaleuca incana</i>	Grey Honey Myrtle
<i>Melaleuca lateritia</i>	Robin Redbreast Bush
<i>Melaleuca megacephala</i>	
<i>Melaleuca micromera</i>	
<i>Melaleuca microphylla</i>	
<i>Melaleuca nematophylla</i>	Wiry Honey Myrtle
<i>Melaleuca oraria</i>	White-flowered Paperbark
<i>Melaleuca pentagona</i>	
<i>Melaleuca pulchella</i>	Claw Flower
<i>Melaleuca quadrifaria</i>	Limestone Honey Myrtle
<i>Melaleuca radula</i>	
<i>Melaleuca scabra</i>	Rough Honey Myrtle
<i>Melaleuca spathulata</i>	
<i>Melaleuca squamea</i>	Swamp Honey Myrtle
<i>Melaleuca steedmanii</i>	Steedman's Honey Myrtle
<i>Melaleuca thymifolia</i>	Thyme Honey Myrtle
<i>Melaleuca trichophylla</i>	
<i>Melaleuca uncinata</i>	Broombush Honey Myrtle
<i>Melaleuca wilsonii</i>	Wilson's Honey Myrtle
<i>Michelia figo</i>	Port Wine Magnolia
<i>Mirbelia species</i>	
<i>Miscanthus sinensis</i>	
<i>Montanoa species</i>	eg Mexican Tree Daisy
<i>Murraya paniculata</i>	
<i>Myoporum floribundum</i>	
<i>Nolina recurvata</i>	
<i>Olearia species</i>	Daisy Bush
<i>Osmanthus aurantiacus</i>	
<i>Osmanthus 'Fortunei'</i>	
<i>Osmanthus heterophyllus</i> (varieties except 'Ilicifolius')	

Botanical Name	Common name
<i>Philadelphus</i> species	
<i>Phormium tenax</i>	N.Z. Flax
<i>Photinia glabra</i> 'Rubens'	Red-leaf Photinia
<i>Photinia</i> 'Robusta'	
<i>Picea glauca</i> var. <i>albertiana</i> 'Conica'	
<i>Pimelea</i> species	Rice Flower
<i>Plumbago auriculata</i>	
<i>Podocarpus lawrencei</i>	Mountain Plum Pine
<i>Polygala</i> species	
<i>Prostanthera</i> species	Mint Bush
<i>Protea</i> species	
<i>Prunus avium</i> 'Pendula'	Weeping Gean
<i>Prunus glandulosa</i> 'Alboplena'	Bush Cherry
<i>Prunus japonica</i>	Chinese Cherry
<i>Prunus spinosa</i> Purpurea'	Purple-leaf Blackthorn
<i>Prunus tenella</i> var. <i>gesslerana</i>	Dwarf Russian Almond
<i>Prunus triloba</i> 'Plena'	
<i>Psidium littorale</i>	Strawberry Guava
<i>Psoralea pinnata</i>	
<i>Pyracantha angustifolia</i>	Orange Firethorn
<i>Pyracantha coccinea</i>	
<i>Pyracantha crenulata</i>	Nepal Firethorn
<i>Pyracantha fortuneana</i>	
<i>Pyracantha rogersiana</i>	
<i>Rhamnus alaternus</i> 'Argenteovariegata'	
<i>Rhaphiolepis umbellata</i>	
<i>Rhaphiolepis</i> x <i>delacourii</i>	
<i>Ribes</i> species	Currant
<i>Robinia kelseyi</i>	
<i>Senna</i> species (except <i>S. brewsteri</i>)	eg Desert Cassia
<i>Sparmannia</i> species	
<i>Taxus baccata</i> 'cultivars' (except Common Yew)	
<i>Telopea mongaensis</i>	
<i>Telopea speciosissima</i>	
<i>Templetonia retusa</i>	
<i>Thryptomene</i> species	
<i>Viburnum tinus</i>	Laurestinus
<i>Xylomelum angustifolium</i>	Sandplain Woody Pear
<i>Yucca</i> species	Yucca

Table 3—Vegetation with an expected mature height of more than 3 m but not more than 6 m that may be planted in proximity to certain public powerlines

Botanical Name	Common name
<i>Acacia acuminata</i>	Raspberry Jam Wattle
<i>Acacia aneura</i>	Mulga
<i>Acacia argyrophylla</i>	Golden Grey Mulga
<i>Acacia calamifolia</i>	Wallowa Wattle
<i>Acacia cultriformis</i>	Knife Leaf Wattle
<i>Acacia cyclops</i>	Western Coastal Wattle
<i>Acacia dodonaeifolia</i>	Hop-leaved Wattle
<i>Acacia gracilifolia</i>	
<i>Acacia hakeoides</i>	Hakea Leaved Wattle
<i>Acacia iteaphylla</i>	Flinders Range Wattle
<i>Acacia ligulata</i>	Umbrella Bush
<i>Acacia longifolia</i>	Sallow Wattle
<i>Acacia notabilis</i>	Notable Wattle
<i>Acacia oswaldii</i>	Umbrella Wattle
<i>Acacia pycnantha</i>	Golden Wattle
<i>Acacia rigens</i>	Nealie
<i>Acacia sophorae</i>	Coastal Wattle
<i>Acacia spectabilis</i>	Mudgee Wattle
<i>Acacia suaveolens</i>	Sweet Wattle
<i>Acacia trineura</i>	Hindmash Wattle
<i>Acacia verniciflua</i>	Varnished Wattle
<i>Acacia vestita</i>	Hairy Wattle
<i>Acacia victoriae</i>	Elegant Wattle
<i>Acer buergerianum</i>	Trident Maple
<i>Acer ginnala</i>	Amur Maple
<i>Acer grosseri</i>	
<i>Acer japonicum</i>	Full-moon Maple
<i>Acer palmatum</i>	Japanese Maple
<i>Acer pennsylvanicum</i>	Striped Maple
<i>Acer sieboldianum</i>	
<i>Alberta magna</i>	
<i>Aleurites fordii</i>	Tung-oil Tree
<i>Allocasuarina paludosa</i>	Scrub Sheoak
<i>Aloysia triphylla</i>	Lemon-scented Verbena
<i>Amelanchier andrachne</i>	
<i>Amelanchier asiatica</i>	

Botanical Name	Common name
<i>Amelanchier laevis</i>	
<i>Angophora cordifolia</i> (syn. <i>A. hispida</i>)	Dwarf Apple-Myrtle
<i>Annona</i> species	Custard Apple
<i>Anopterus glandulosus</i>	Tasmanian Laurel
<i>Arbutus unedo</i>	Strawberry Tree
<i>Aristotelia serrata</i>	Makomako
<i>Arundinaria hindsii</i>	Kanzan-Chiku
<i>Arundinaria japonica</i>	Metake
<i>Arundinaria linearis</i>	Narrow-leaf Bamboo
<i>Arundo donax</i>	Danubian Reed
<i>Aesculus pavia</i>	Red Buckeye
<i>Azara lanceolata</i>	
<i>Azara microphylla</i>	Box-leaf Azara
<i>Baccharis halimifolia</i>	
<i>Bambusa multiplex</i>	Hedge Bamboo
<i>Banksia ashbyi</i>	Ashby's Banksia
<i>Banksia baueri</i>	Possum Banksia
<i>Banksia baxteri</i>	Birds-nest Banksia
<i>Banksia brownii</i>	Brown's Banksia
<i>Banksia burdettii</i>	Burdett's Banksia
<i>Banksia collina</i>	Hill Banksia
<i>Banksia media</i>	Golden Stalk
<i>Banksia speciosa</i>	Showy Banksia
<i>Bauhinia</i> species	eg Orchid Tree
<i>Betula pendula</i> 'Youngii'	Weeping Birch
<i>Boronia muelleri</i>	Tree Boronia
<i>Brachylottis repanda</i> 'Purpurea'	
<i>Brahea armata</i>	Blue Palm
<i>Buddleja colvilei</i>	
<i>Buddleja davidii</i>	Butterfly Bush
<i>Buddleja madagascariensis</i>	
<i>Butia capitata</i>	Wine Palm
<i>Butia yatay</i>	
<i>Calliandra portoricensis</i>	
<i>Callistemon</i> 'Burgundy'	
<i>Callistemon citrinus</i>	Red Bottlebrush
<i>Callistemon</i> 'Harkness'	
<i>Callistemon phoeniceus</i>	Fiery Bottlebrush

Botanical Name	Common name
<i>Callistemon polandii</i>	
<i>Callistemon rigidus</i>	Stiff-leaved Bottlebrush
<i>Callistemon viminalis</i>	Weeping Bottlebrush
<i>Callitris drummondii</i>	
<i>Callitris oblonga</i>	Tasmanian Cypress Pine
<i>Callitris verrucosa</i>	Mallee Pine
<i>Calpurnia aurea</i>	African Laburnum
<i>Camellia</i> species	Camellias
<i>Caryota mitis</i>	Fish Tail Palm
<i>Ceanothus</i> species	Californian Lilac
<i>Chamaecyparis lawsoniana</i> 'Allumii'	
<i>Chamaecyparis lawsoniana</i> 'Darleyensis'	
<i>Chamaecyparis lawsoniana</i> 'Fletcheri'	
<i>Chamaecyparis lawsoniana</i> 'Lutea'	Golden Lawson Cypress
<i>Chamaecyparis lawsoniana</i> 'Stewartii'	
<i>Chamaecyparis lawsoniana</i> 'Westermanii'	
<i>Chamaecyparis obtusa</i> (except dwarf cultivars)	
<i>Chamaecyparis pisifera</i> 'Argentea'	
<i>Chamaecyparis pisifera</i> 'Squarrosa'	
<i>Chamaecyparis thyoides</i> 'Glauca'	
<i>Chamaecytisus proliferus</i>	False Tree Lucerne
<i>Chamelaucium uncinatum</i>	Geraldton Wax
<i>Chionanthus retusa</i>	
<i>Citharexylum fruticosum</i>	Florida Fiddlewood
<i>Citrus aurantifolia</i>	Sweet Lime
<i>Citrus limon</i>	Wild Lemon
<i>Citrus medica</i>	Citron
<i>Citrus reticulata</i>	Mandarin Orange
<i>Cordyline terminalis</i>	Ti-Port
<i>Cornus mas</i>	
<i>Corokia macrocarpa</i>	
<i>Corylus avellana</i>	European Hazelnut
<i>Corymbia ficifolia</i> 'Dwarf'	'Summertime' Grafted Red Flowering Gum
<i>Cotinus obovatus</i>	
<i>Cotinus coggygria</i>	Smoke Tree
<i>Cotoneaster</i> 'Cornubia'	
<i>Cotoneaster</i> 'Watereri'	

Botanical Name	Common name
<i>Cotoneaster glaucophyllus</i> (<i>C. serotinus</i>)	
<i>Crataegus chrysocarpa</i>	
<i>Crataegus coccineoides</i>	Kansas Hawthorn
<i>Crataegus crus-galli</i>	Cockspur Thorn
<i>Crataegus durobrivensis</i>	
<i>Crataegus ellwangeriana</i>	
<i>Crataegus orientalis</i>	Silver Hawthorn
<i>Crataegus phaenopyrum</i>	Washington Thorn
<i>Crataegus pinnatifida</i> var. <i>major</i>	
<i>Crataegus prunifolia</i>	Plumleaf Hawthorn
<i>Crataegus</i> x <i>grignonensis</i>	
<i>Crataegus</i> x <i>lavalleyi</i>	French Hawthorn
<i>Crinodendron hookerianum</i>	Red Lantern Tree
<i>Cupressus glabra</i> 'Hodginsii'	
<i>Cussonia spicata</i>	
<i>Cuttsia viburnea</i>	
<i>Cycas media</i>	Baveu
<i>Cytisus battandieri</i>	
<i>Cytisus multiflorus</i>	
<i>Dais cotinifolia</i>	Pompon Tree
<i>Datura arborea</i>	
<i>Datura suaveolens</i> (Burgmansia)	Angels Trumpet
<i>Dicksonia antarctica</i>	Soft Tree-Fern
<i>Dodonea viscosa</i>	Hop Bush
<i>Dracaena</i> species	eg Dragon Tree
<i>Dryandra formosa</i>	
<i>Duranta</i> species	Sky Flower
<i>Elaeagnus</i> species	Russian Olive
<i>Elaeodendron australe</i>	Scarlet Olive-Wood
<i>Entelea arborescens</i>	Whau
<i>Eremophila</i> species	Emu Bush
<i>Erica arborea</i>	Tree Heath
<i>Erythrina fusca</i>	
<i>Erythrina humeana</i>	Coral Tree
<i>Erythrina parcellii</i>	Variegated Coral Tree
<i>Erythrina phlebocarpa</i>	Veined-pod Coral Tree
<i>Erythrina senegalensis</i>	
<i>Erythrina speciosa</i>	

Botanical Name	Common name
<i>Erythrina x bidwillii</i>	
<i>Escallonia</i> species	
<i>Eucalyptus angulosa</i>	Ridge Fruited Mallee
<i>Eucalyptus brachycalyx</i>	Gilja or Chindoo Mallee
<i>Eucalyptus caesia</i> 'Silver Princess'	
<i>Eucalyptus calycogona</i> 'Jubilee'	Jubilee Gum
<i>Eucalyptus cosmophylla</i>	Cup Gum
<i>Eucalyptus crucis</i>	Southern Cross Mallee
<i>Eucalyptus decipiens</i>	Limestone Marlock
<i>Eucalyptus dielsii</i>	Cap-fruited Mallee
<i>Eucalyptus dumosa</i>	White Mallee
<i>Eucalyptus erythronema</i>	Lindsay Gum
<i>Eucalyptus forrestiana</i>	Fuchsia Gum
<i>Eucalyptus gillii</i>	Curly Mallee
<i>Eucalyptus grossa</i>	Coarse-leaved Mallee
<i>Eucalyptus kingsmillii</i>	Kingsmill Mallee
<i>Eucalyptus lansdowneana</i>	Pt. Lincoln Gum & Crimson Mallee
<i>Eucalyptus lansdowneana albopurpurea</i>	Port Lincoln Gum
<i>Eucalyptus lansdowneana lansdowneana</i>	Crimson Mallee
<i>Eucalyptus leucoxylon</i> 'Magnet'	'Euky Dwarf'
<i>Eucalyptus macrandra</i>	Longflowered Marlock
<i>Eucalyptus macrocarpa</i>	Mottlecah
<i>Eucalyptus orbifolia</i>	Round-leaved Mallee
<i>Eucalyptus pauciflora</i> 'Frosty'	Edna Walling 'Little Snowman'
<i>Eucalyptus pyriformis</i> (not <i>E.p.youngiana</i>)	Pear-fruited Mallee
<i>Eucalyptus redunca</i>	Black Marlock
<i>Eucalyptus rugosa</i>	Kingscote Mallee
<i>Eucalyptus stoatei</i>	Scarlet Pear Gum
<i>Eucalyptus tetragona</i>	Tallerack
<i>Eucalyptus tetraptera</i>	Four-winged Mallee
<i>Eucalyptus viridis</i>	Green Mallee
<i>Eucalyptus websterana</i>	Webster's Mallee
<i>Eucryphia glutinosa</i>	
<i>Eugenia aggregata</i>	Rio Grande Cherry
<i>Eugenia uniflora</i>	Surinam Cherry
<i>Euonymus fortunei</i>	Spindle Tree
<i>Euonymus japonicus</i>	Evergreen Spindle Tree
<i>Euonymus latifolia</i>	

Botanical Name	Common name
<i>Euonymus pendula</i>	
<i>Eupomatia laurina</i>	Copper Laurel
<i>Exochorda</i> species	Pearl Bush
<i>Feijoa sellowiana</i>	Pineapple Guava
<i>Fraxinus ornus</i>	Manna Ash
<i>Fraxinus</i> "Raywood" on <i>ornus</i> root stock	Dwarf Claret Ash
<i>Fremontodendron californicum</i>	Flannel Bush
<i>Garrya elliptica</i>	
<i>Gastrolobium bilobum</i>	Poison Pea
<i>Geijera parviflora</i>	Wilga
<i>Genista aethnensis</i>	Mt. Etna Broom
<i>Grevillea nematophylla</i>	Silver Leaved Water Bush
<i>Hakea</i> species	eg Oval-leaved Hakea
<i>Hamamelis</i> species	eg Witch Hazel
<i>Hebe diosmaefolia</i>	
<i>Hedycarya angustifolia</i>	Austral Mulberry
<i>Hoheria lyallii</i>	Ribbonwood
<i>Hovenia dulcis</i>	Japanese Raisin Tree
<i>Howea belmoreana</i>	Curly Palm
<i>Howea forsterana</i>	Kentia Palm
<i>Ilex crenata</i>	Japanese Holly
<i>Ilex paraguariensis</i>	Paraguay Tree
<i>Ilex purpurea</i>	Java Holly
<i>Illicium anisatum</i>	Japanese Staranise
<i>Itea ilicifolia</i>	
<i>Jasminum mesnyi</i>	Primrose Jasmin
<i>Jasminum nudiflorum</i>	Winter Jasmin
<i>Juniperus chinensis</i> 'Aurea'	Golden Chinese Juniper
<i>Juniperus communis</i> var. <i>suecica</i>	Swedish Juniper
<i>Koelreuteria paniculata</i>	Golden Rain Tree
<i>Kunzea ambigua</i>	White Kunzea
<i>Laburnum</i> species	Grafted Laburnums
<i>Lagerstoemia indica</i> all varieties	Crepe Myrtle
<i>Lantana camara</i>	Common Lantana
<i>Lawsonia inermis</i>	Henna
<i>Leptospermum</i> species	Tea Tree
<i>Leucadendron argenteum</i>	Silver Tree
<i>Leucopogon parviflorus</i>	Coast Beard-Heath

Botanical Name	Common name
<i>Ligustrum japonicum</i>	Japanese Tree Privet
<i>Ligustrum japonicum</i> 'Variegatum'	
<i>Ligustrum lucidum</i> 'Tricolor'	
<i>Ligustrum ovalifolium</i>	Californian Privet
<i>Ligustrum sinense</i>	Chinese Privet
<i>Livistona chinensis</i>	
<i>Lophomyrtus bullata</i>	Ramarama
<i>Lophomyrtus obcordata</i>	
<i>Luculia grandifolia</i>	
<i>Magnolia liliiflora</i>	
<i>Magnolia salicifolia</i>	
<i>Magnolia sieboldii</i>	
<i>Magnolia</i> x <i>soulangeana</i> (cultivars)	Saucer Magnolia
<i>Mahonia lomariifolia</i>	
<i>Malus</i> 'Aldenhamensis'	
<i>Malus</i> 'John Downie'	
<i>Malus</i> 'Robert Nairn'	
<i>Malus</i> 'Veitch's Scarlet'	
<i>Malus angustifolia</i>	
<i>Malus halliana</i> 'Parkmanii'	
<i>Malus ioensis</i> 'Plena'	Bechtel Crab
<i>Malus sieboldii</i>	Toringo Crab
<i>Malus</i> x <i>atrosanguinea</i>	Red Japanese Crab Apple
<i>Maytenus boaria</i>	
<i>Melaleuca acuminata</i>	Mallee Honey Myrtle
<i>Melaleuca alternifolia</i>	
<i>Melaleuca bracteata</i>	White Cloud Tree
<i>Melaleuca diosmifolia</i>	
<i>Melaleuca ericifolia</i>	Swamp Paperbark
<i>Melaleuca glomerata</i>	Inland Paperbark
<i>Melaleuca halmaturorum</i>	Coastal Paperbark
<i>Melaleuca huegelii</i>	
<i>Melaleuca preissiana</i>	
<i>Melaleuca nesophila</i>	Western Honey Myrtle
<i>Meryta sinclairii</i>	
<i>Mespilus germanica</i>	Medlar
<i>Microcitrus australasica</i>	Native Finger-Lime
<i>Musa basjoo</i>	

Botanical Name	Common name
<i>Myoporum acuminatum</i> (syn. <i>M.montanum</i>)	Water Bush
<i>Myoporum insulare</i>	Boobialla
<i>Myoporum laetum</i>	Ngaio
<i>Myrsine australis</i>	Mapou
<i>Myrtus</i> species	eg Common Myrtle
<i>Neopanax arboreus</i>	Five-Fingers
<i>Neopanax colensoi</i>	Orihou
<i>Nerium oleander</i>	
<i>Ochlandra maculata</i>	Mottled Bamboo
<i>Omalthus populifolius</i>	Queensland Poplar
<i>Osmanthus</i> species	
<i>Oxydendrum arboreum</i>	Sourwood
<i>Parrotia persica</i>	Persian Witch Hazel
<i>Photinia beauverdiana</i>	
<i>Photinia glabra</i>	
<i>Photinia villosa</i>	
<i>Phyllostachys castillonis</i>	
<i>Phyllostachys nigra</i>	Black Bamboo
<i>Phyllostachys pubescens</i>	Noble Bamboo
<i>Pisonia umbellifera</i> 'Variegata'	
<i>Pittosporum crassifolium</i>	
<i>Pittosporum eugeniodes</i> 'Variegatum'	Silver Tarata
<i>Pittosporum phylliraeoides</i>	
<i>Pittosporum ralphii</i>	
<i>Pittosporum revolutum</i>	Brisbane Laurel
<i>Pittosporum tobira</i>	Tobira
<i>Plumeria rubra</i>	Frangipani
<i>Polyscias balfouriana</i>	
<i>Polyscias guilfoylei</i>	Wild Coffee
<i>Pomaderris</i> species	
<i>Poncirus trifoliata</i>	
<i>Populus x pseudo-grandidentata</i>	Weeping Large-tooth Aspen
<i>Prostanthera lasianthos</i>	Victorian Christmas Bush
<i>Prunus</i> 'Elvins'	
<i>Prunus amygdalus</i>	Almond
<i>Prunus cerasus</i>	Kentish Cherry
<i>Prunus cerasifera</i> 'Nigra'	
<i>Prunus ilicifolia</i>	Islay

Botanical Name	Common name
<i>Prunus incisa</i>	Fuji Cherry
<i>Prunus lustianica</i>	Portugal Laurel
<i>Prunus mume</i> 'Alboplena'	Flowering Apricot
<i>Prunus mume</i> 'Alphandii'	Flowering Apricot
<i>Prunus persica</i> (cultivars)	Peach
<i>Prunus triloba</i>	Bush Almond
<i>Prunus x blireiana</i>	Cherry-Plum
<i>Pseudocydonia oblonga</i>	Quince
<i>Pseudocydonia sinensis</i>	
<i>Psidium guajava</i>	Common Guava
<i>Ptelea trifoliata</i>	Hop-Tree
<i>Punica</i> species	Pomegranate
<i>Pyracantha atalantioides</i>	Firethorn
<i>Pyrus calleryana</i>	Chinese Pear
<i>Pyrus salicifolia</i>	Silver Pear
<i>Rhododendron</i> species	
<i>Robinia hillierii</i>	
<i>Robinia pseudoacacia</i> 'Umbraculisera'	Robinia Mop Top
<i>Sambucus nigra</i>	European Elder
<i>Santalum</i> species	
<i>Senna brewsteri</i>	
<i>Sesbania grandiflora</i>	Agati
<i>Sorbus vilmorinii</i>	
<i>Spartium junceum</i>	Spanish Broom
<i>Stenolobium stans</i> (Tecoma)	
<i>Stewartia sinensis</i>	
<i>Styrax japonica</i>	Snowbell
<i>Tamarix</i> species (except <i>T. aphylla</i>)	
<i>Telopea</i> species	eg Tasmanian Waratah
<i>Thevetia peruviana</i>	Lucky Nut
<i>Thuja orientalis</i> (cultivars)	
<i>Thujopsis dolabrata</i> 'Variegata'	
<i>Tieghemopanax sambucifolius</i>	Elderberry Panax
<i>Tristaniopsis laurina</i> (<i>Tristania laurina</i>)	Water Gum
<i>Ulmus glabra</i> 'Pendula'	Weeping Scotch Elm
<i>Virgilia divaricata</i>	
<i>Vitex agnus-castus</i>	Lilac Chaste Tree

Schedule 3—Maps showing prescribed areas

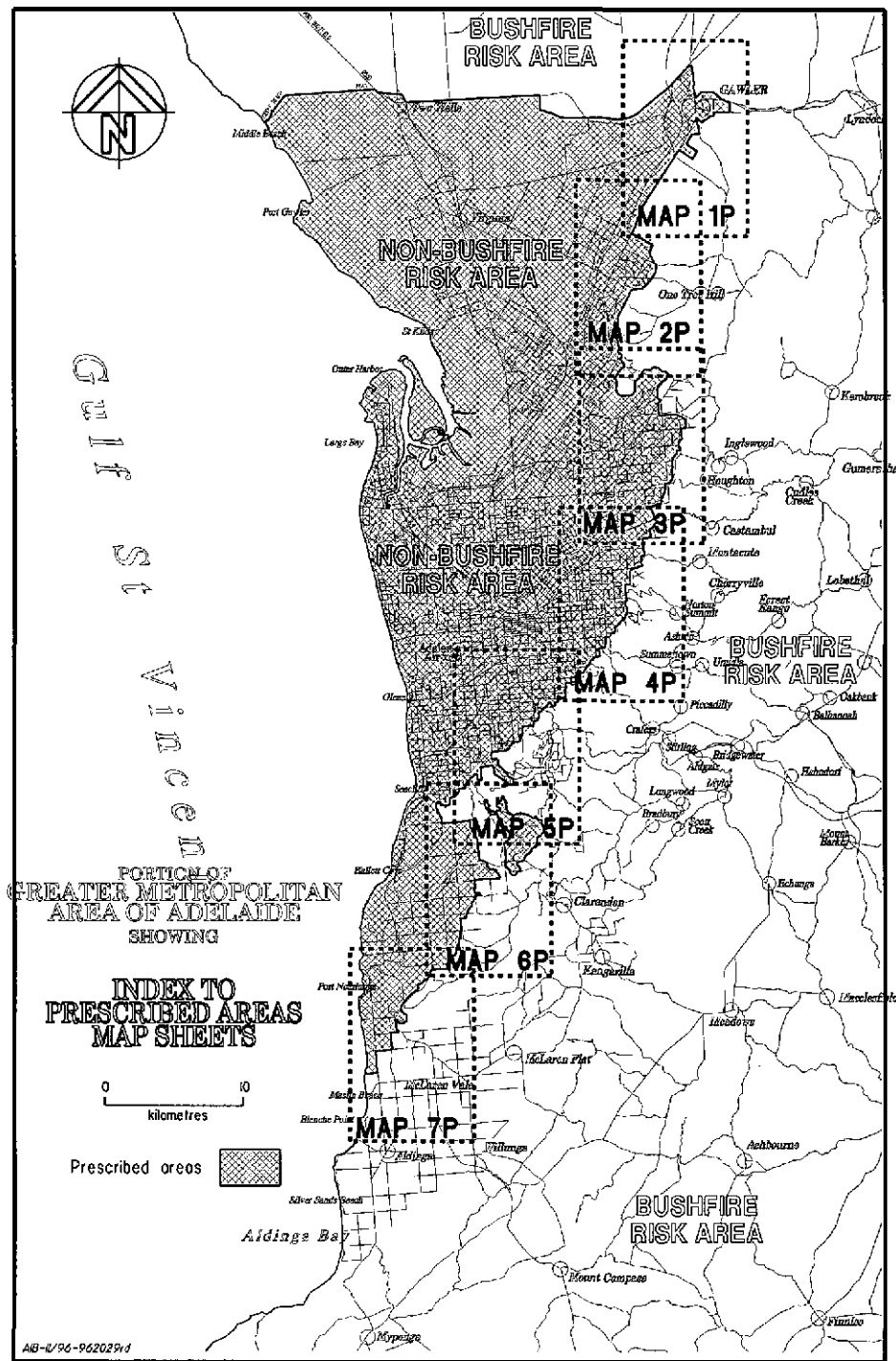

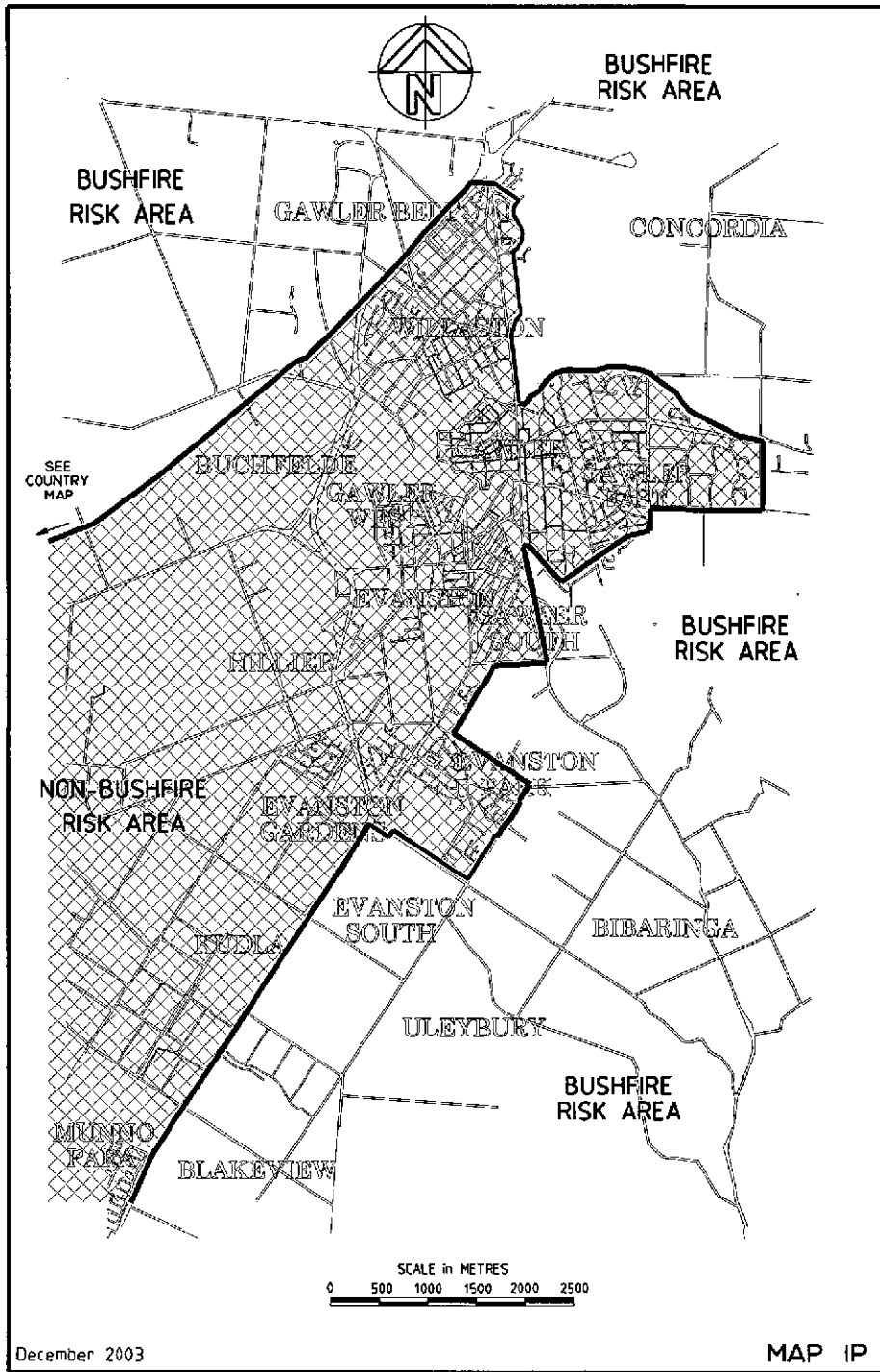

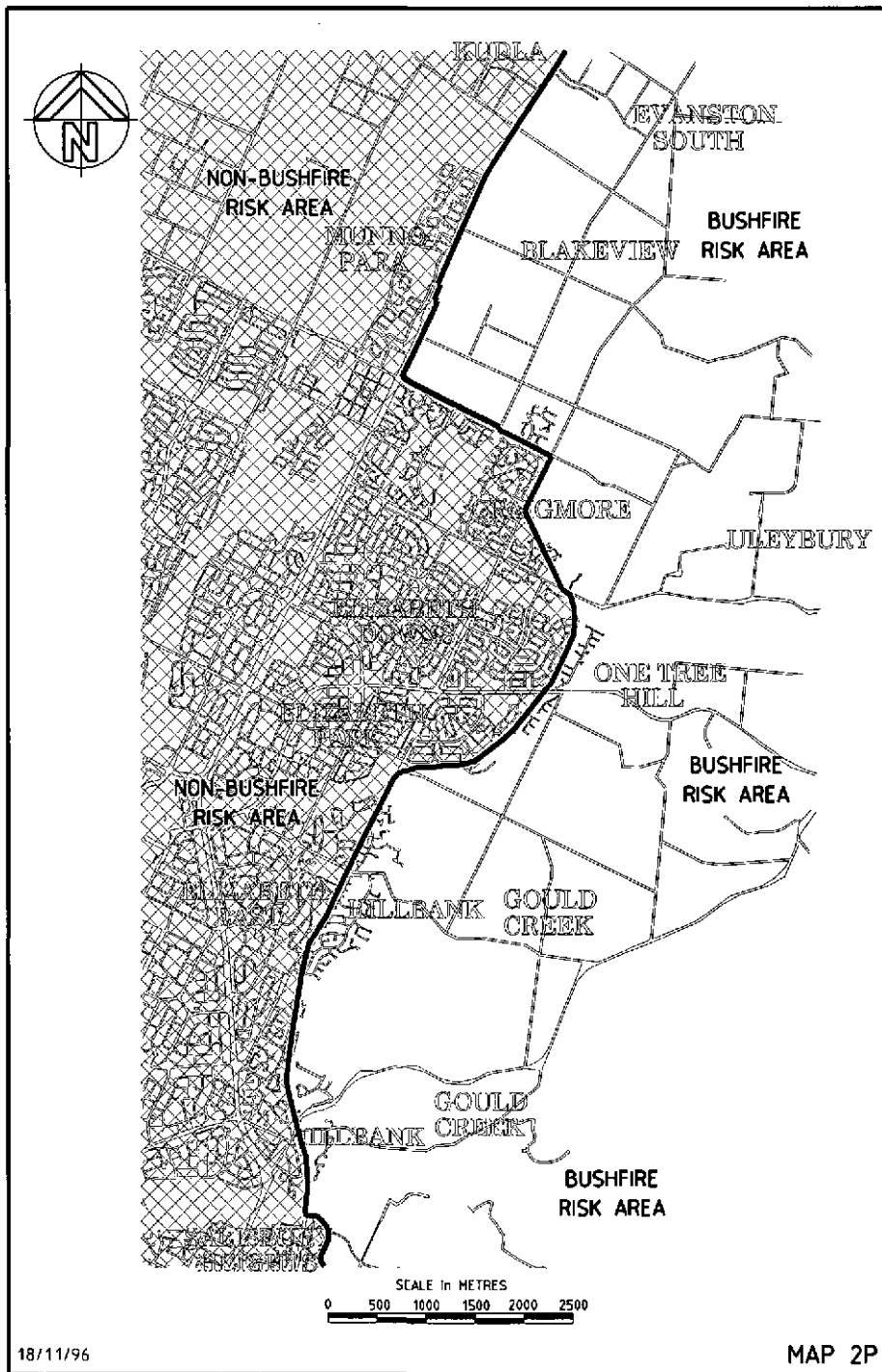

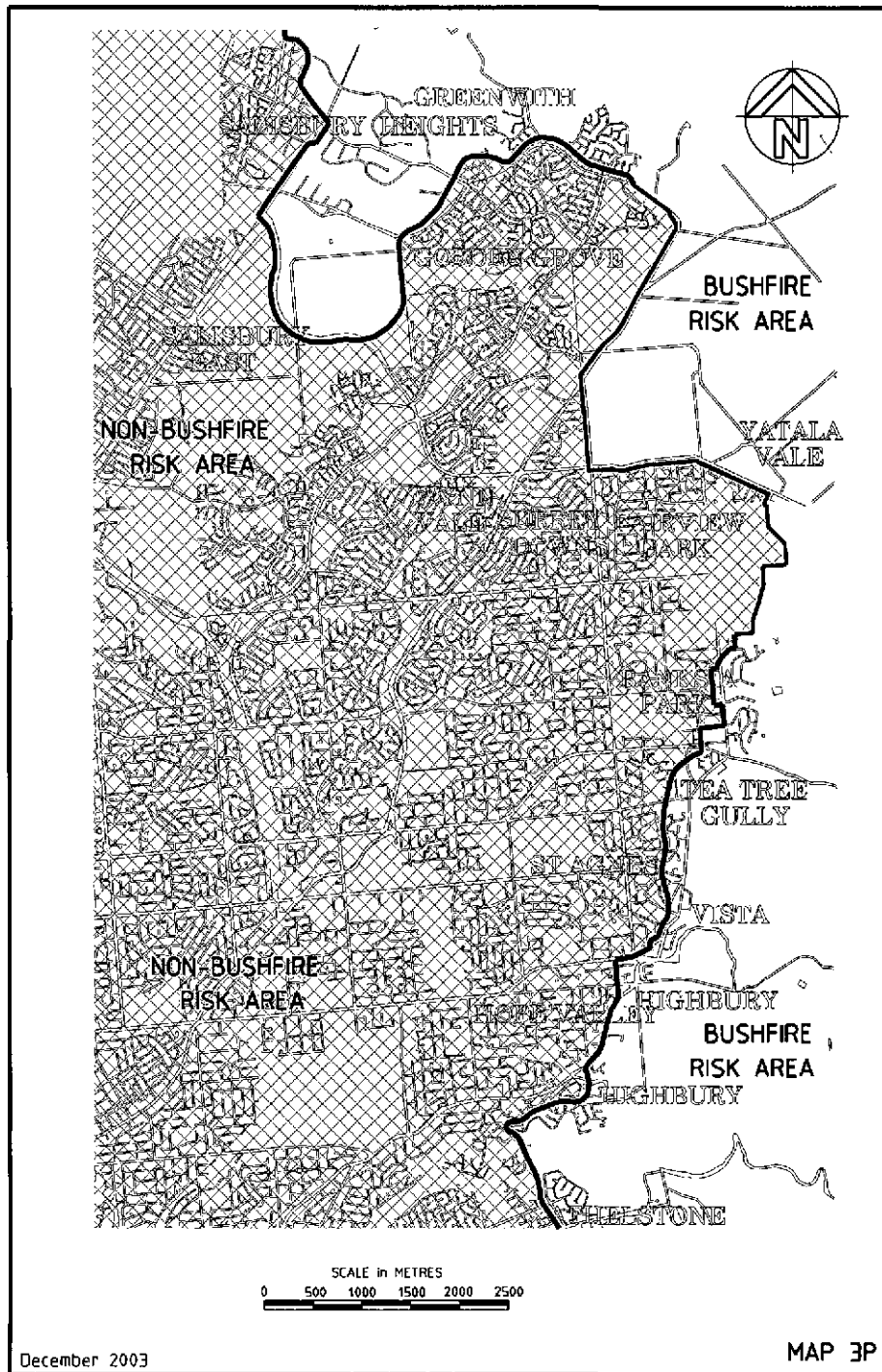

December 2003

MAP 3P

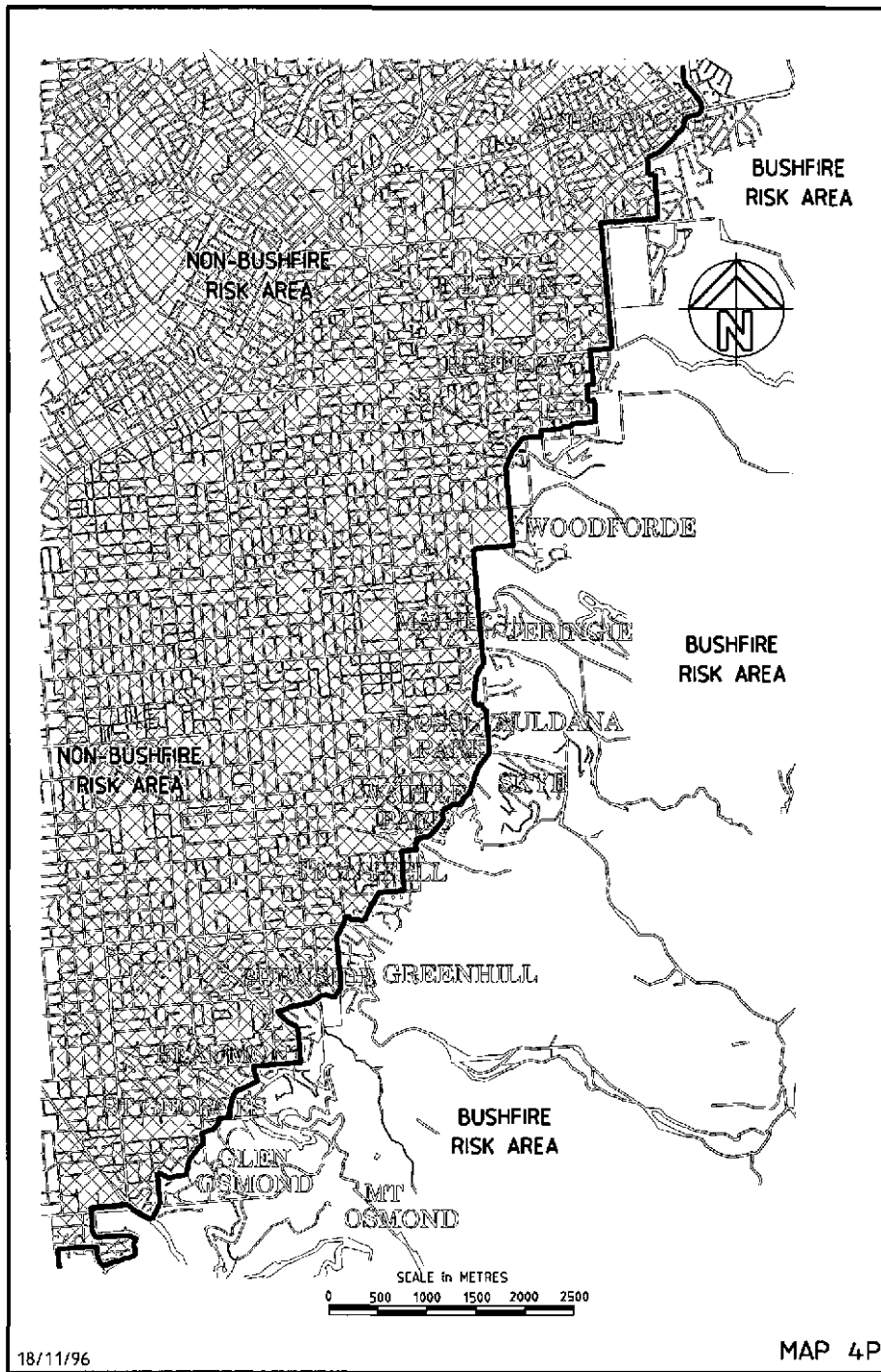

18/11/96

MAP 4P

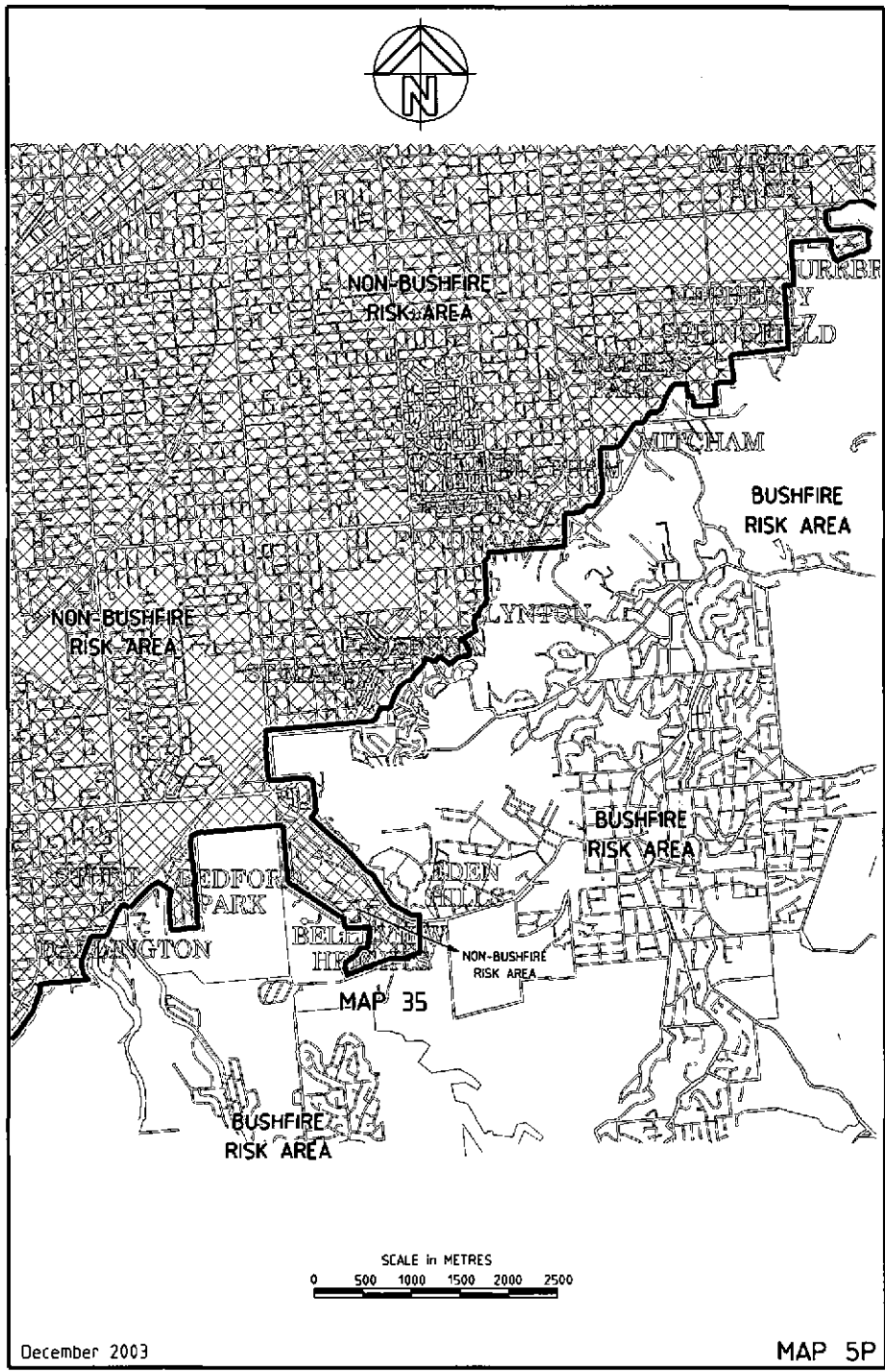

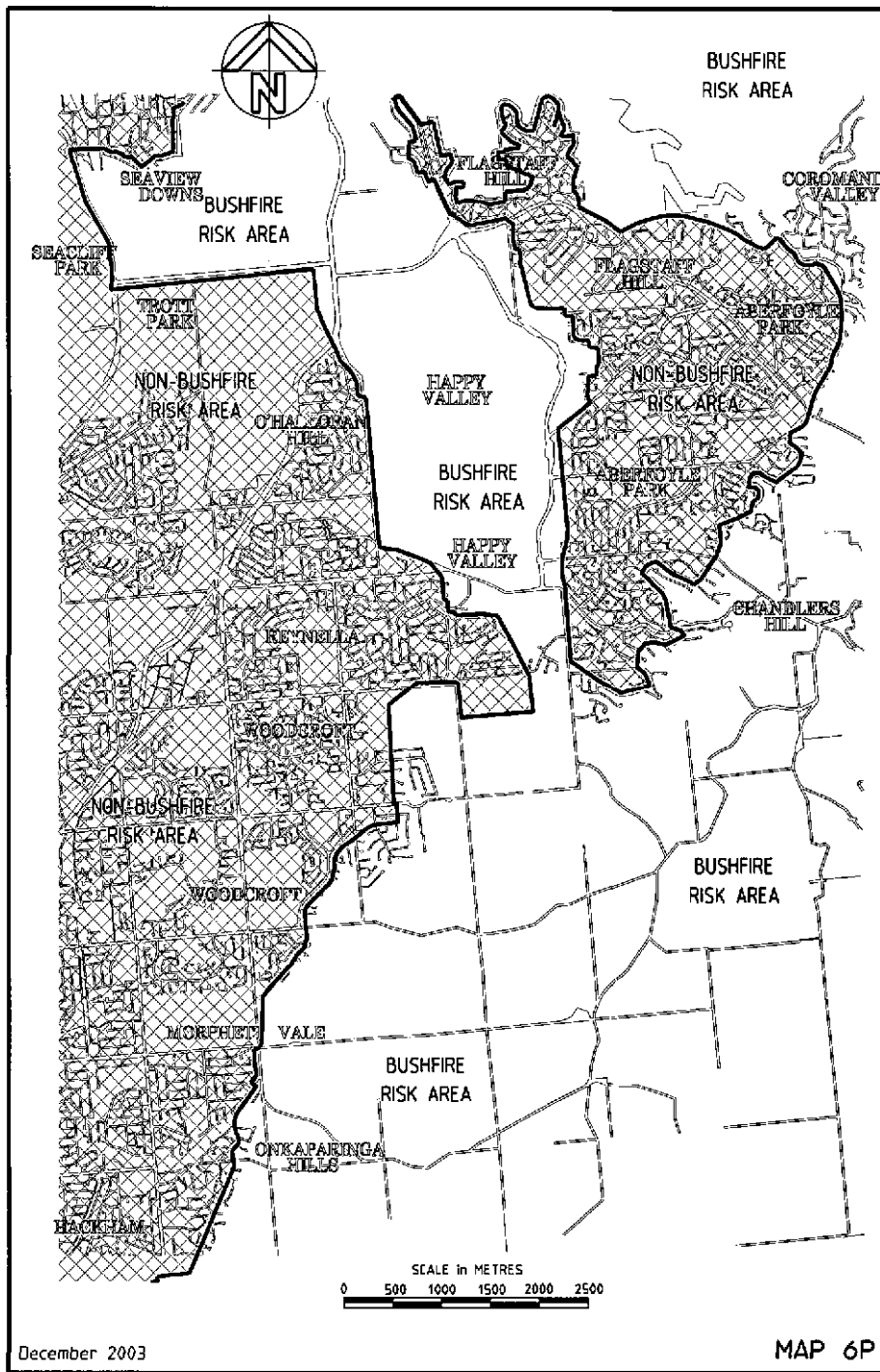

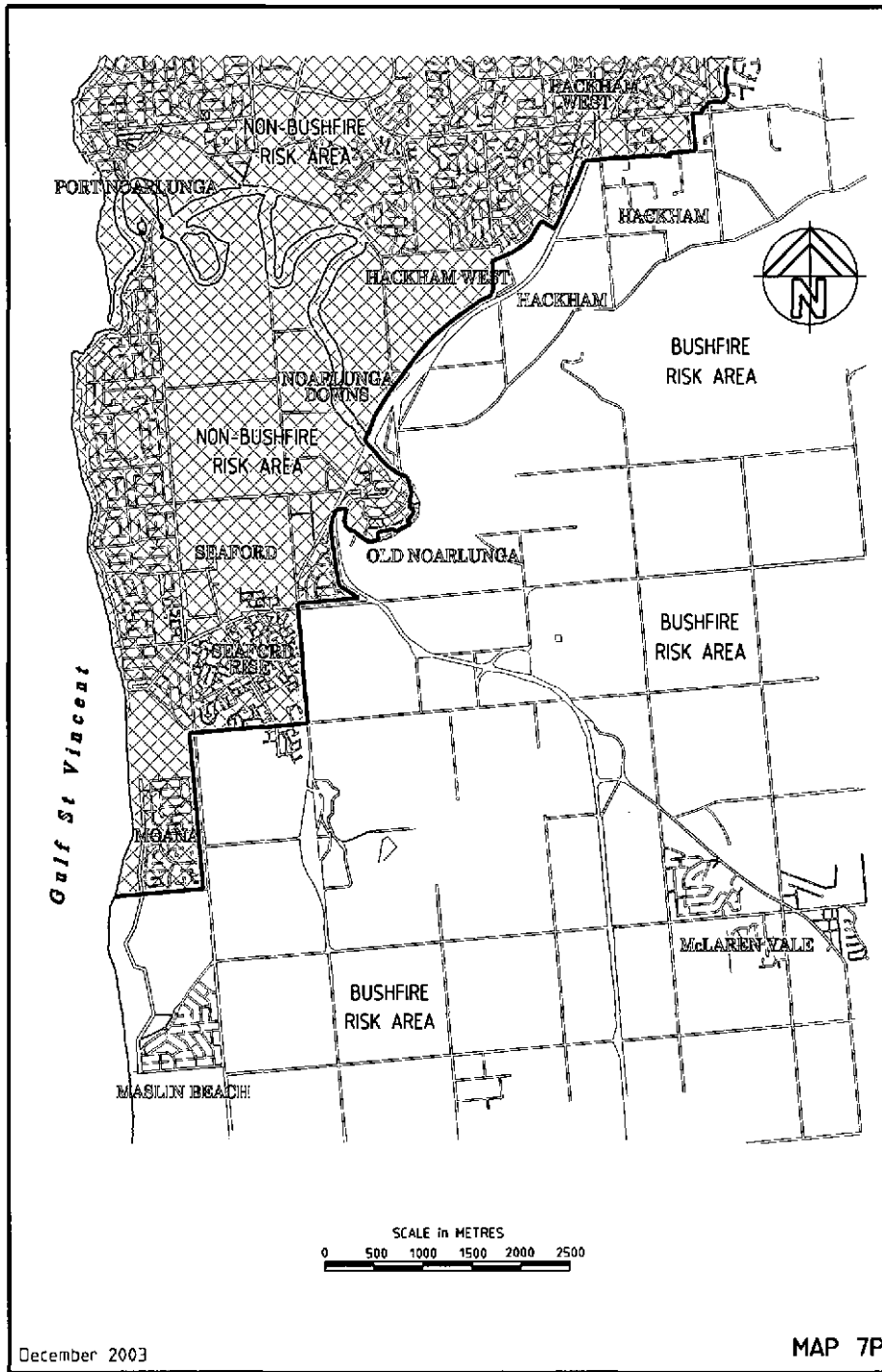

Schedule 4—Maps showing bushfire risk area

The first map shows the general boundaries of the bushfire risk area for the State. The next 8 maps show those boundaries in more detail.

The remaining maps show areas that fall within the general boundaries of the bushfire risk area but which are non-bushfire risk areas. Those maps are presented by district affected, in the following order:

Index to map sheets for portion of Adelaide Metropolitan Area

Metropolitan Adelaide (9 maps)

Ardrossan

Arno Bay

Balaklava

Barossa (2 maps)

Beachport

Blyth

Booleroo Centre

Bordertown

Burra

Bute

Carrickalinga

Ceduna

Clare

Cleve

Coffin Bay

Coobowie

Coonawarra

Cowell

Crystal Brook

Cummins

Edithburgh

Elliston

Eudunda

Eyre Peninsula East Coast (7 maps)

Fishermans Bay

Freeling

Gawler River (2 maps)

Gladstone

Goolwa

Greenock

Hahndorf

Hamley Bridge

Hawker

Jamestown

Kadina

Kalangadoo

Kapunda

Keith

Kimba

Kingscote

Kingston S.E.

Laura

Littlehampton
Lobethal
Lock
Loxton
Lyndoch
Maitland
Mallala
Mannum
Meningie
Middleton
Milang
Millicent
Minlaton
Minnipa
Moonta
Moonta Bay
Mount Barker
Mount Gambier (2 maps)
Murray Bridge
Mypolonga
Nangwarry
Naracoorte
Nora Creina
Normanville
Orroroo
Parachilna
Penneshaw
Penola
Peterborough
Ponde
Port Broughton
Port Elliot
Port Hughes
Port Lincoln
Port MacDonnell
Port Moorowie
Port Vincent
Port Wakefield
Port Wakefield coastline (3 maps)
Punyleroo
Quorn
Riverland (6 maps)
Riverton
Robe
Saddleworth
Smoky Bay
Snowtown
South End
Spalding
Stirling North
Strathalbyn
Streaky Bay

Tailem Bend
Tantanoola
Teal Flat
Terowie
Tiddy Widdy Beach
Tumby Bay
Two Wells
Venus Bay
Victor Harbor (2 maps)
Walker Flat
Wallaroo
Warooka
Woodside
Wool Bay
Wudinna
Yorke Peninsula East Coast (5 maps)
Yorketown

Portion of South Australia

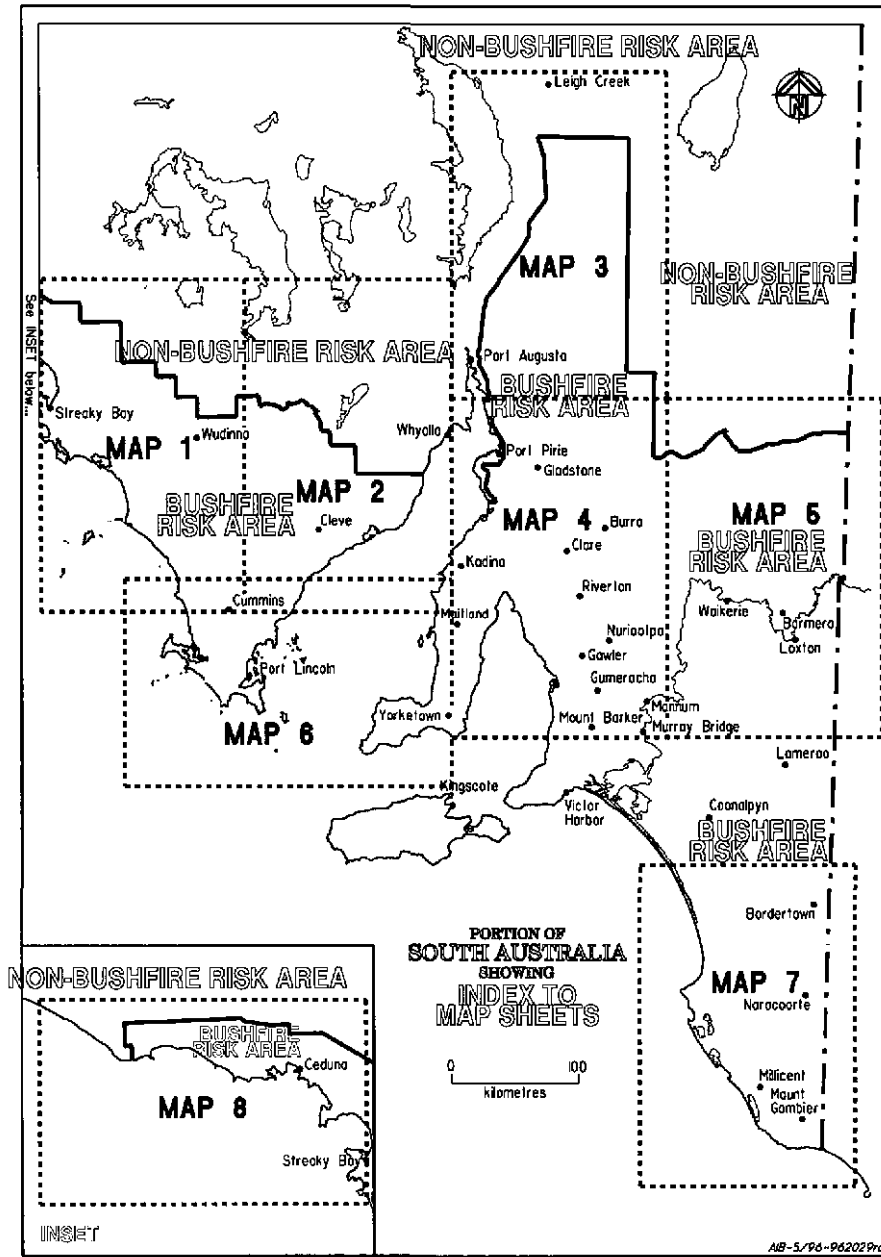

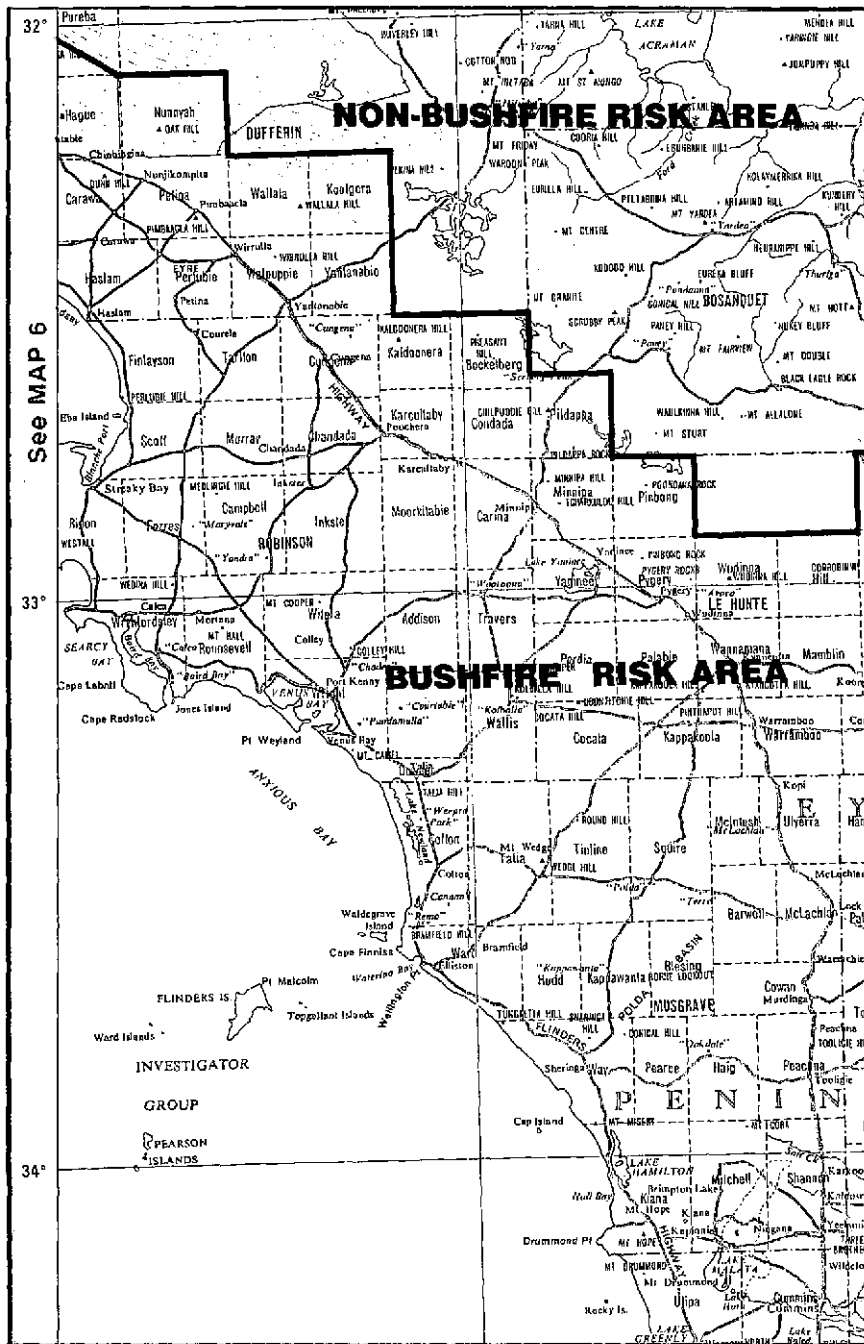

MAP 1

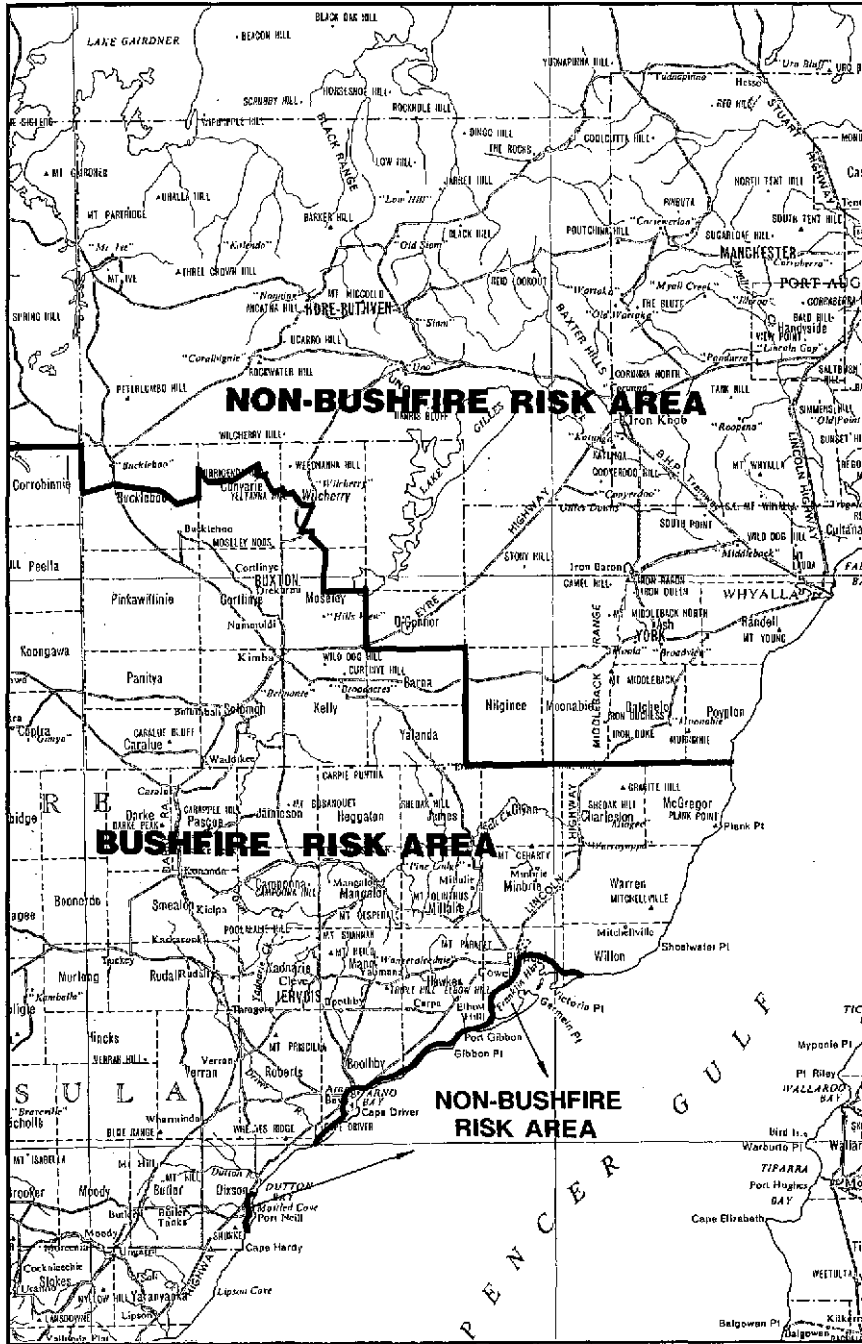

50 kilometres

MAP 2

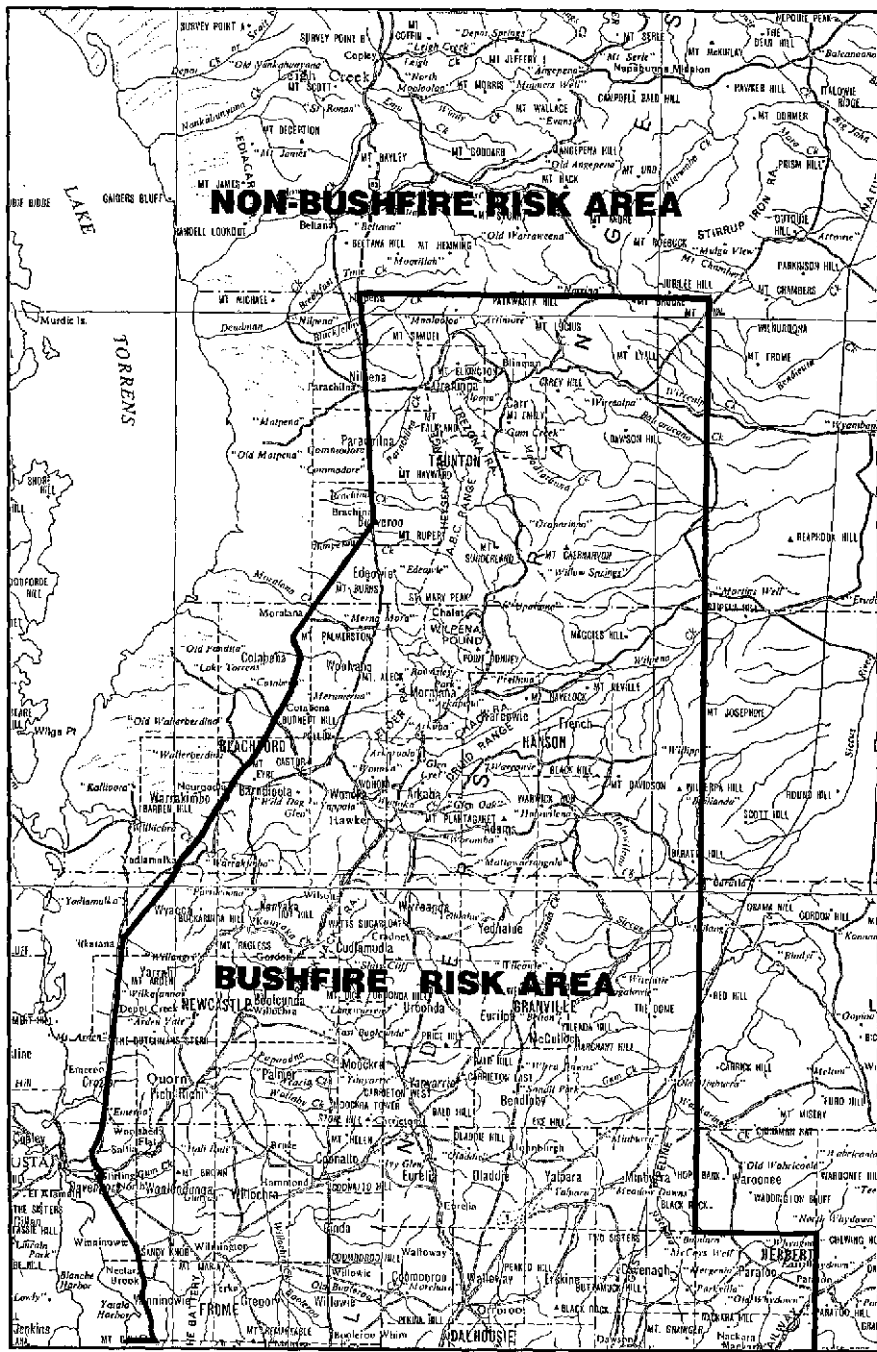

50 kilometres

MAP 3

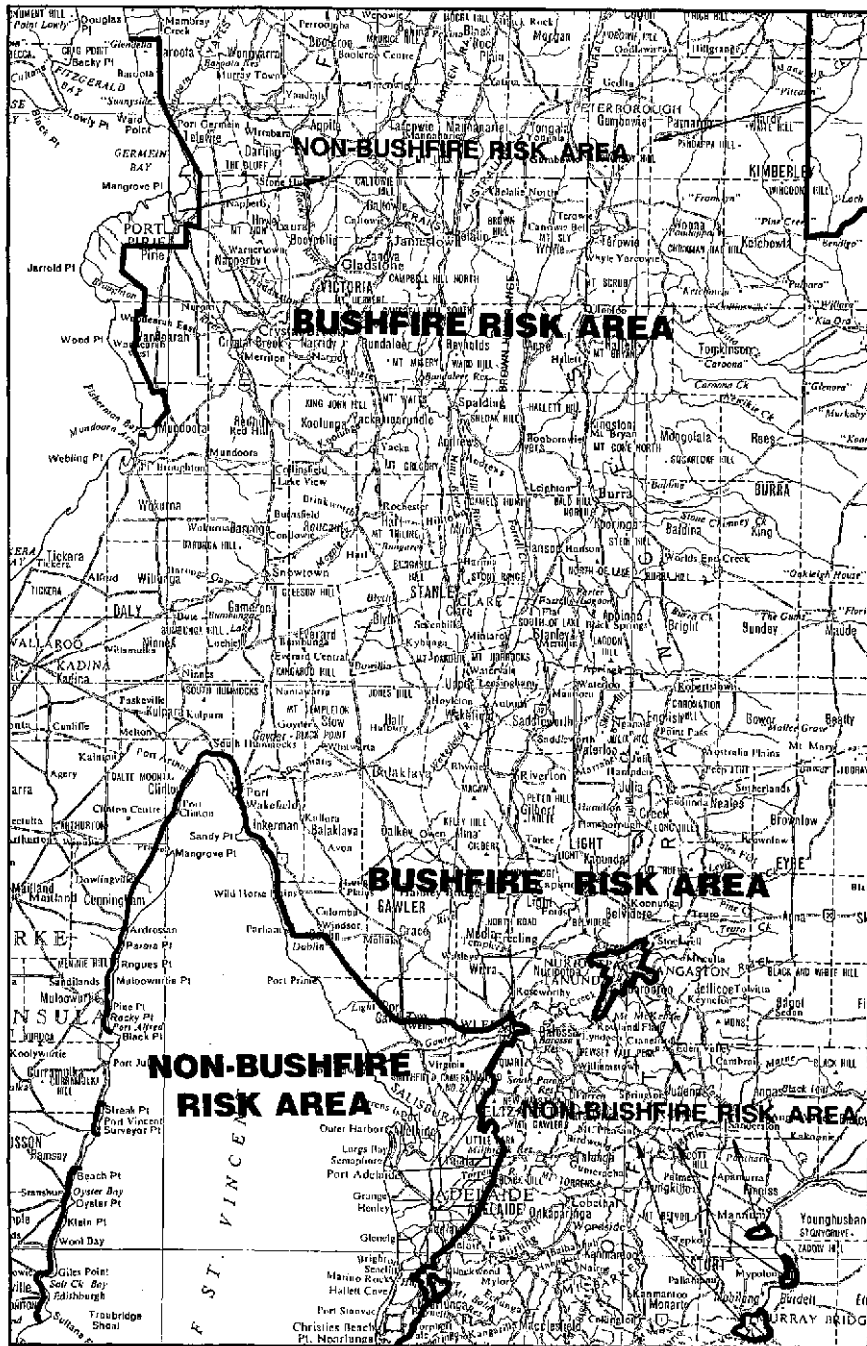

50 kilometres

MAP 4

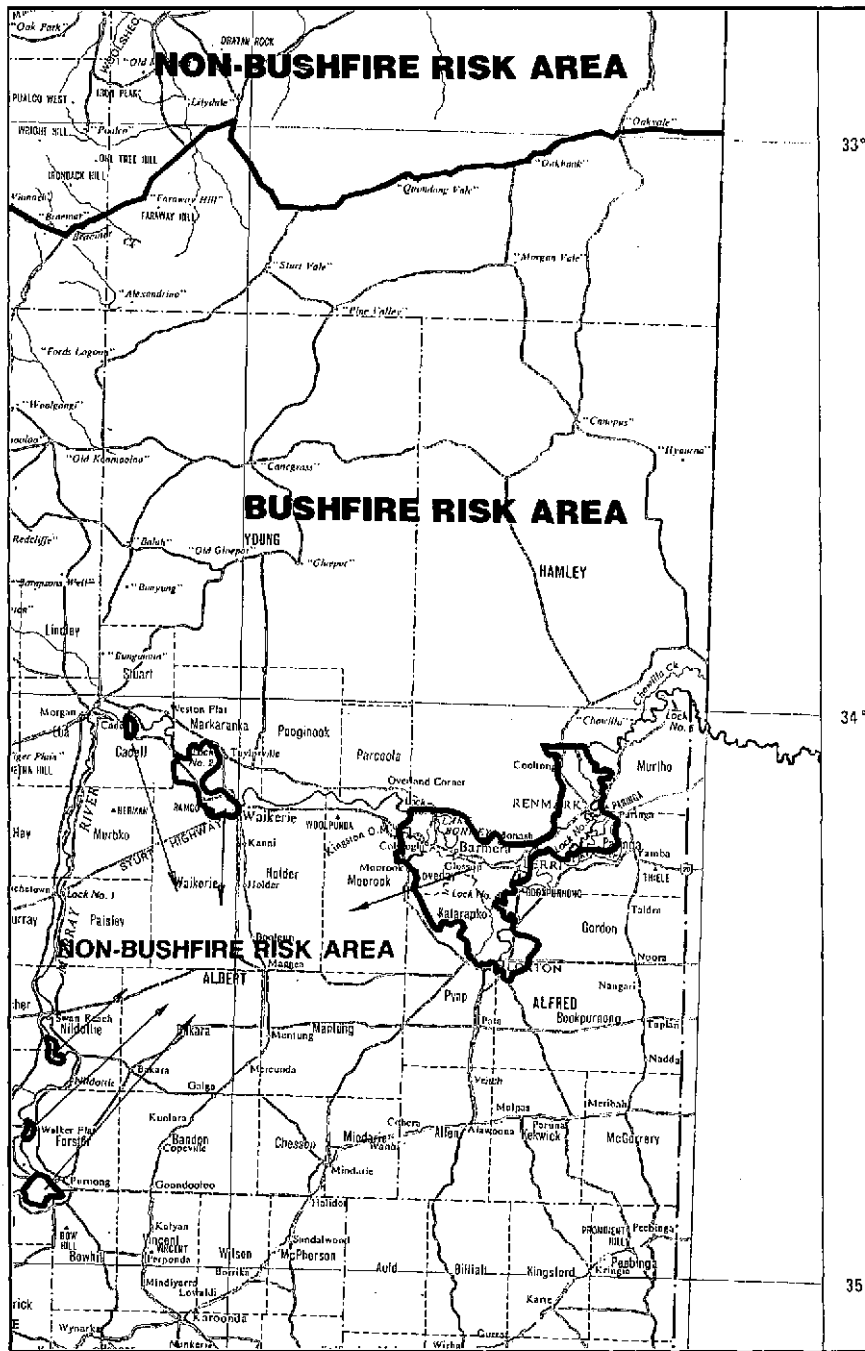

MAP 5

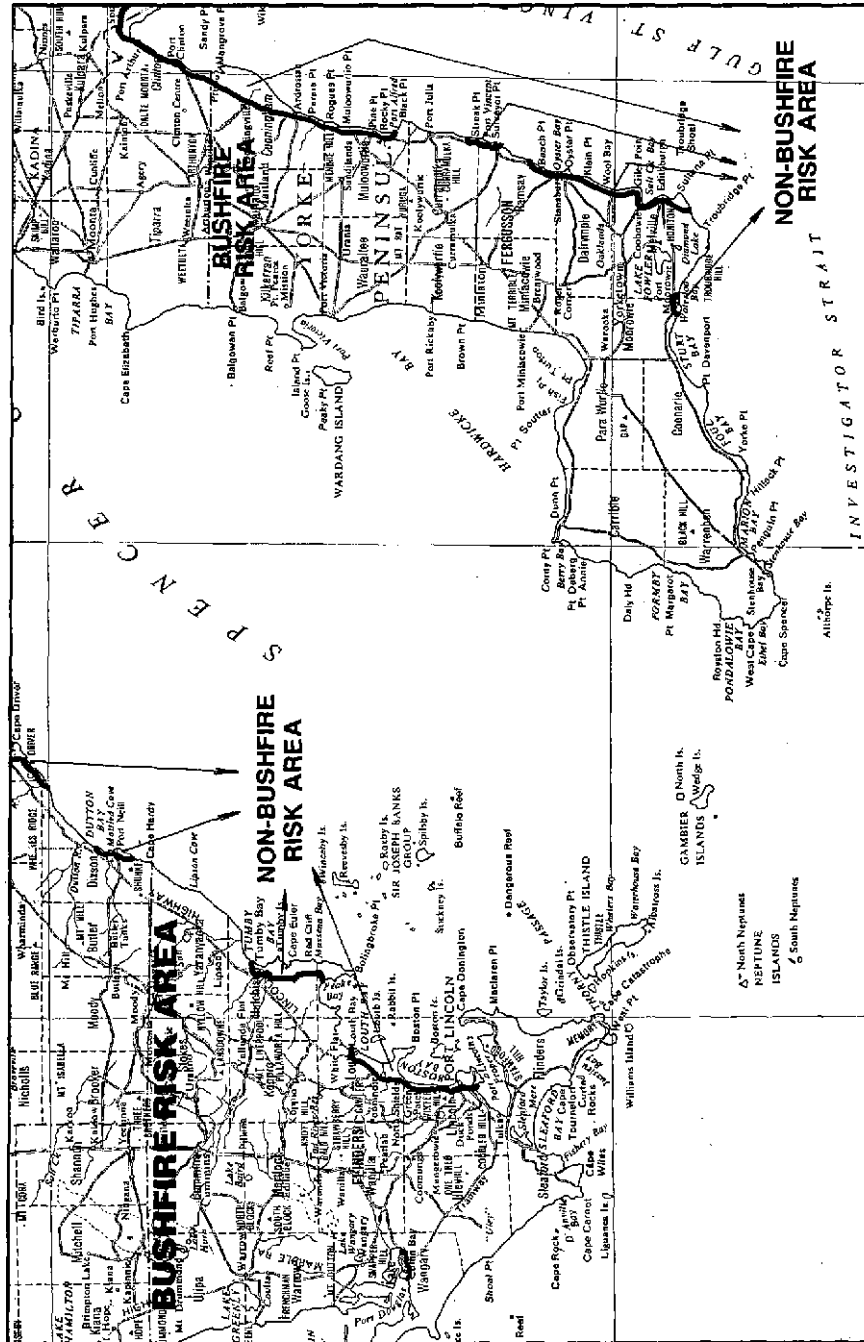

MAP 6

50 kilometres

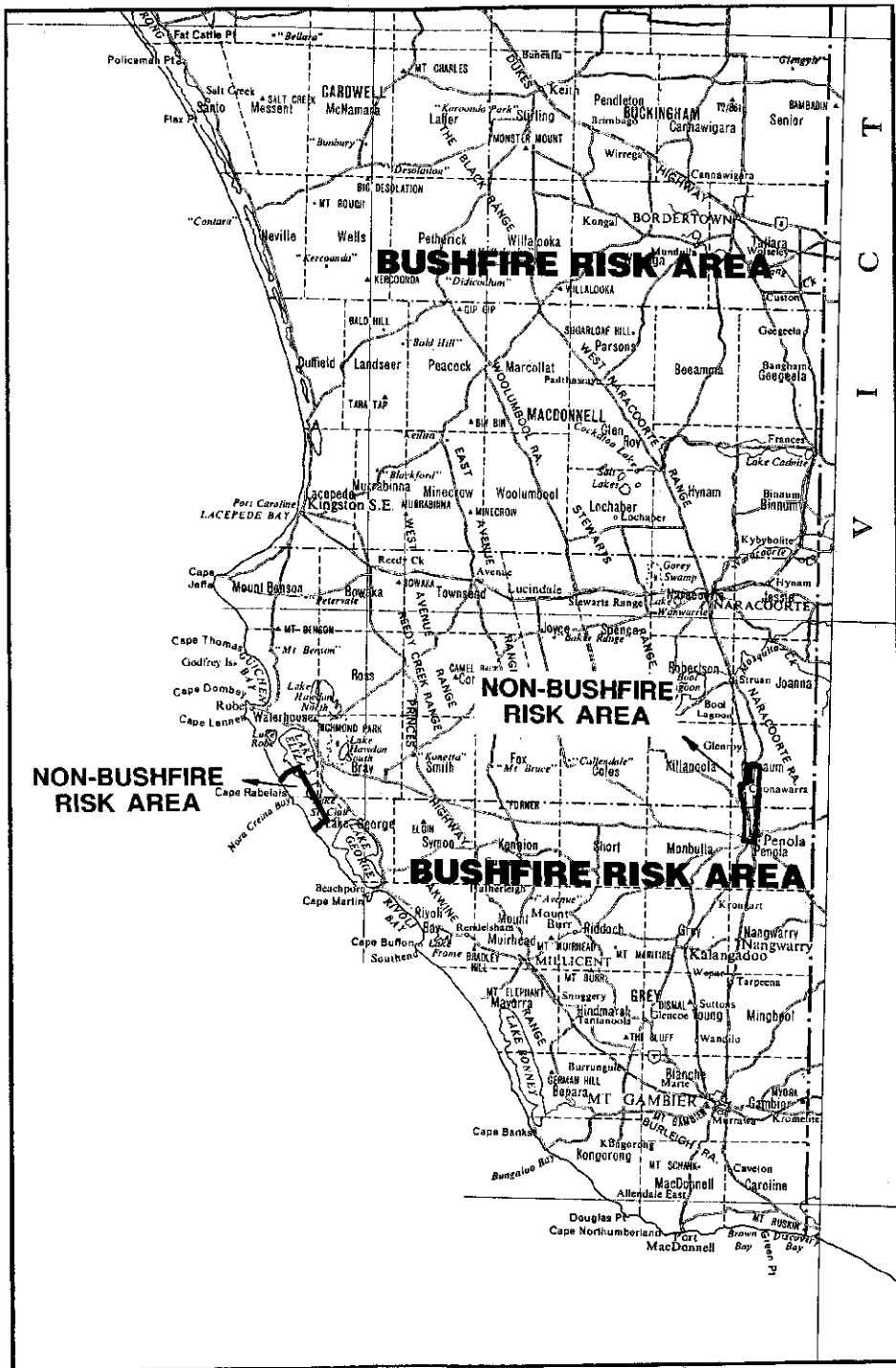

MAP 7

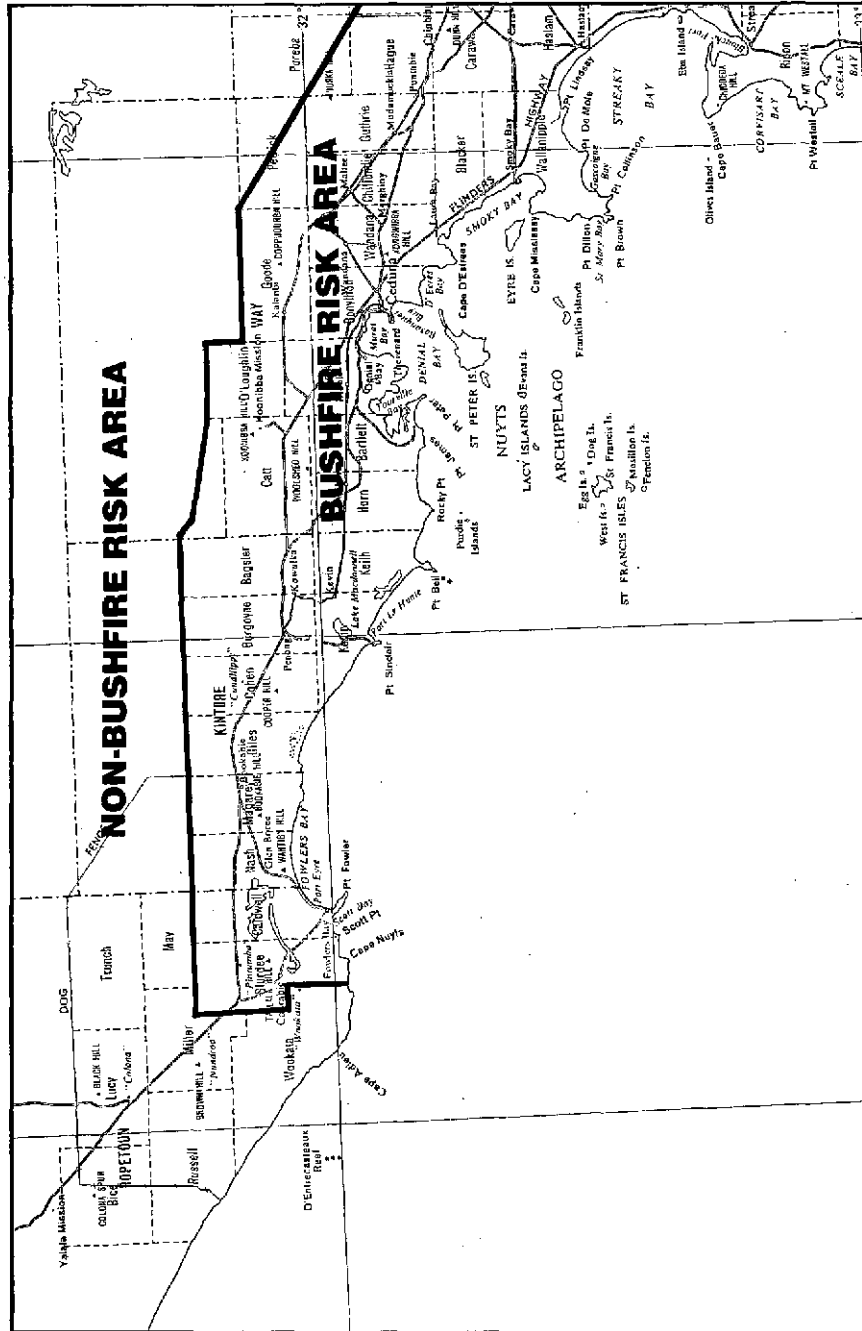

MAP 8

50 kilometres

Portion of Adelaide Metropolitan Area

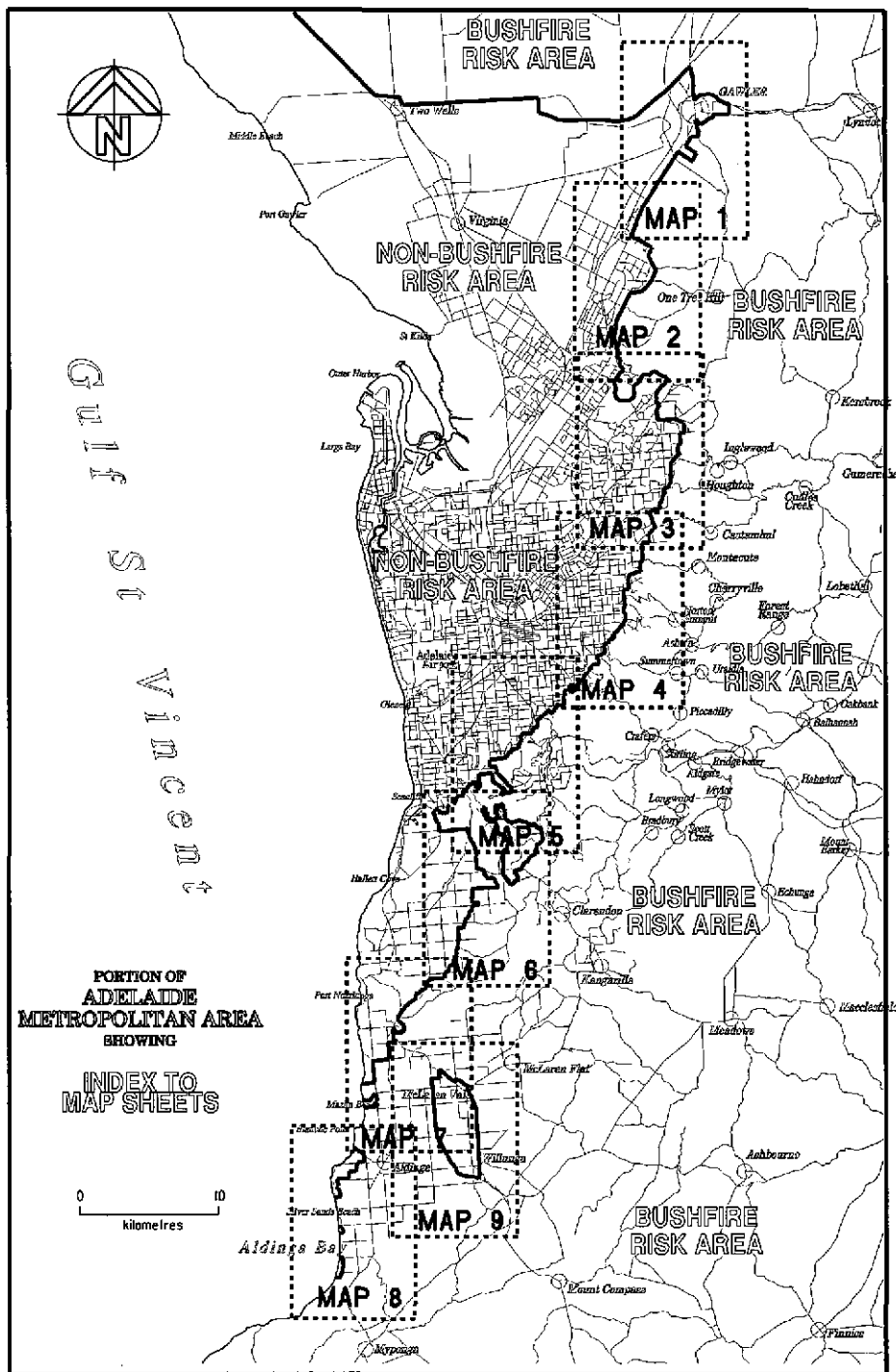

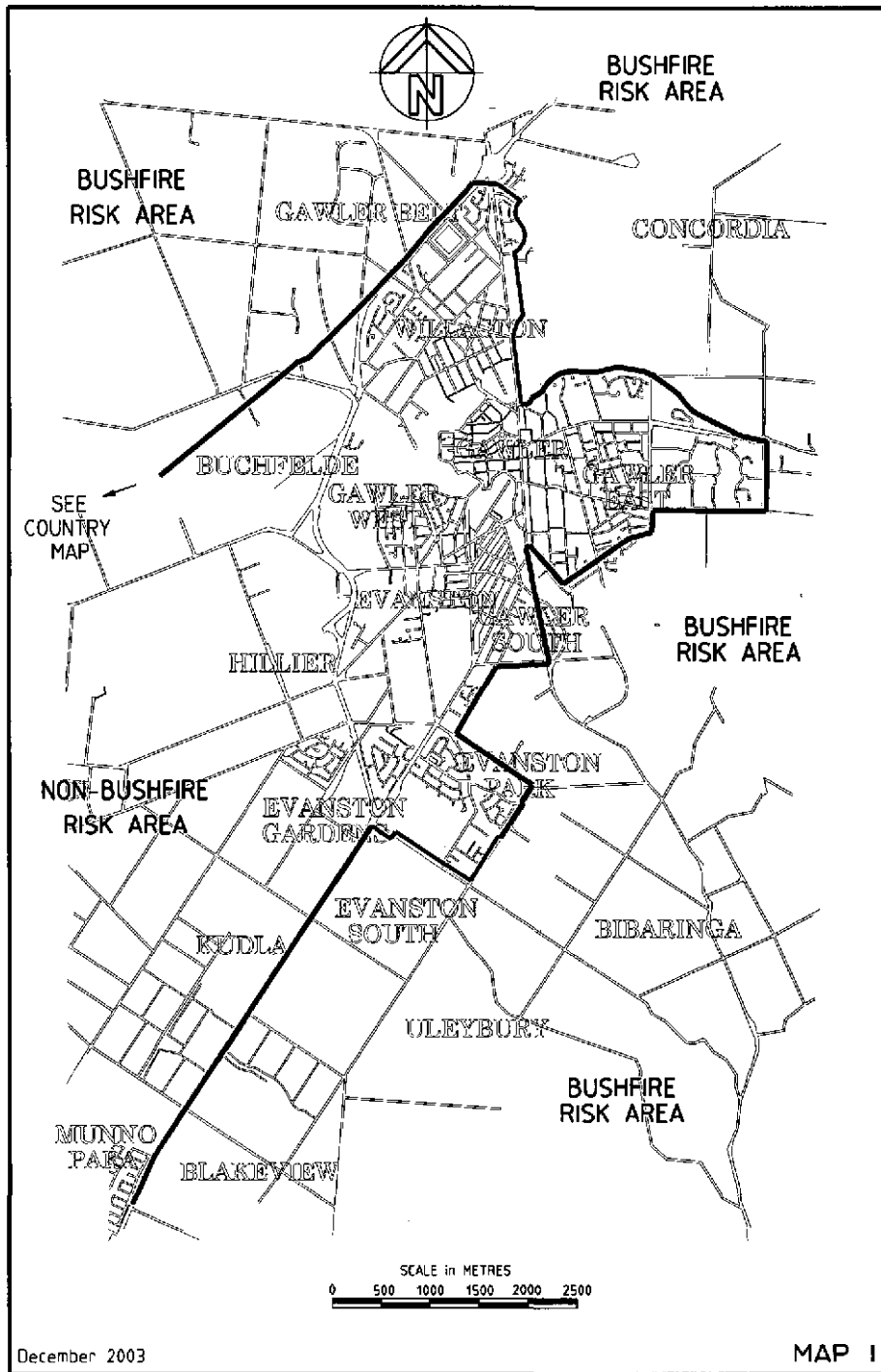

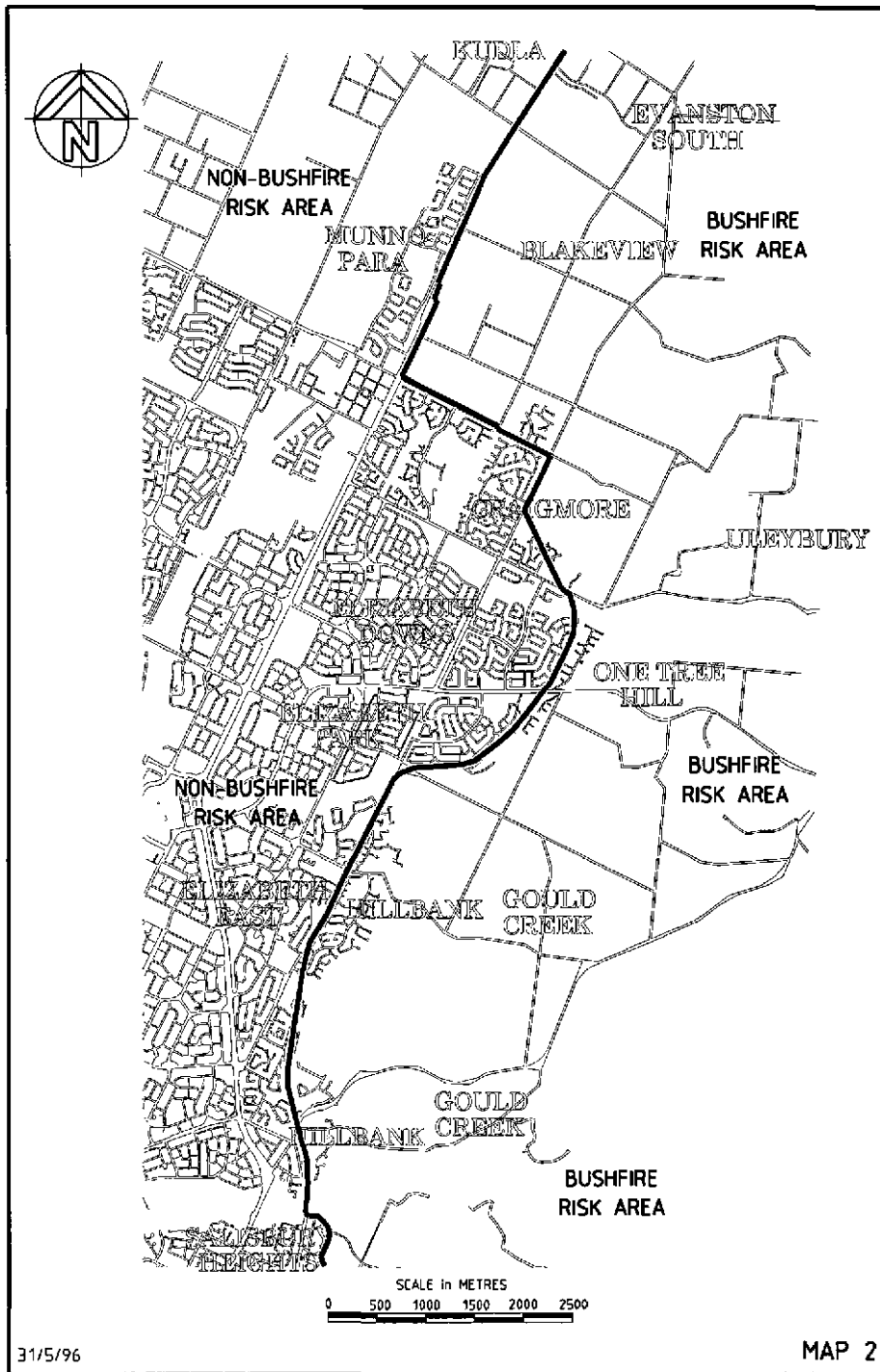

31/5/96

MAP 2

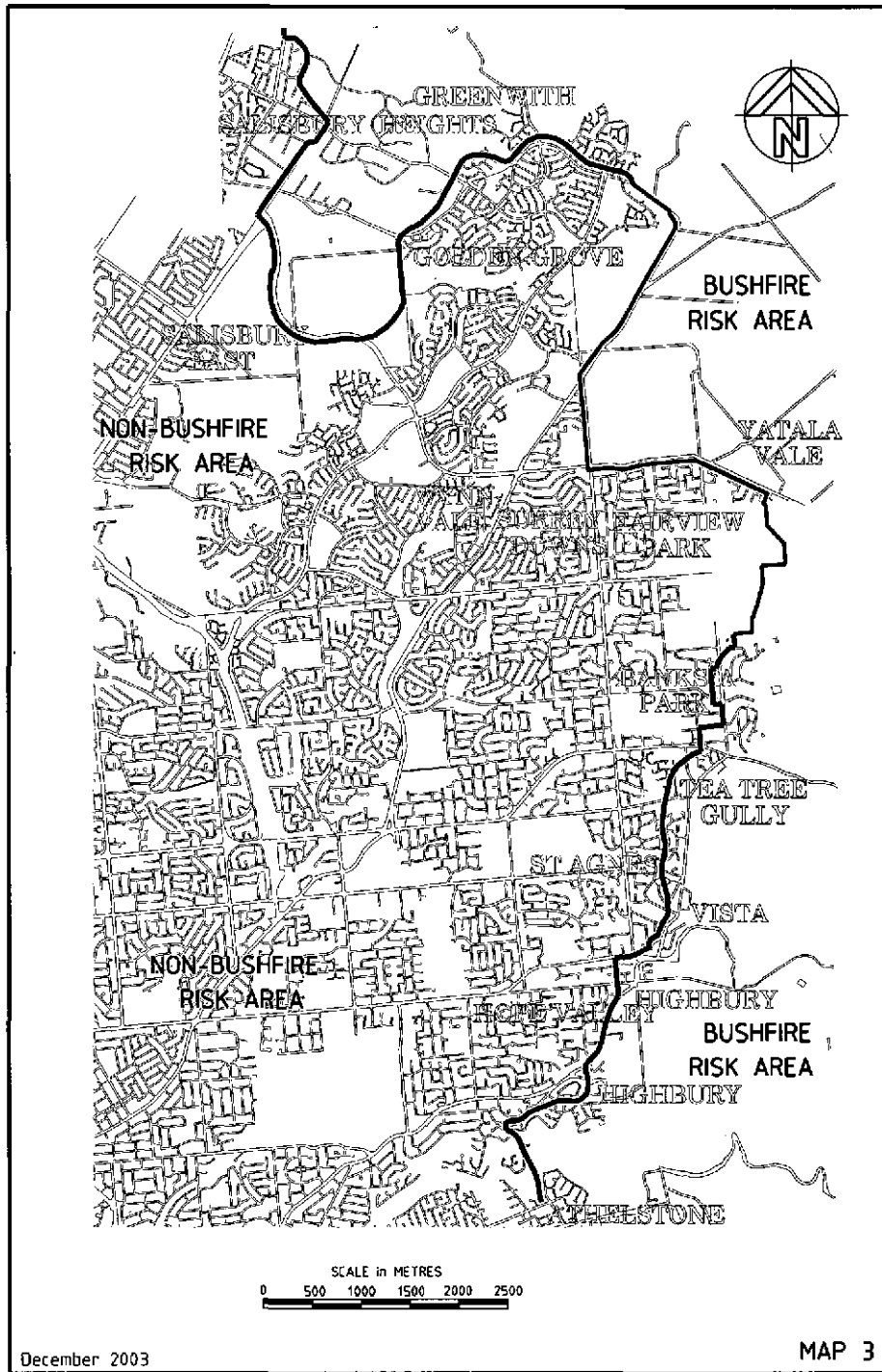

December 2003

MAP 3

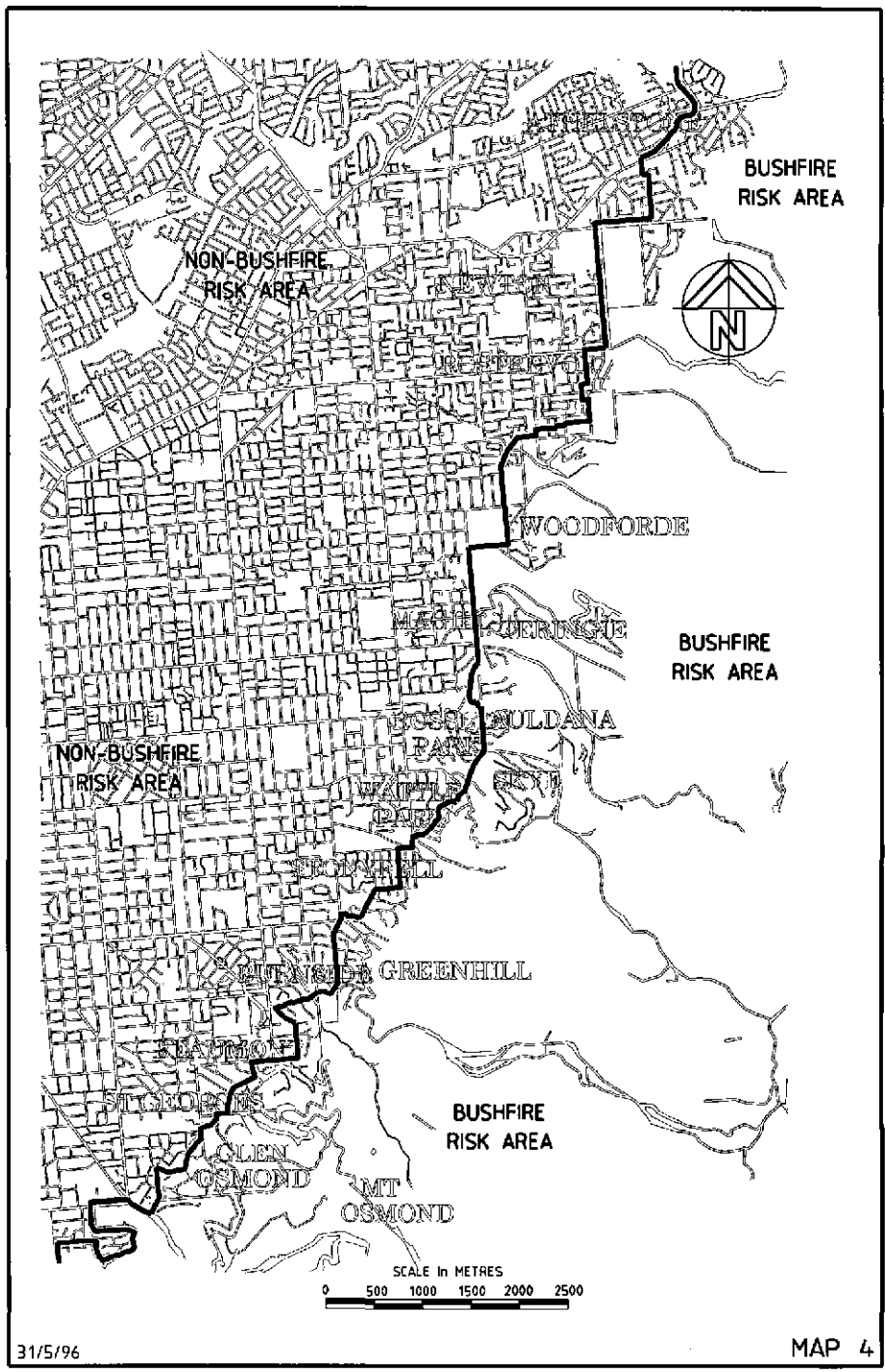

31/5/96

MAP 4

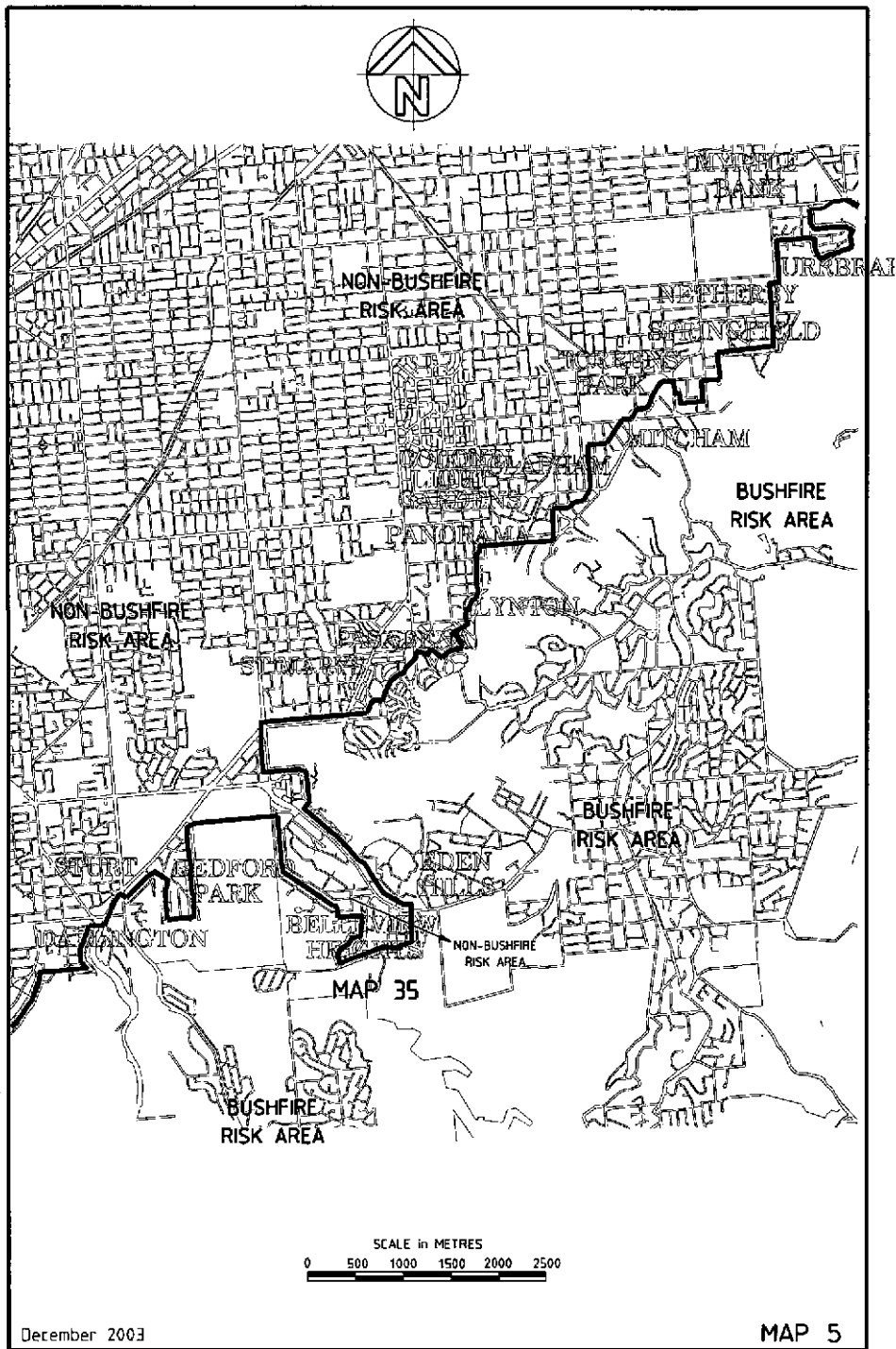

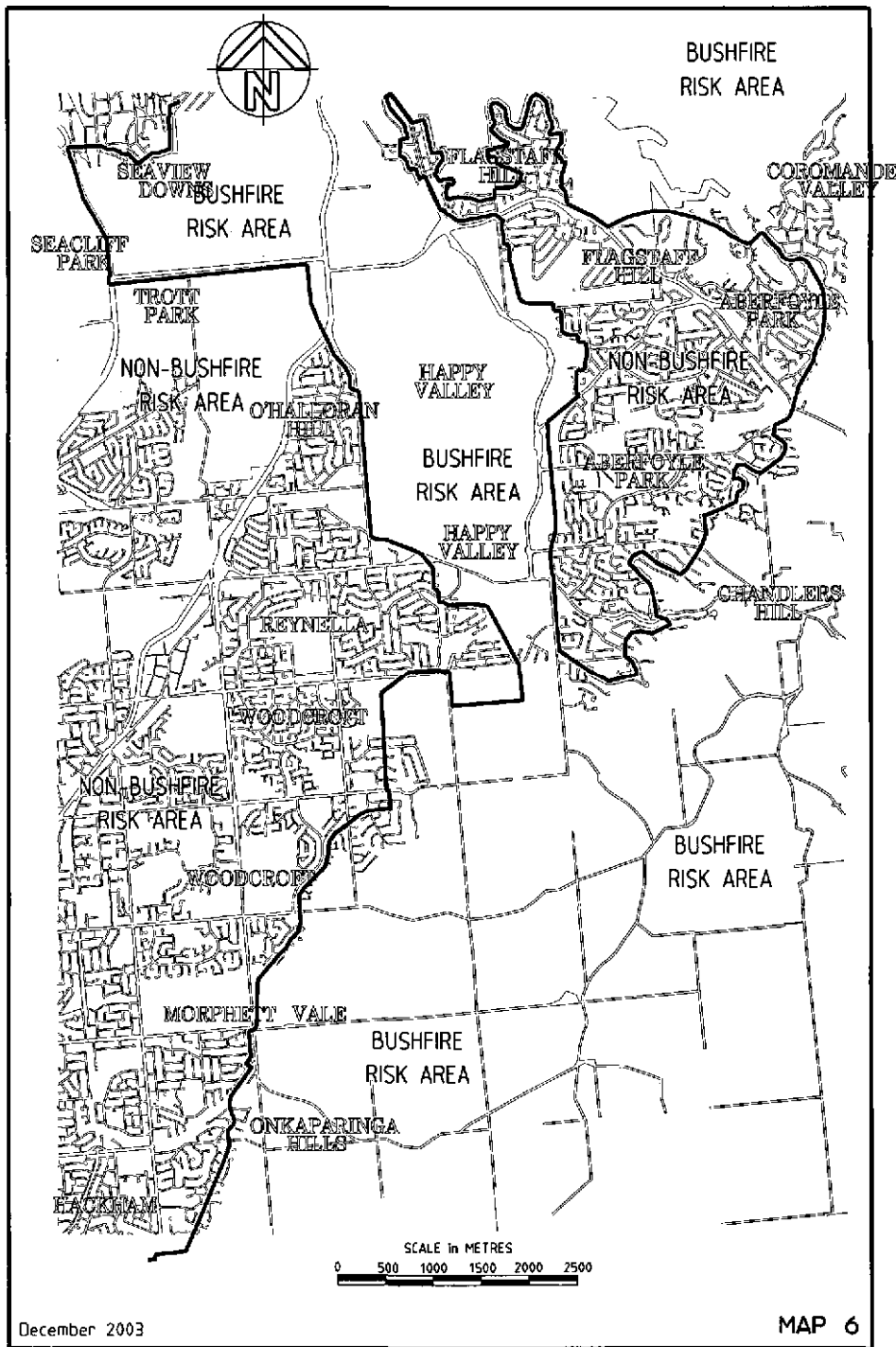

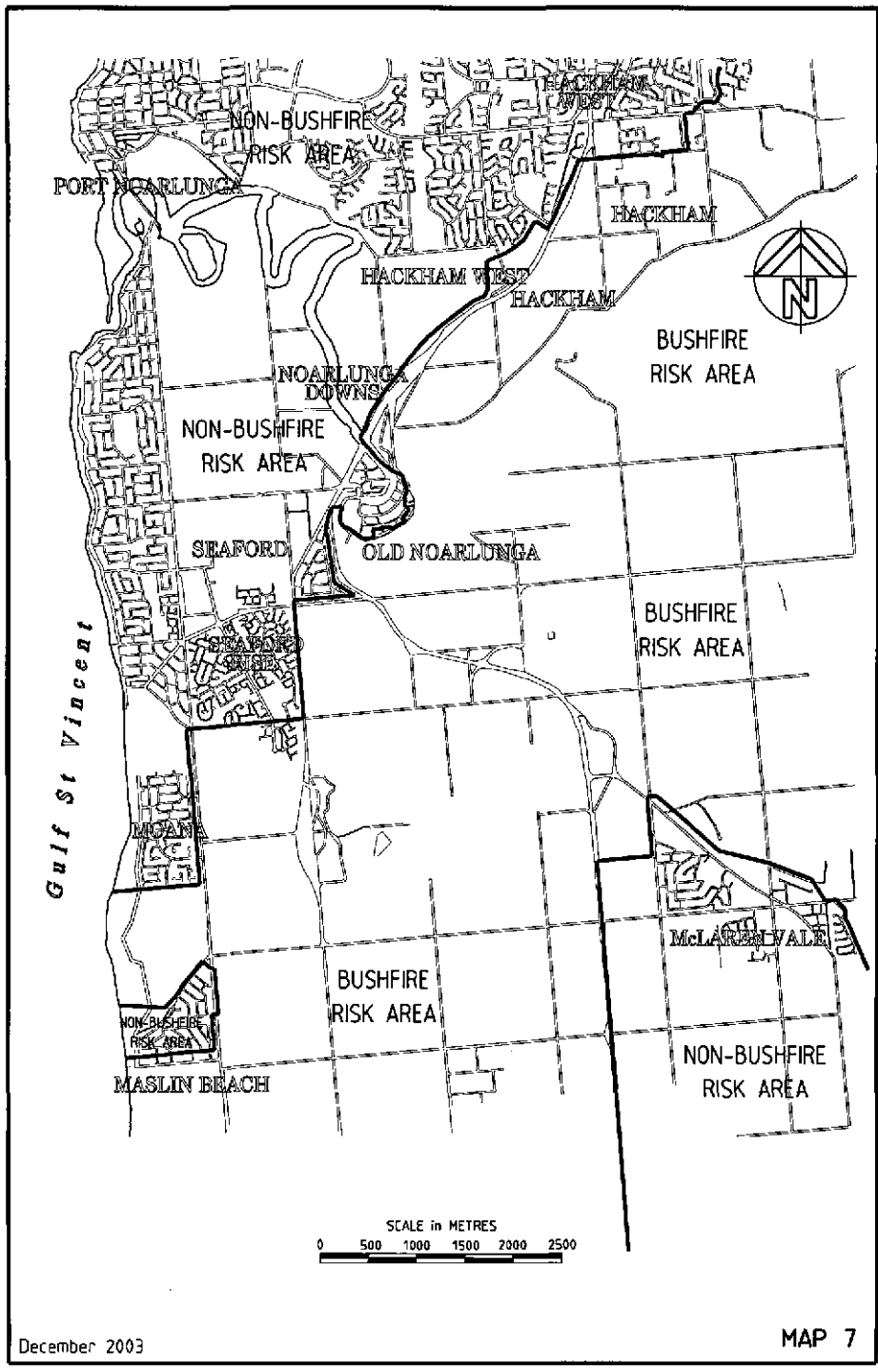

December 2003

MAP 7

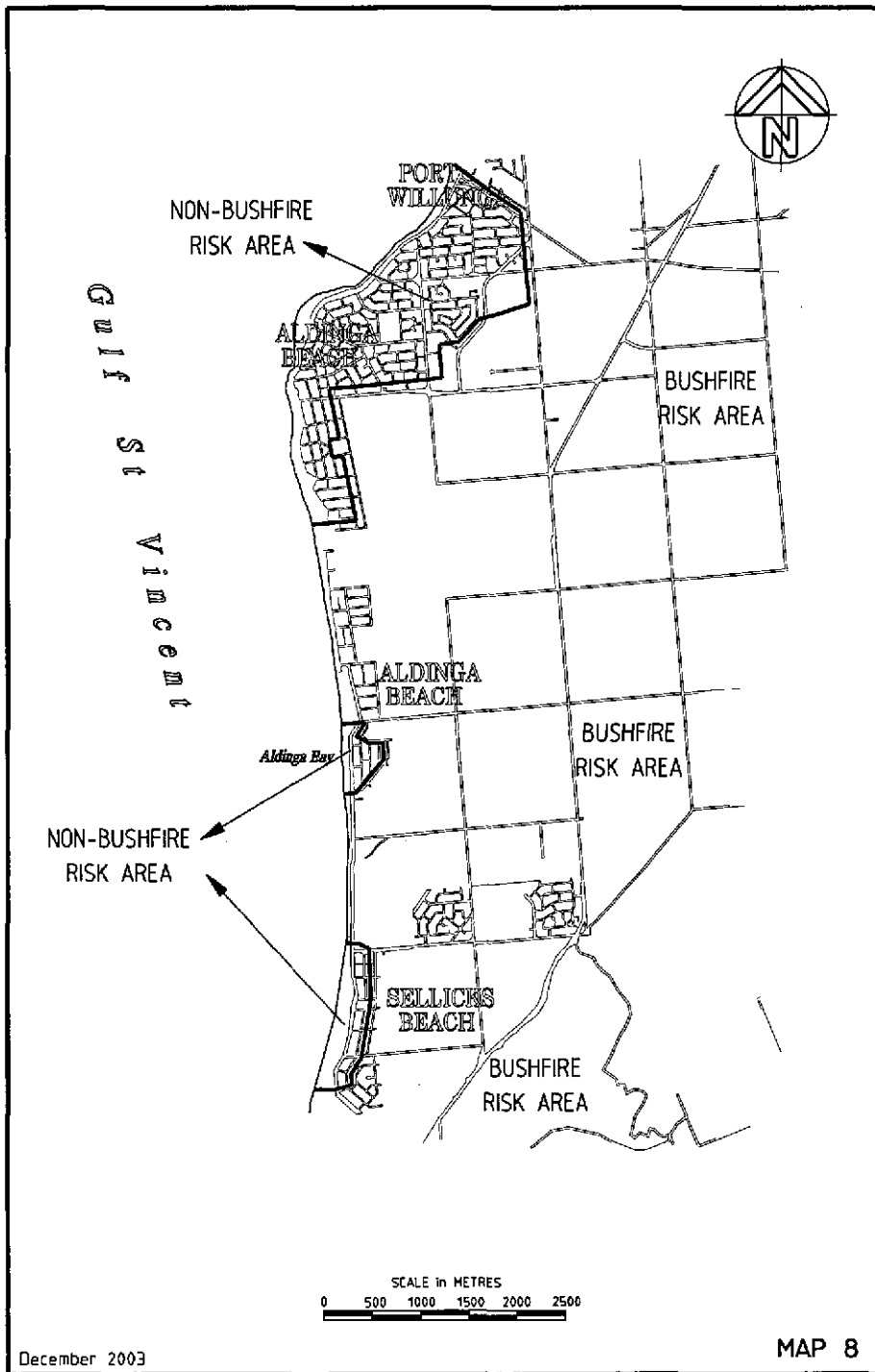

December 2003

MAP 8

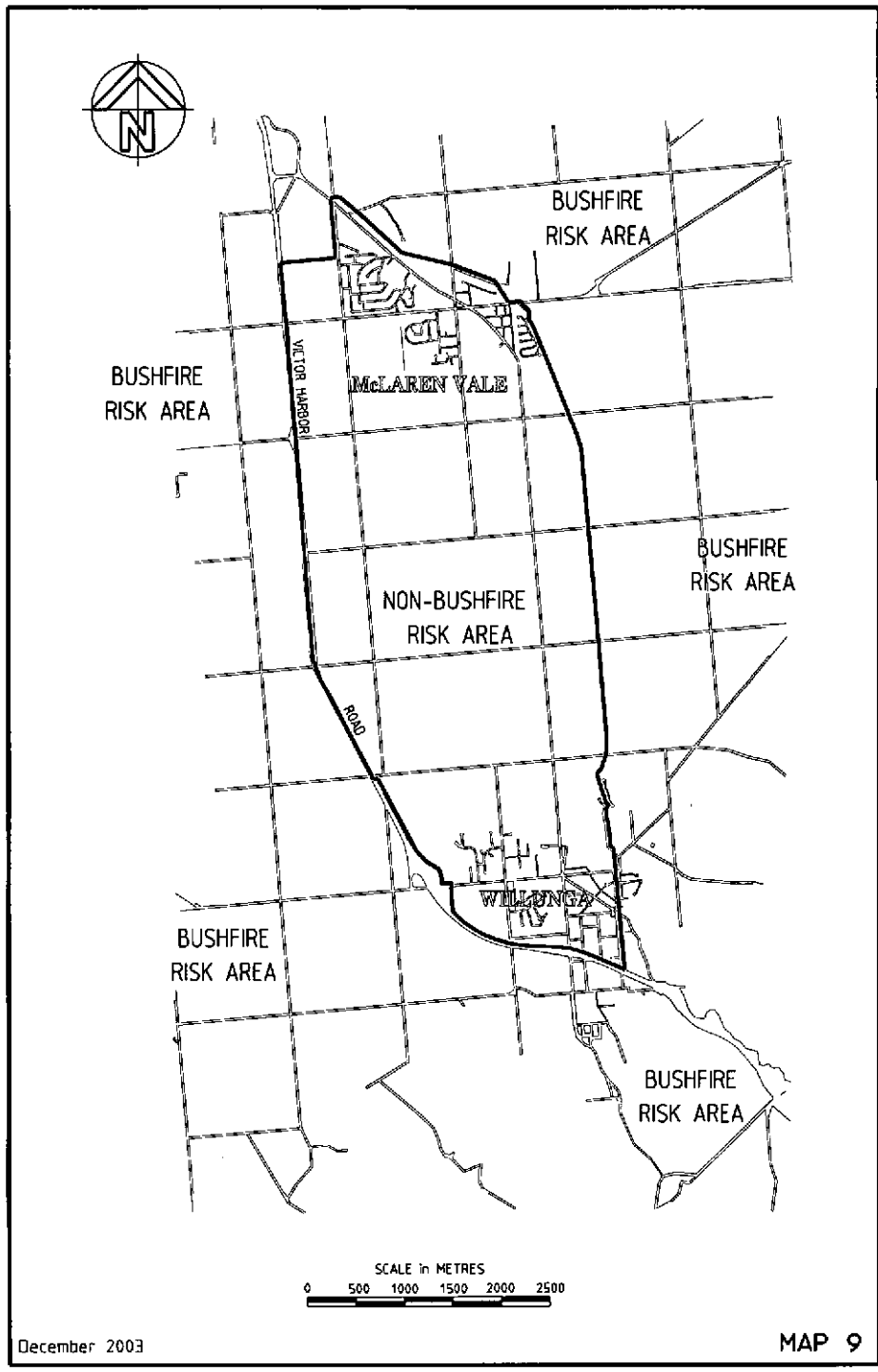

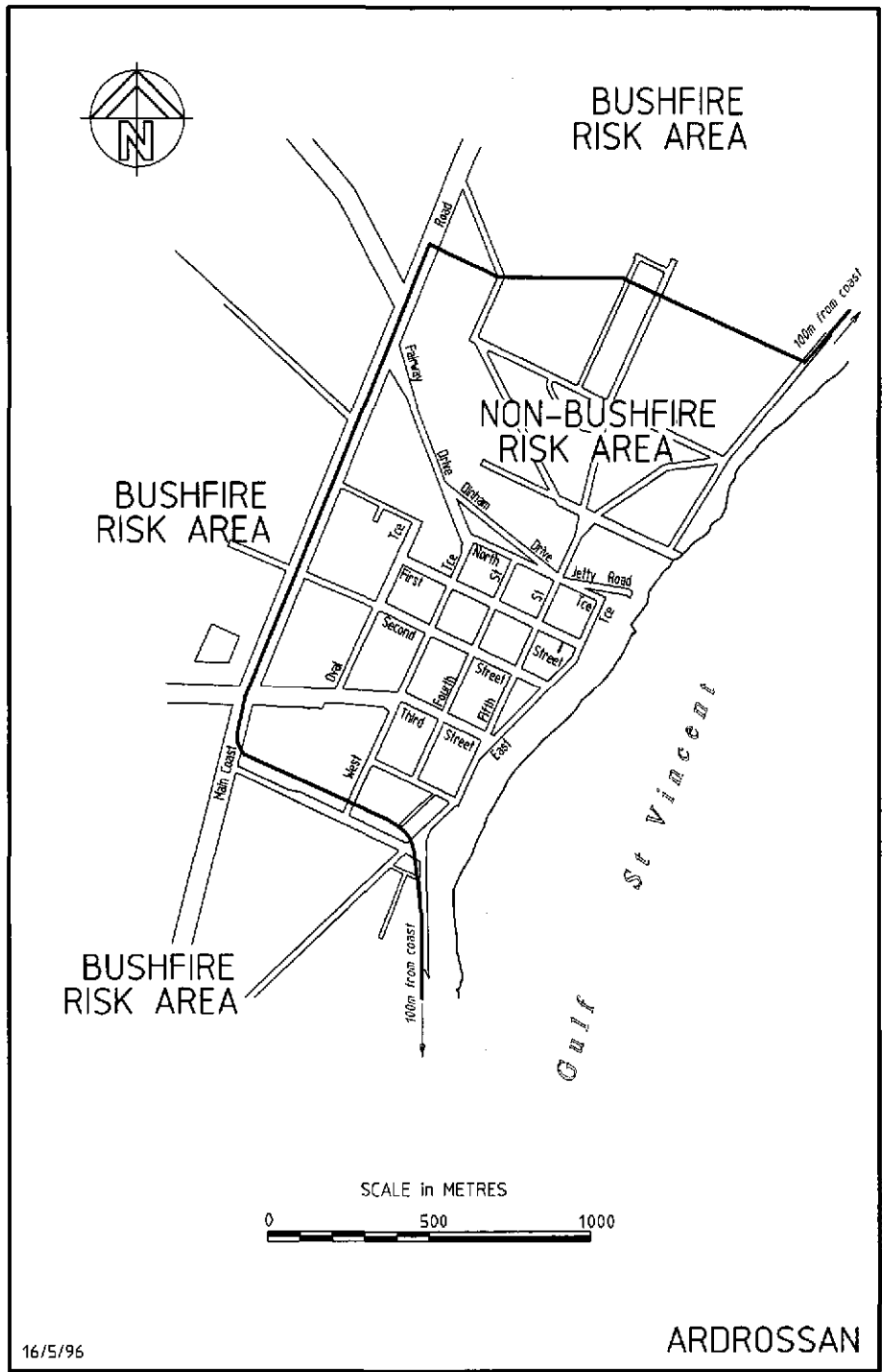

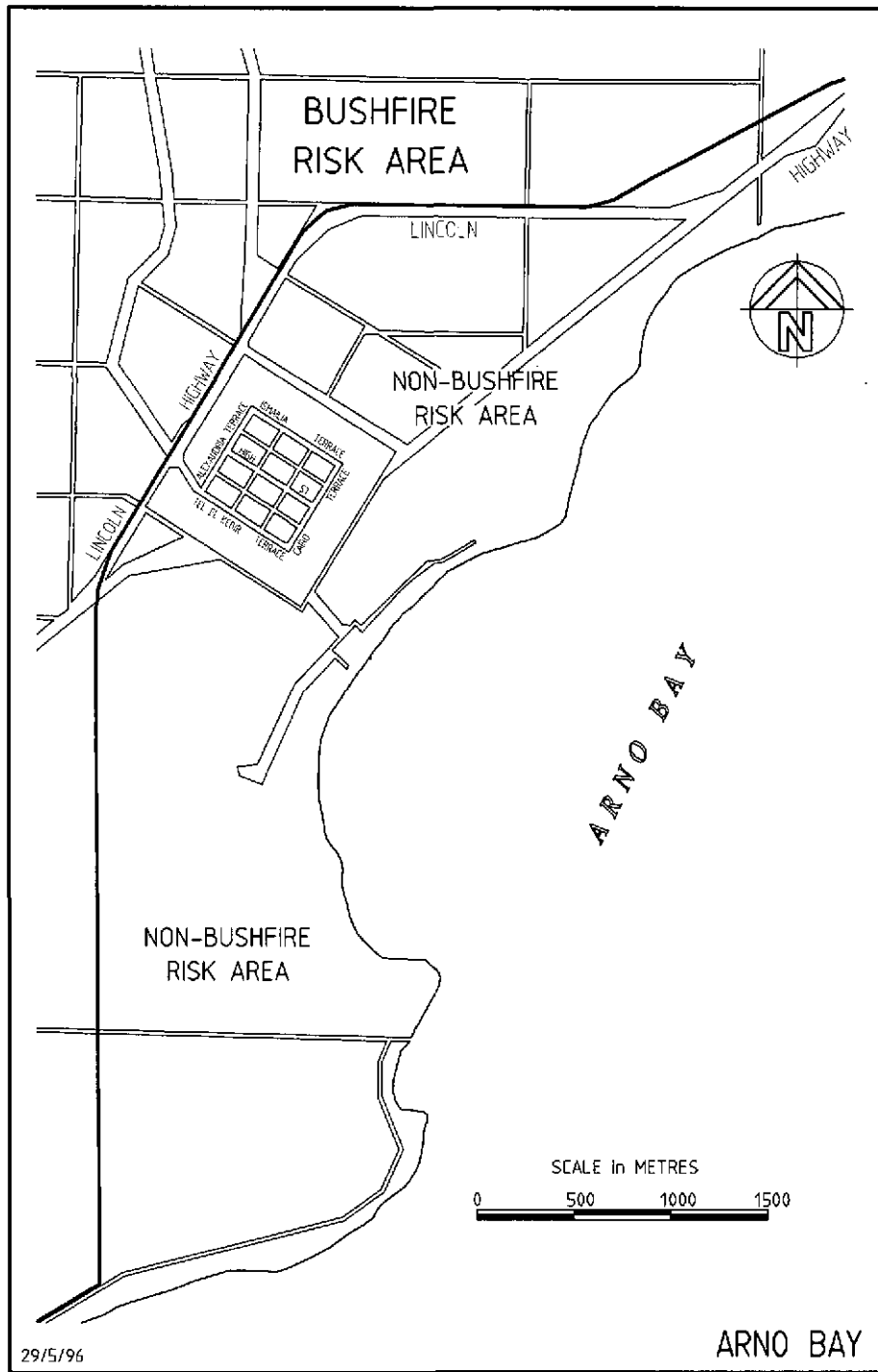

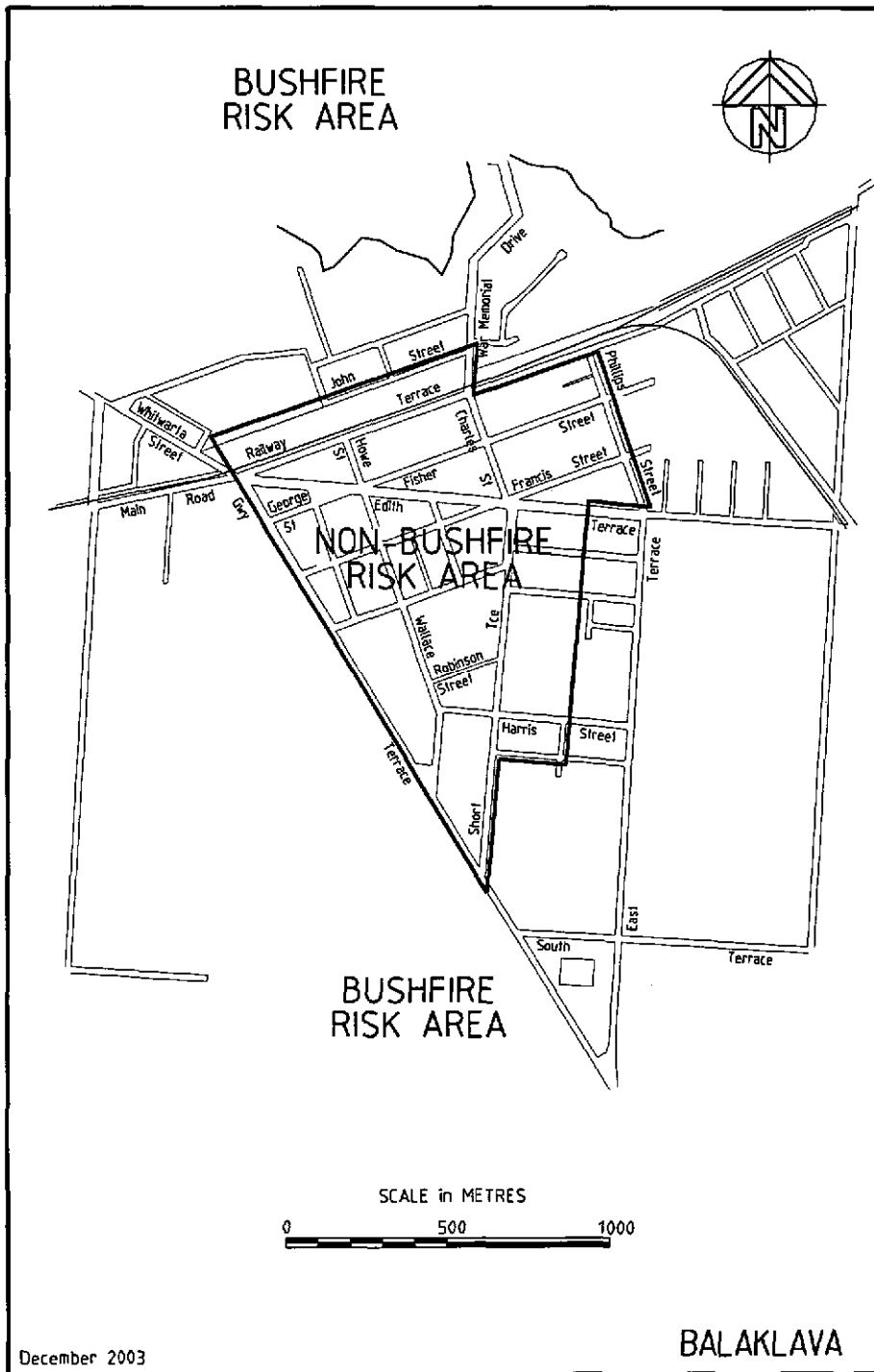

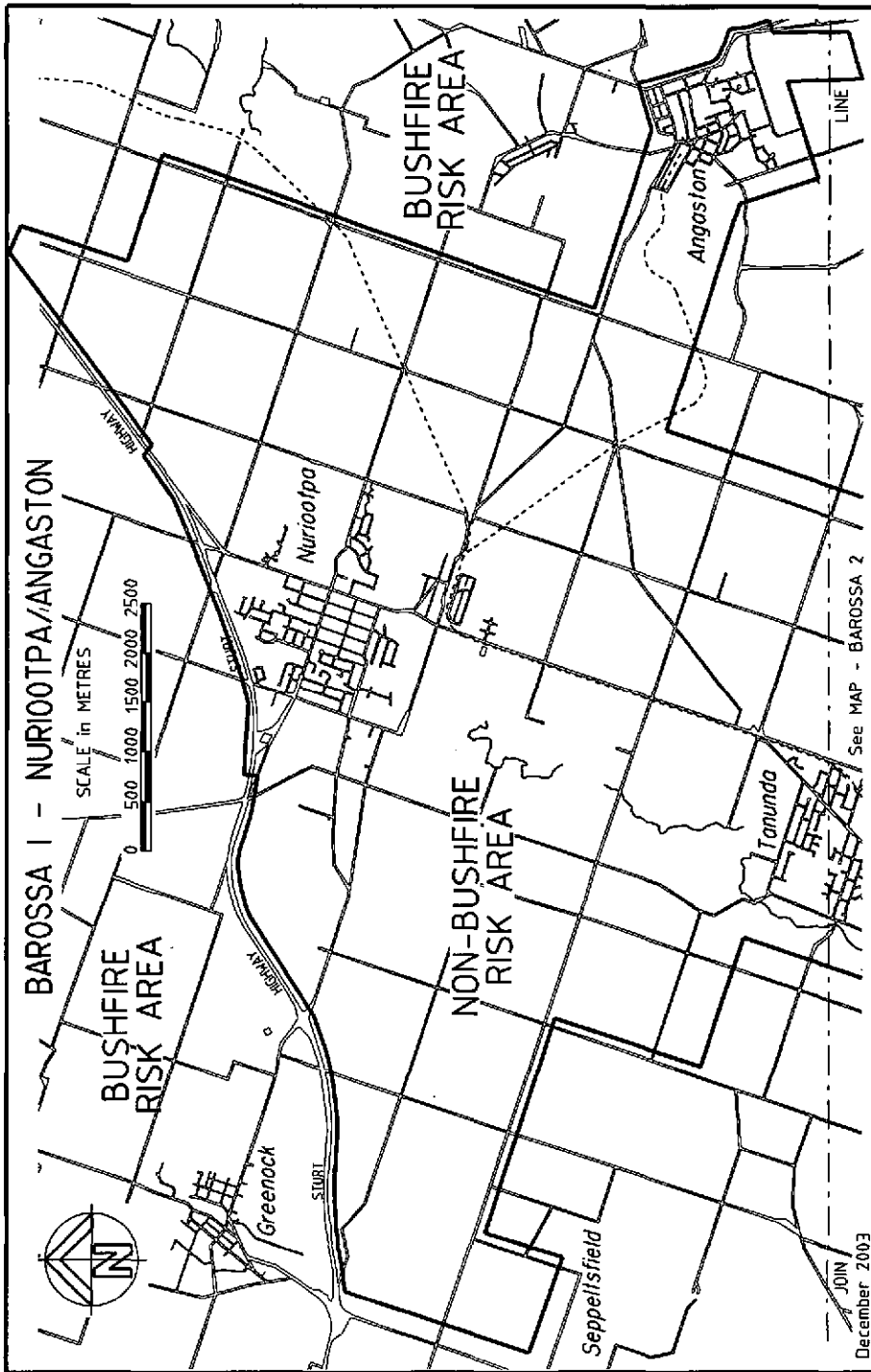

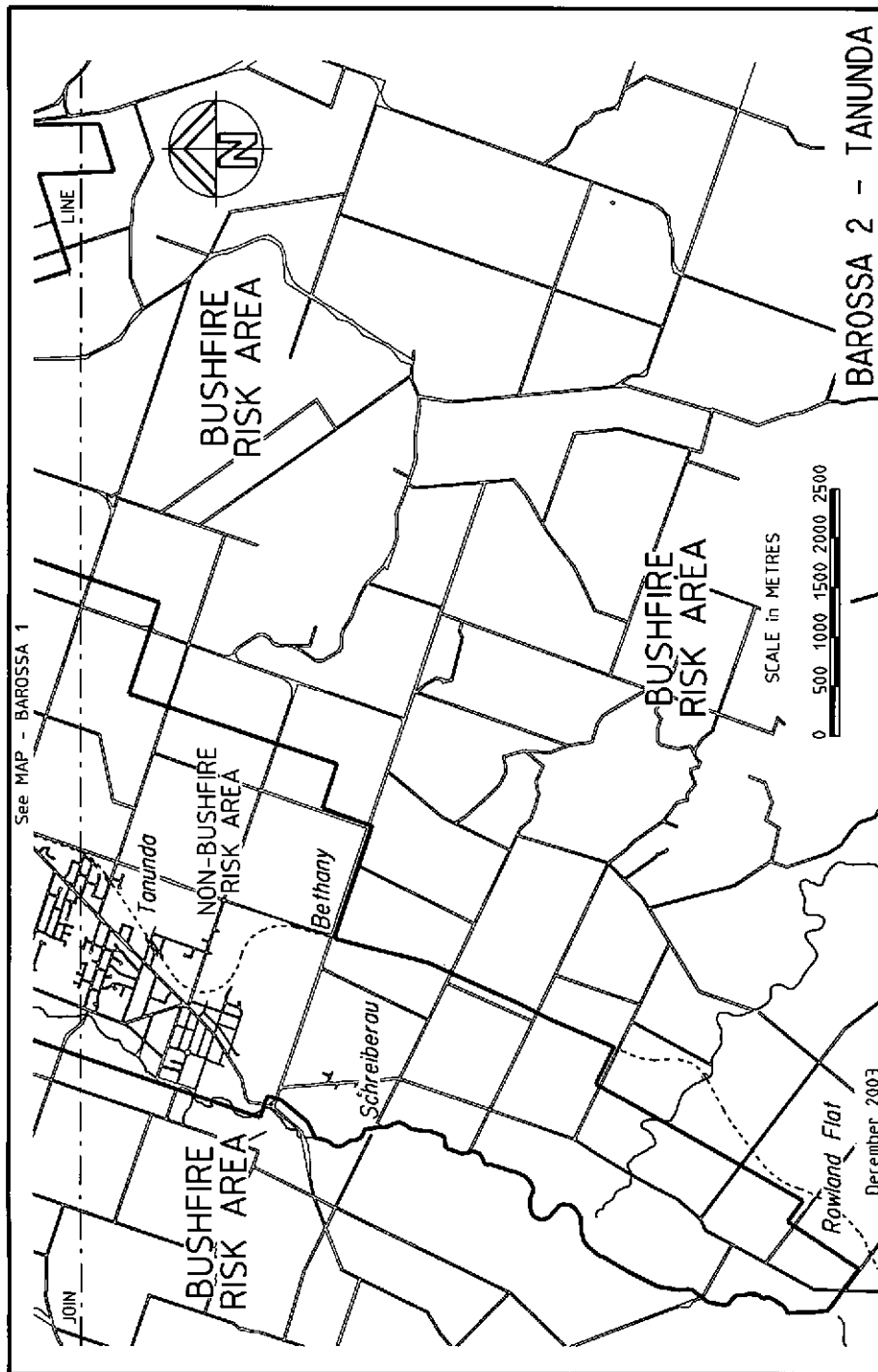

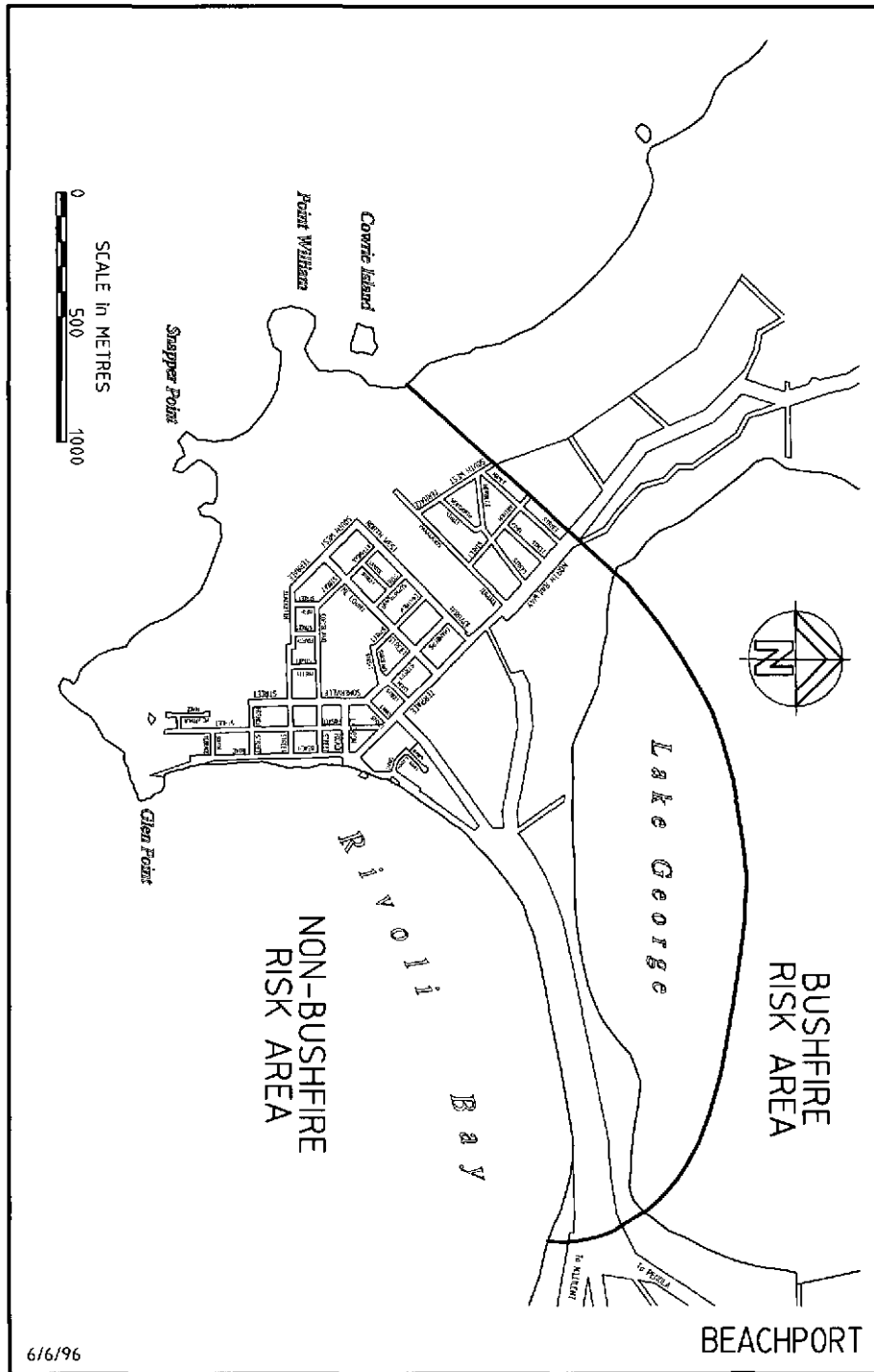

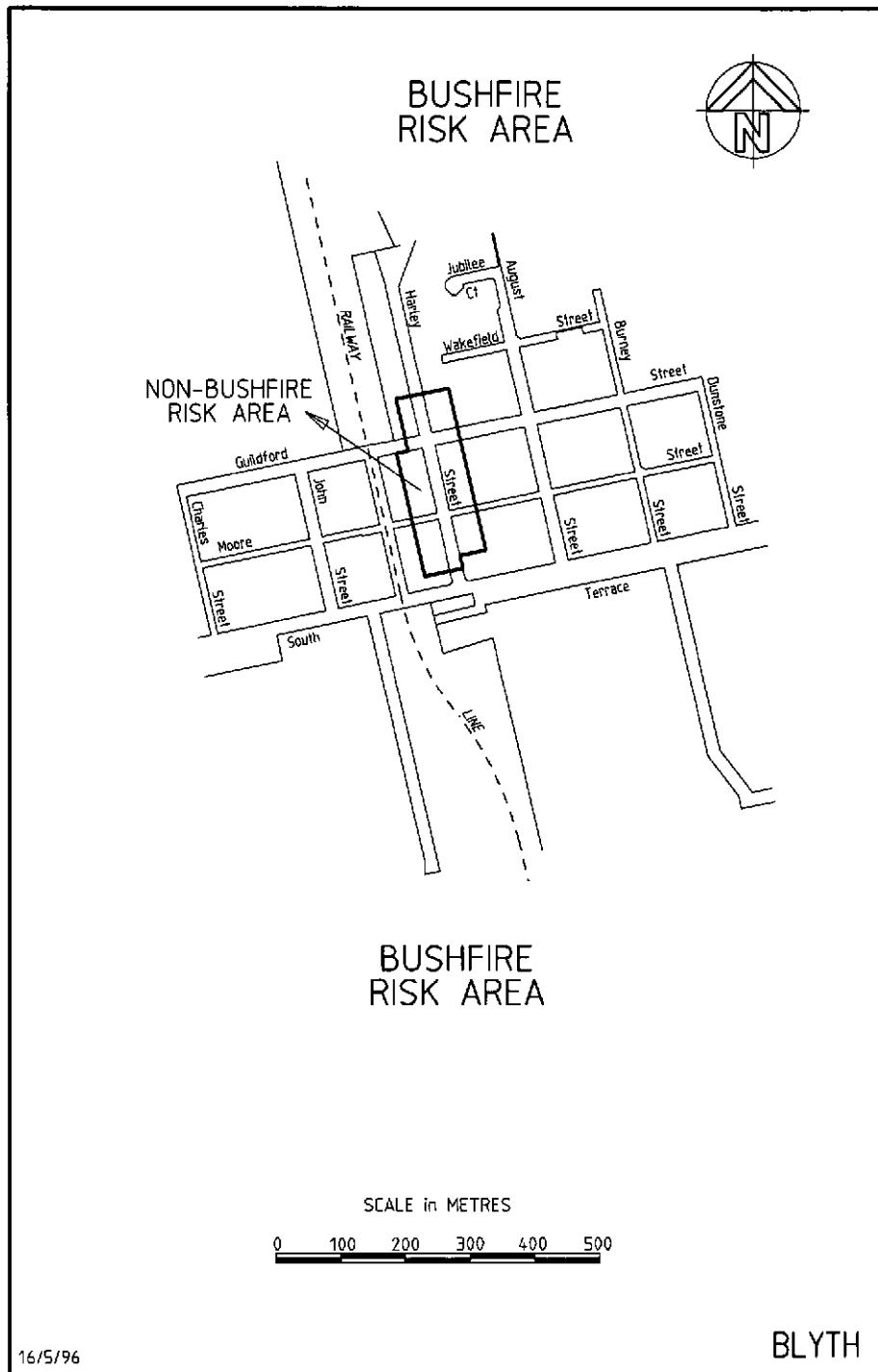

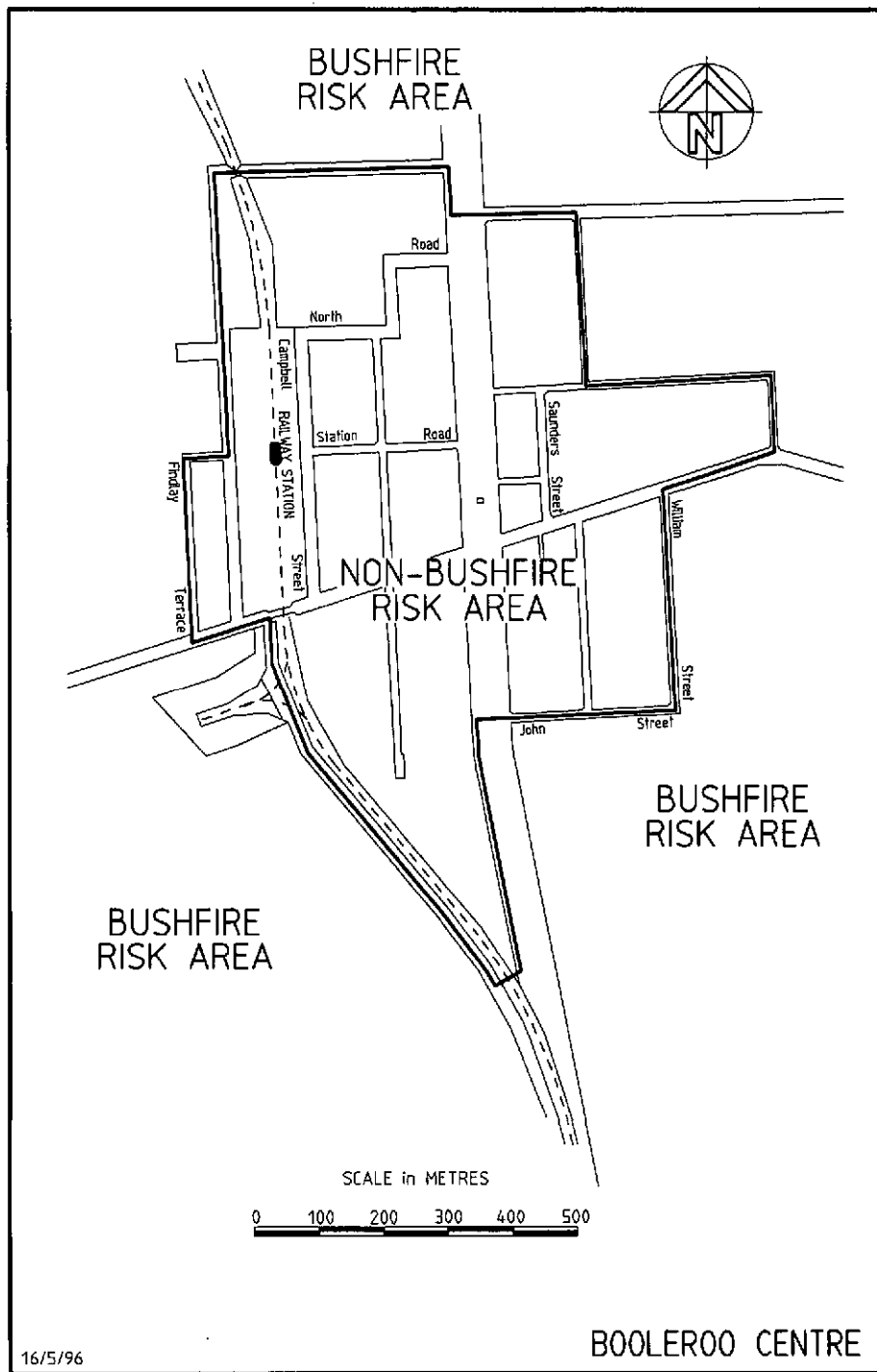

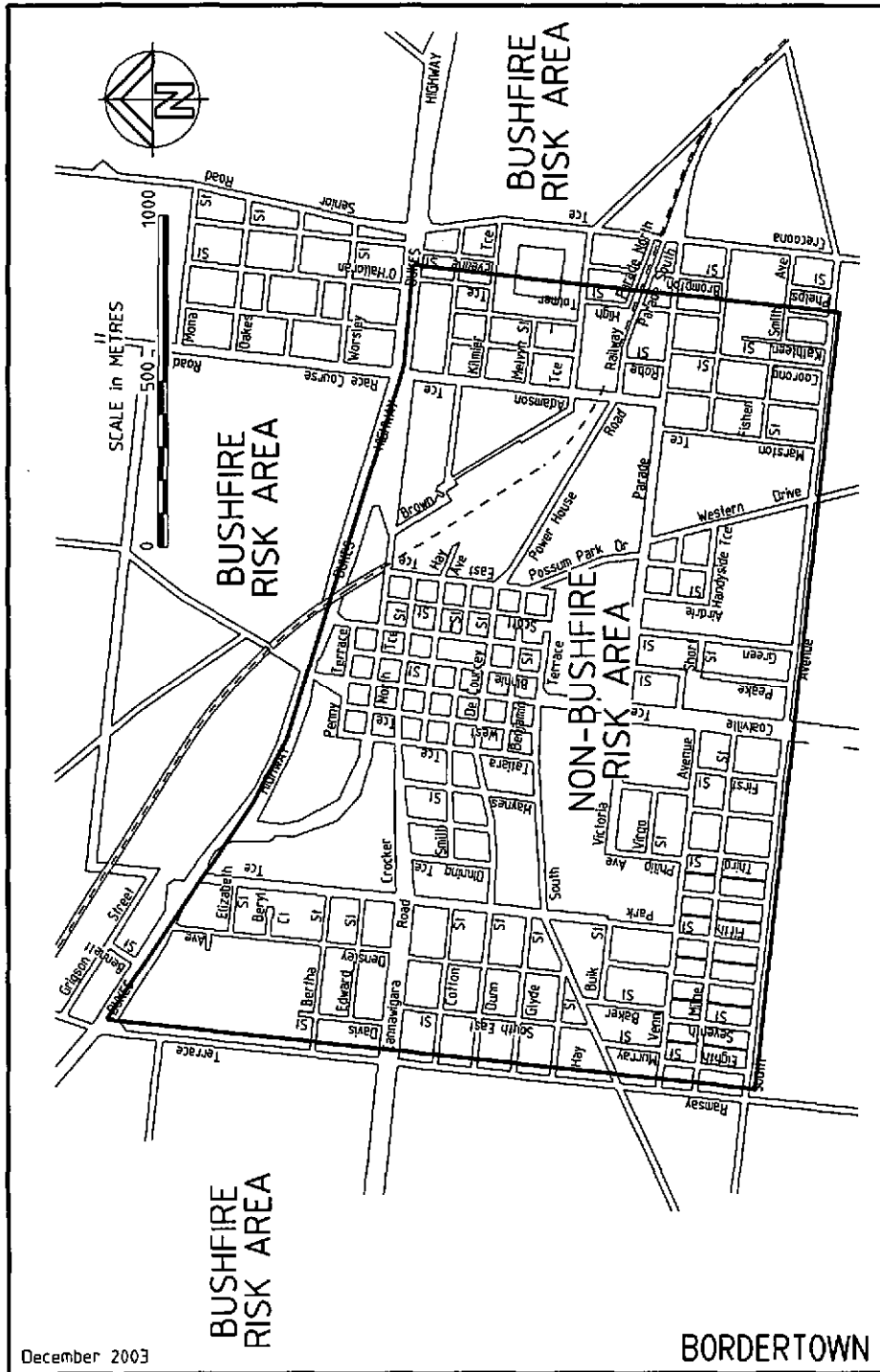

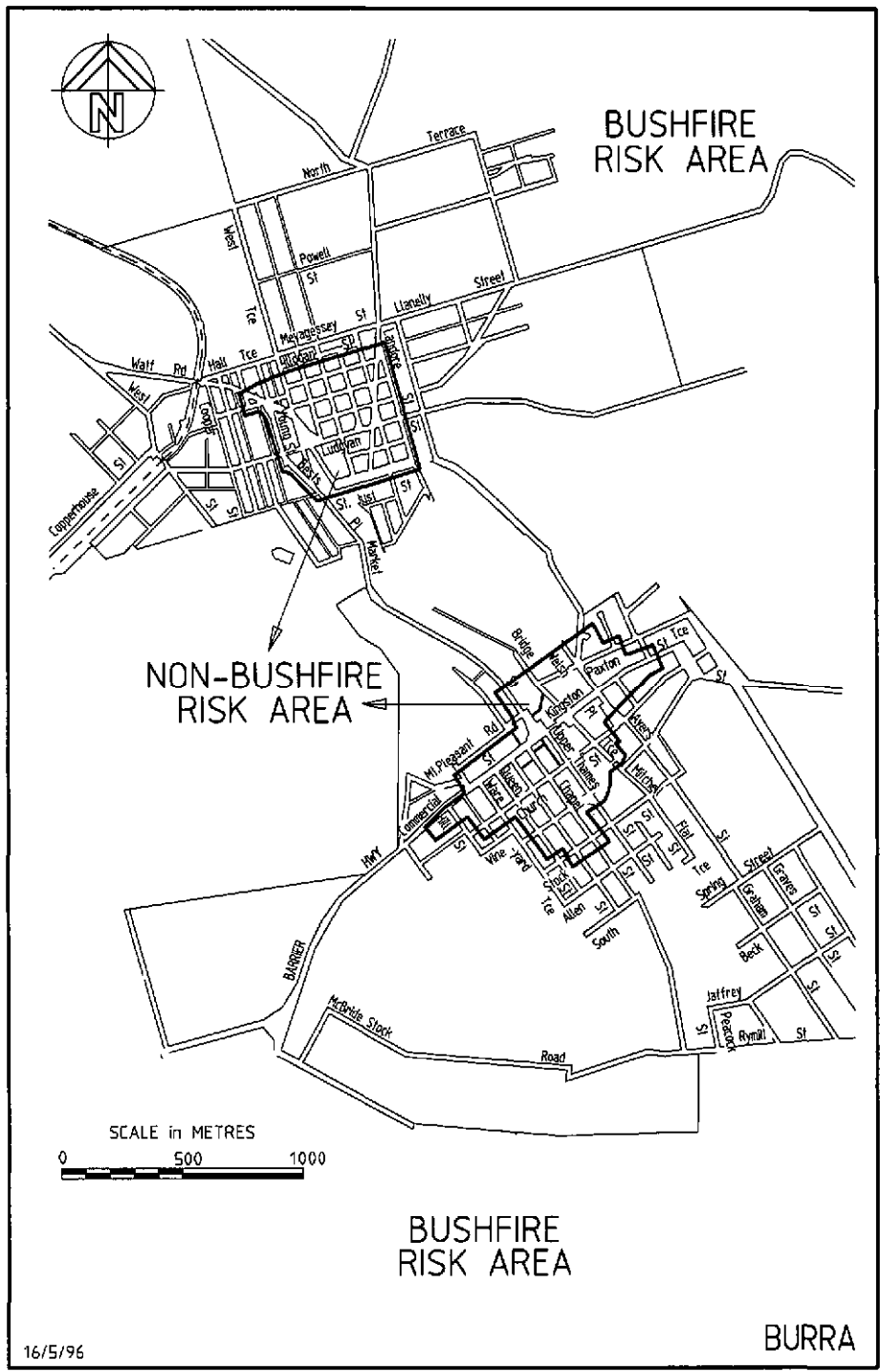

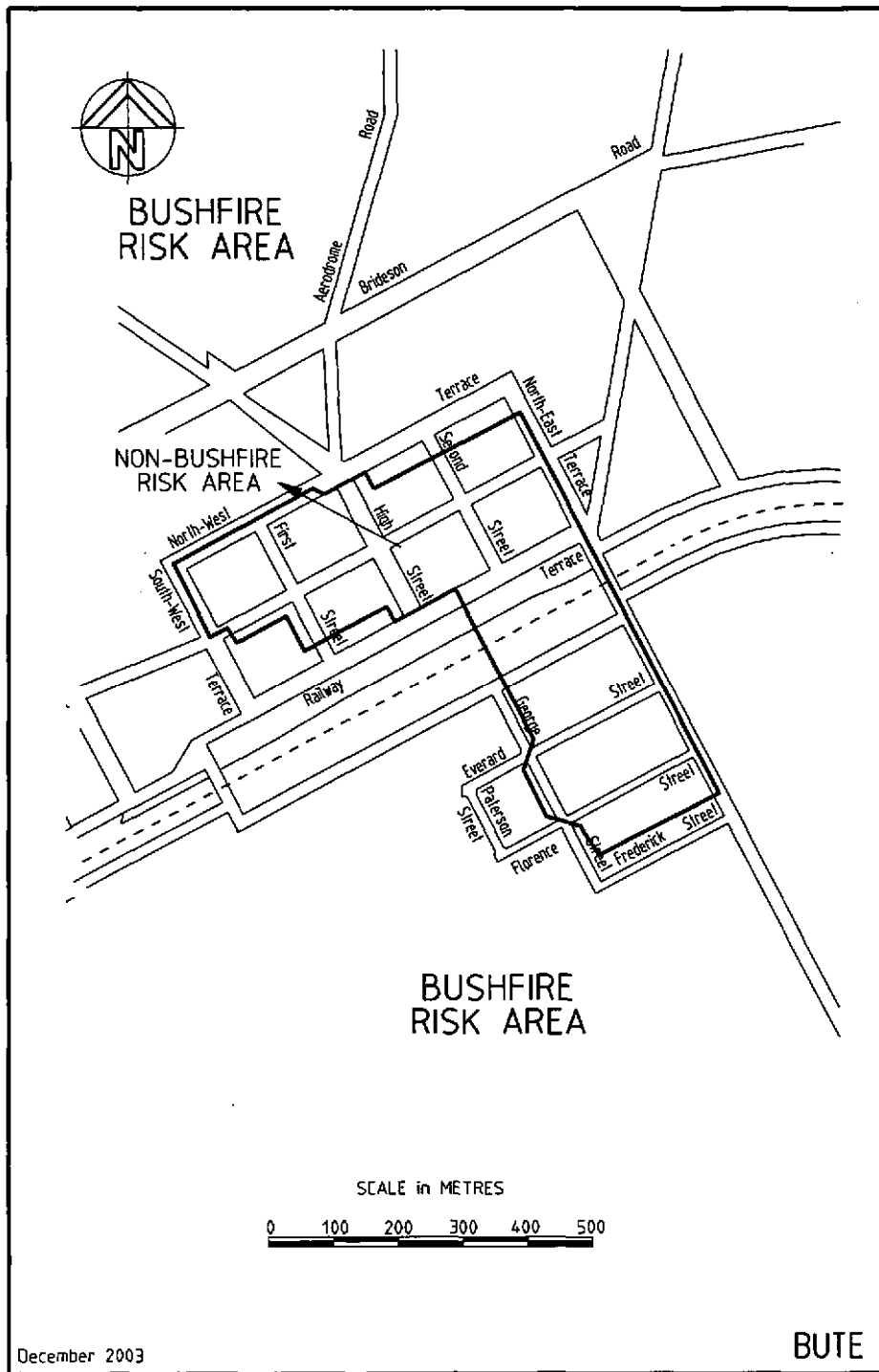

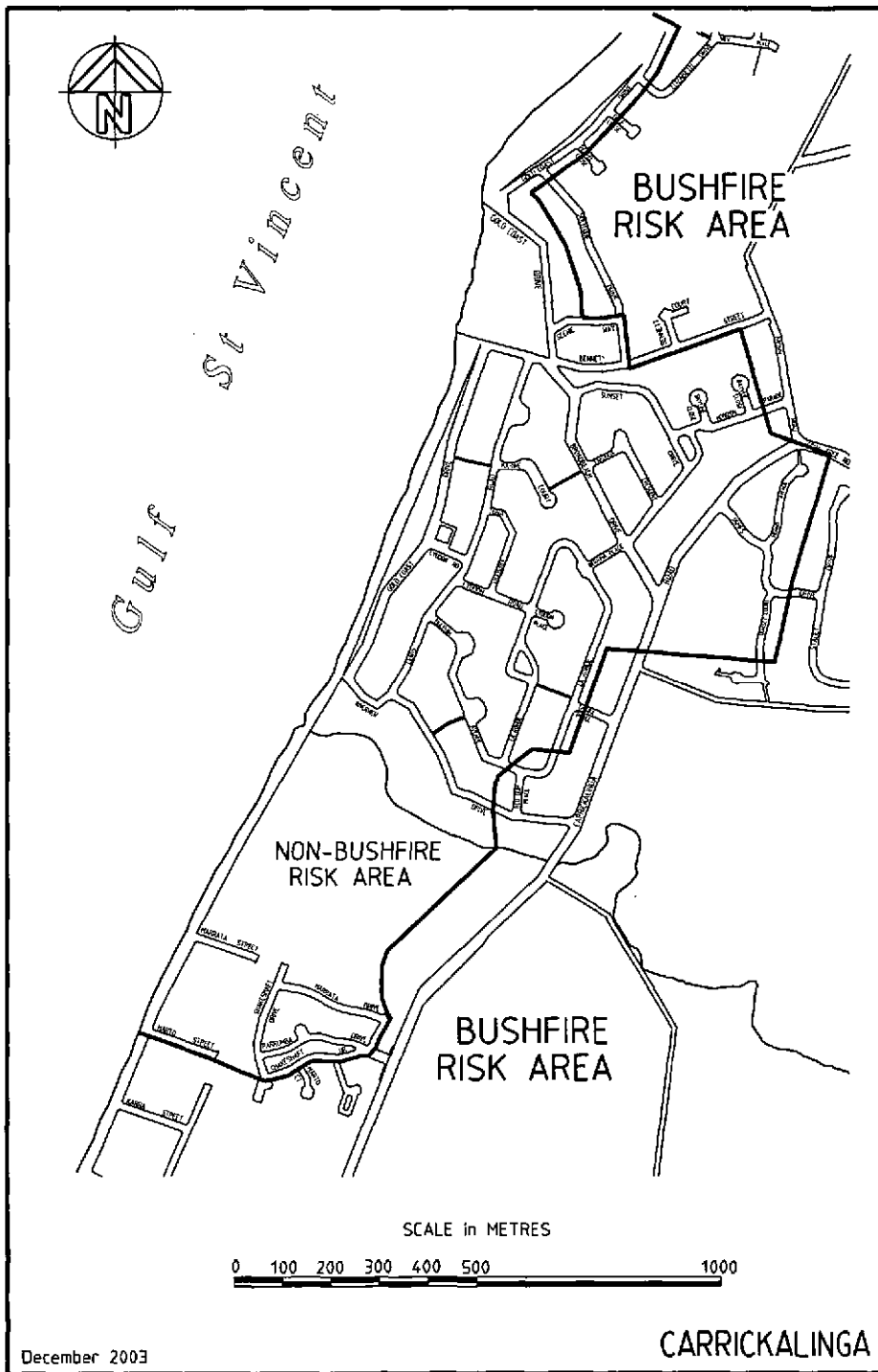

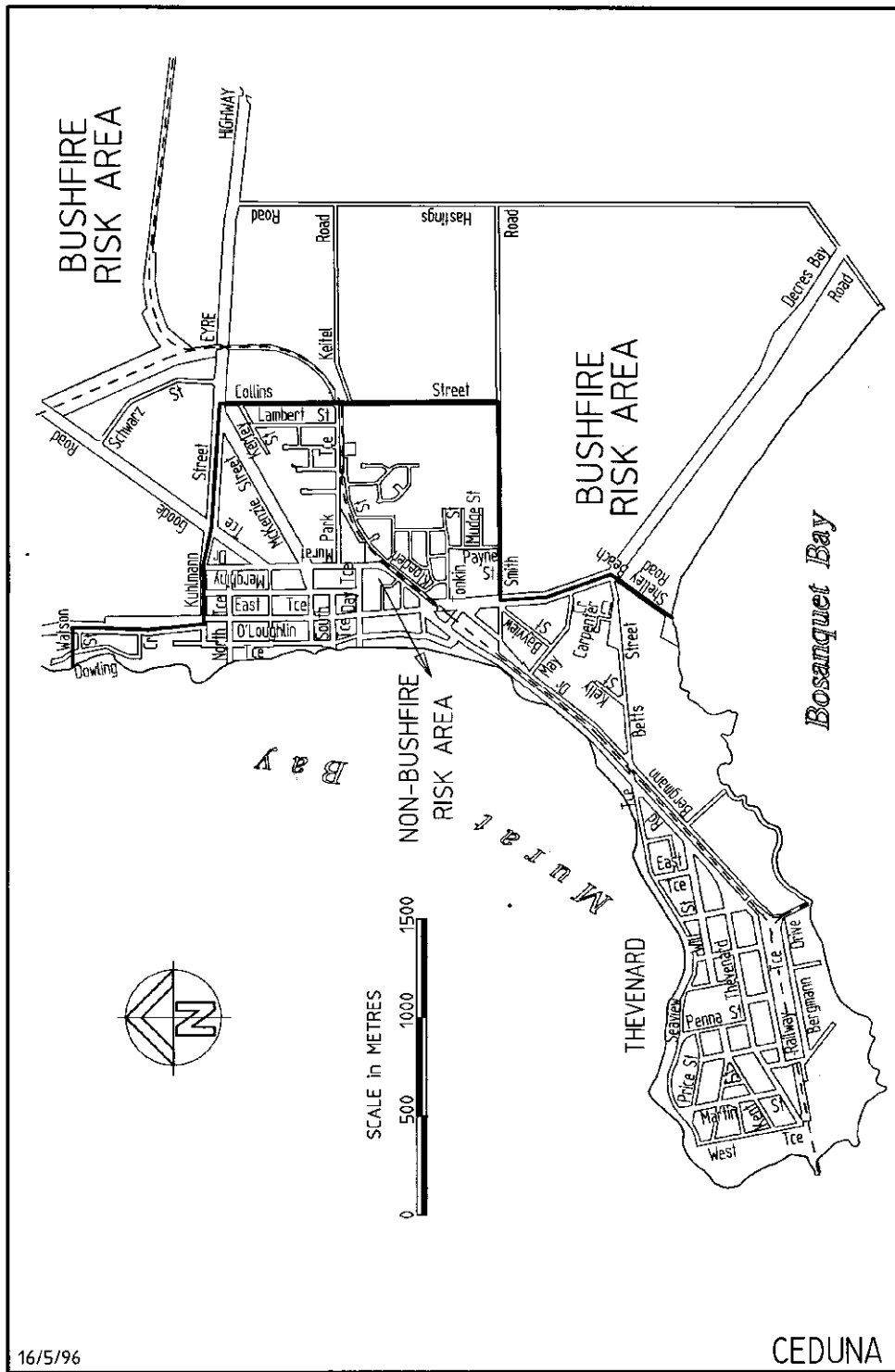

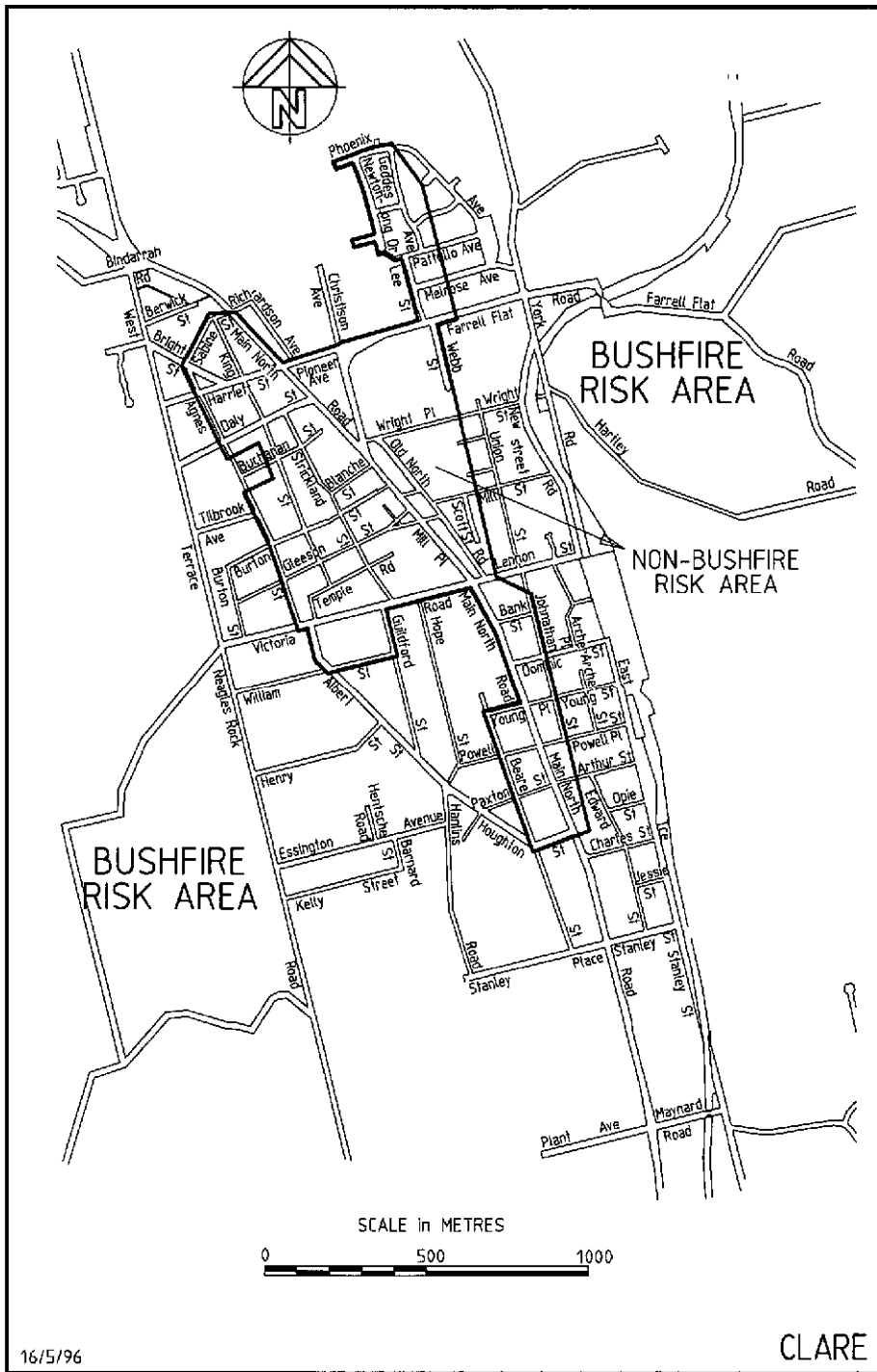

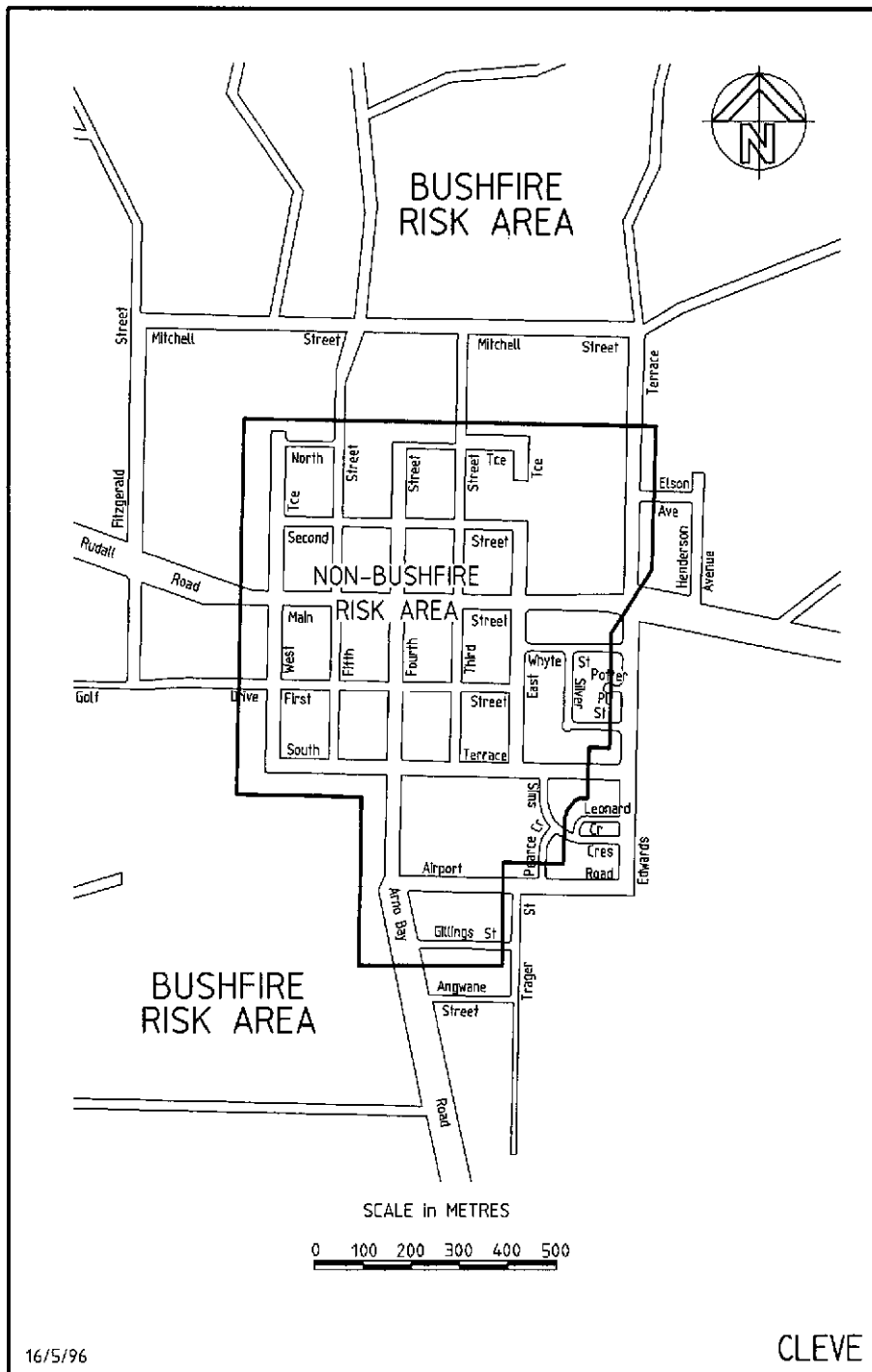

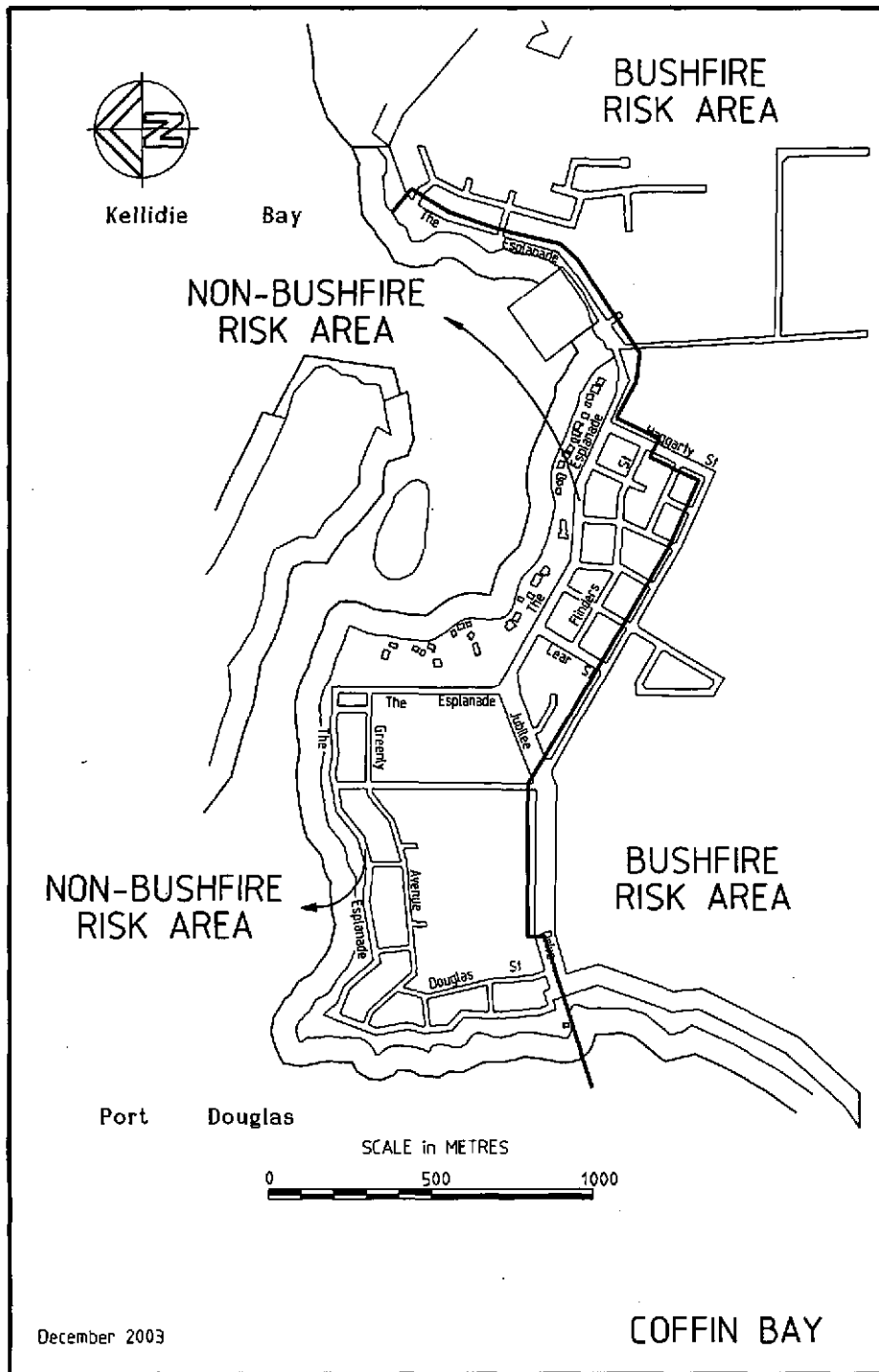

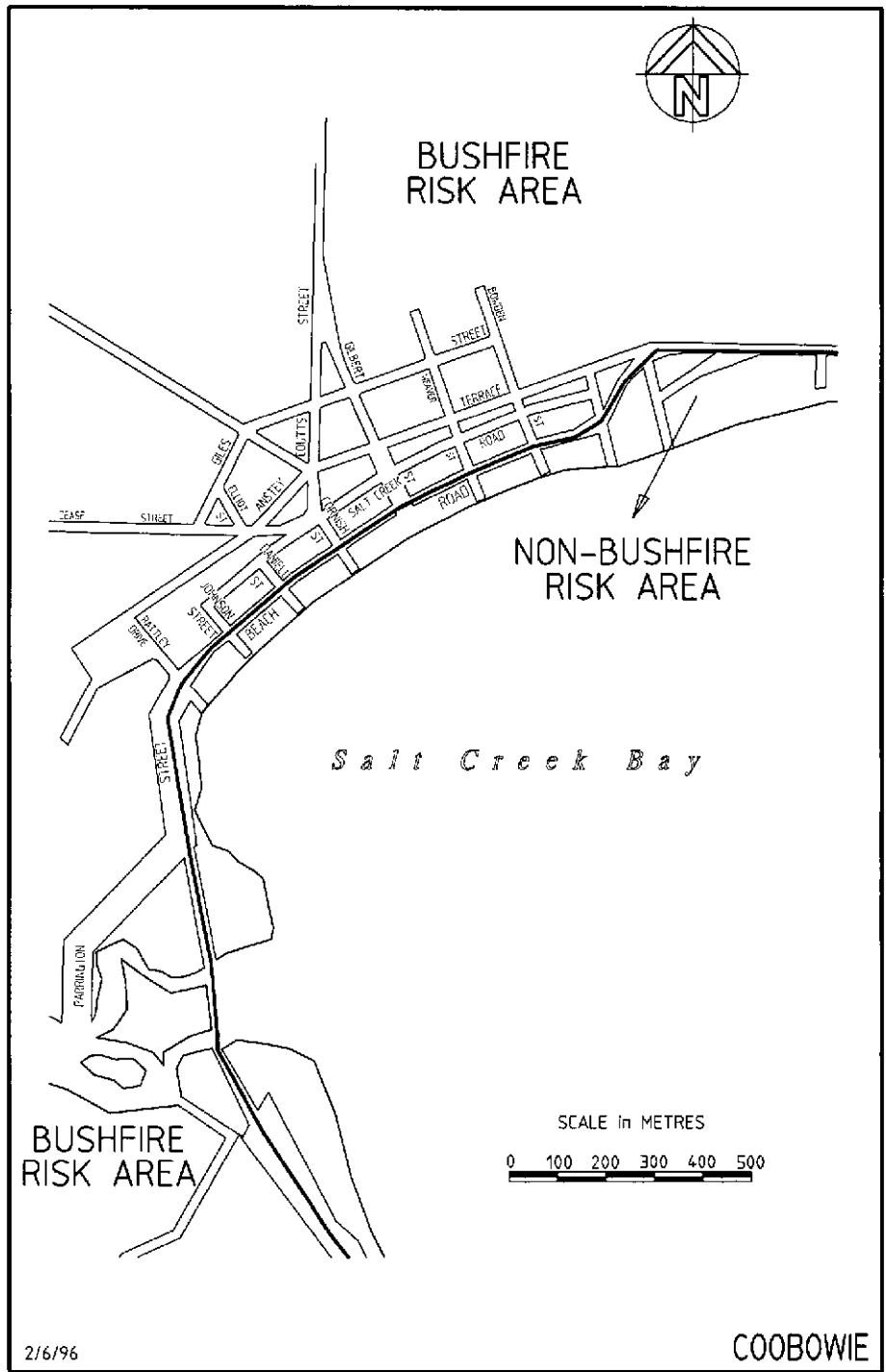

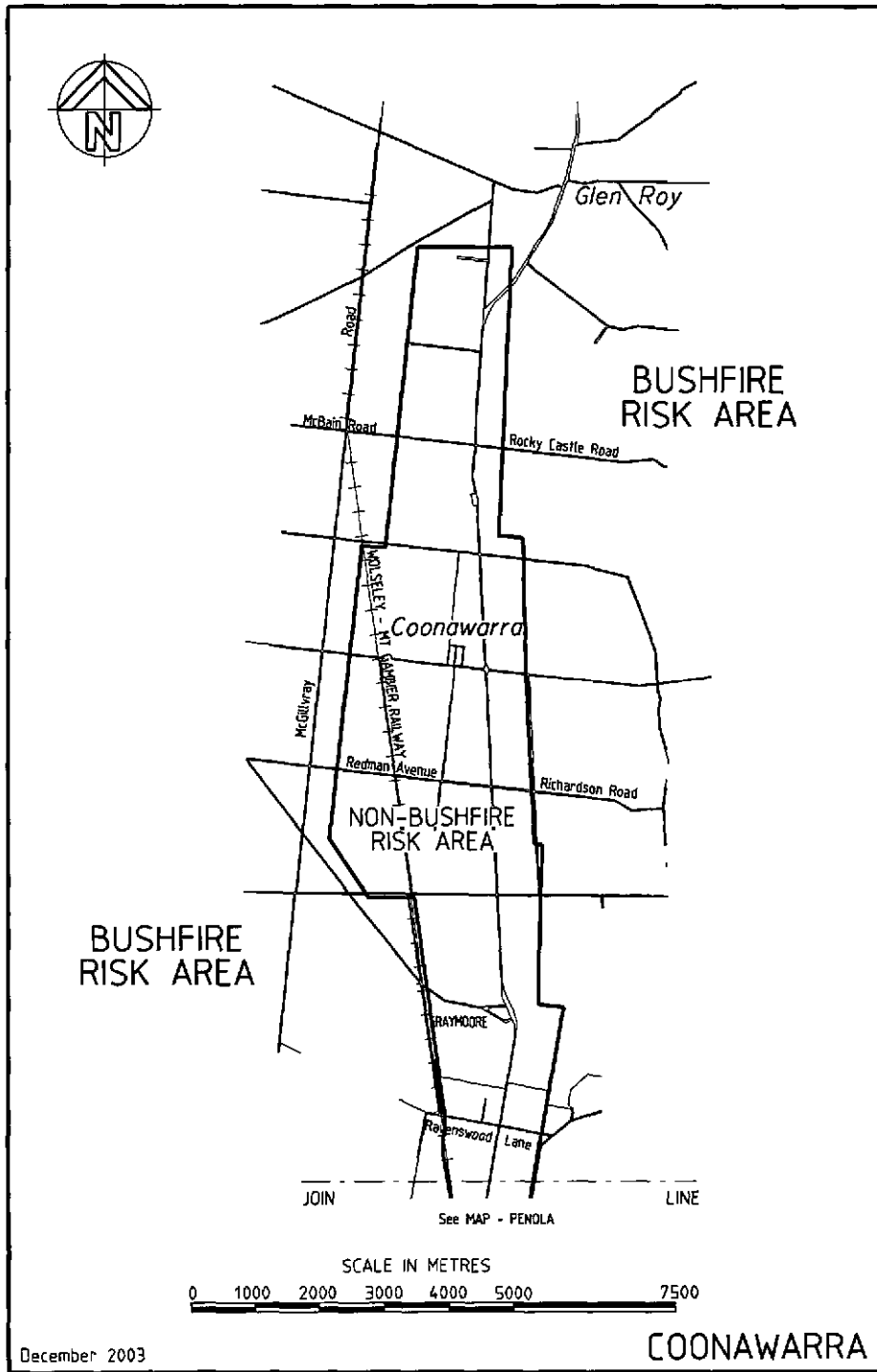

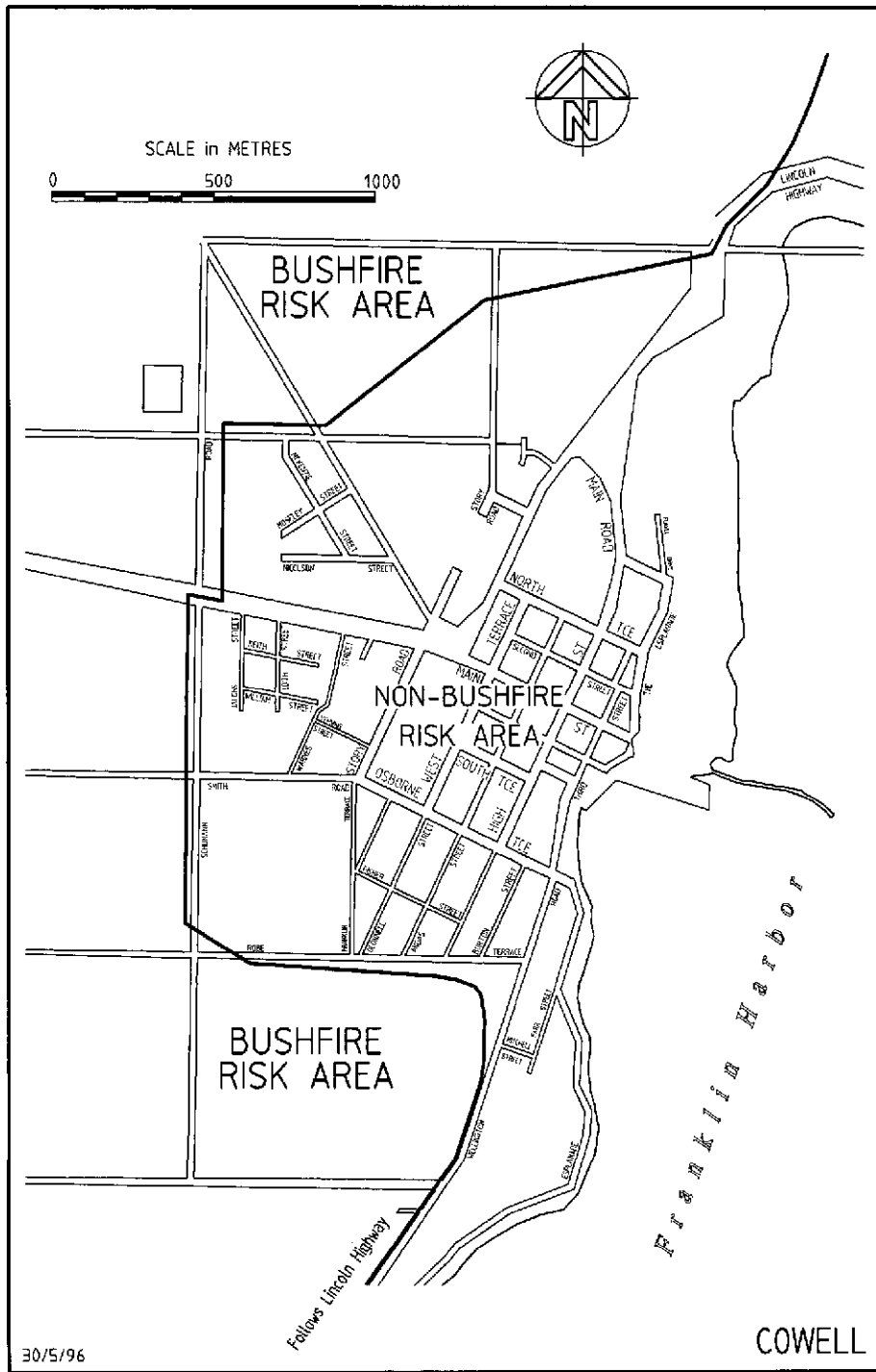

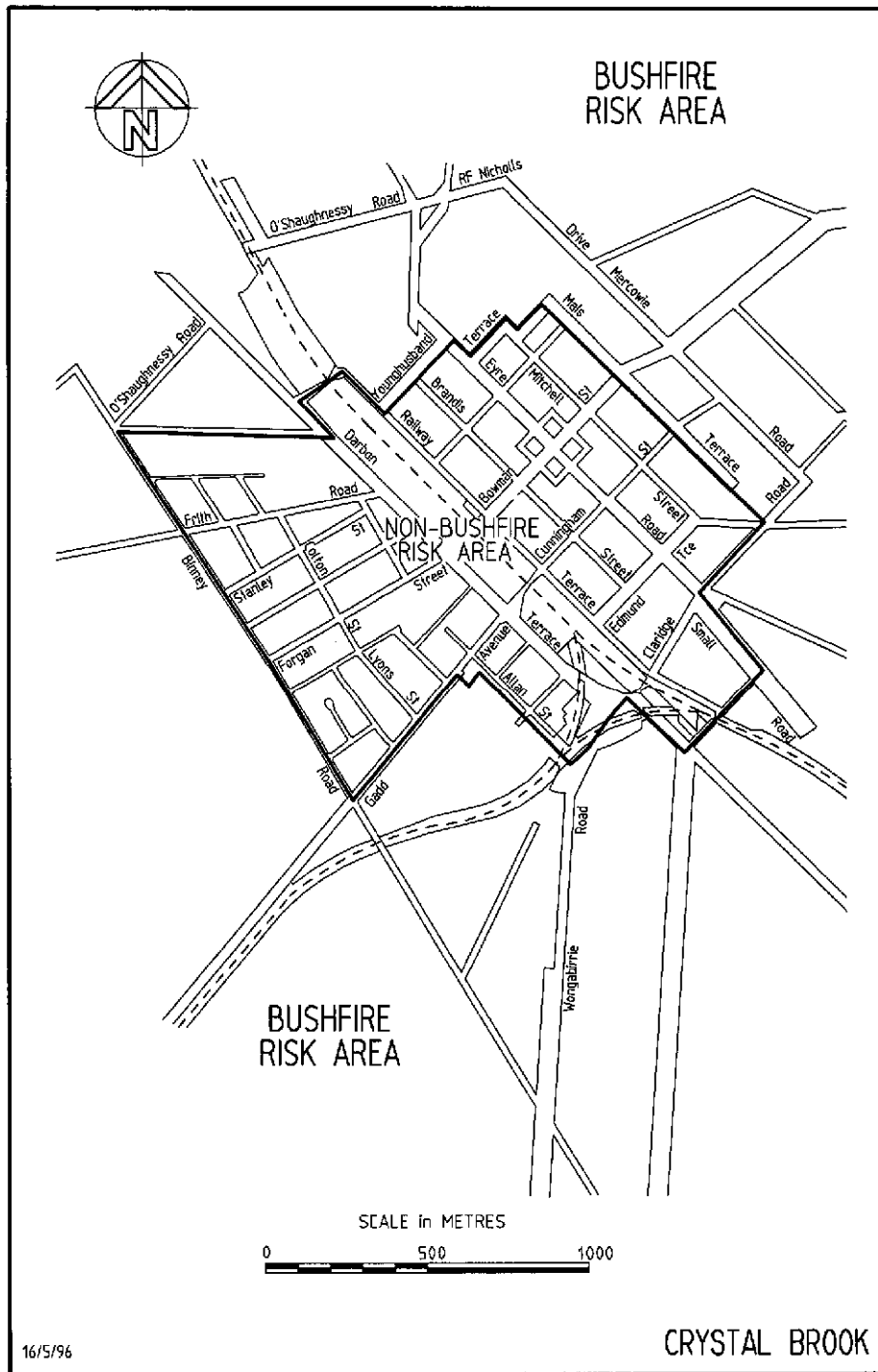

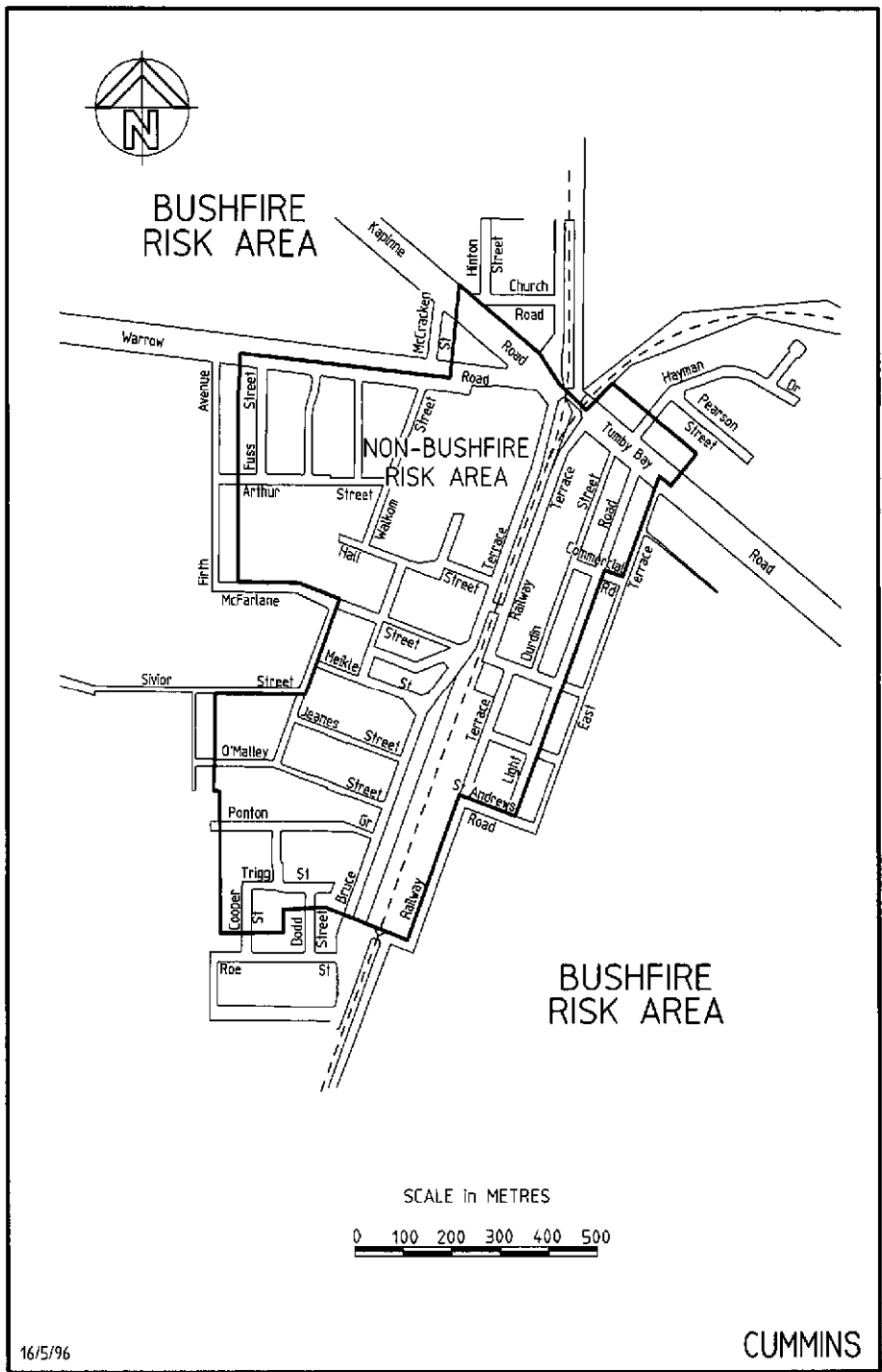

16/5/96

CUMMINS

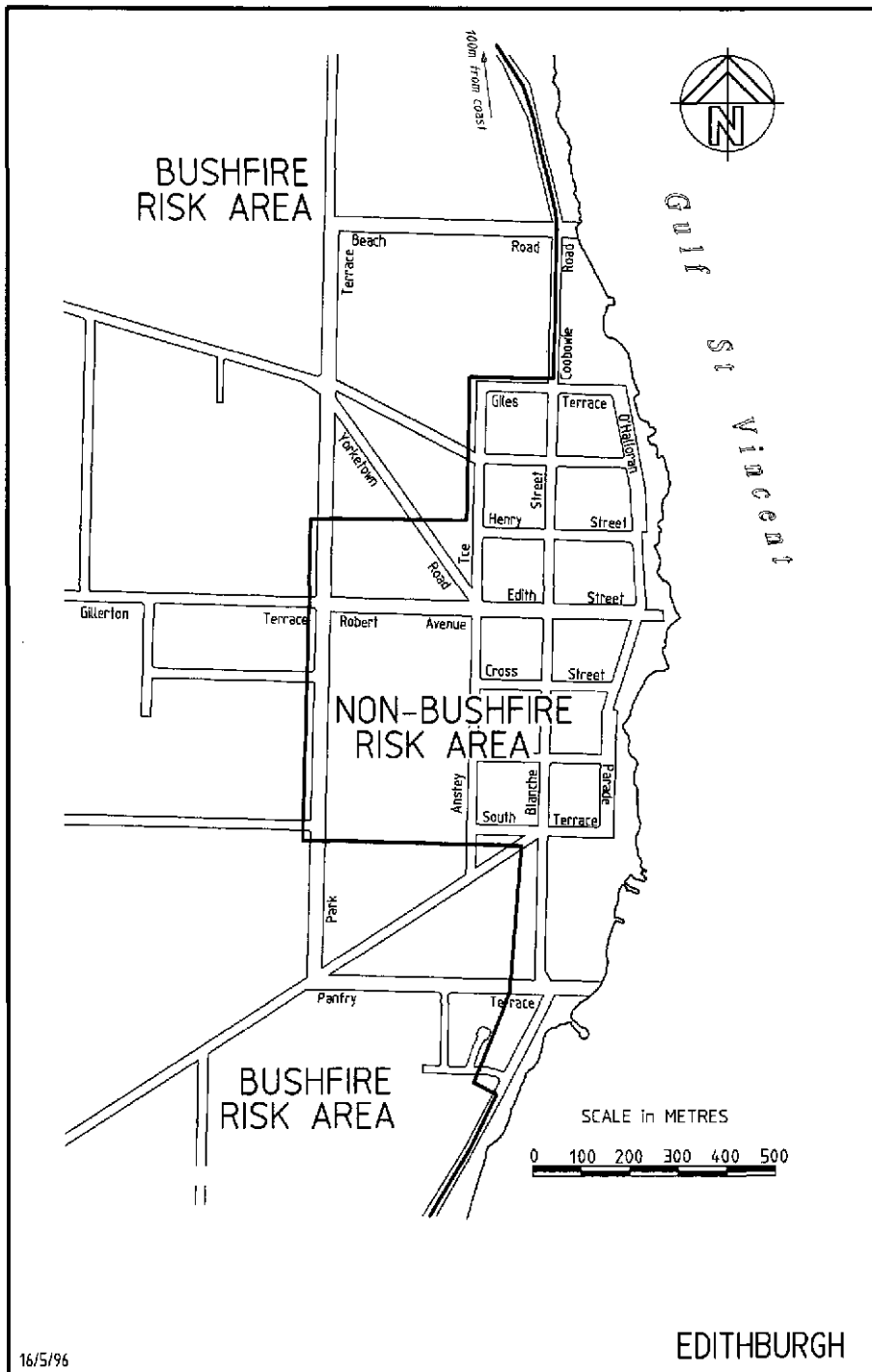

16/5/96

EDITHBURGH

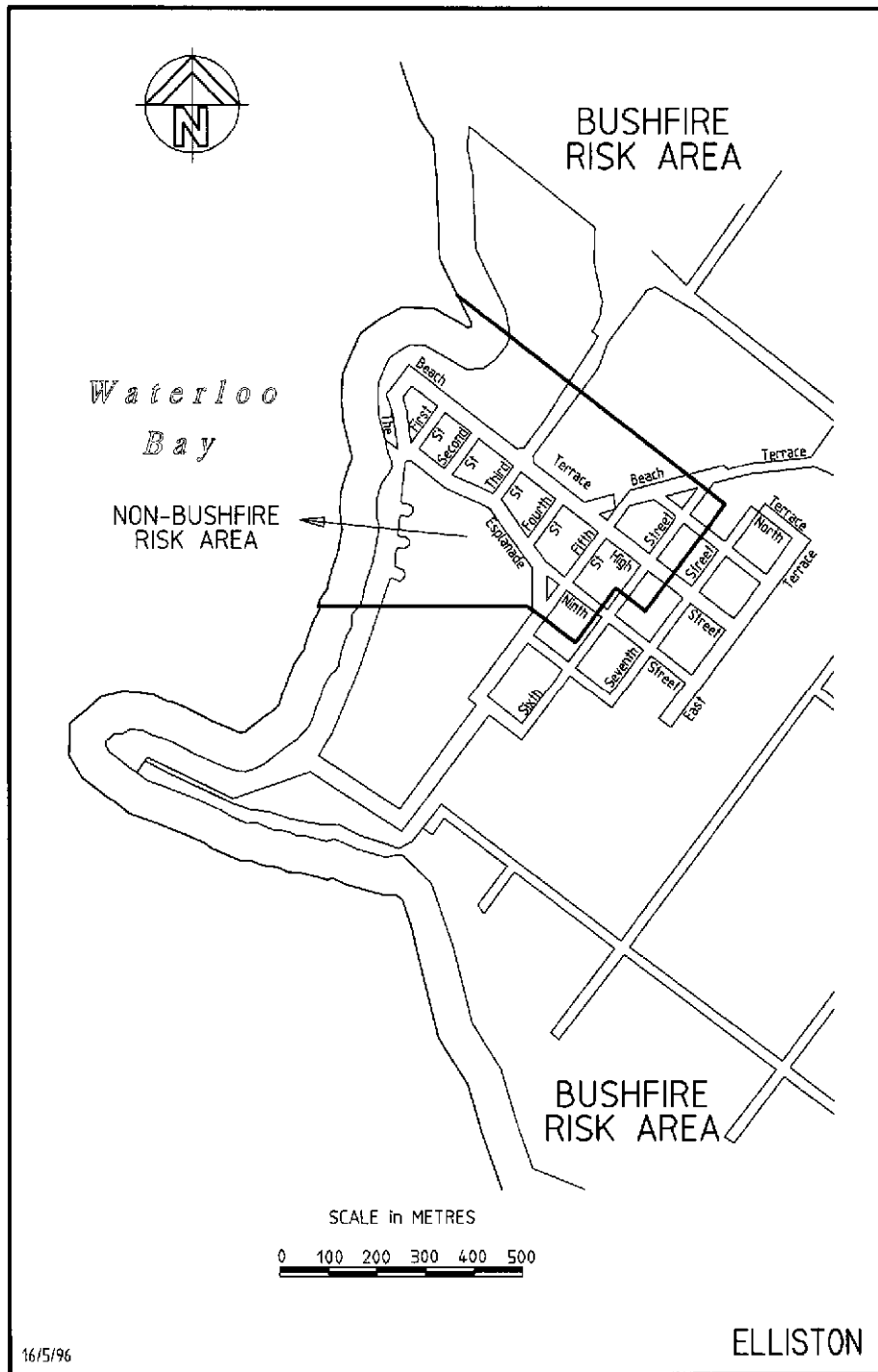

16/5/96

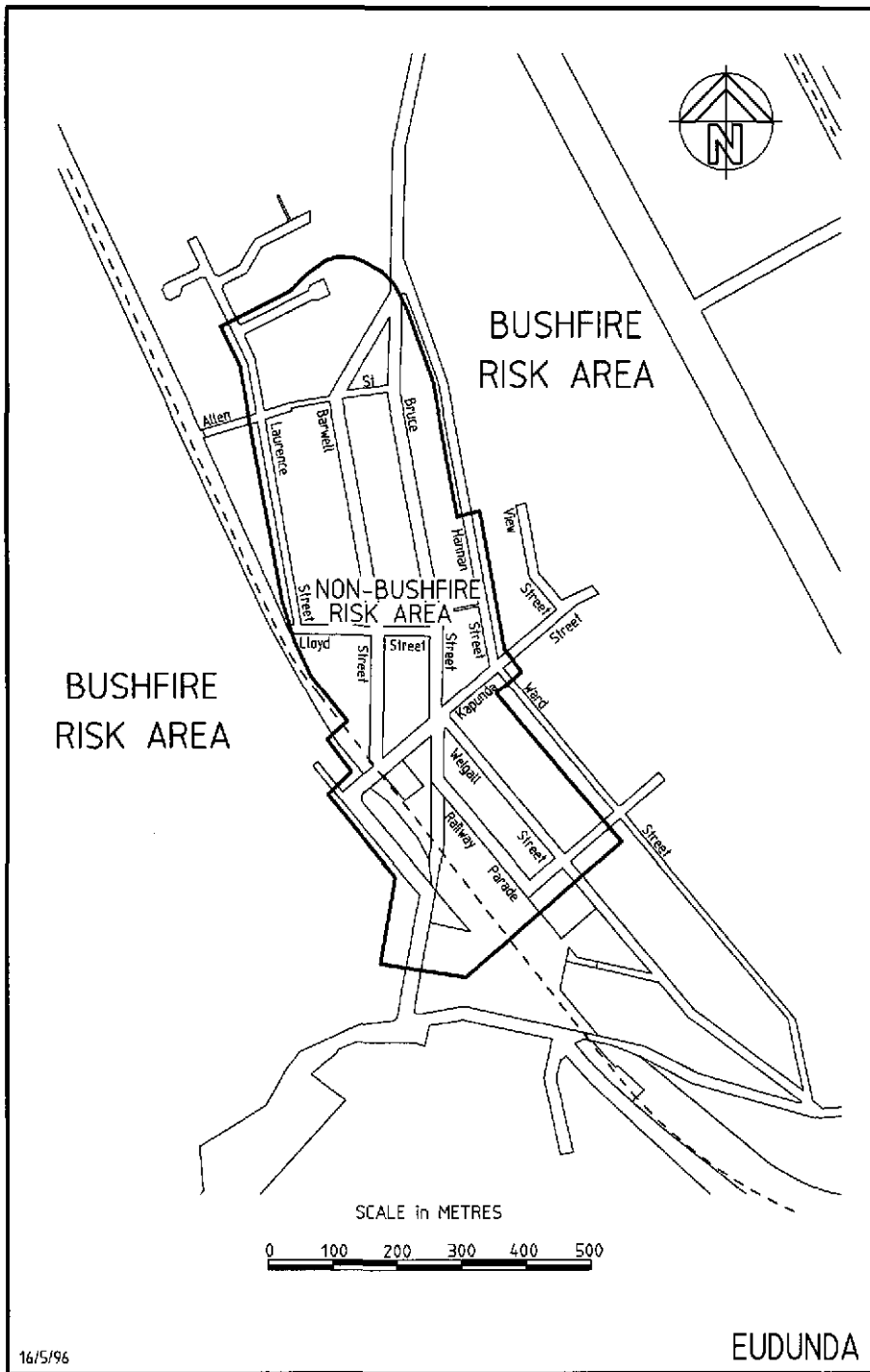

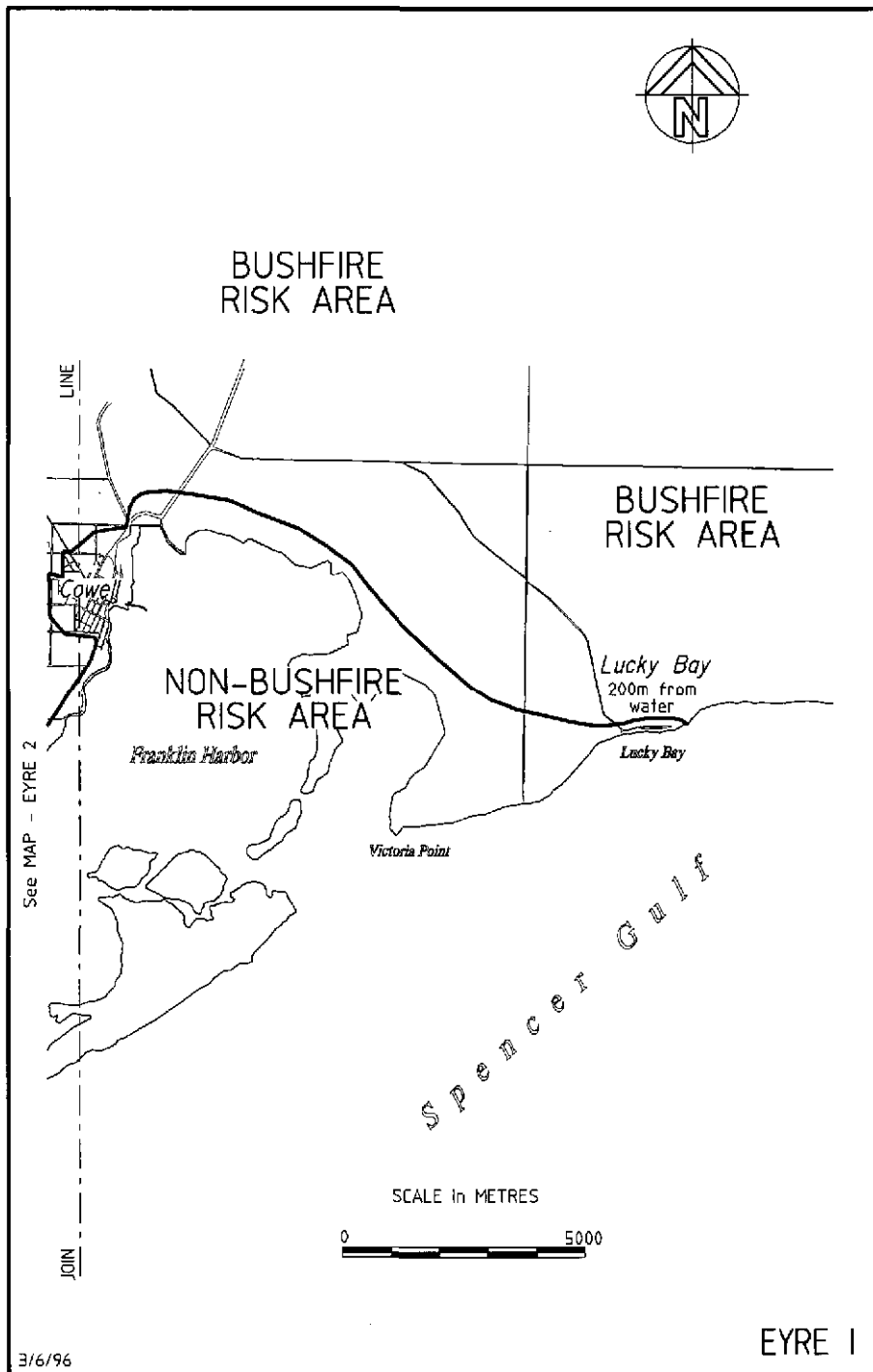

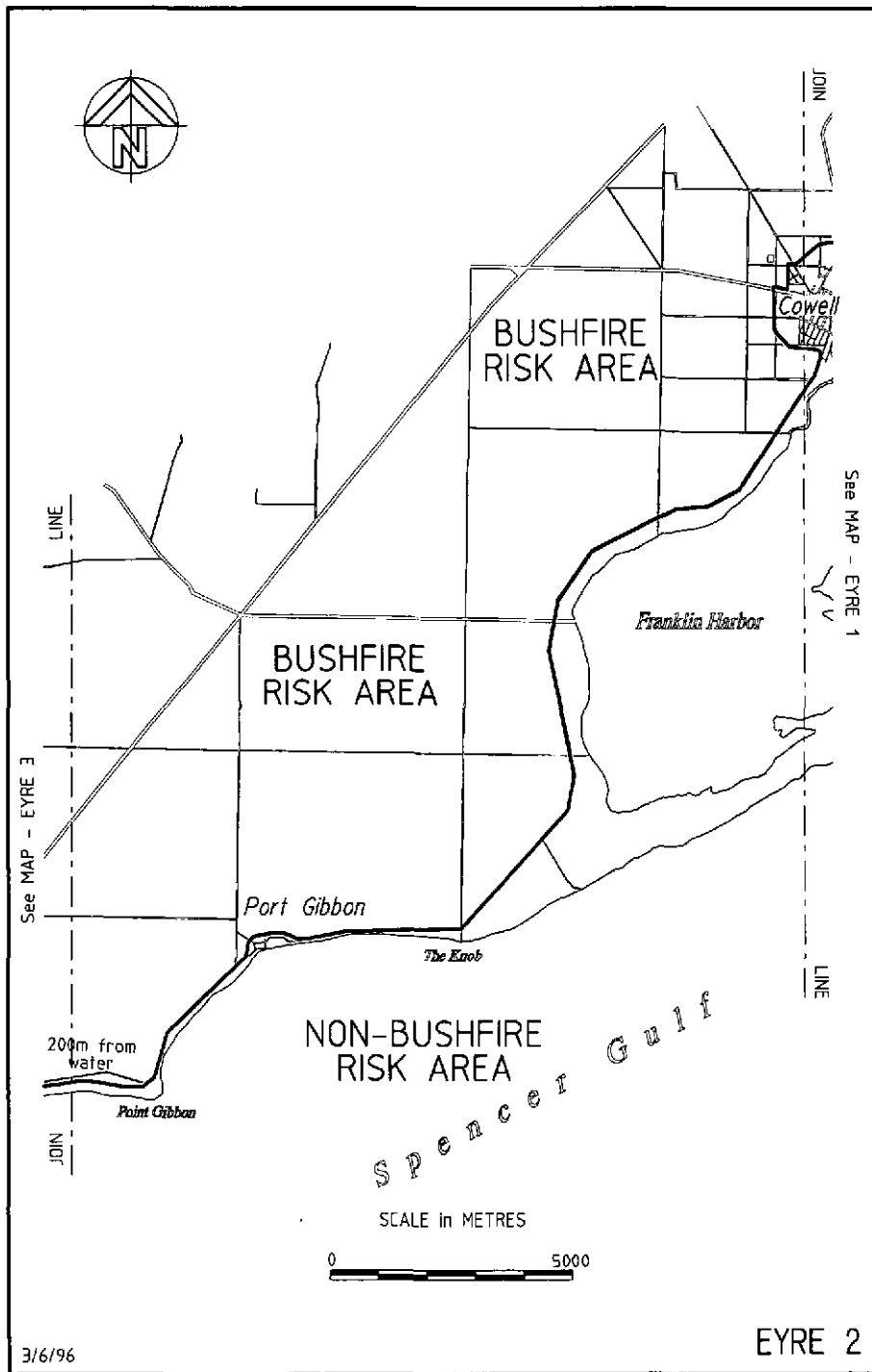

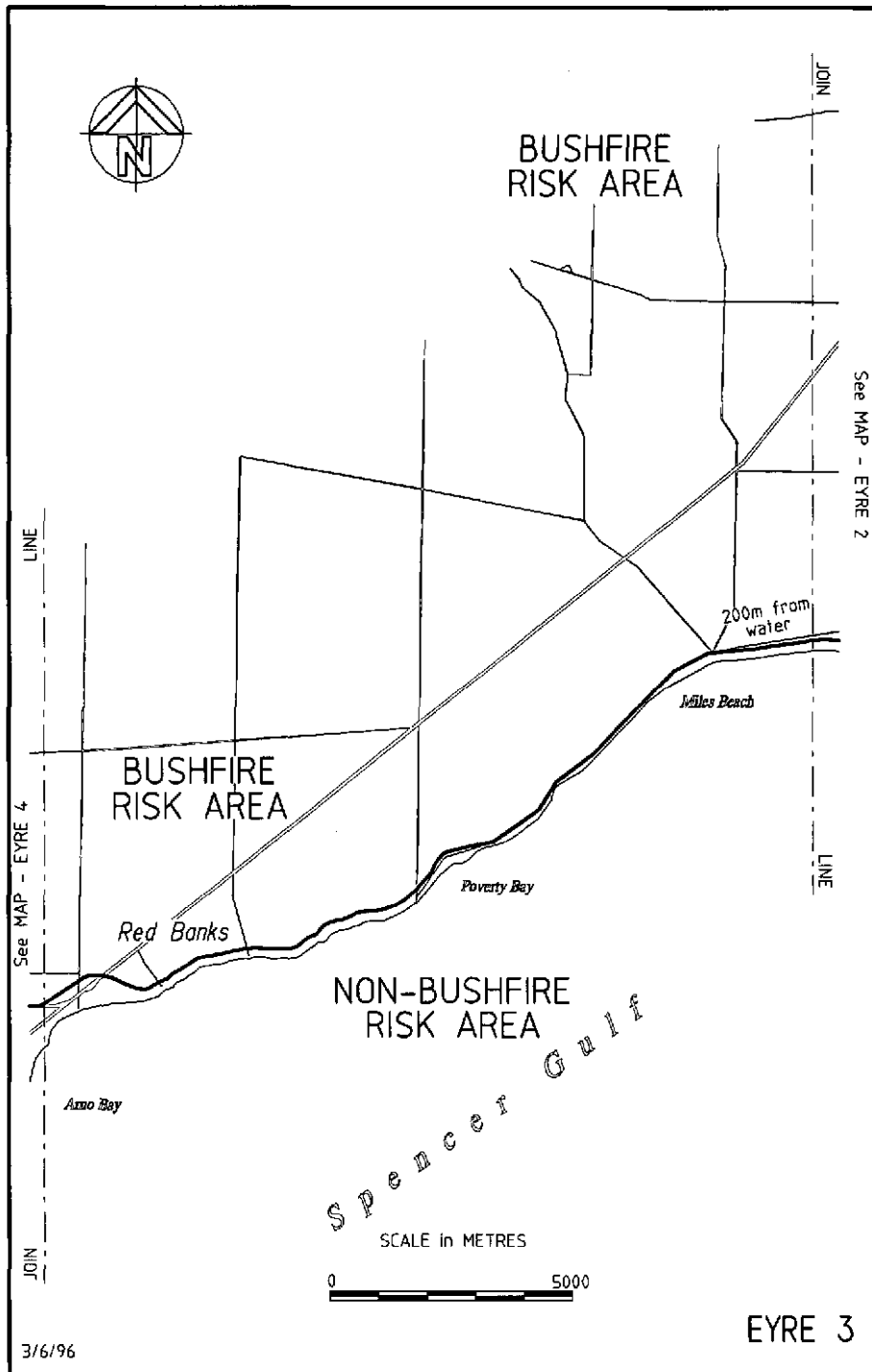

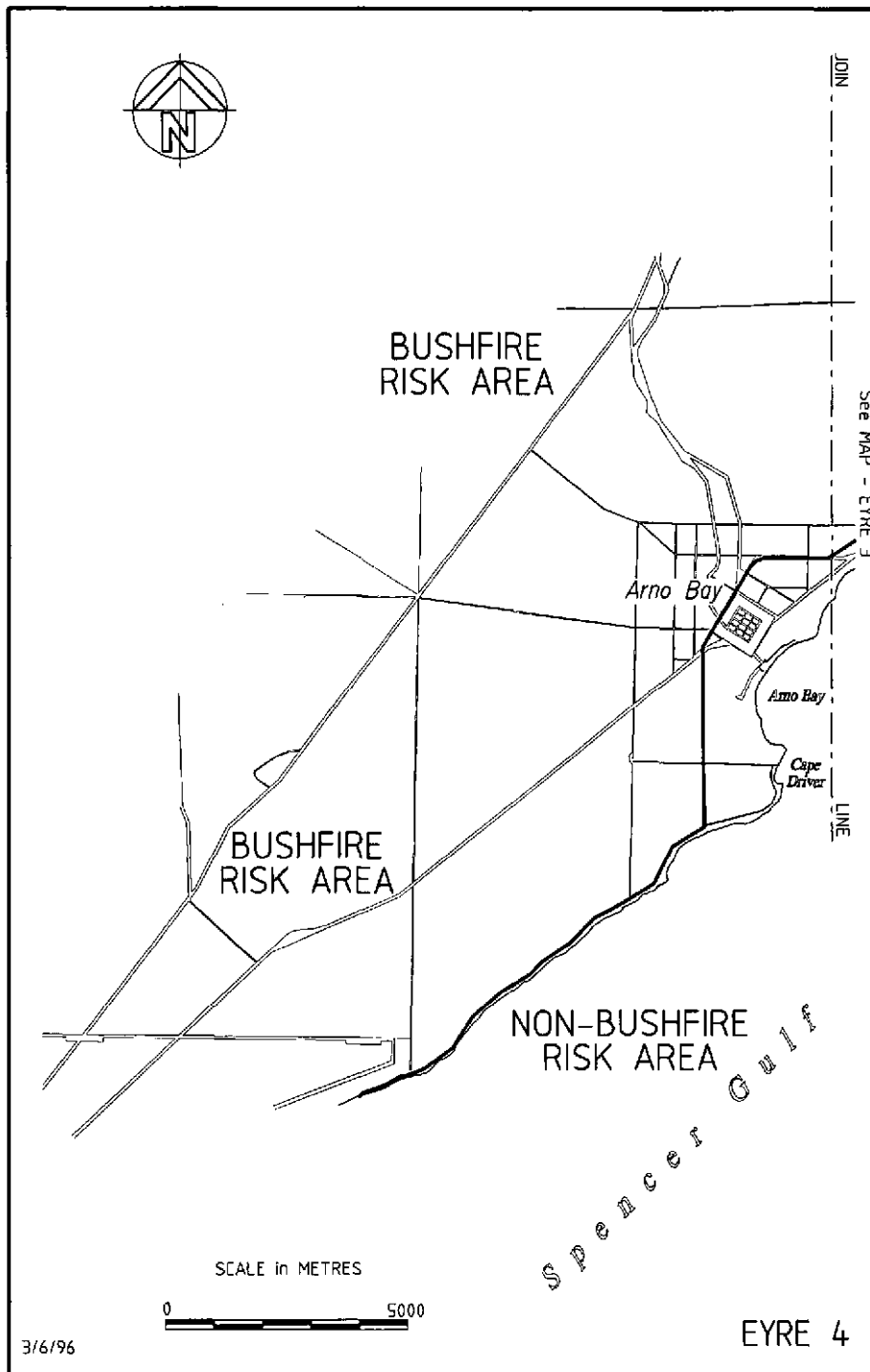

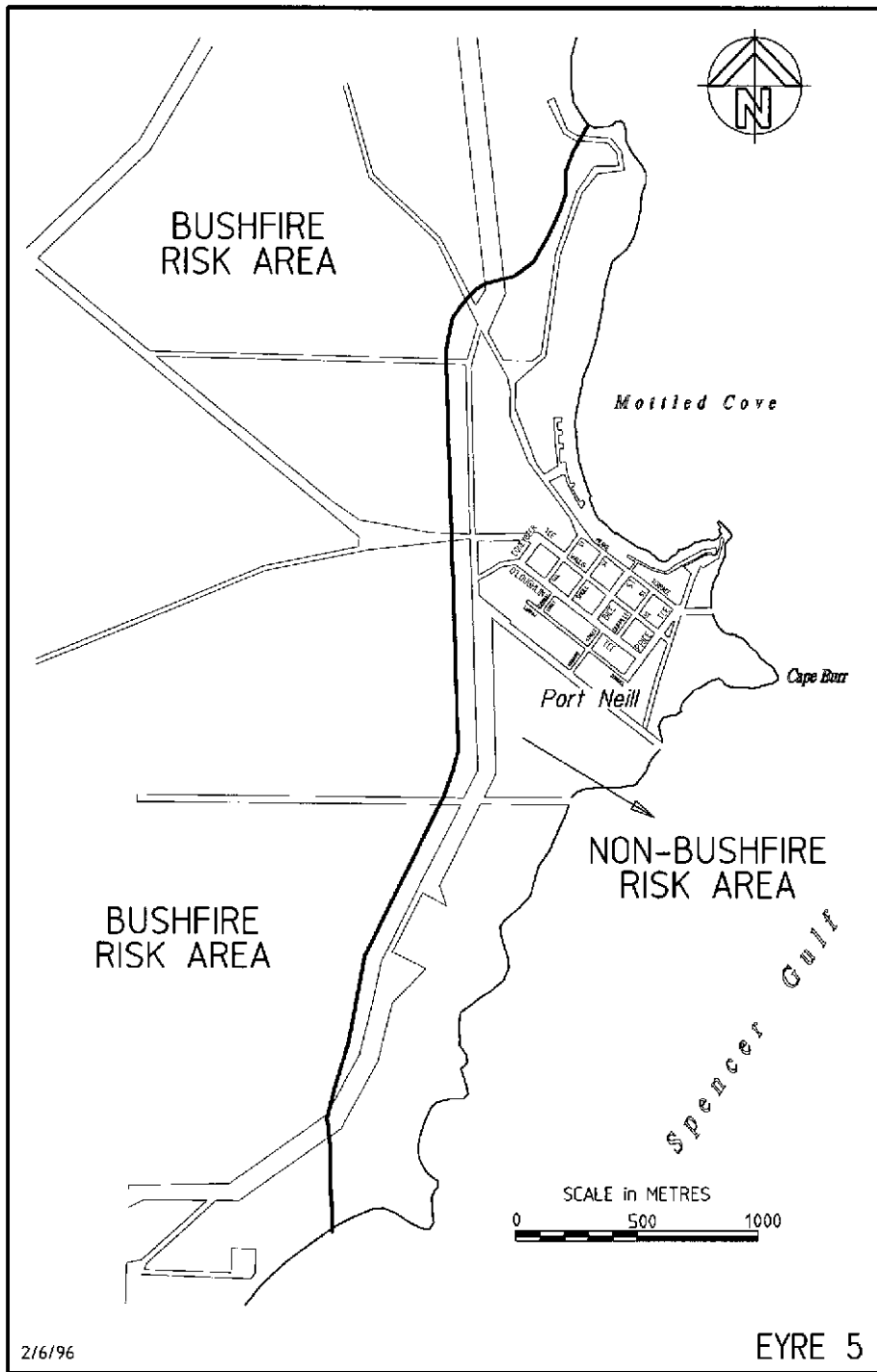

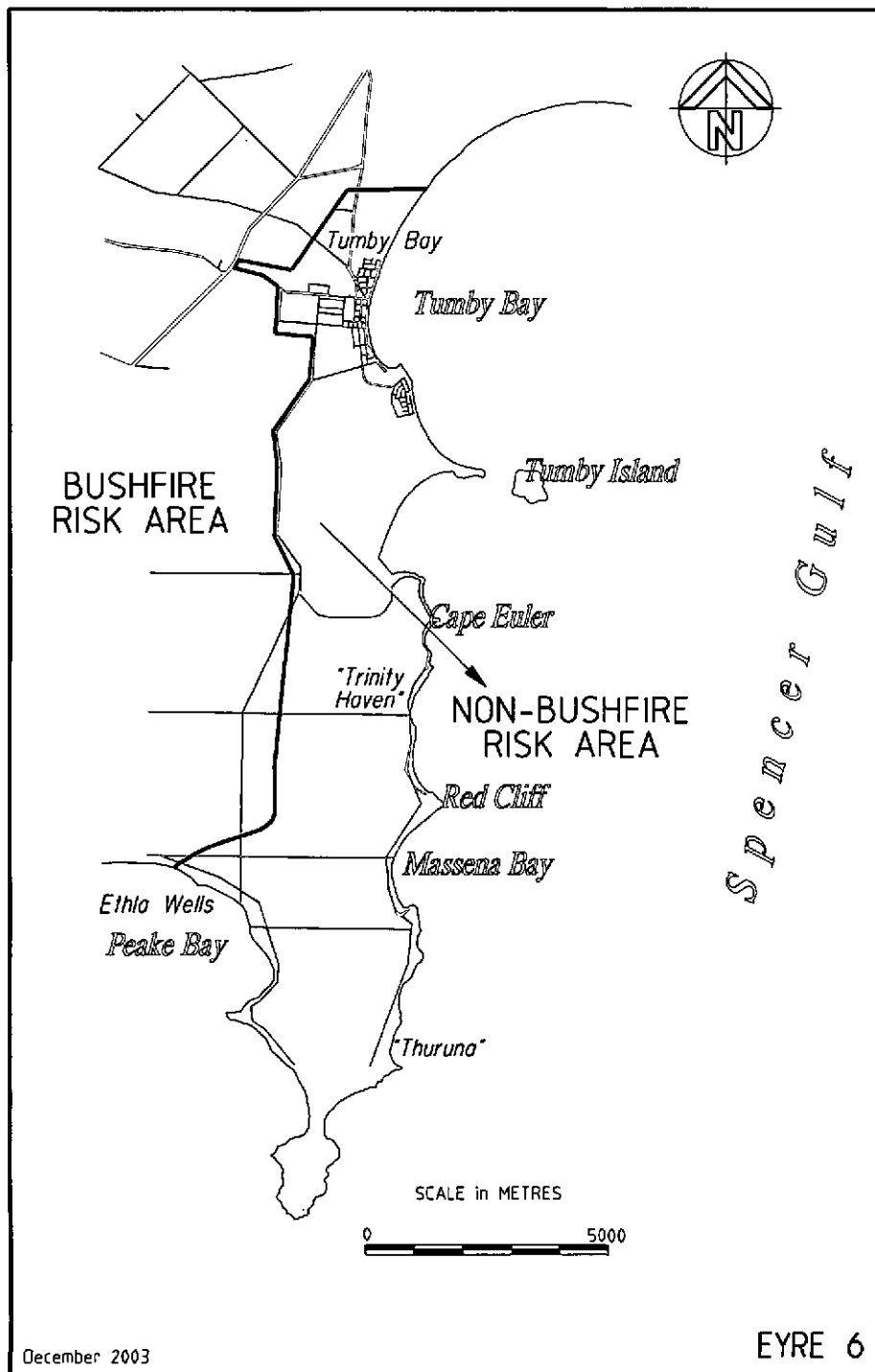

December 2003

EYRE 6

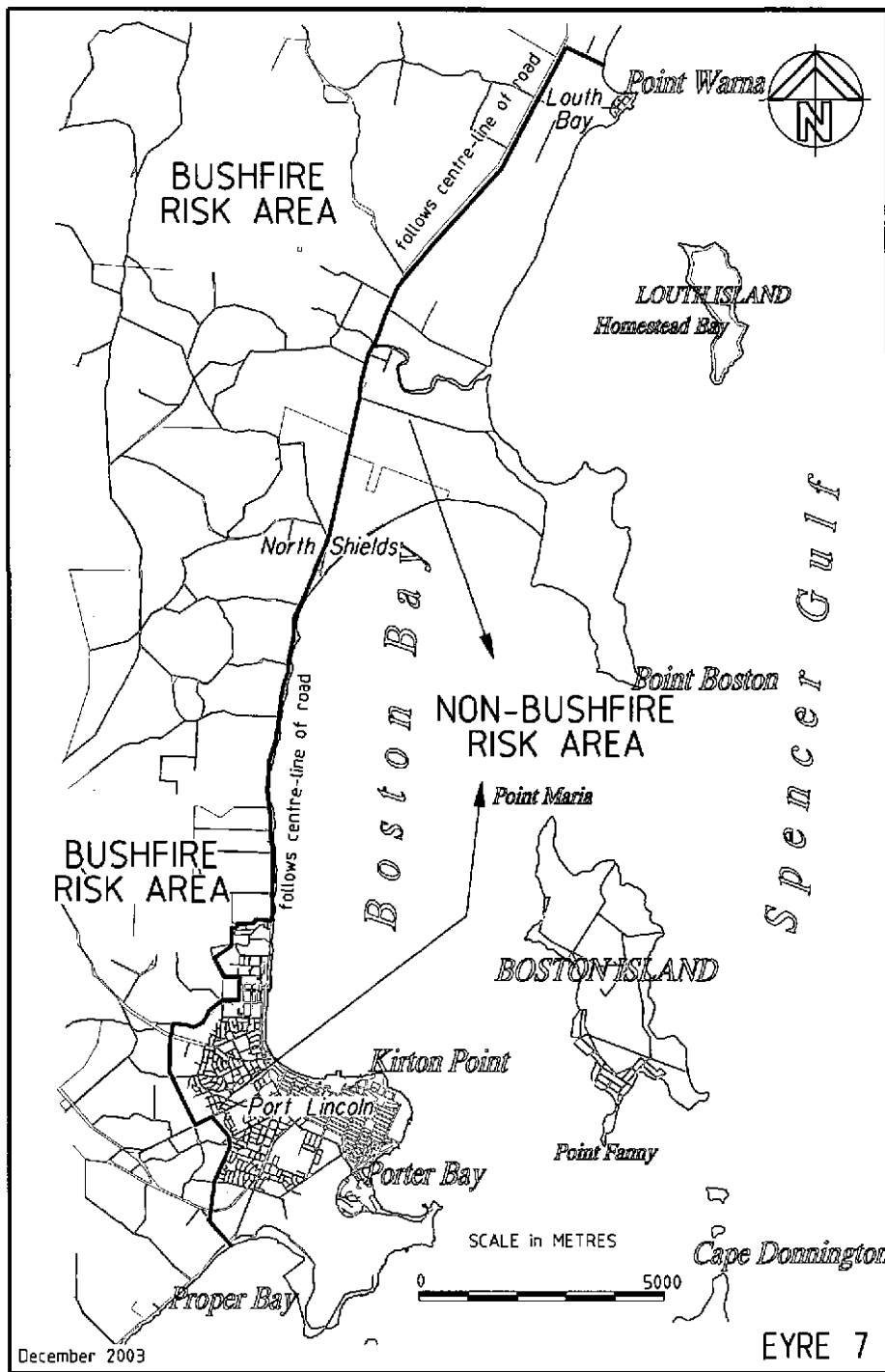

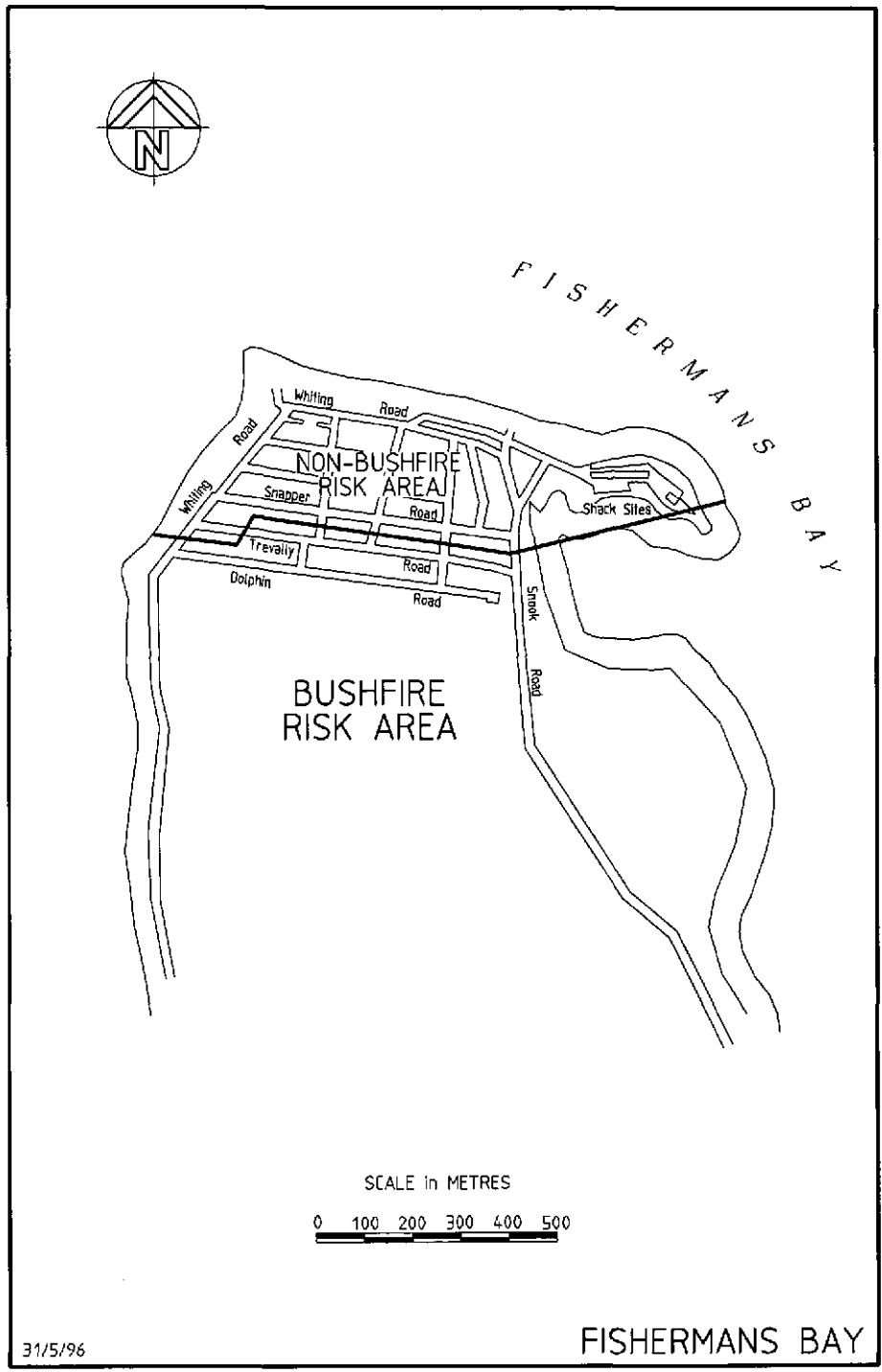

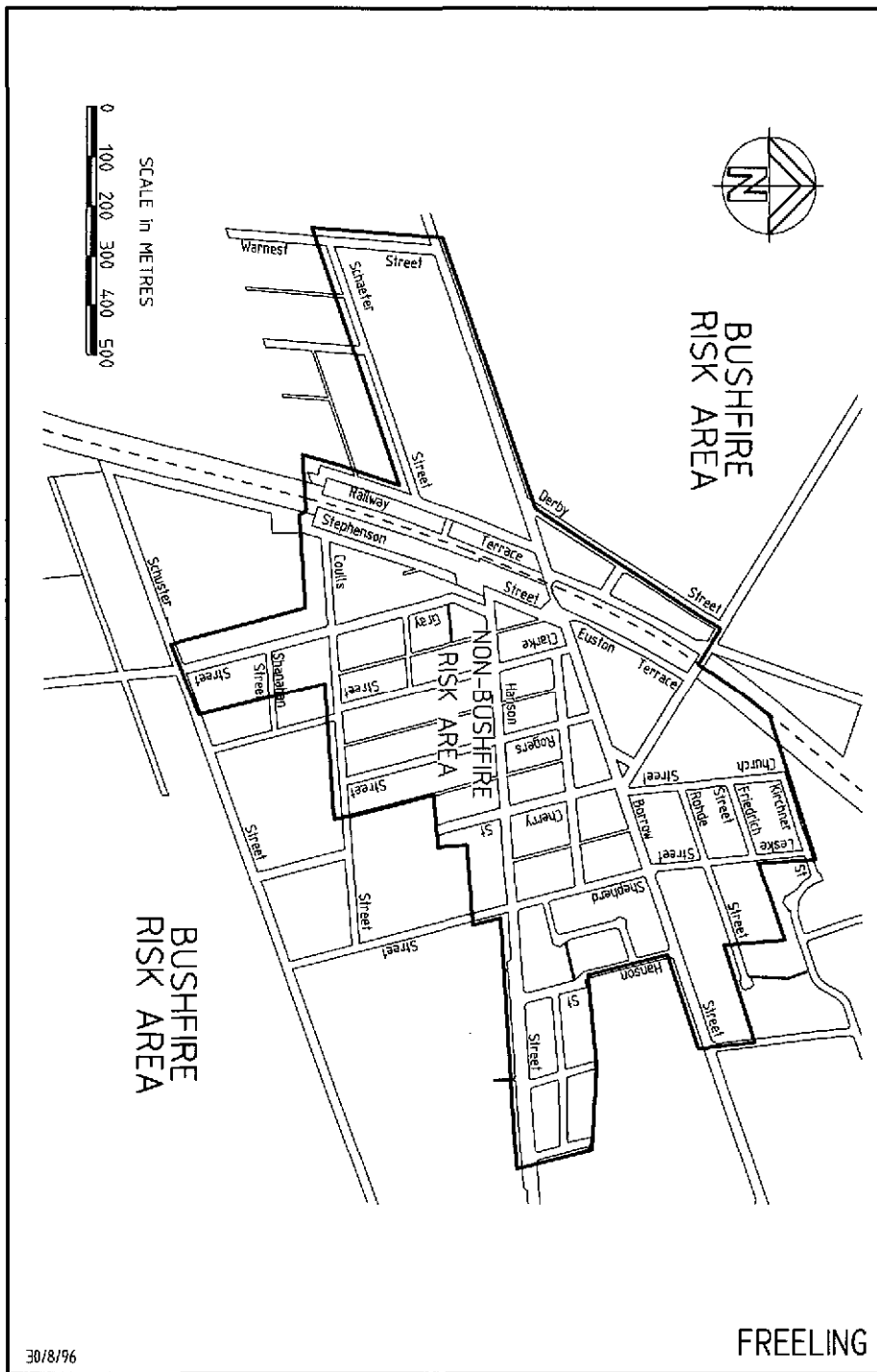

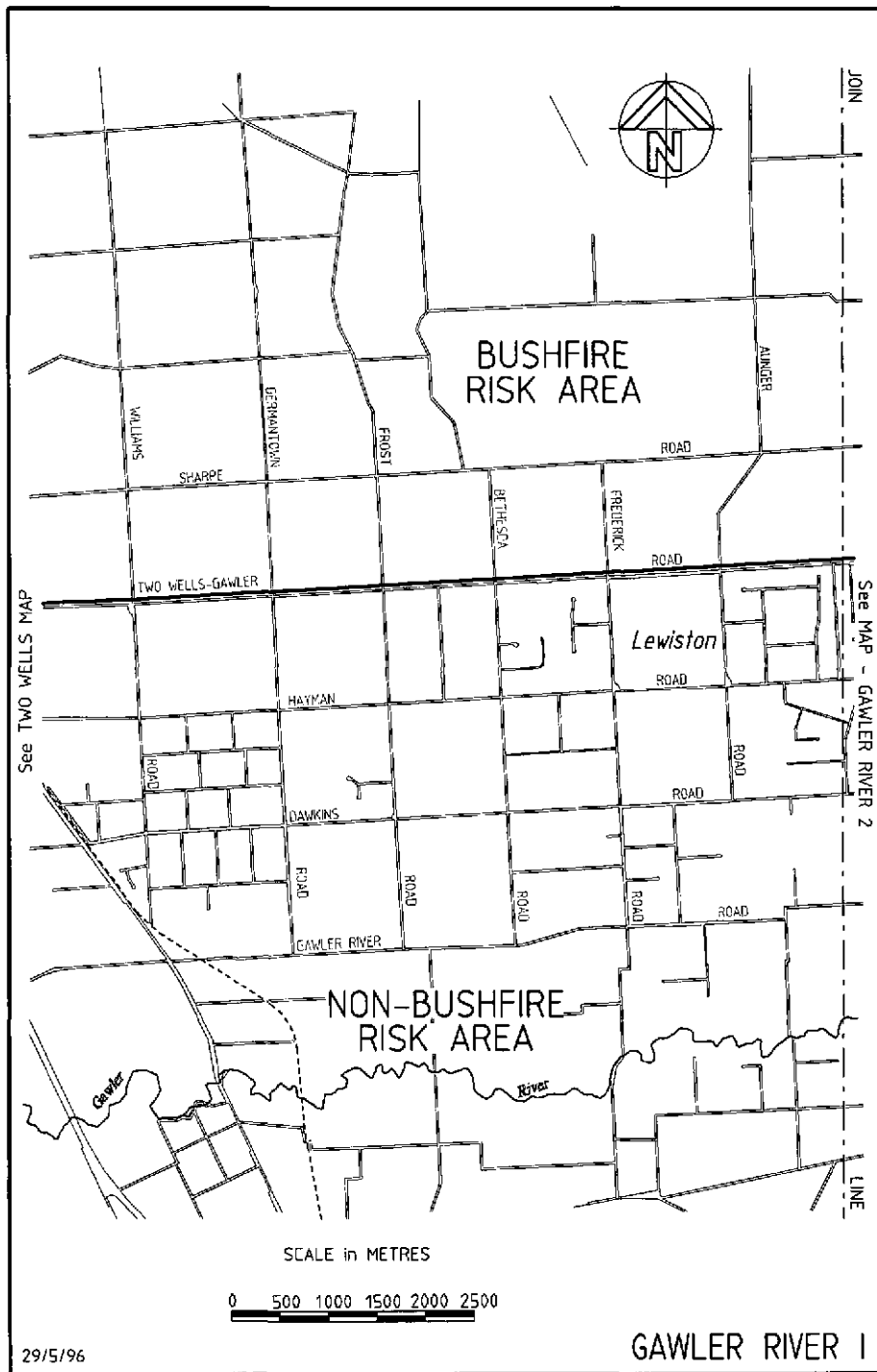

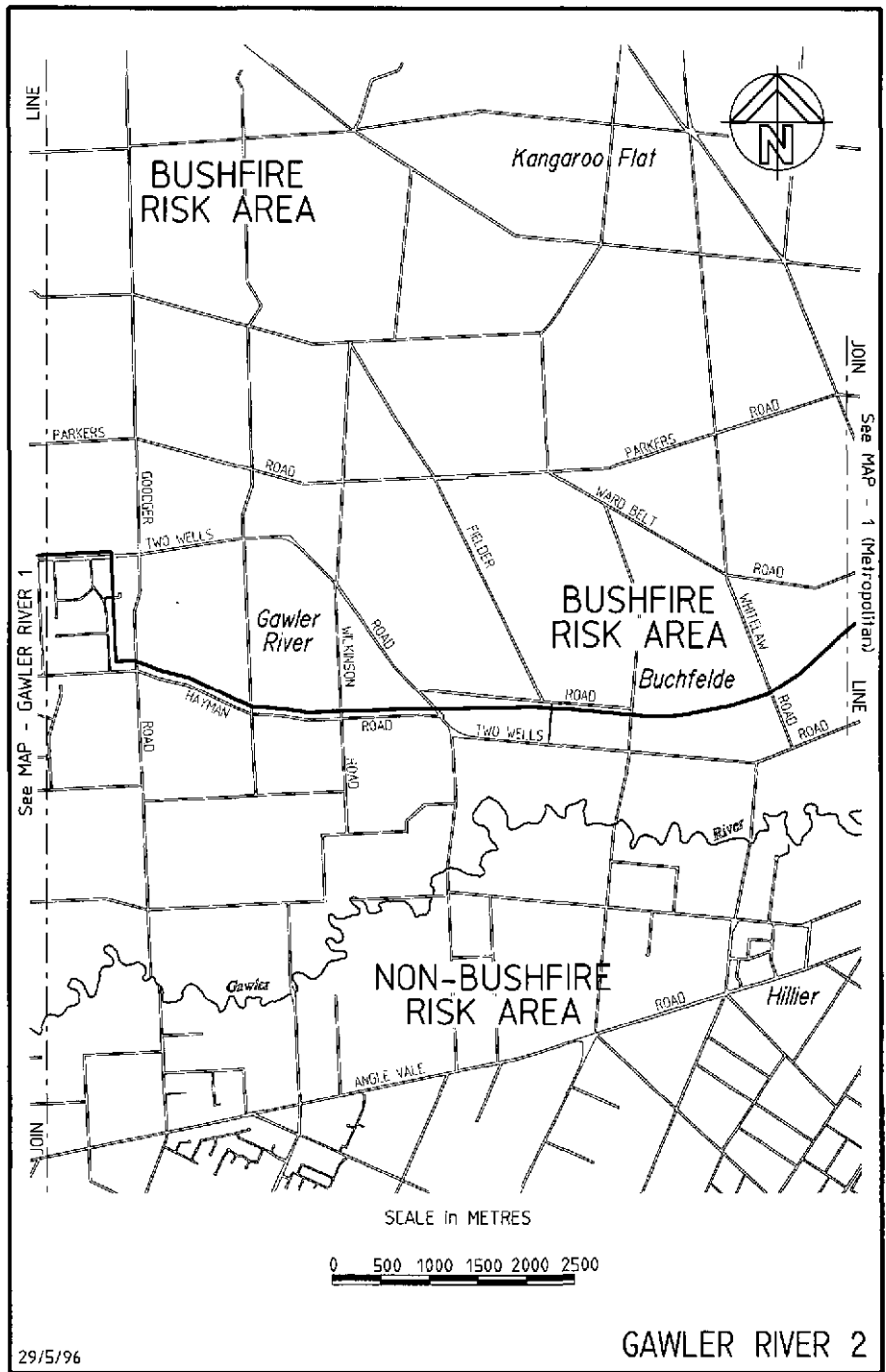

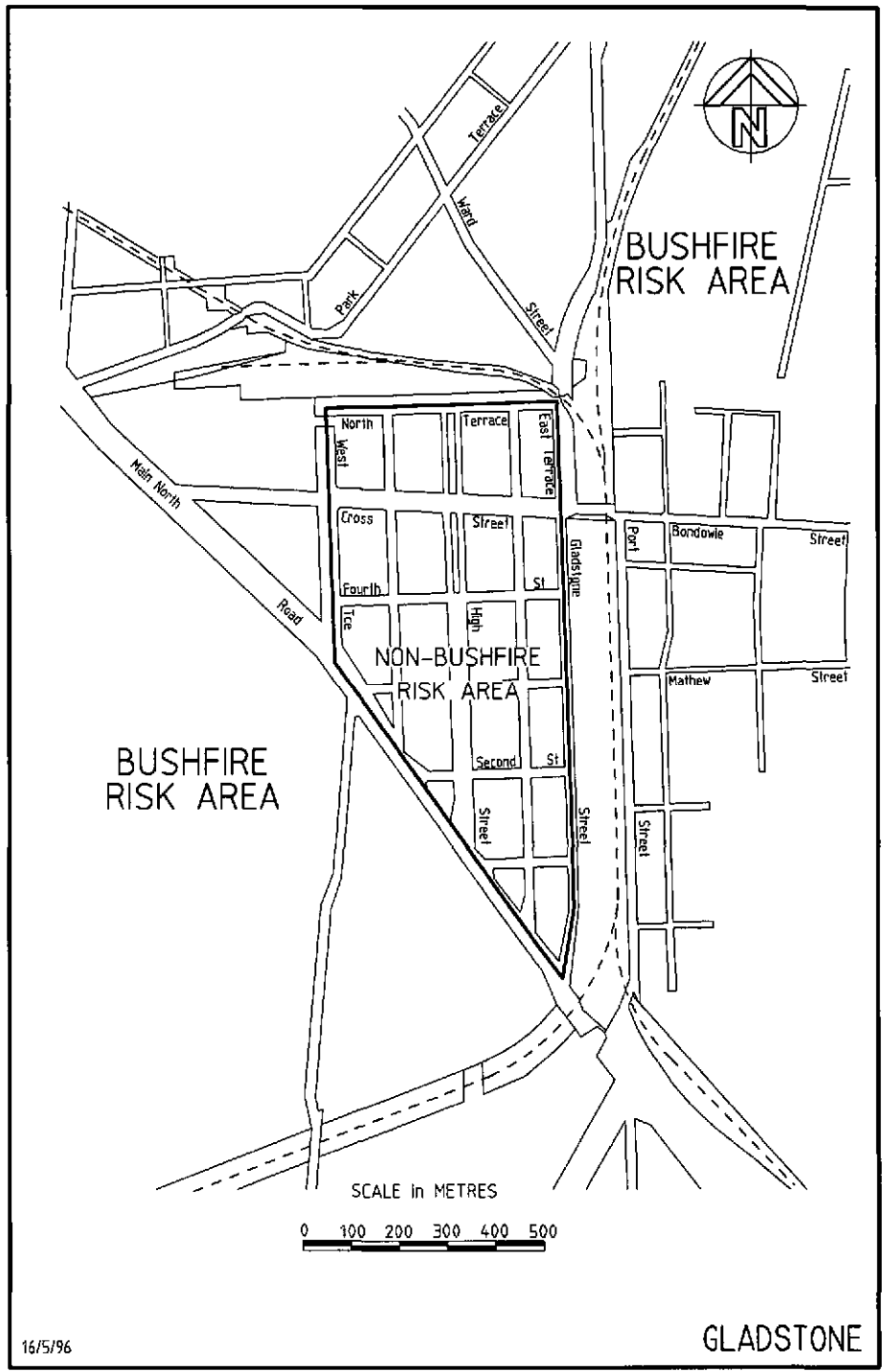

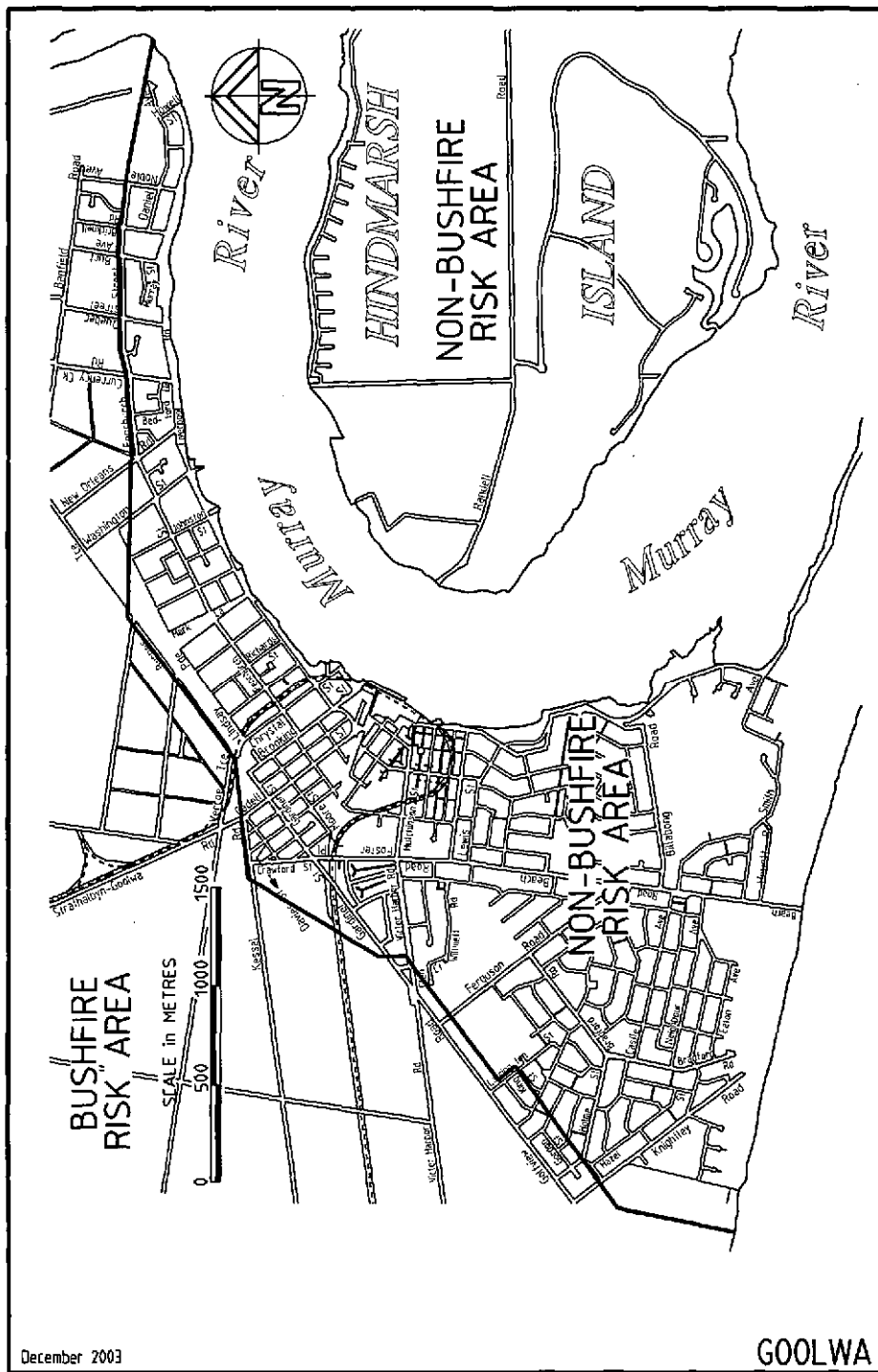

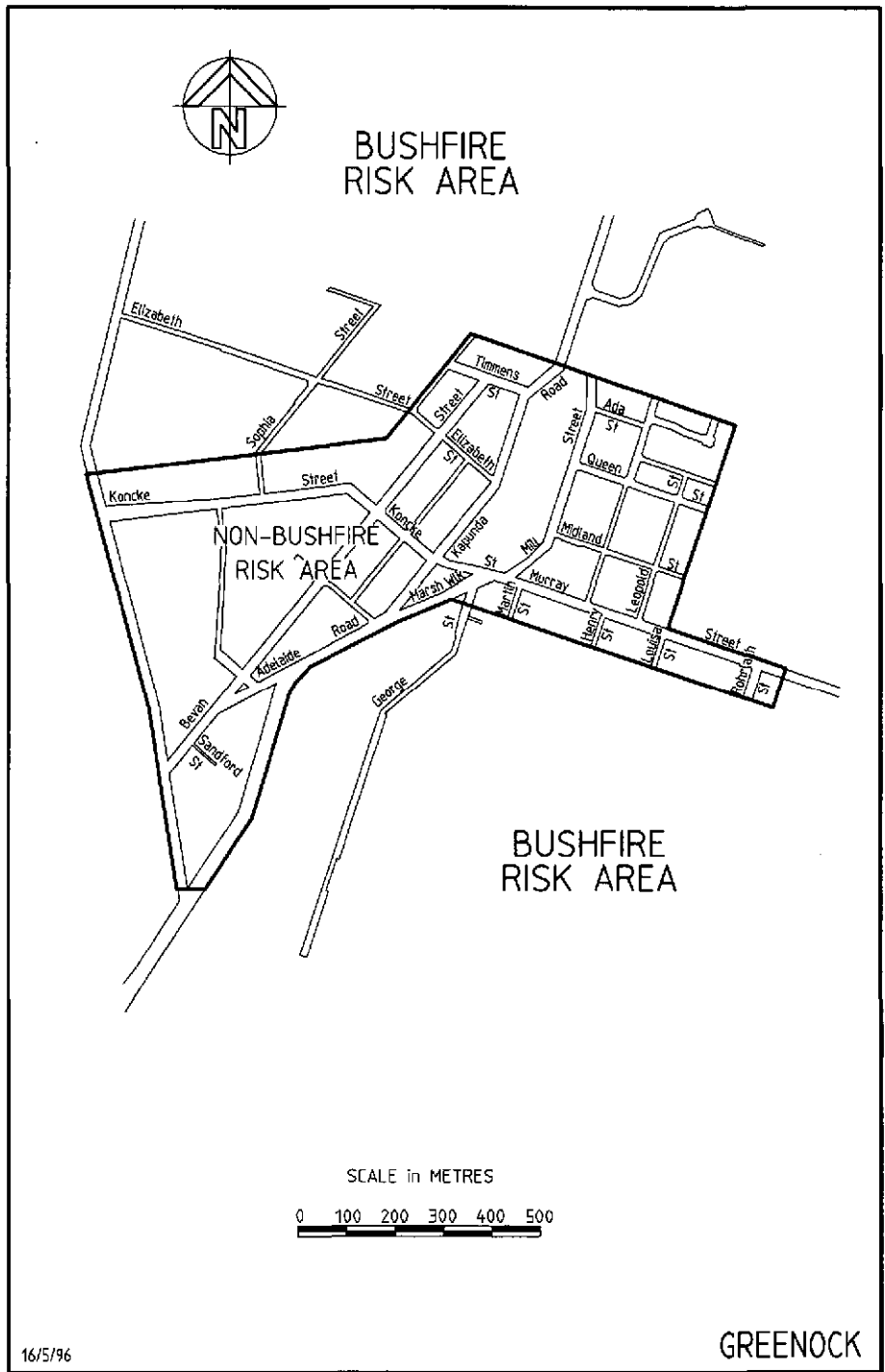

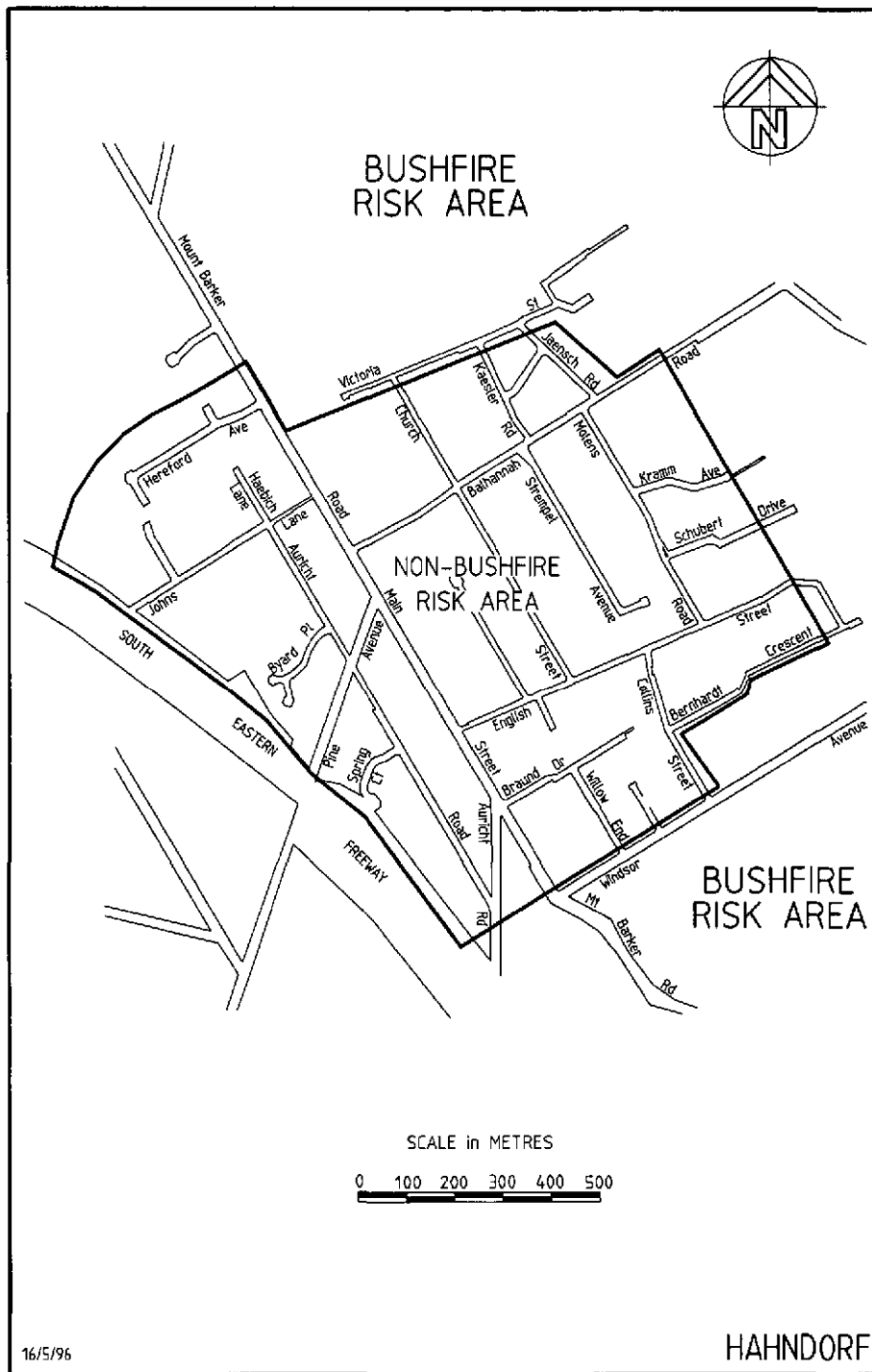

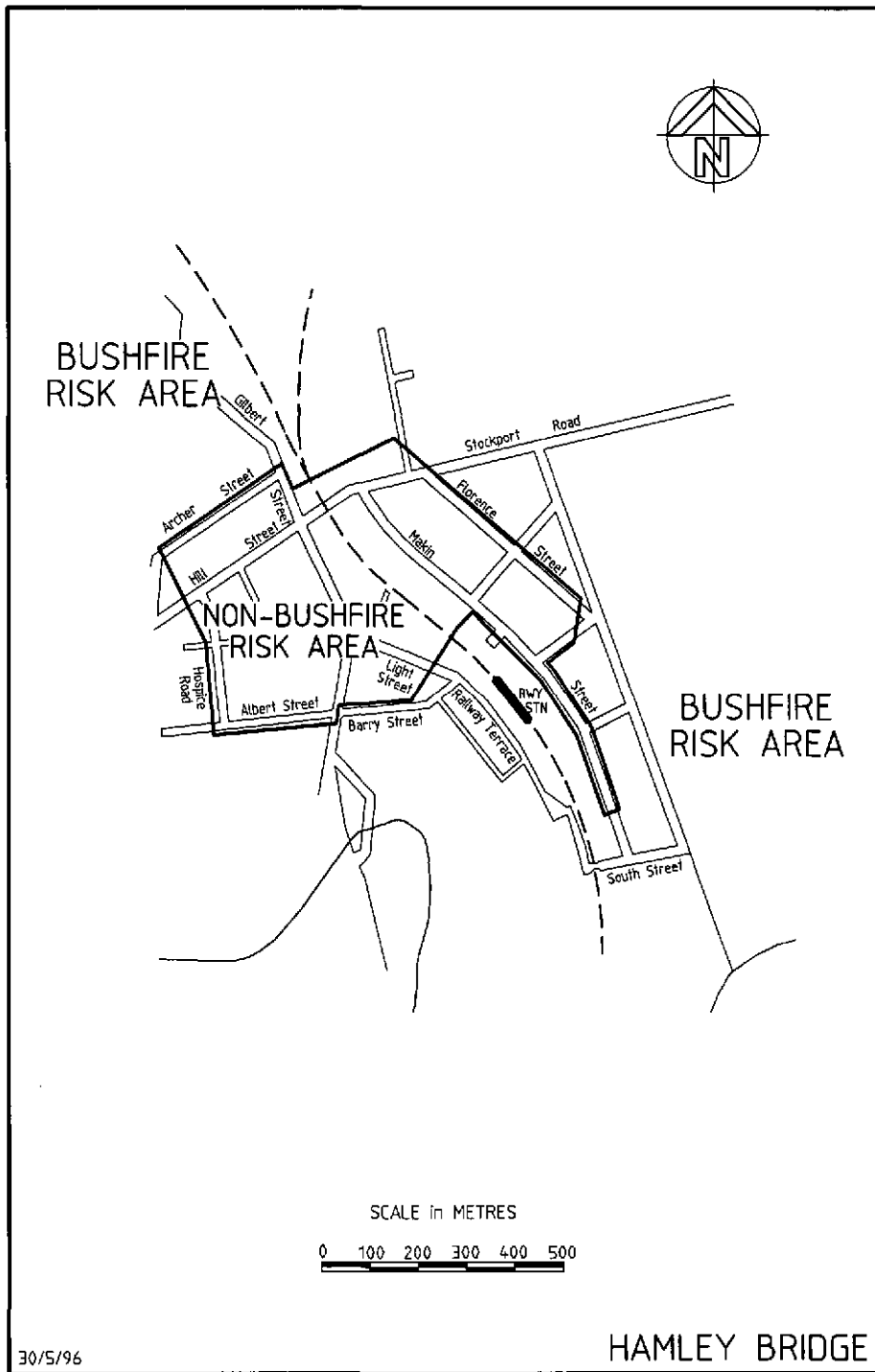

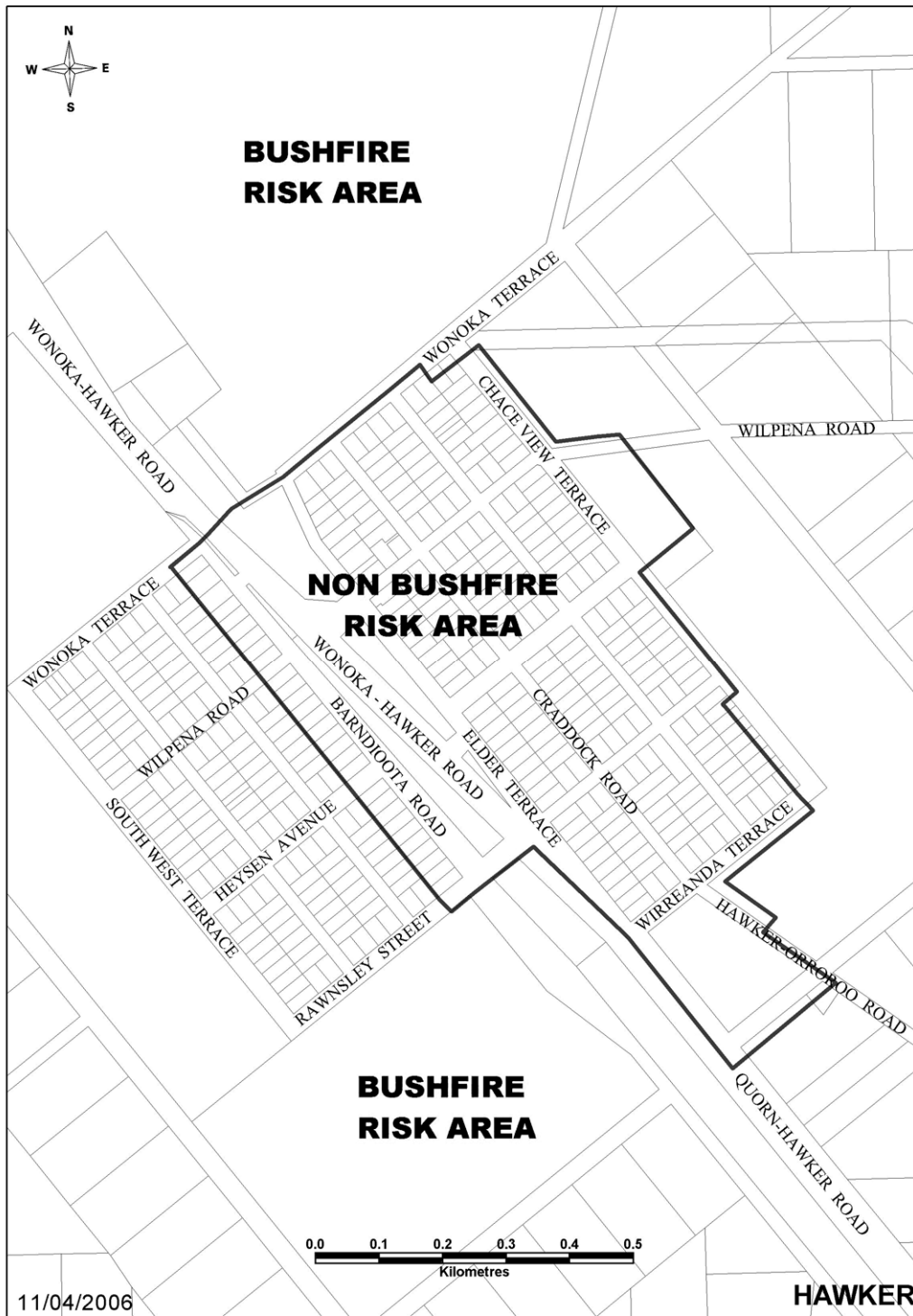

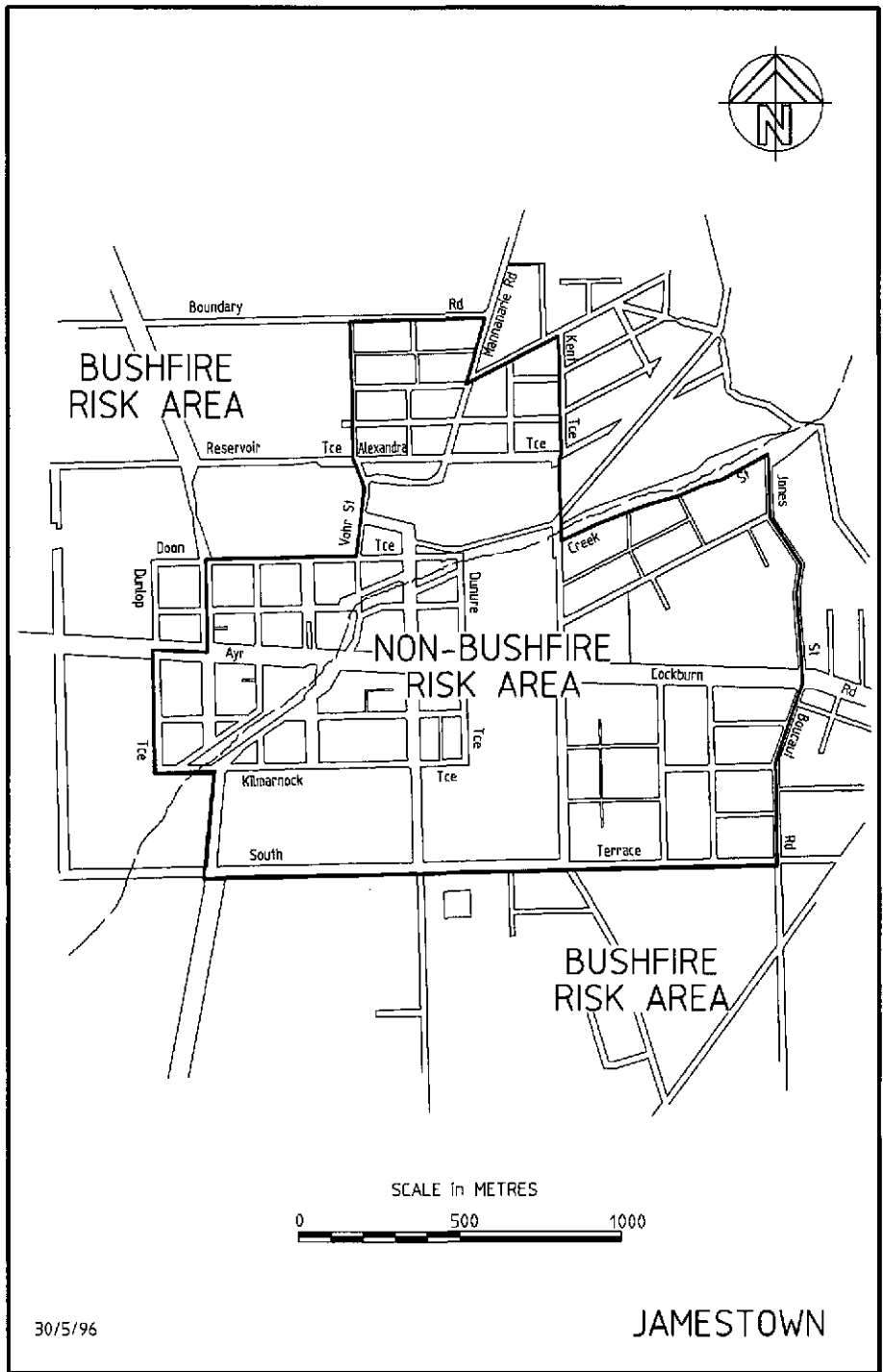

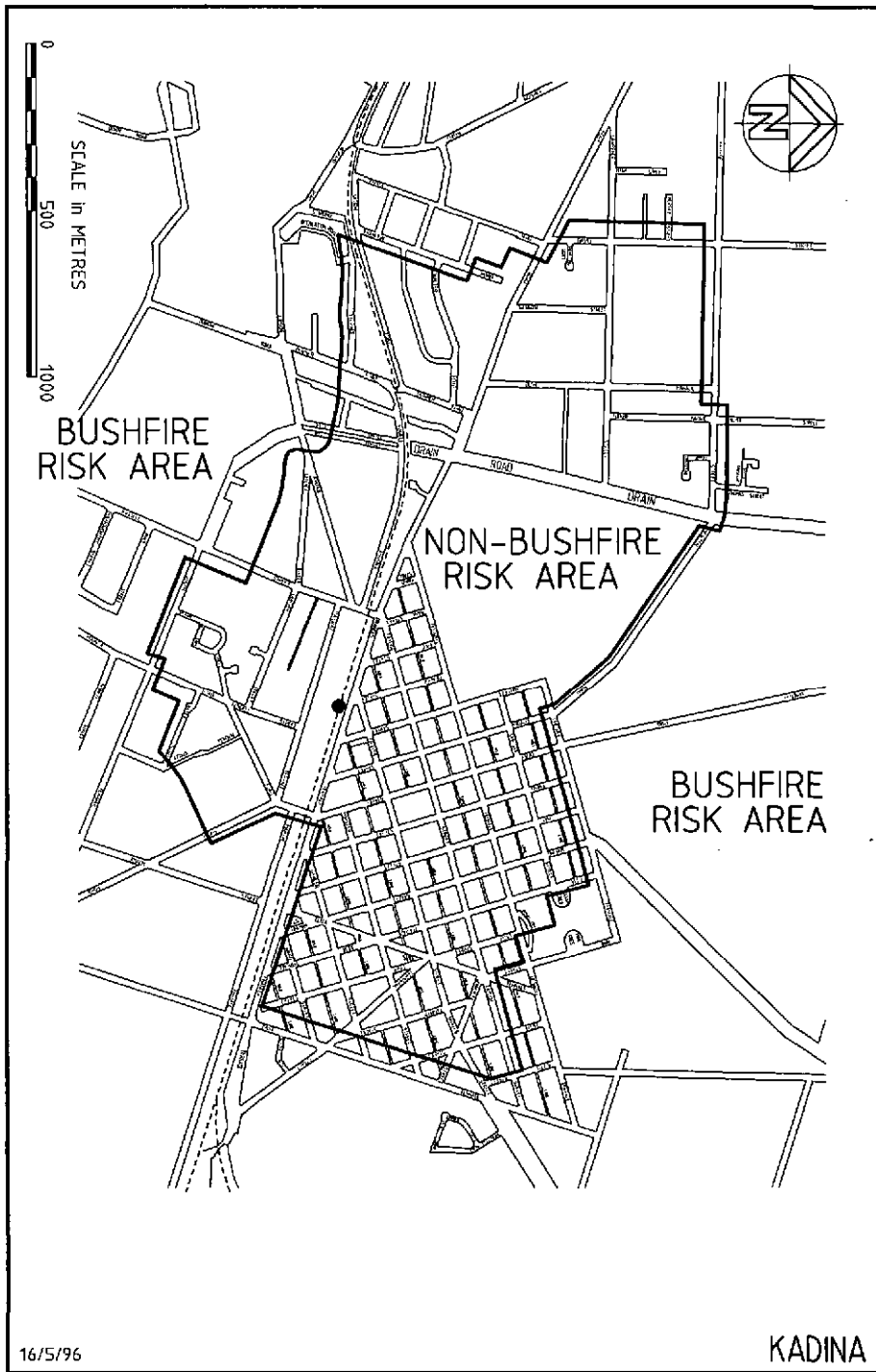

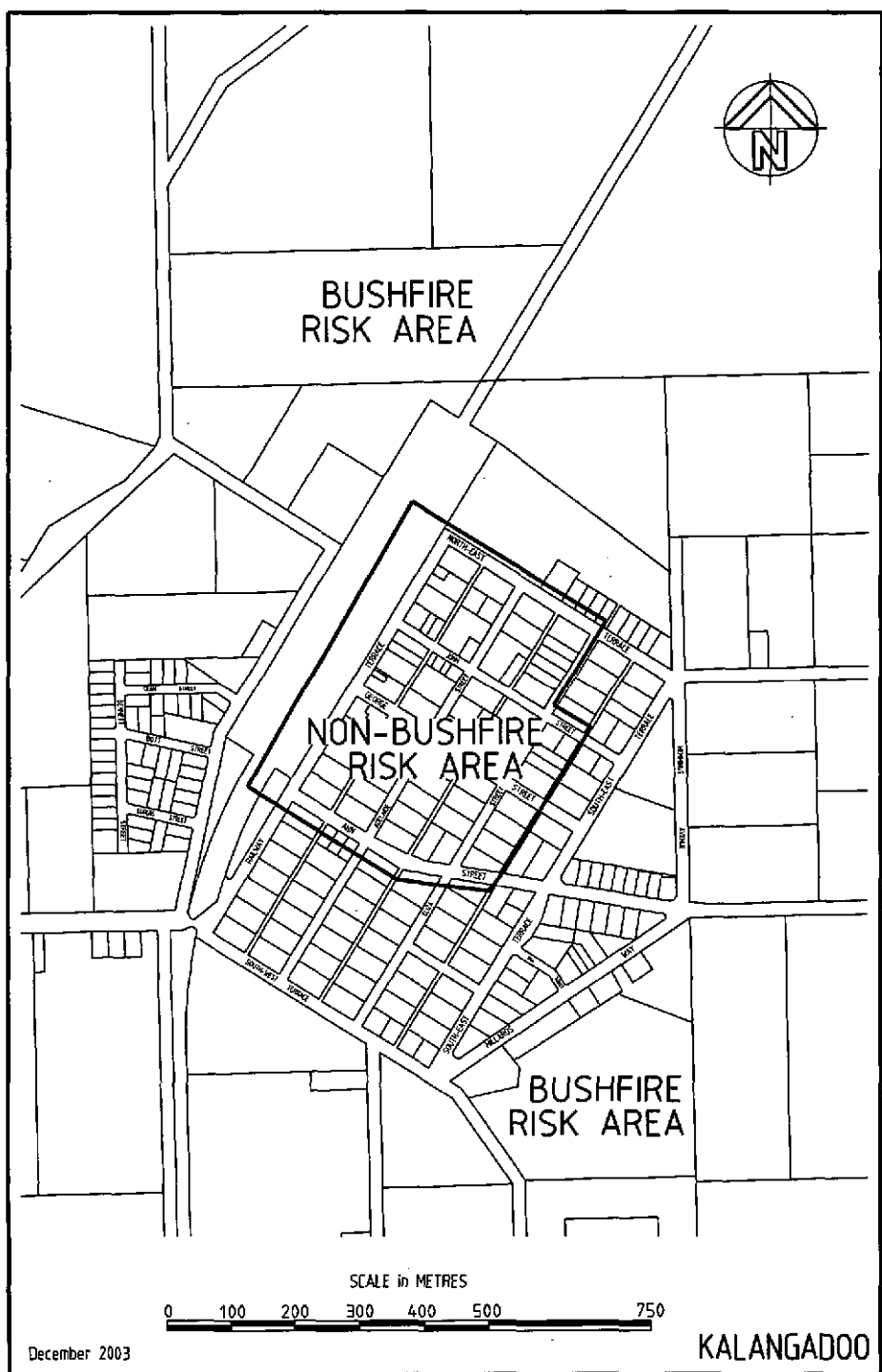

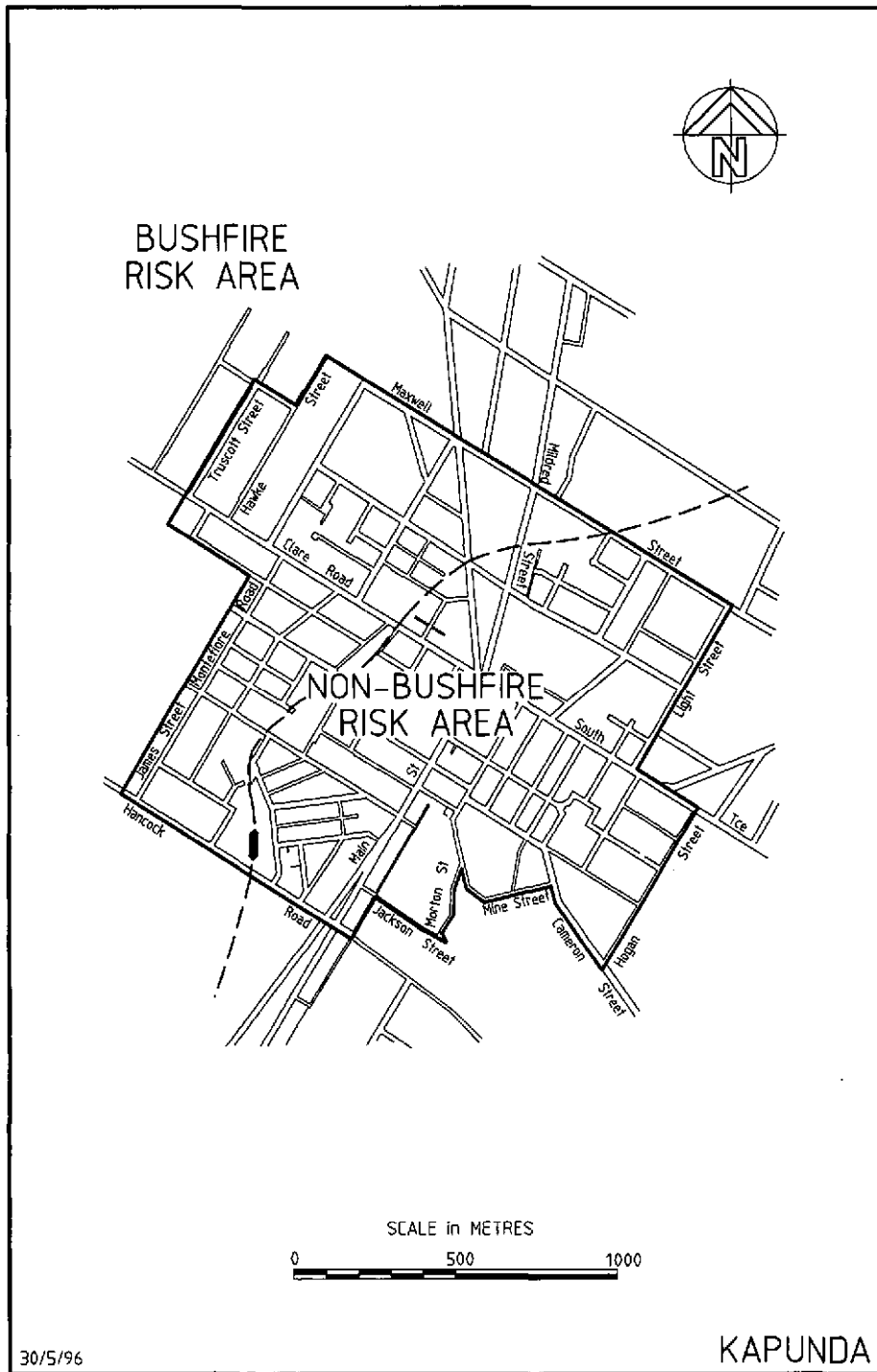

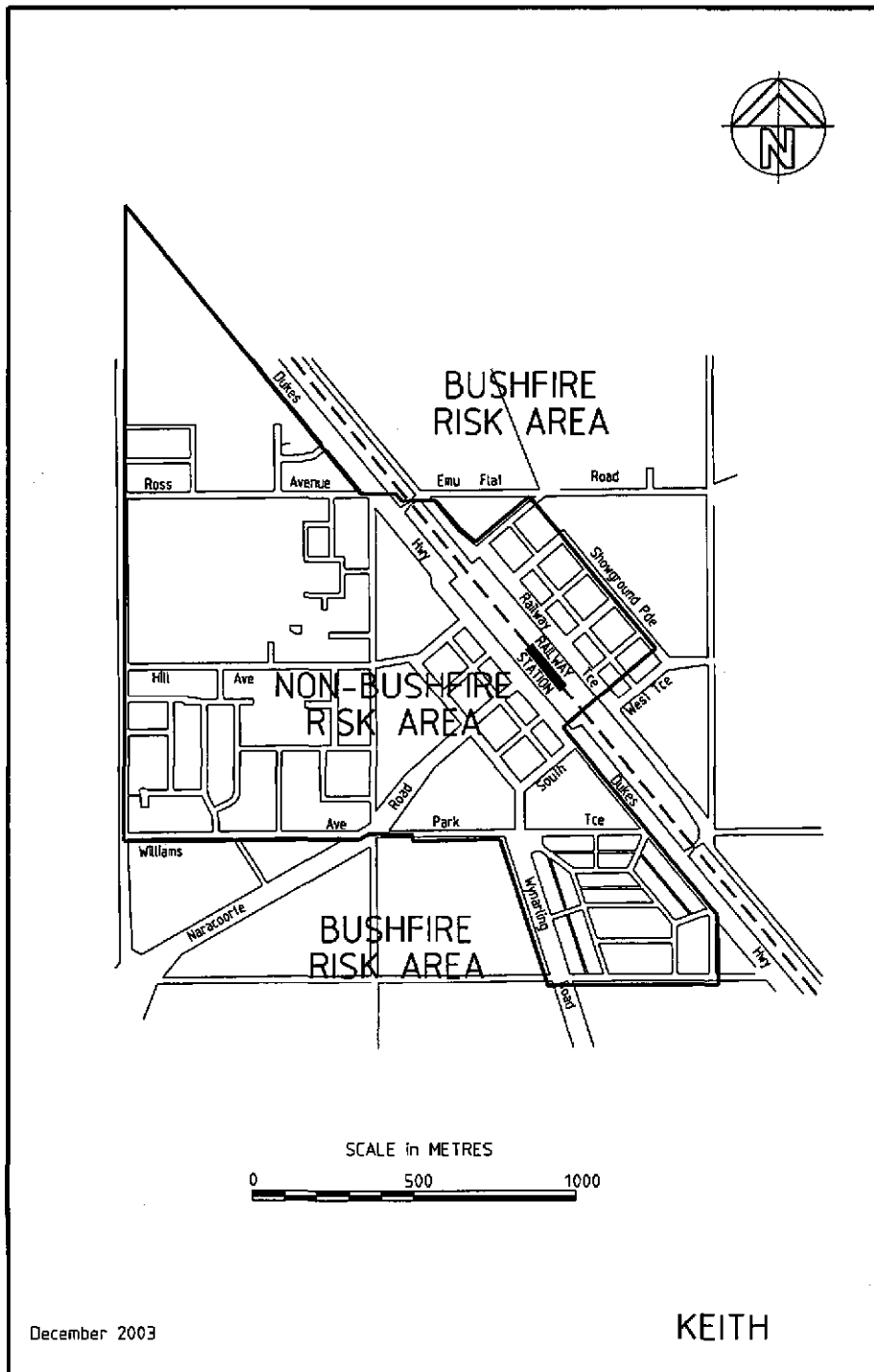

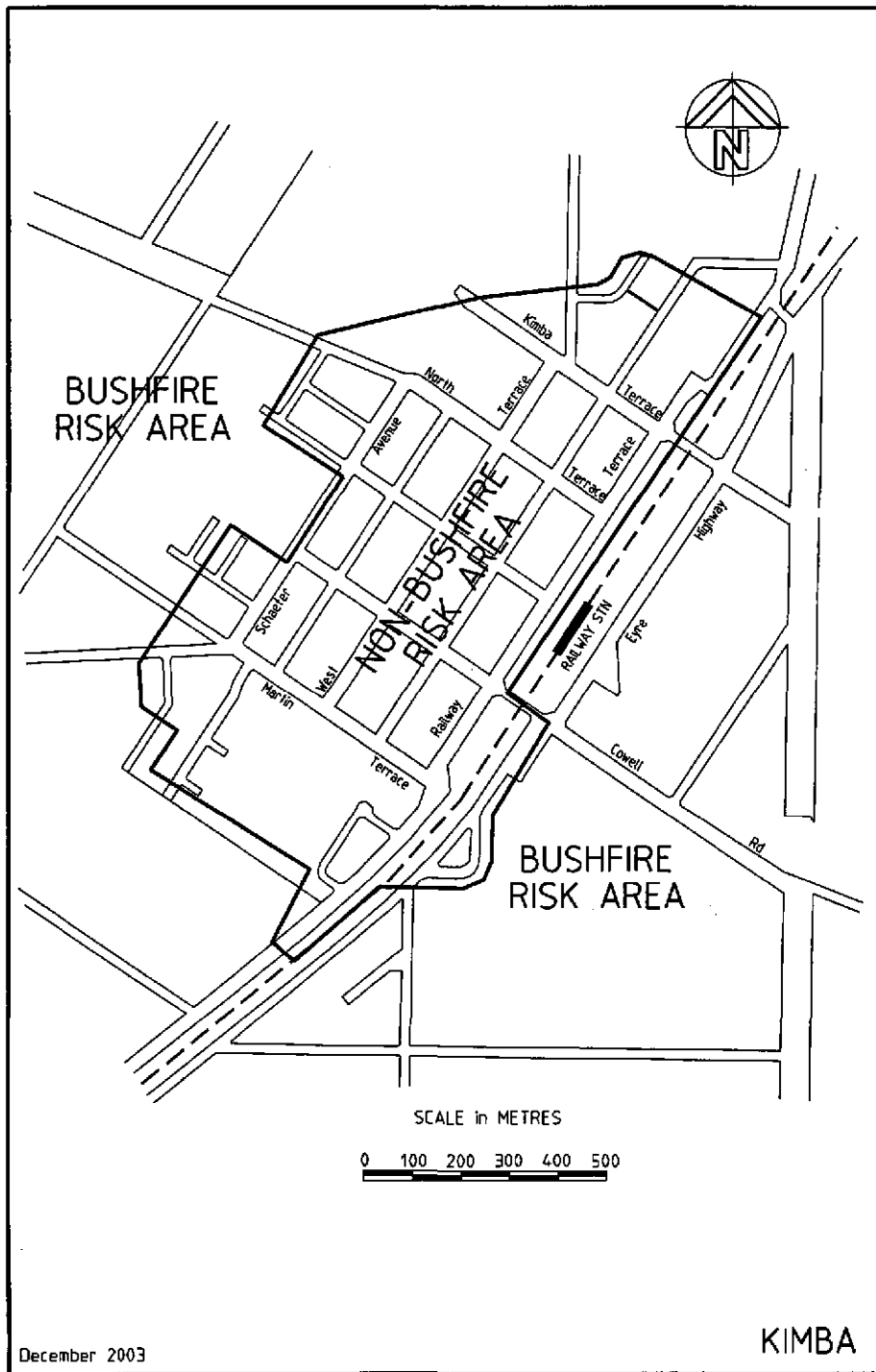

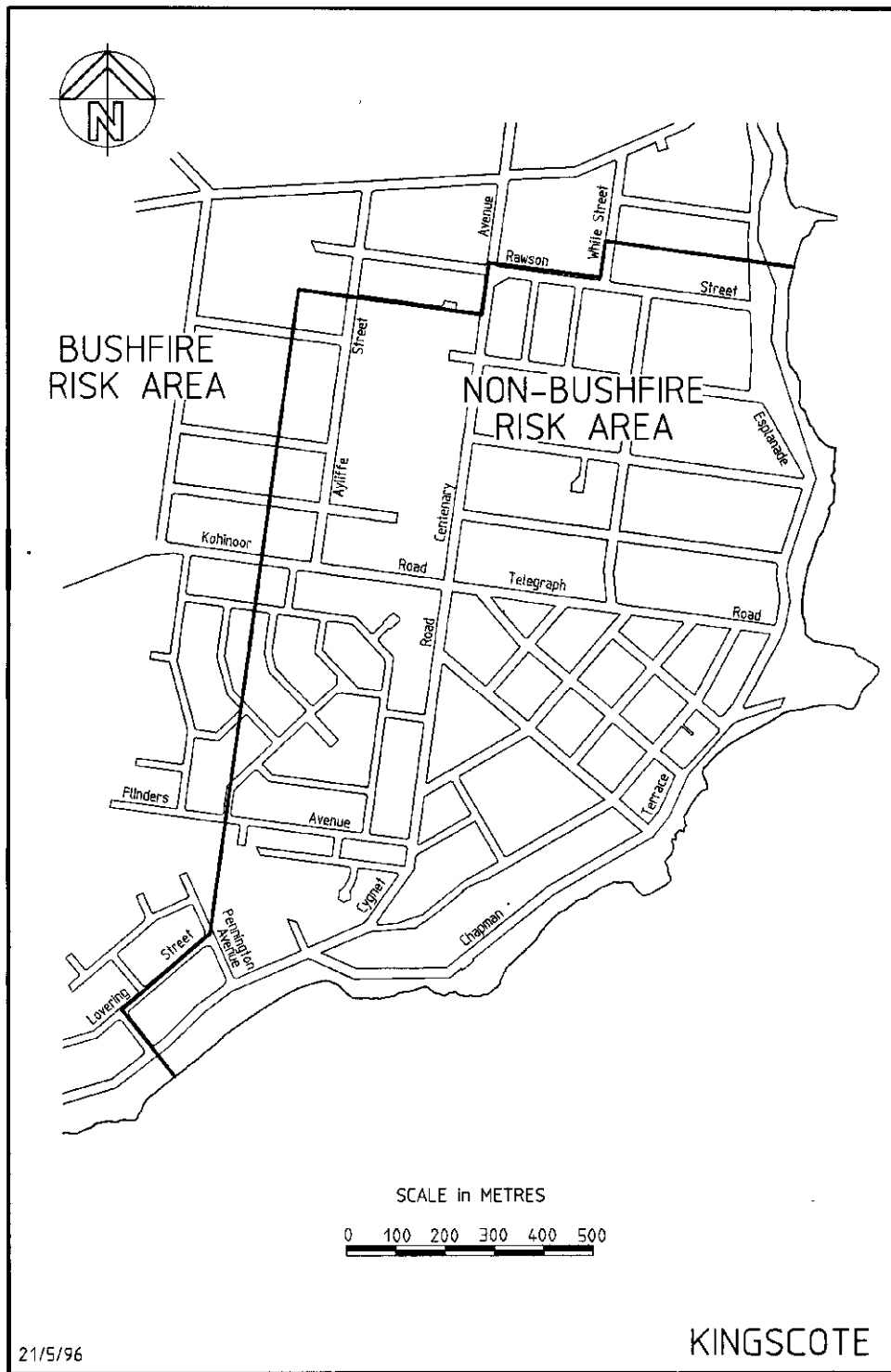

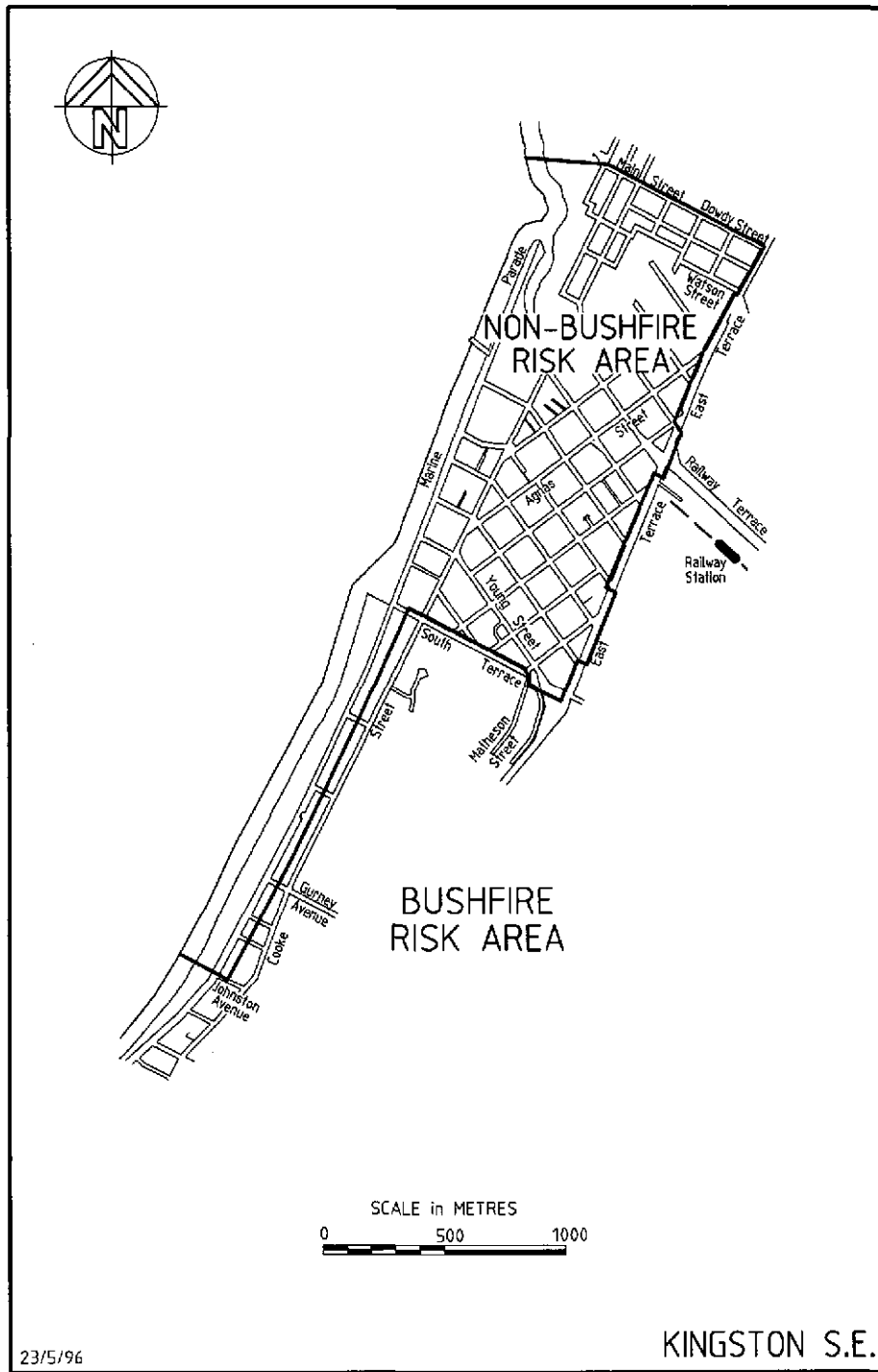

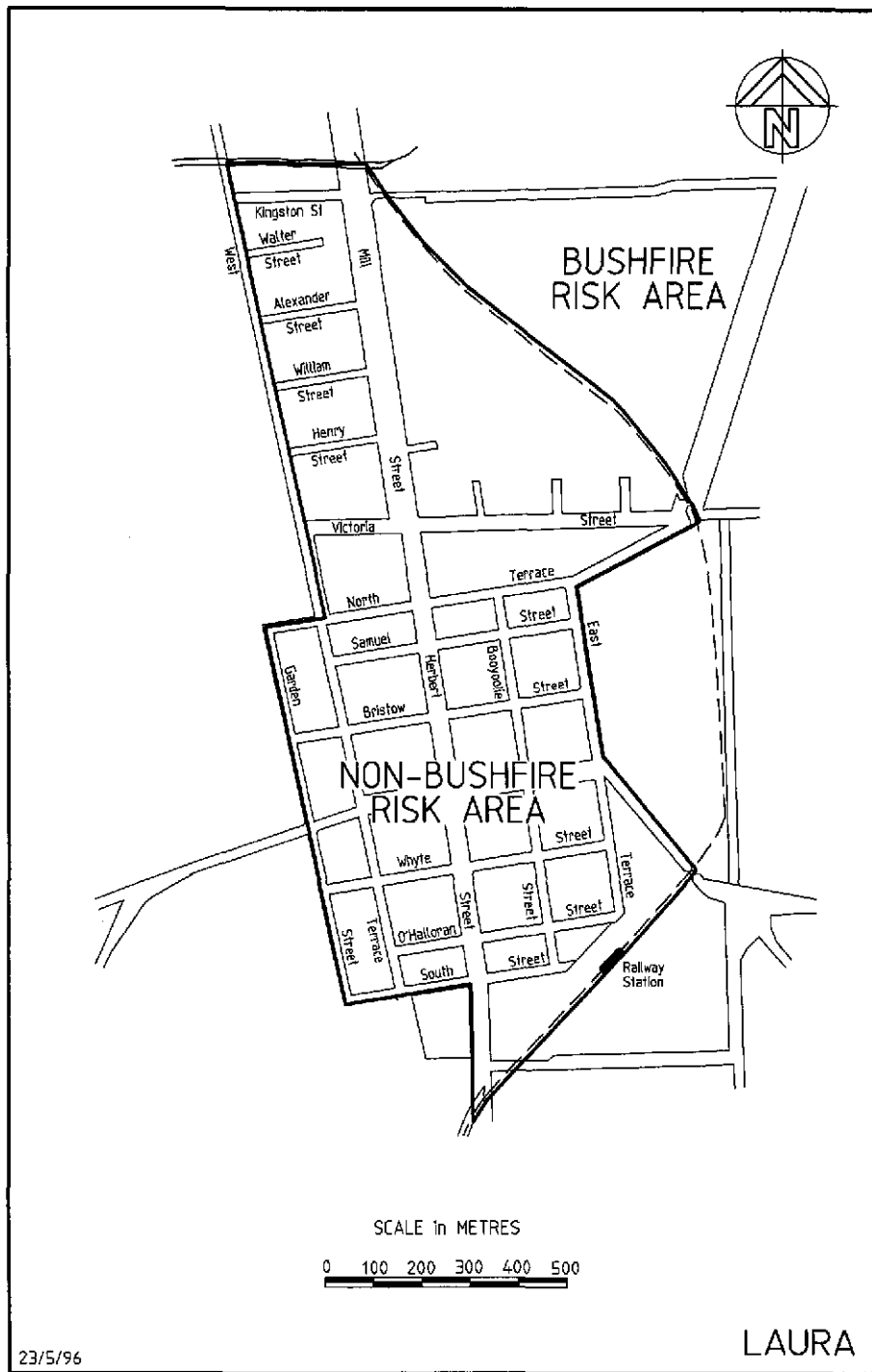

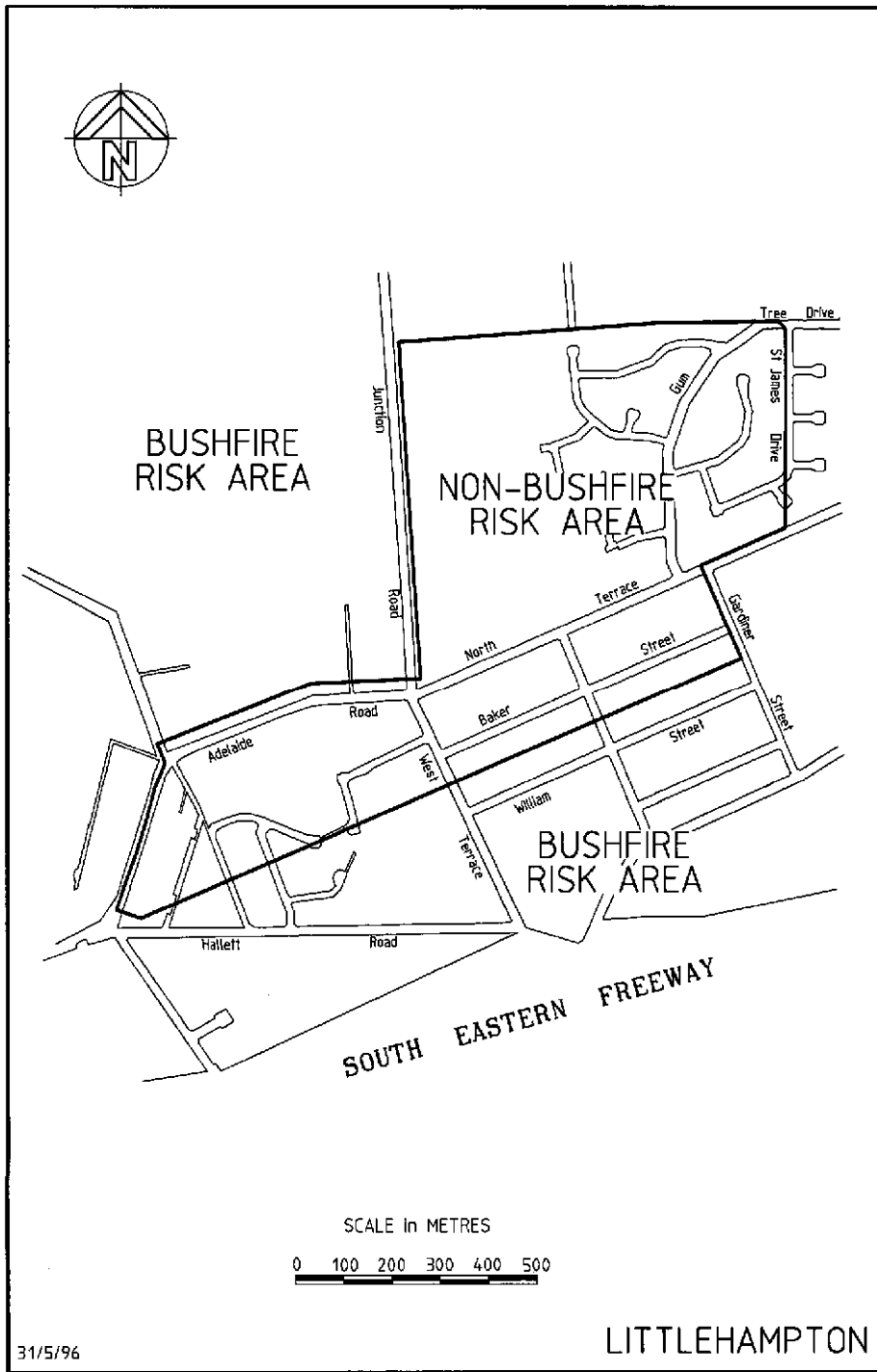

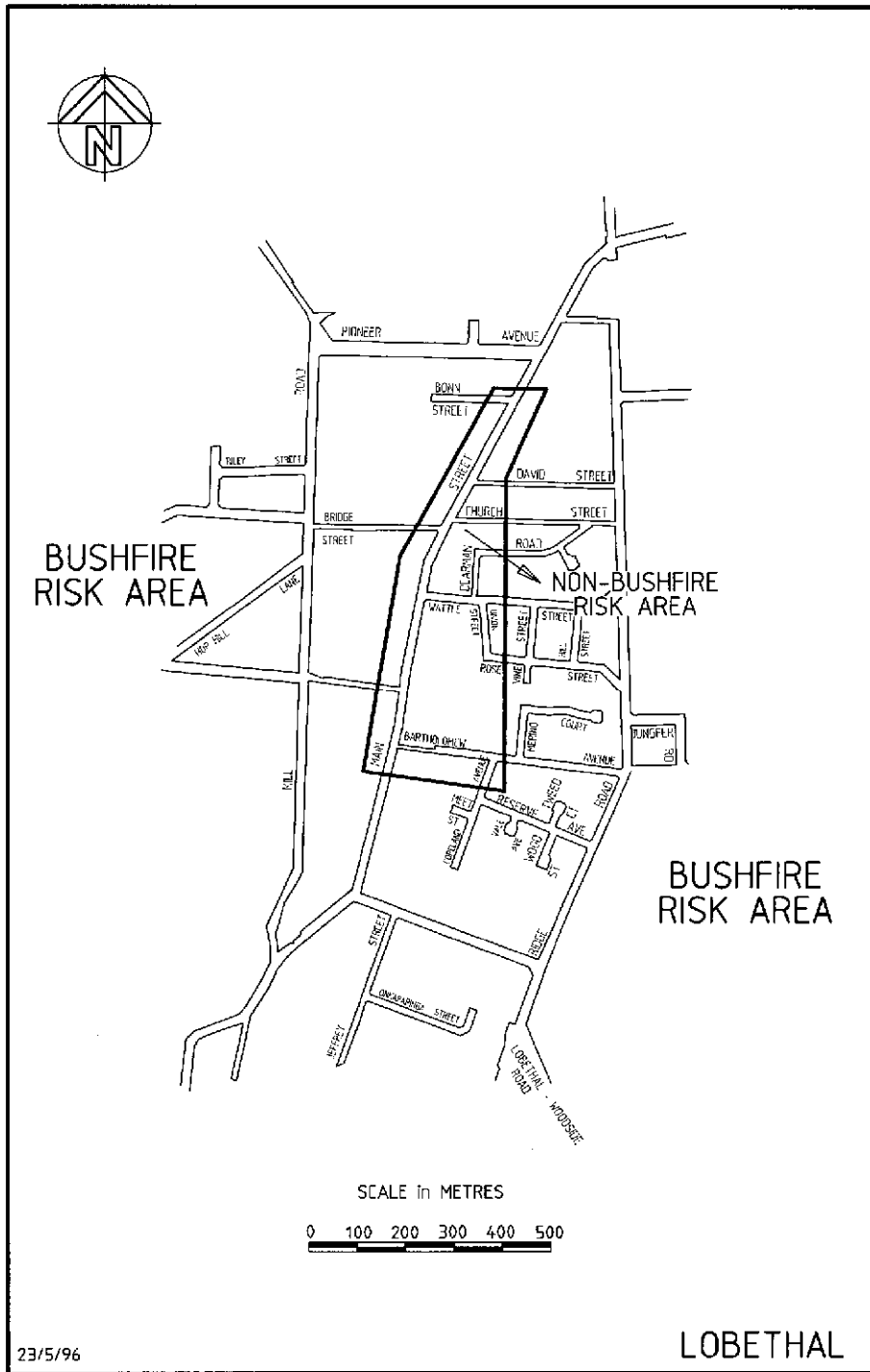

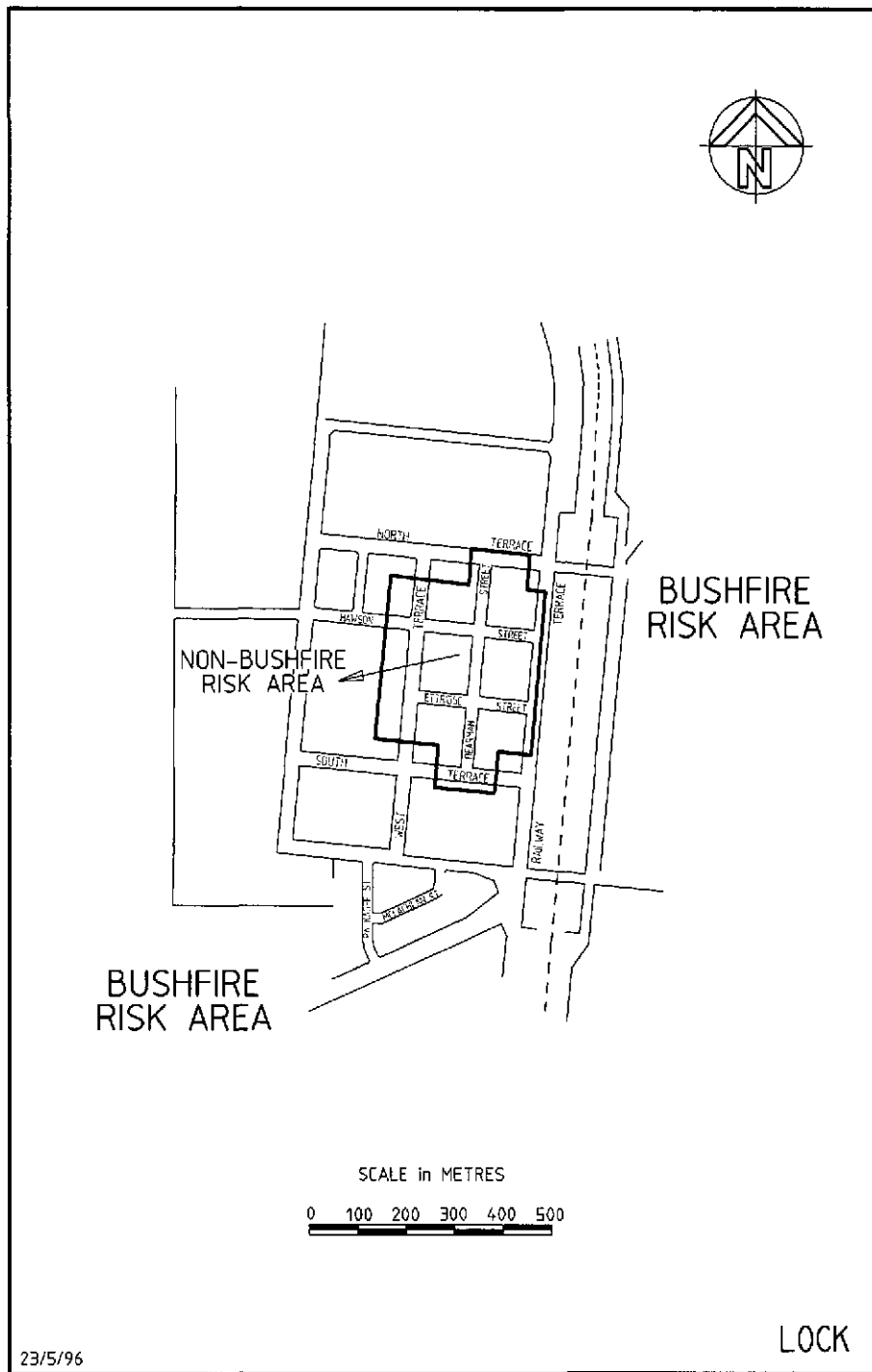

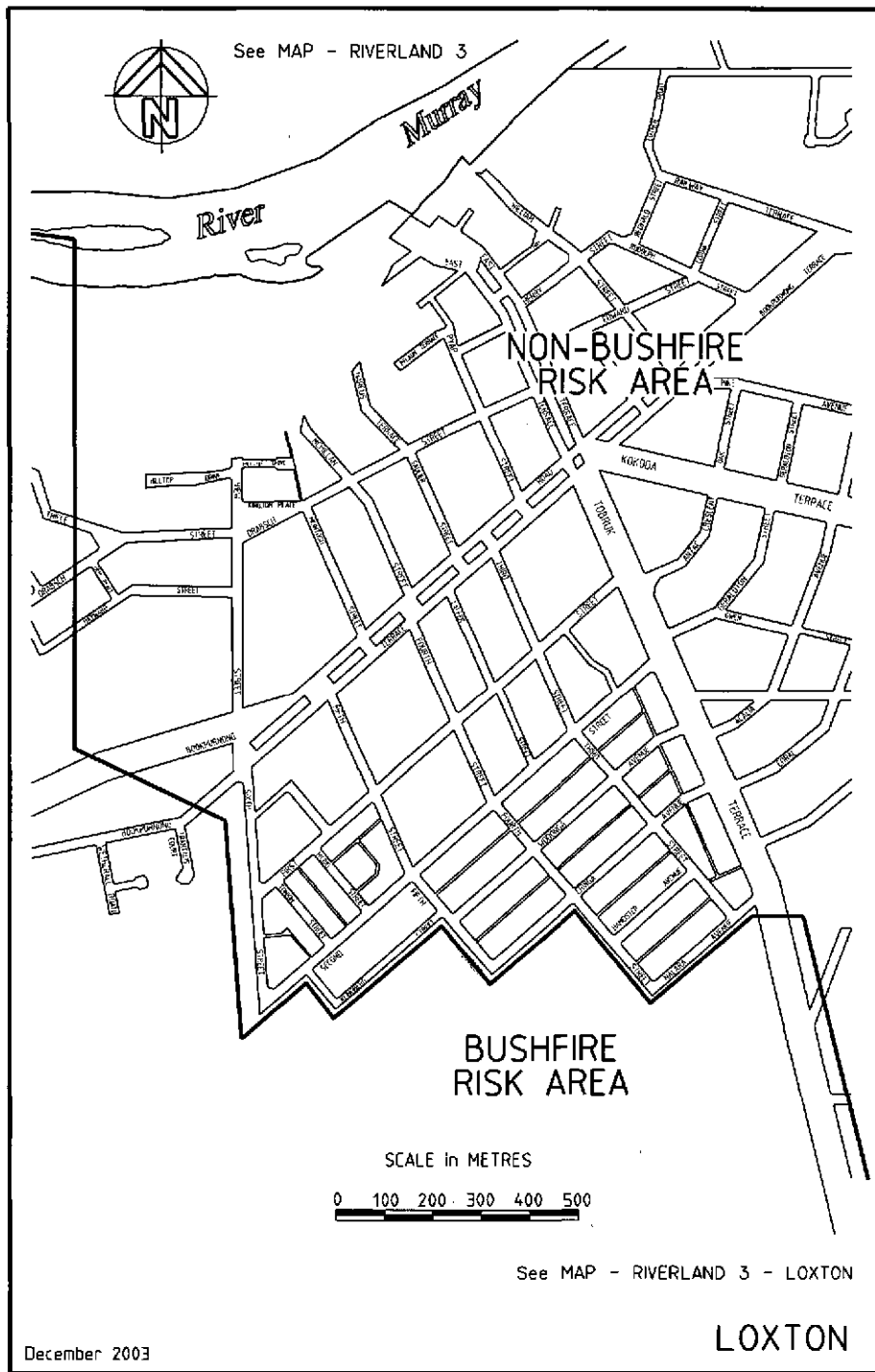

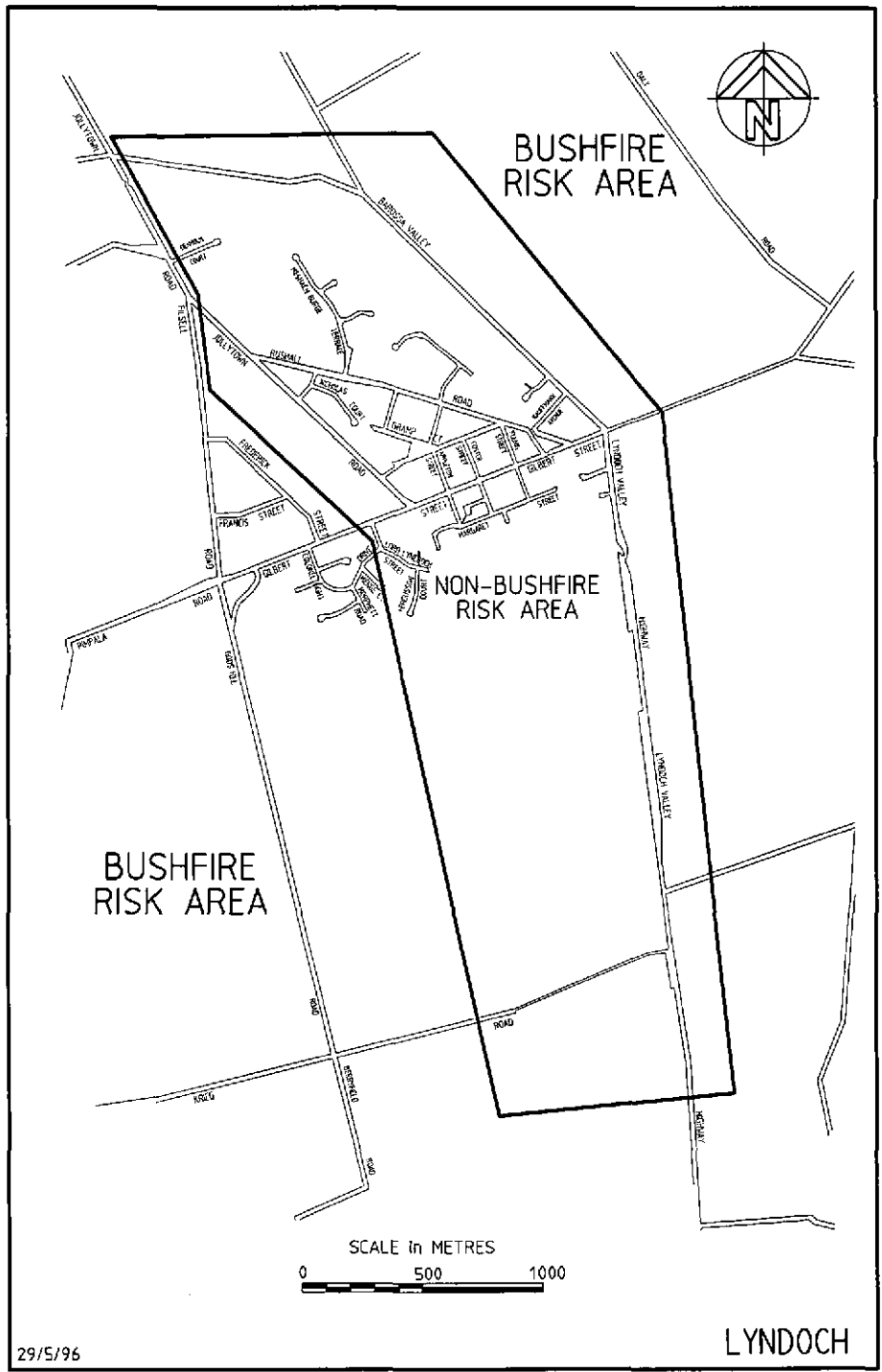

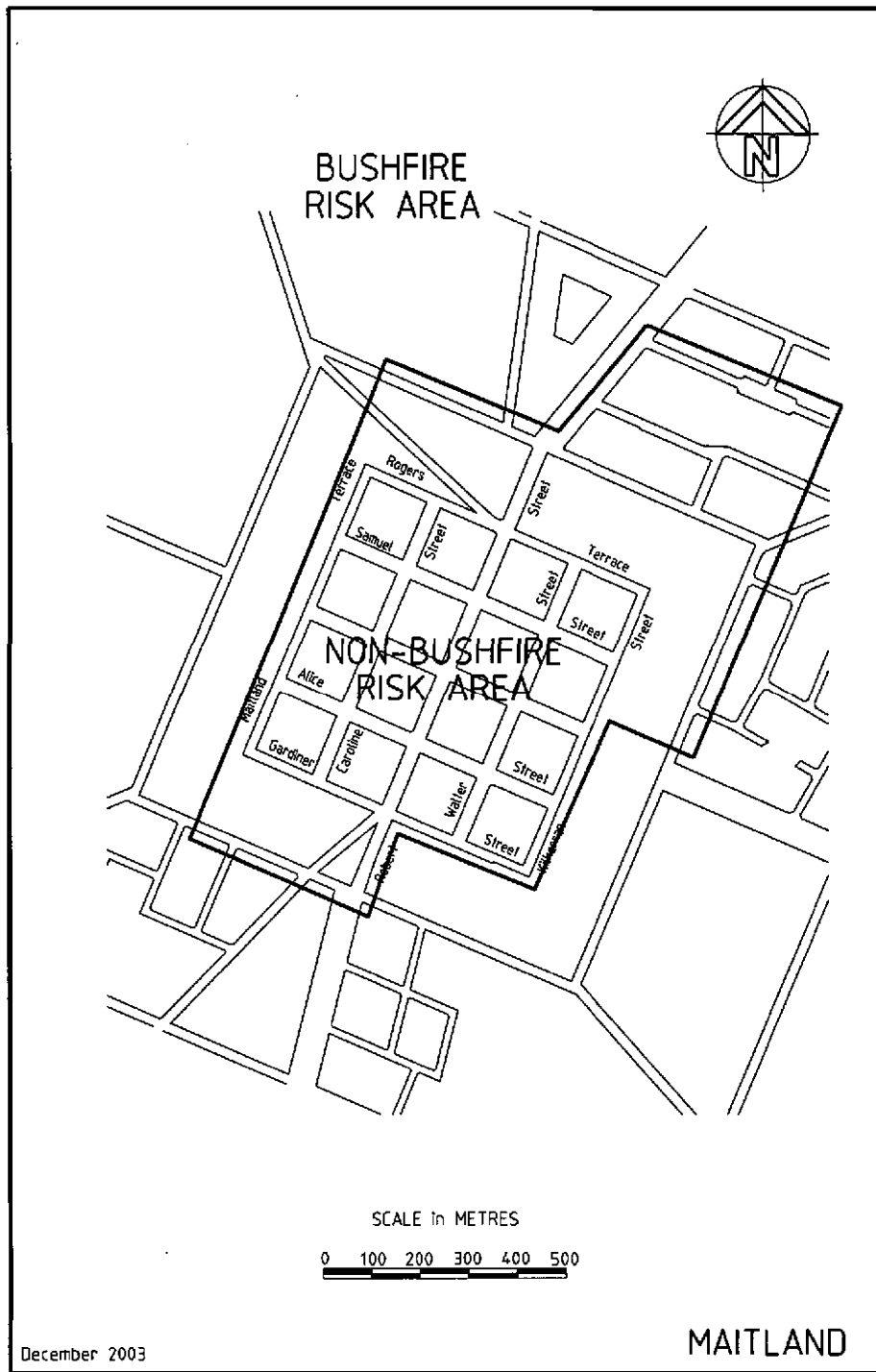

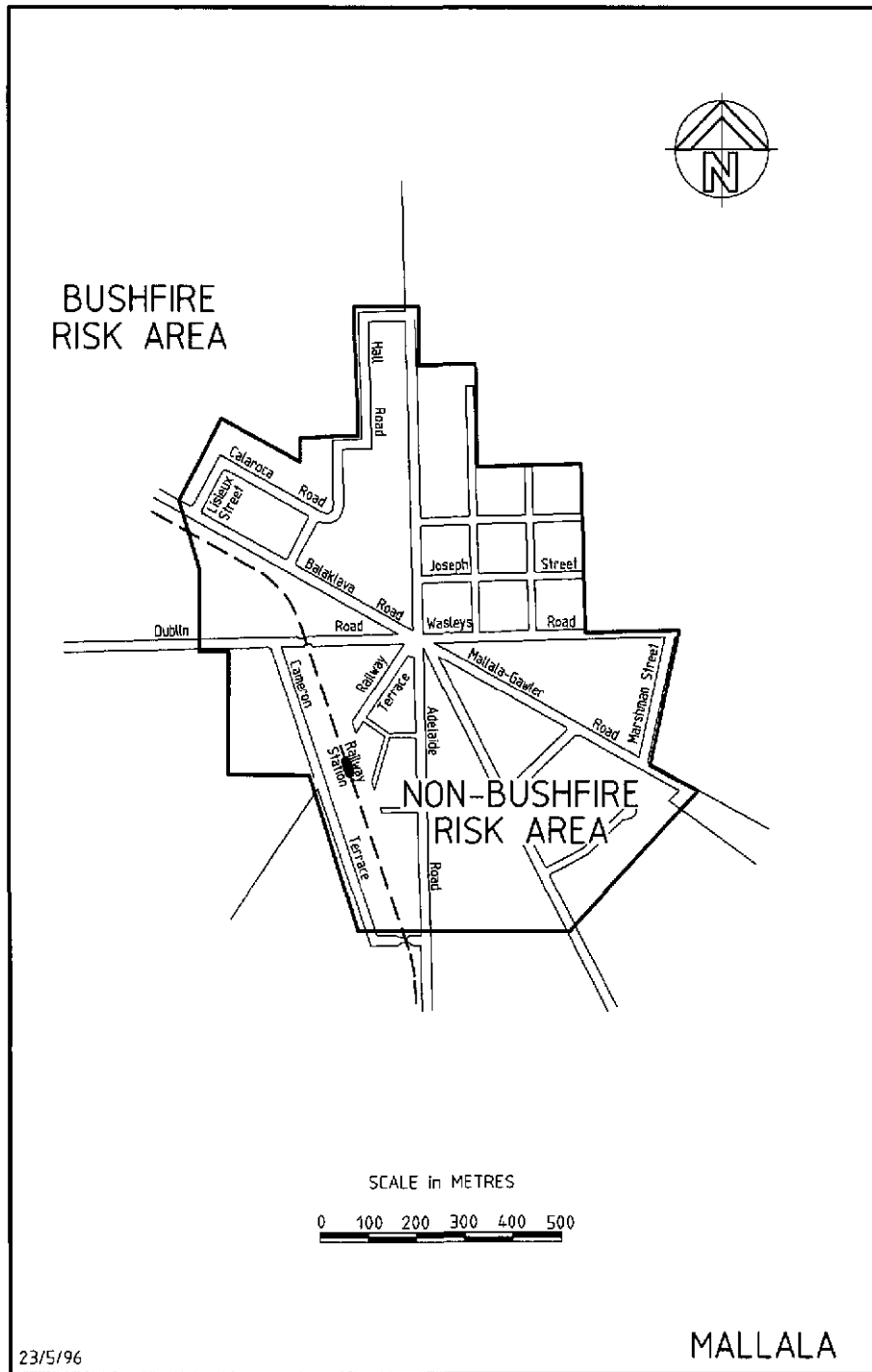

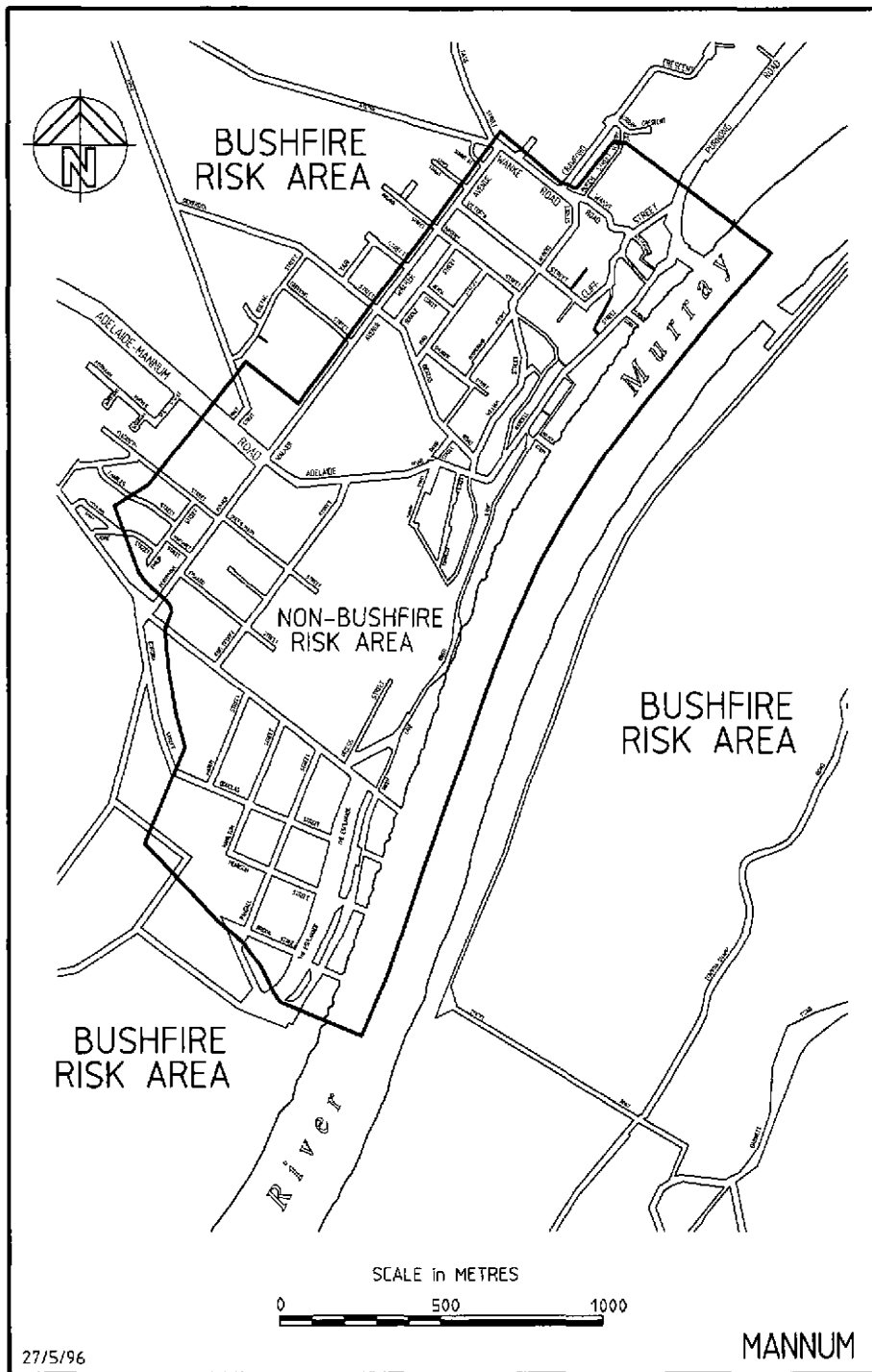

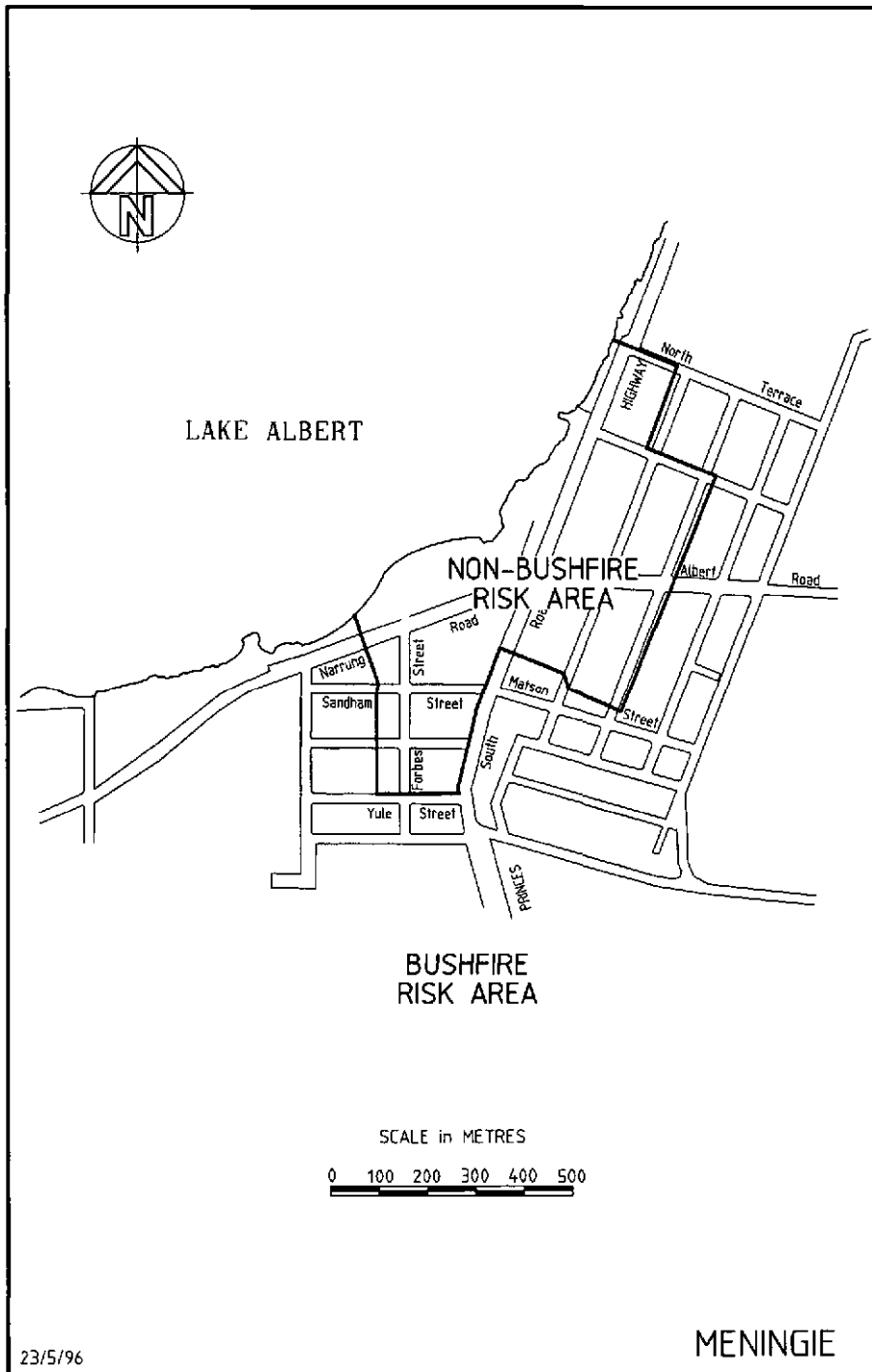

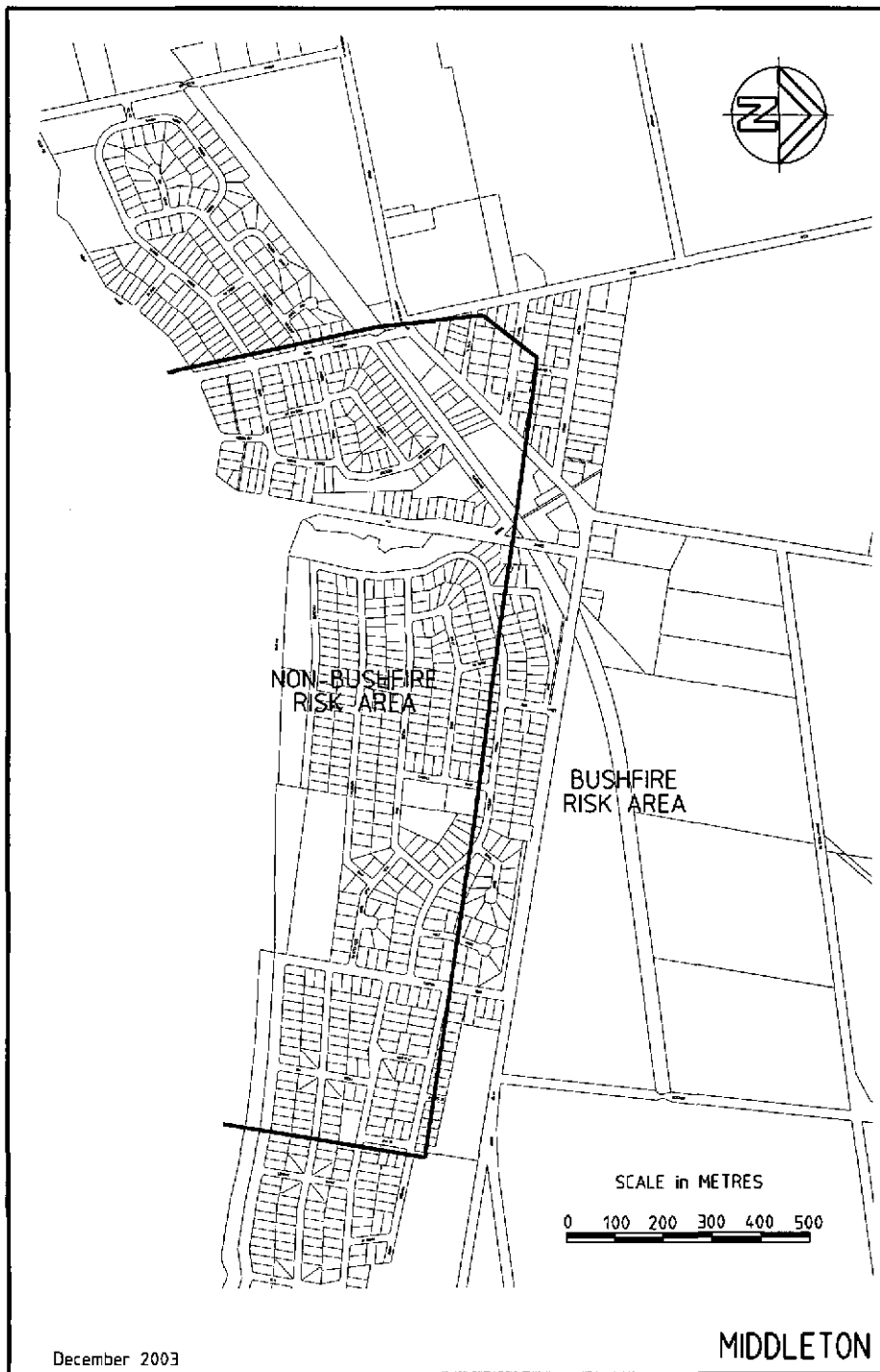

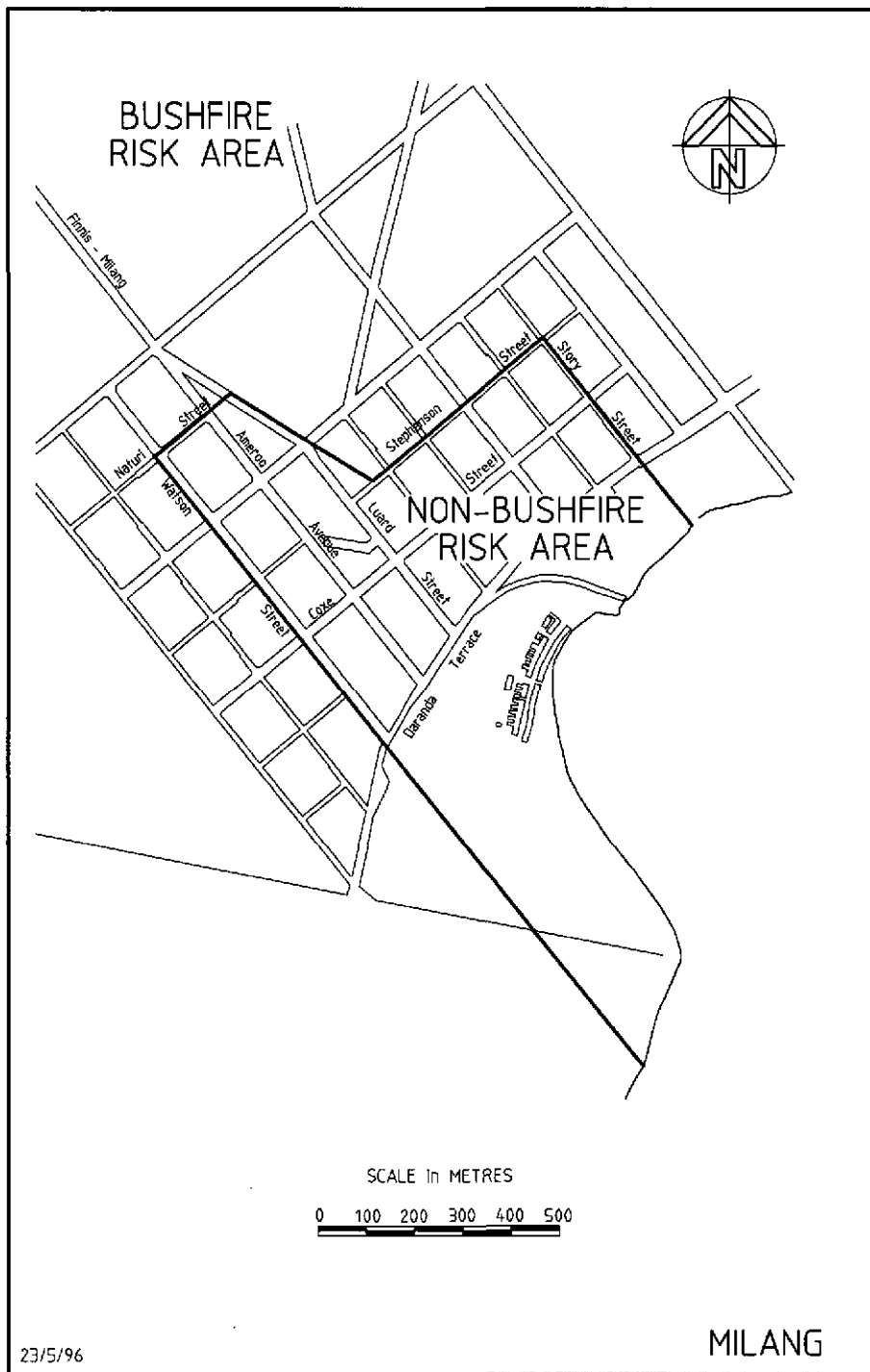

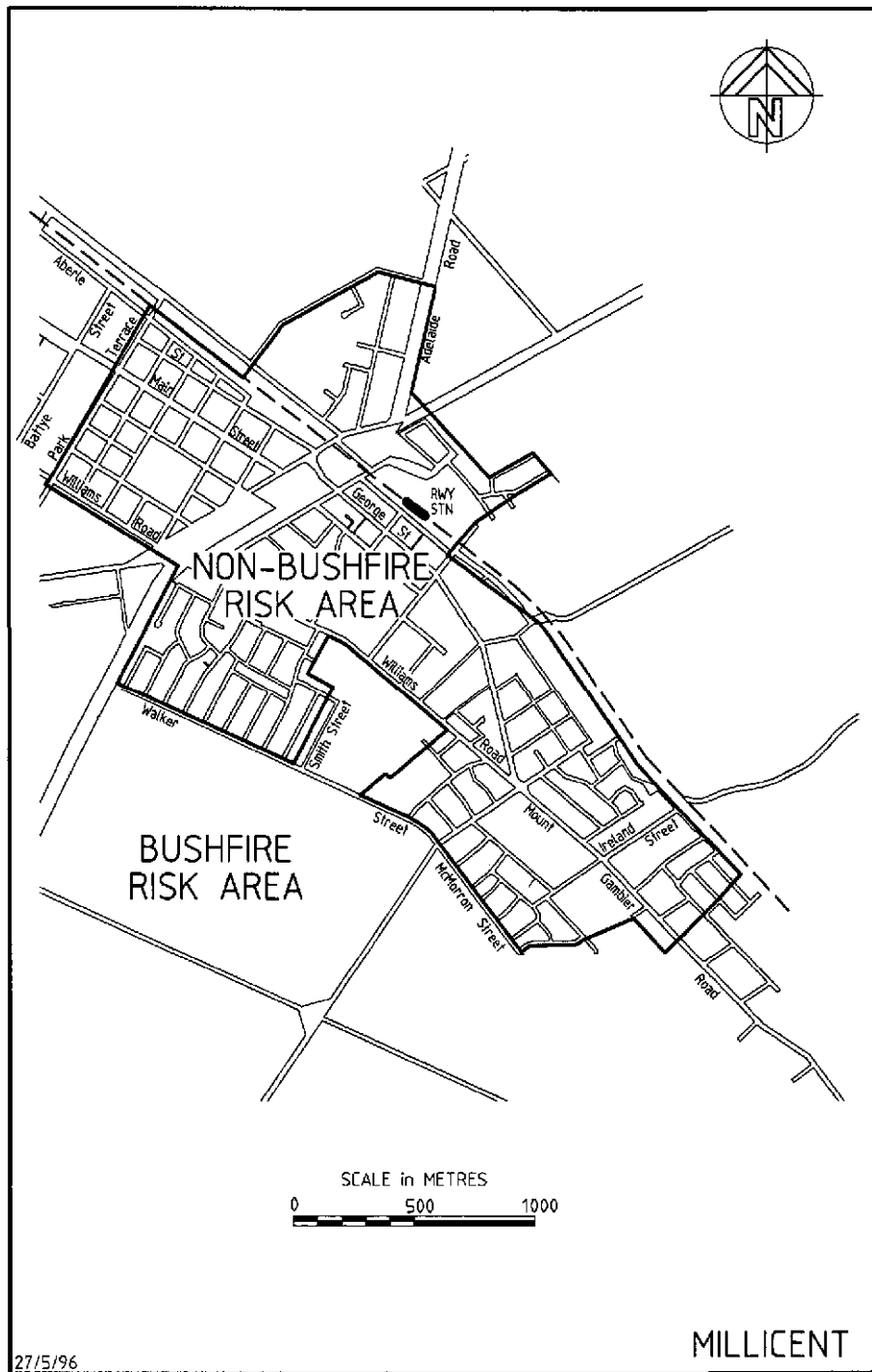

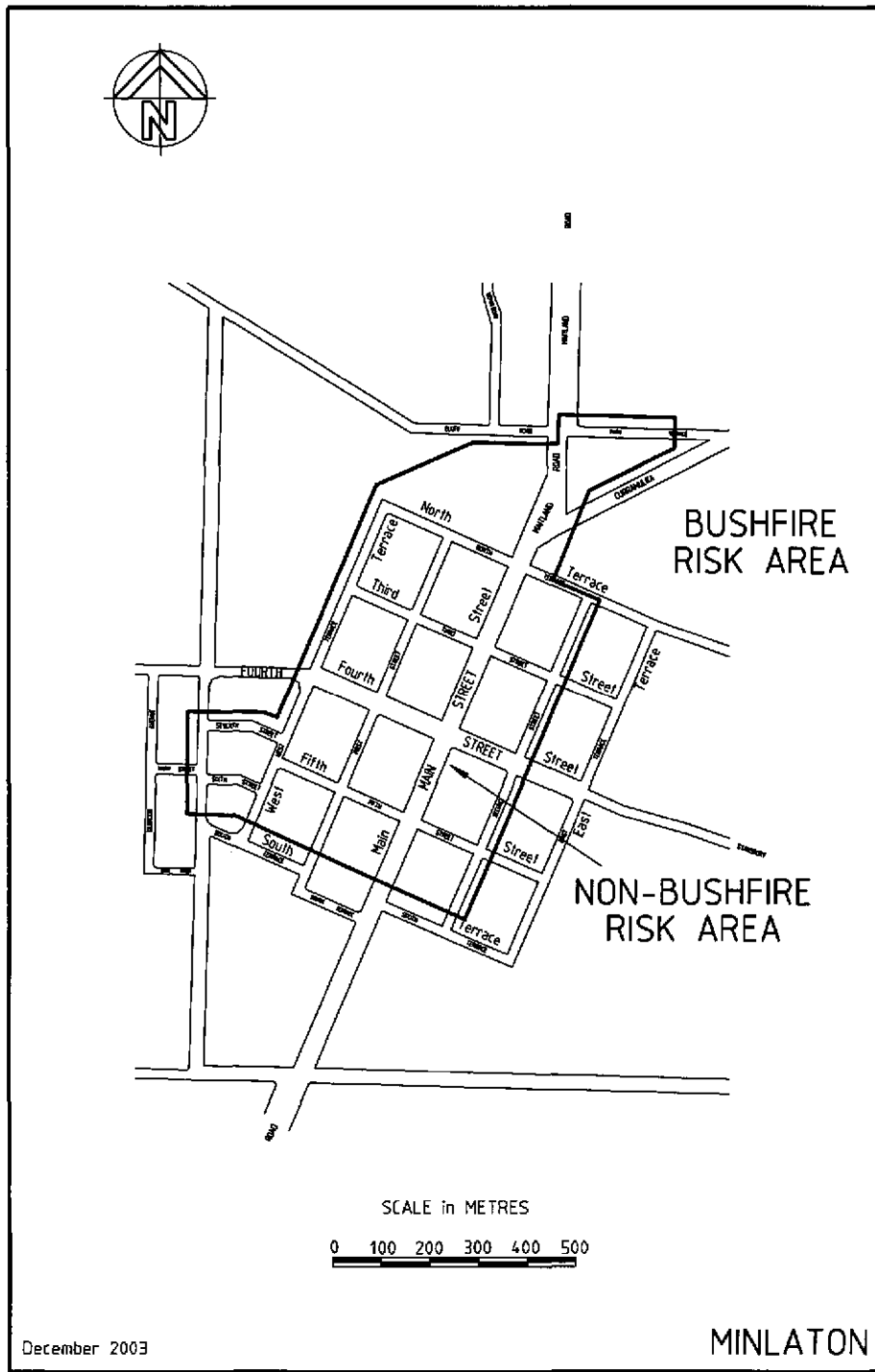

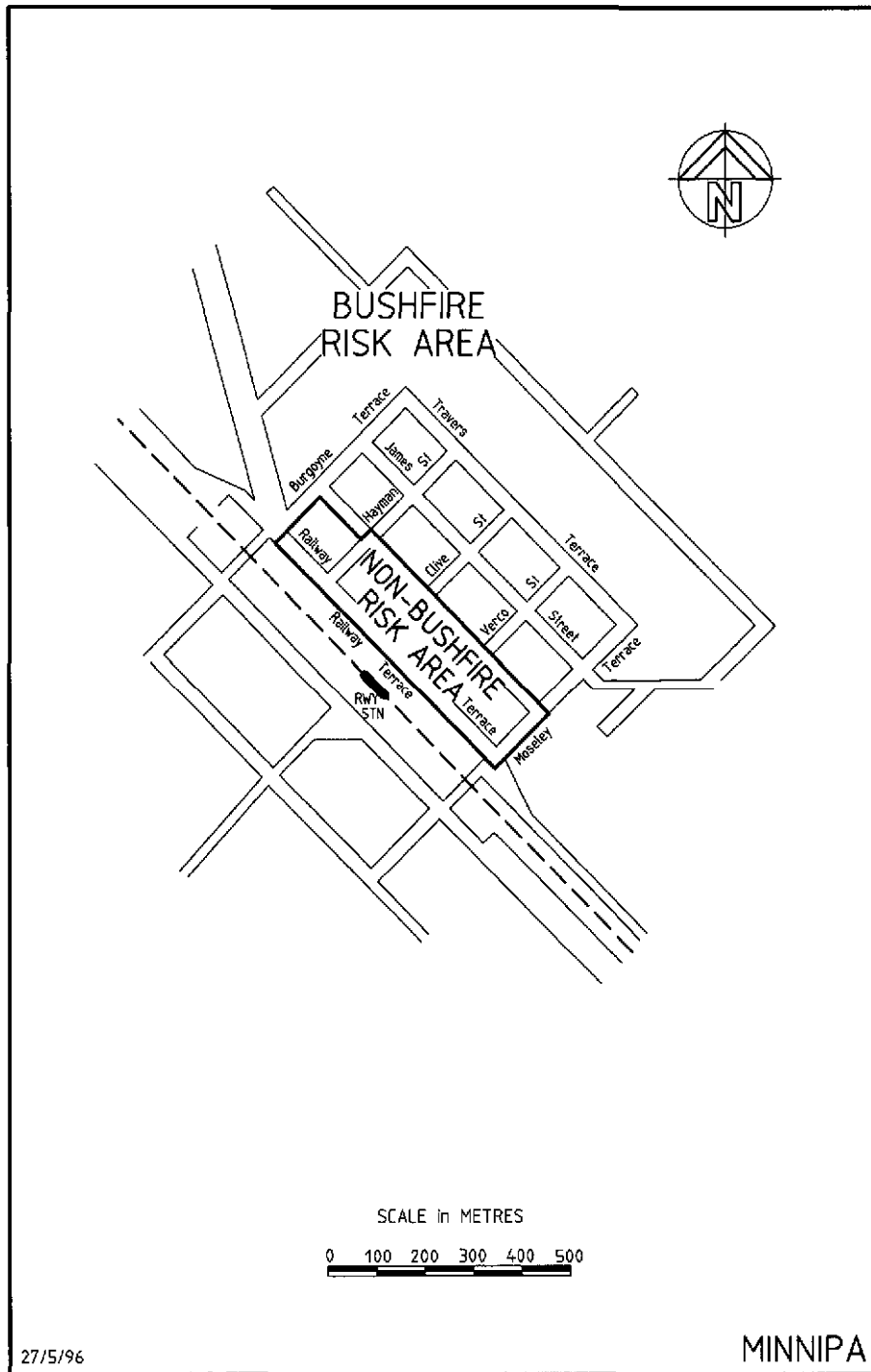

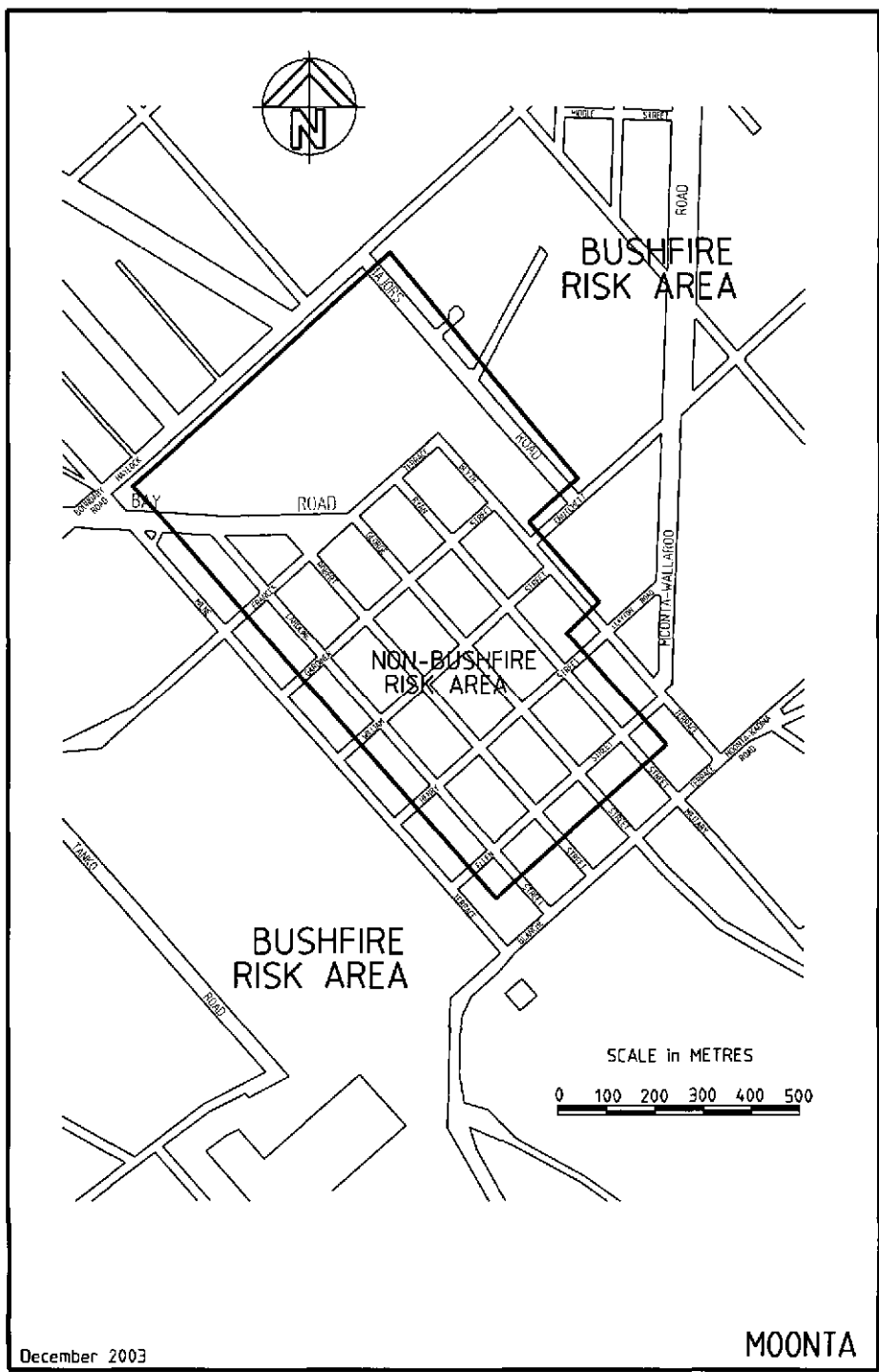

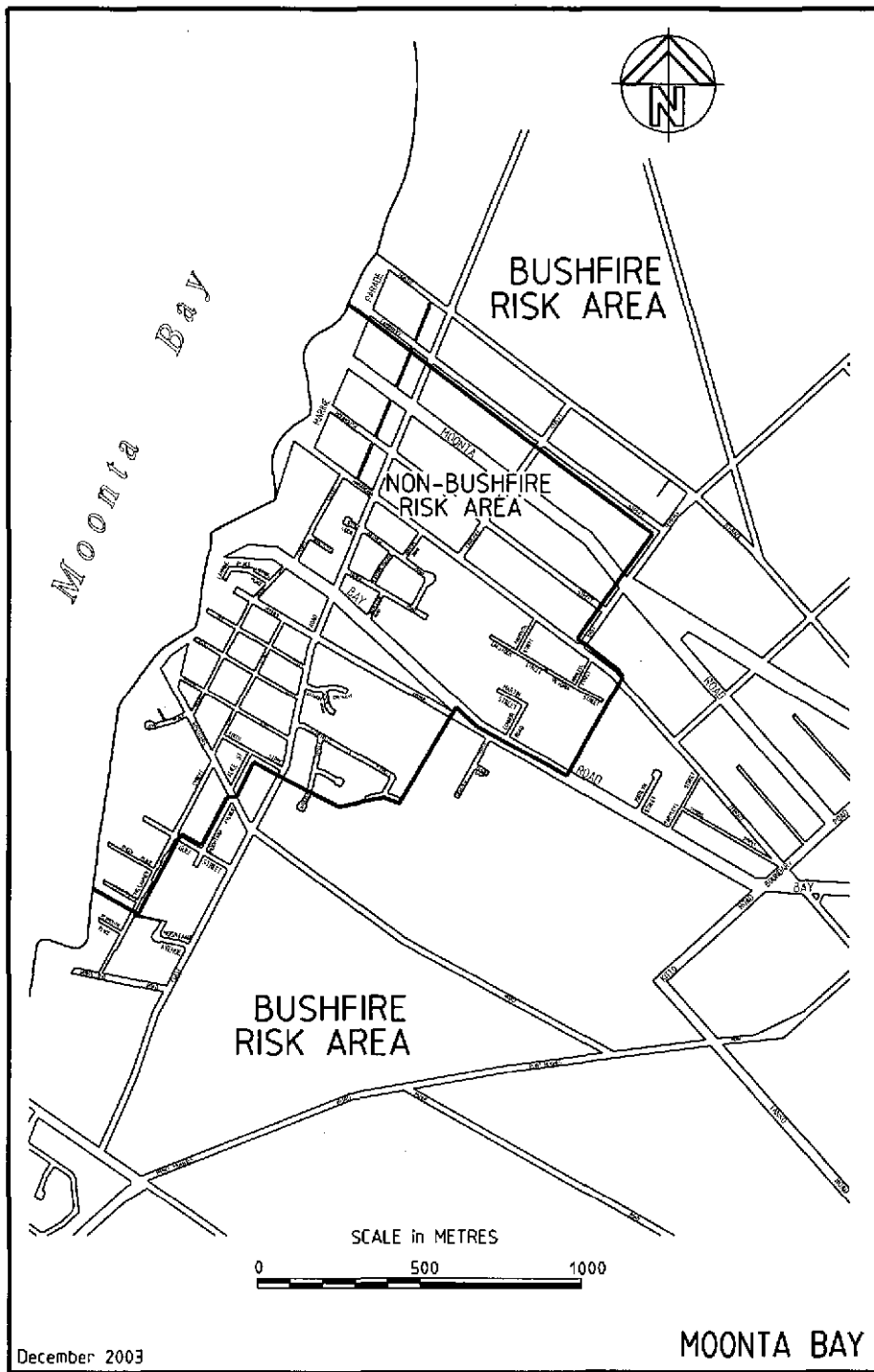

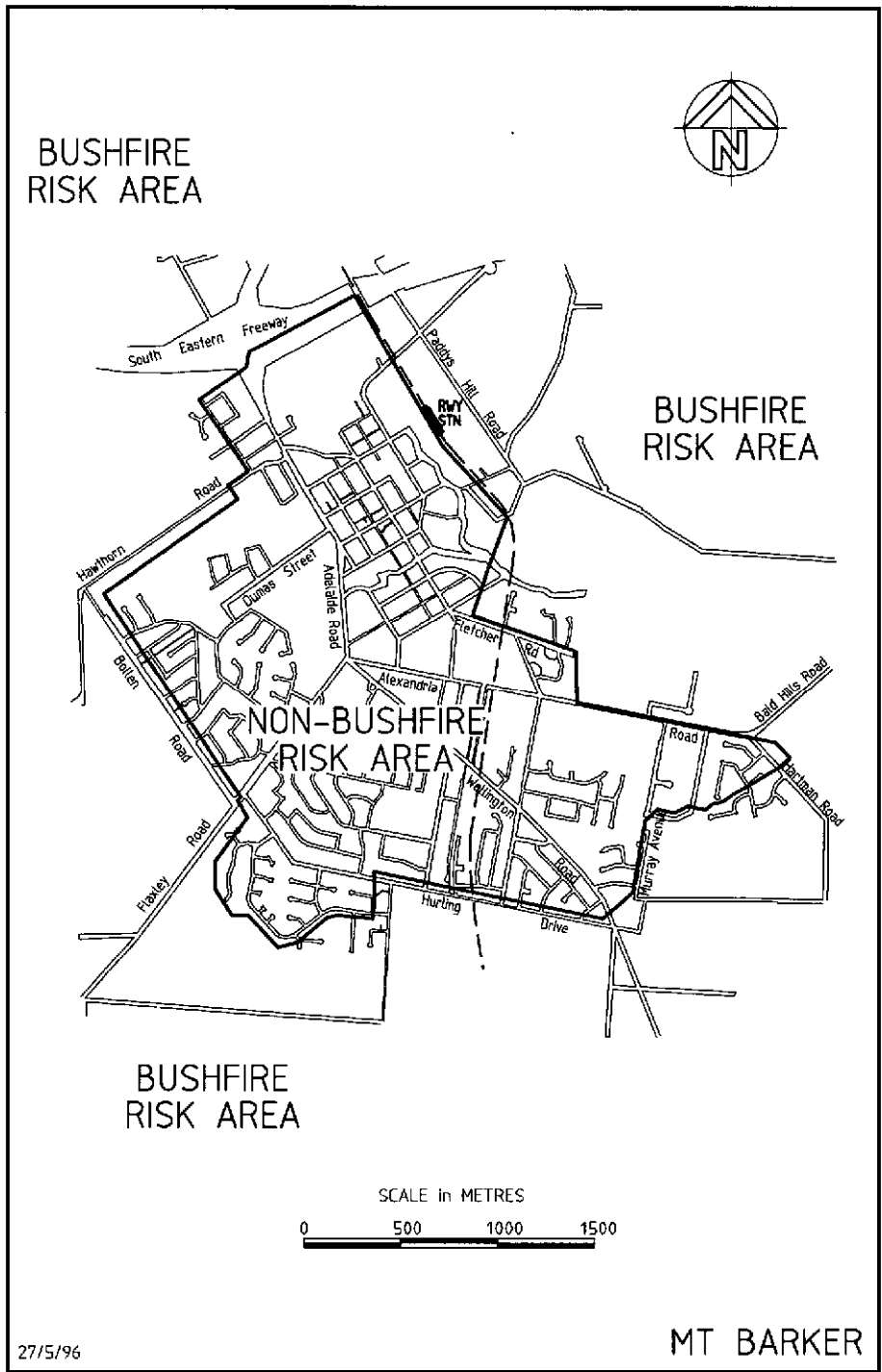

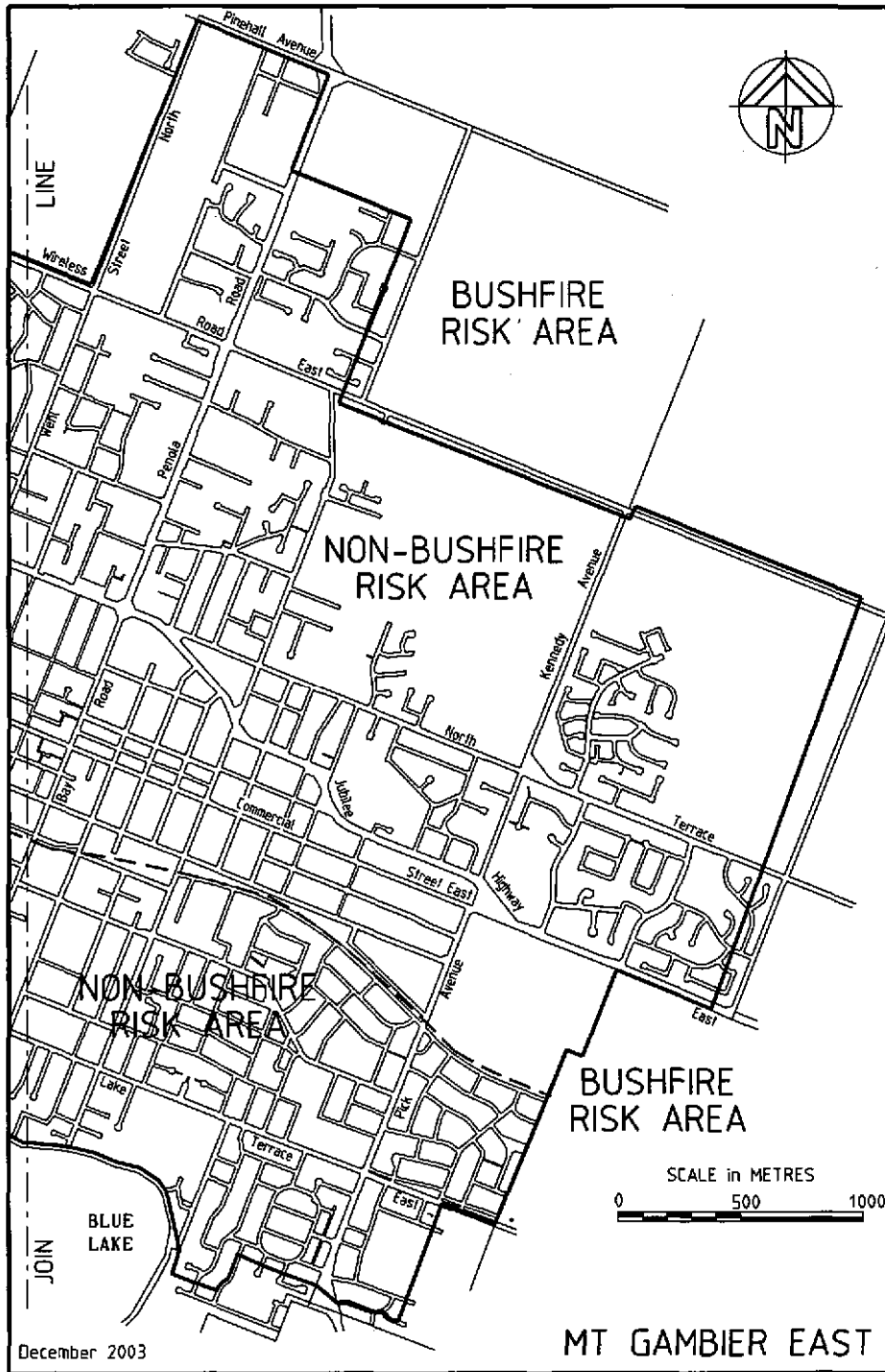

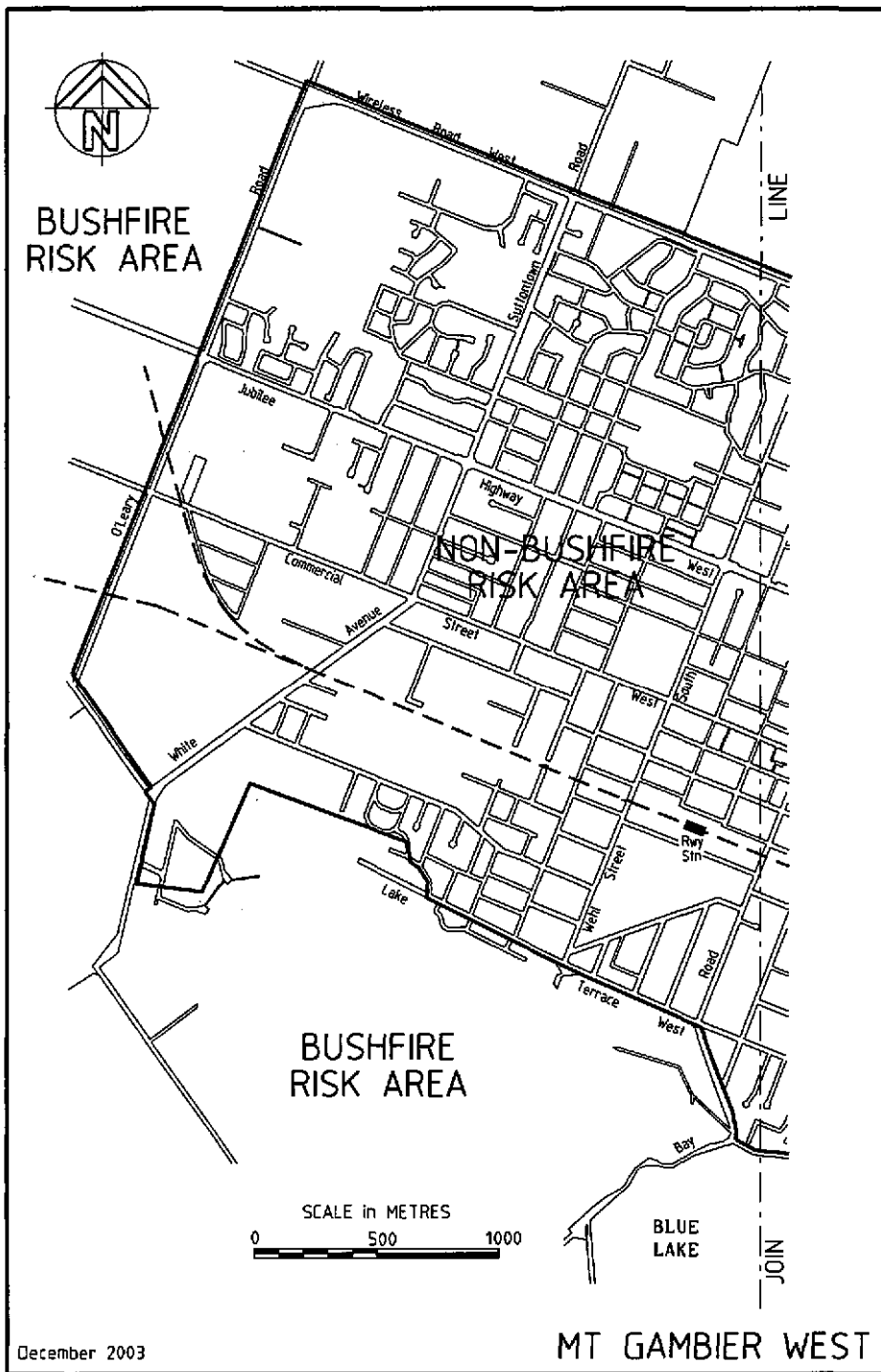

December 2003

MT GAMBIER WEST

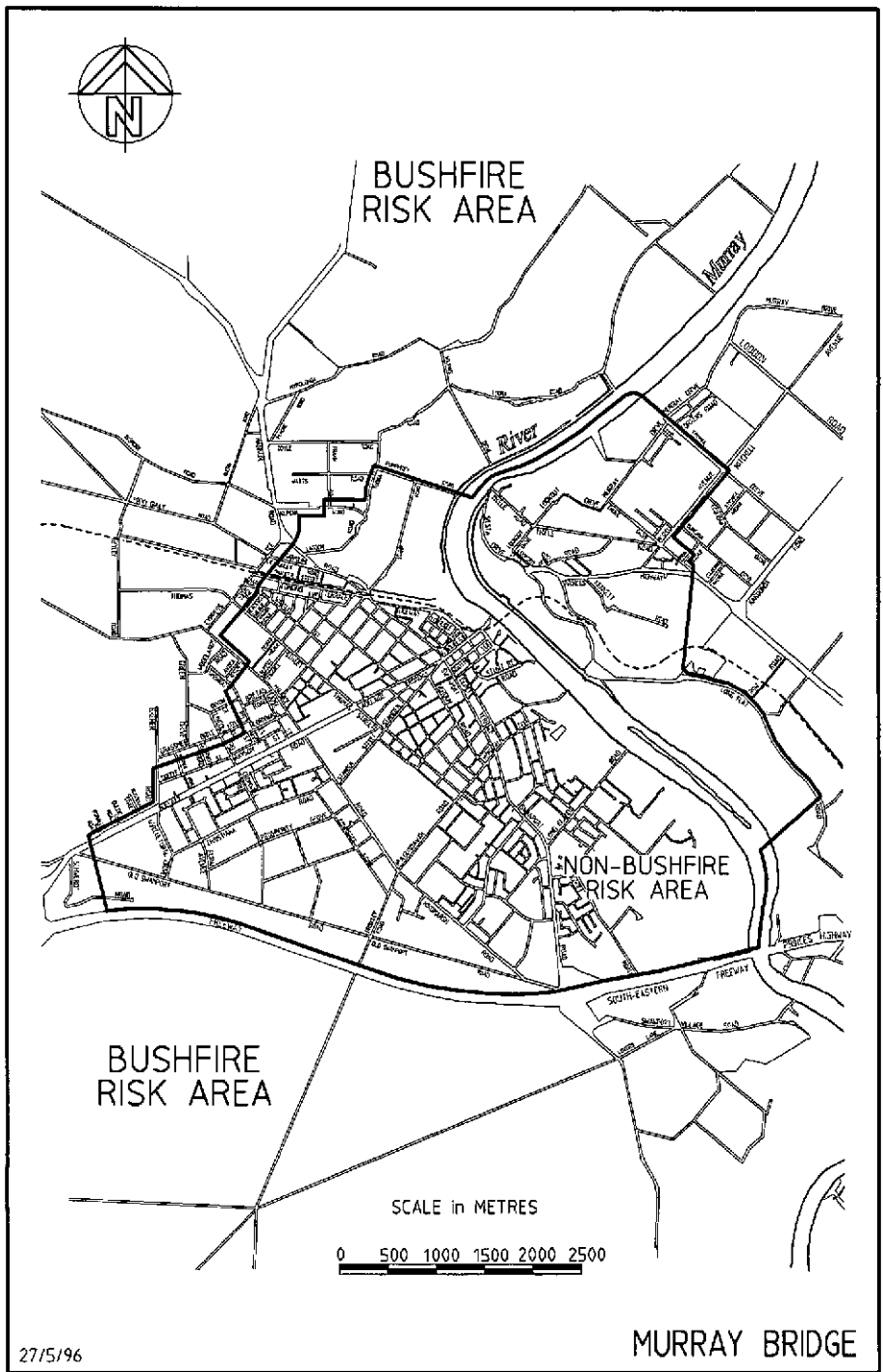

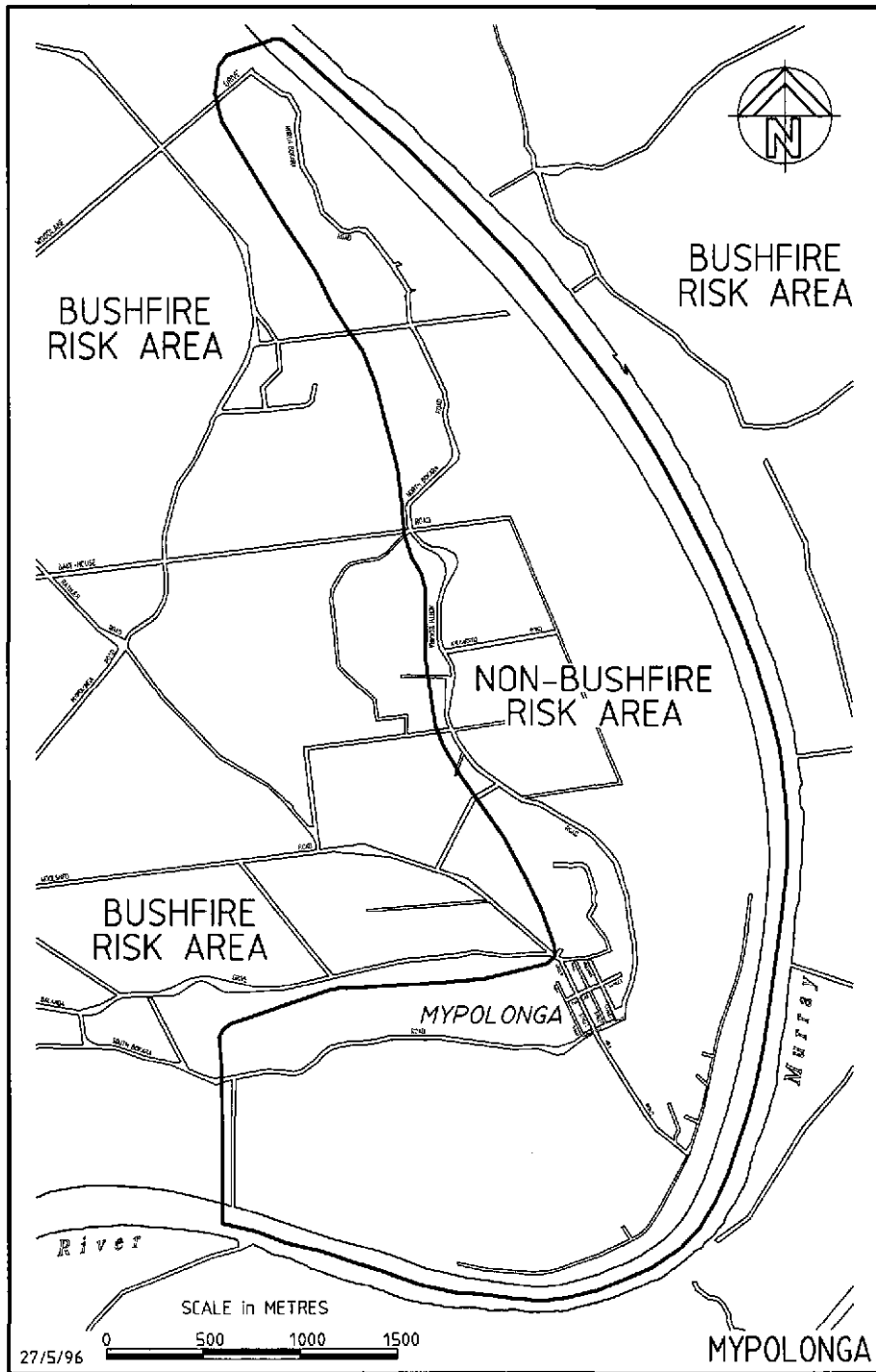

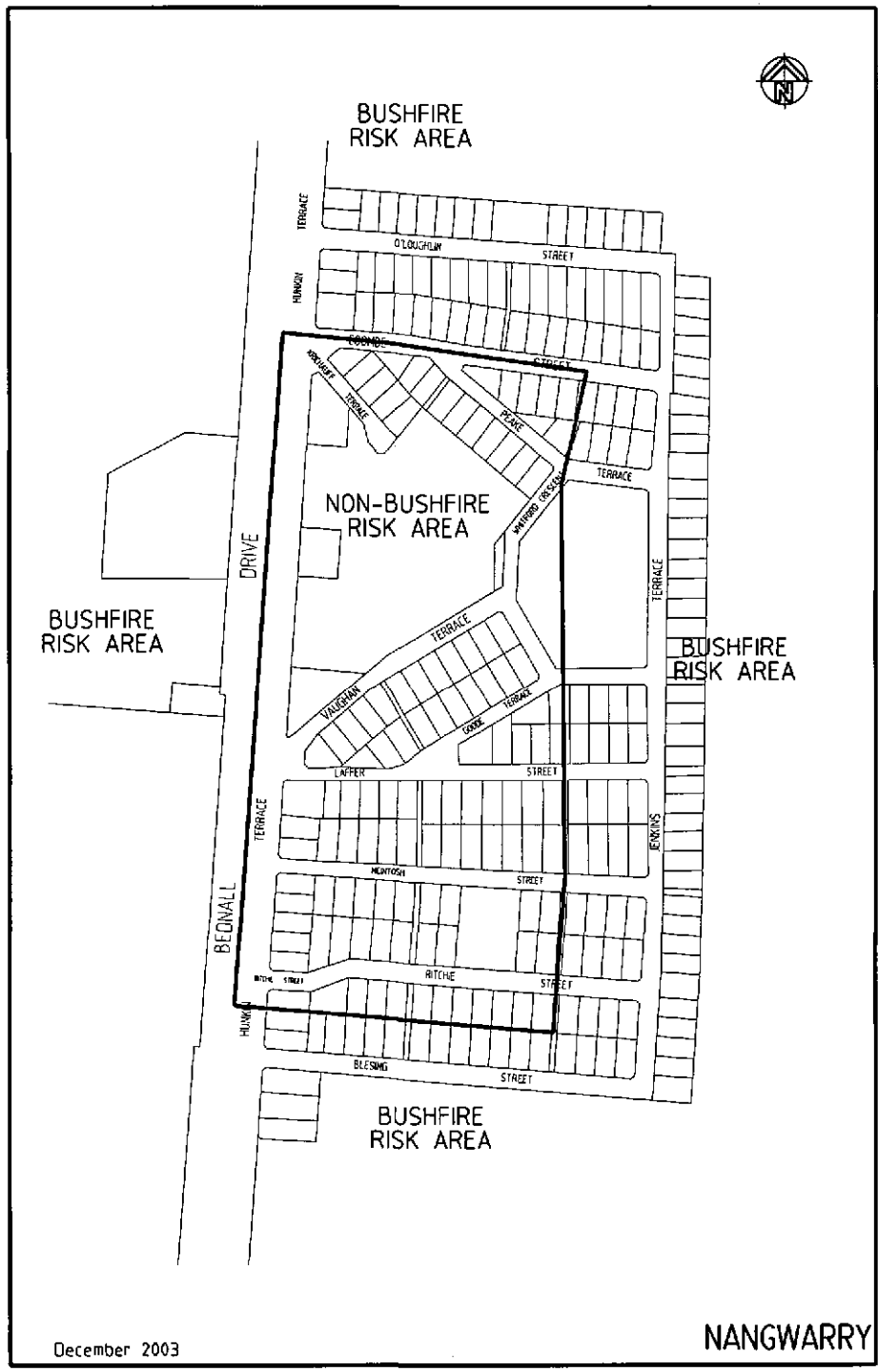

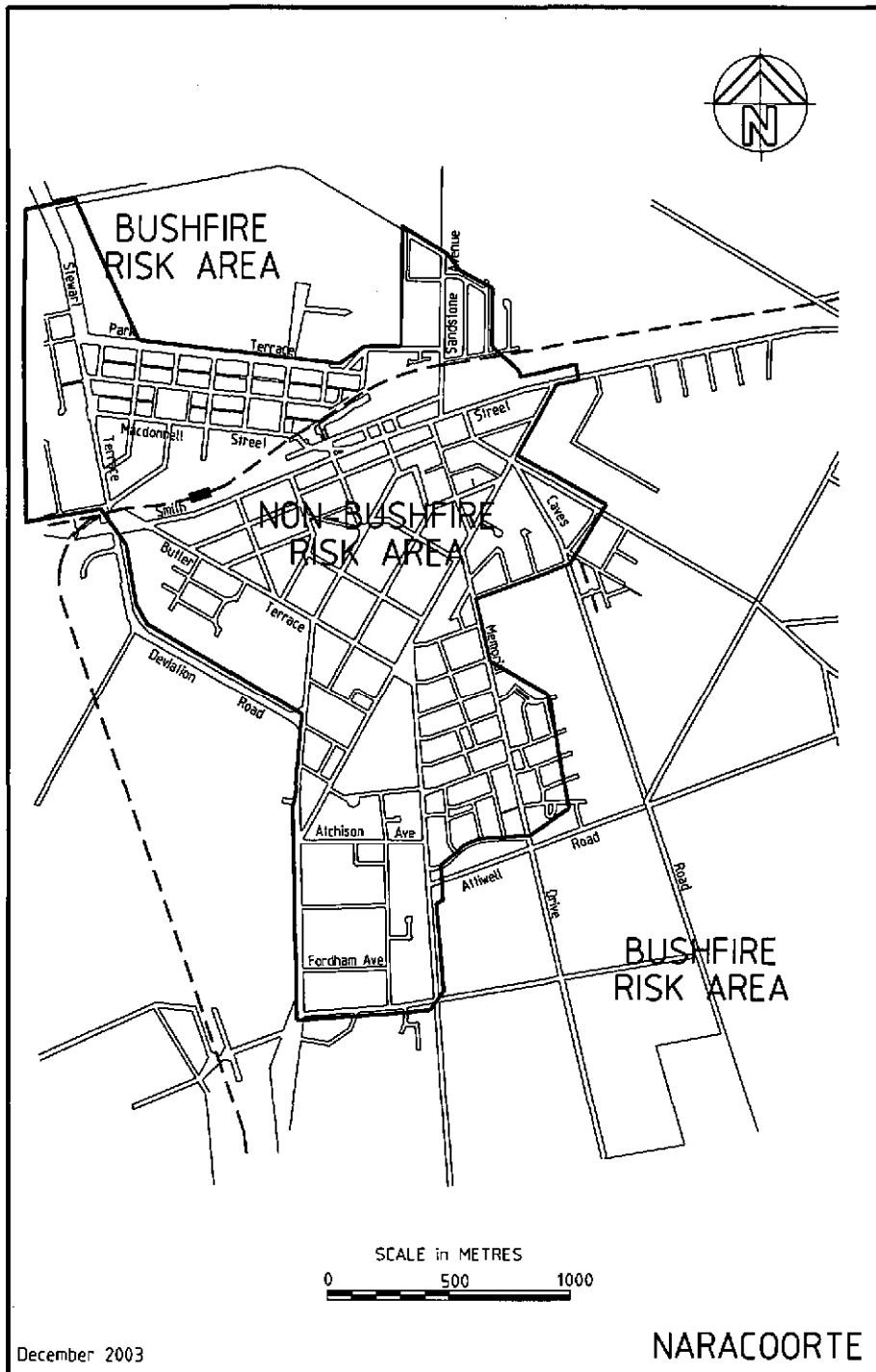

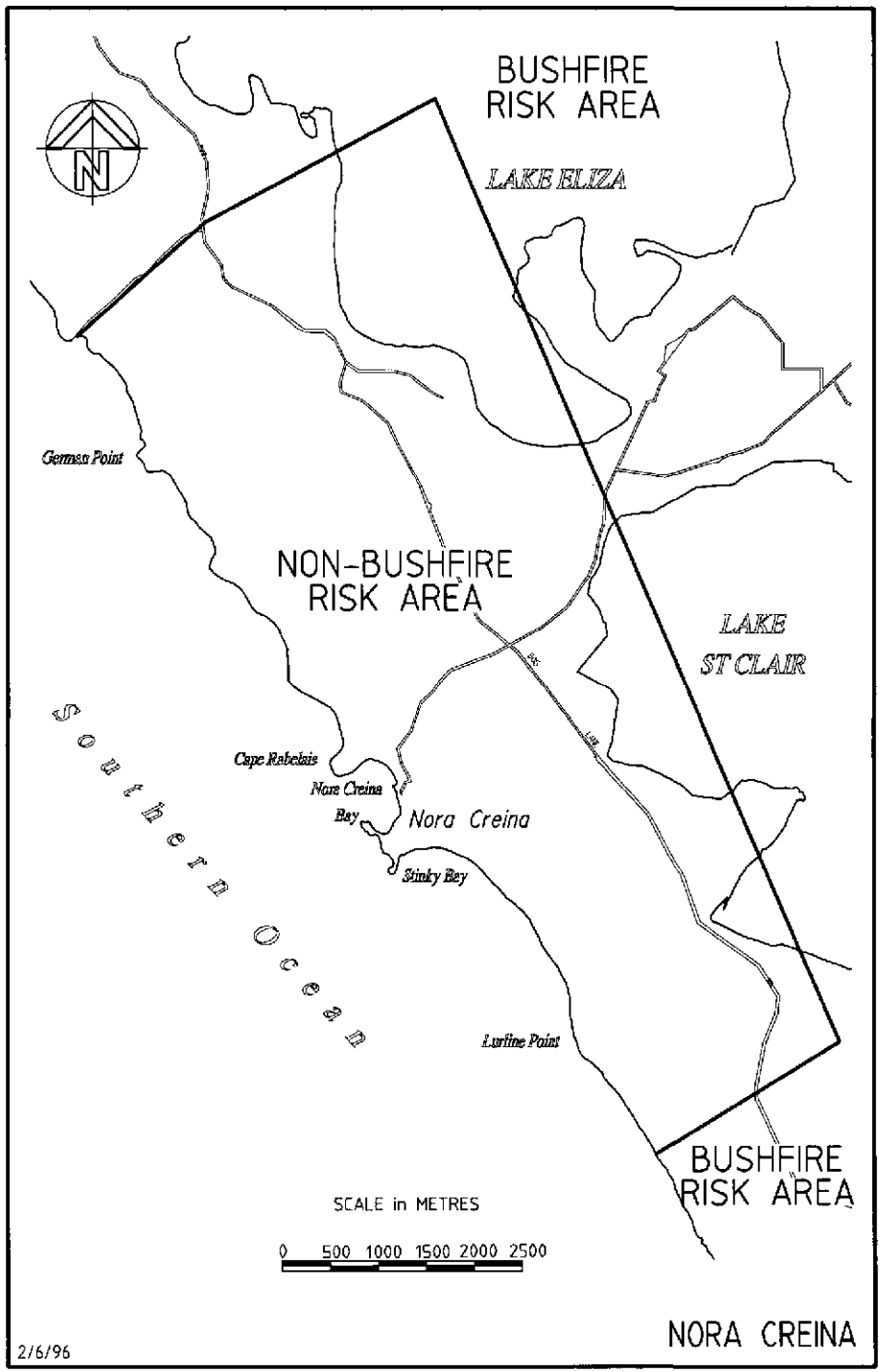

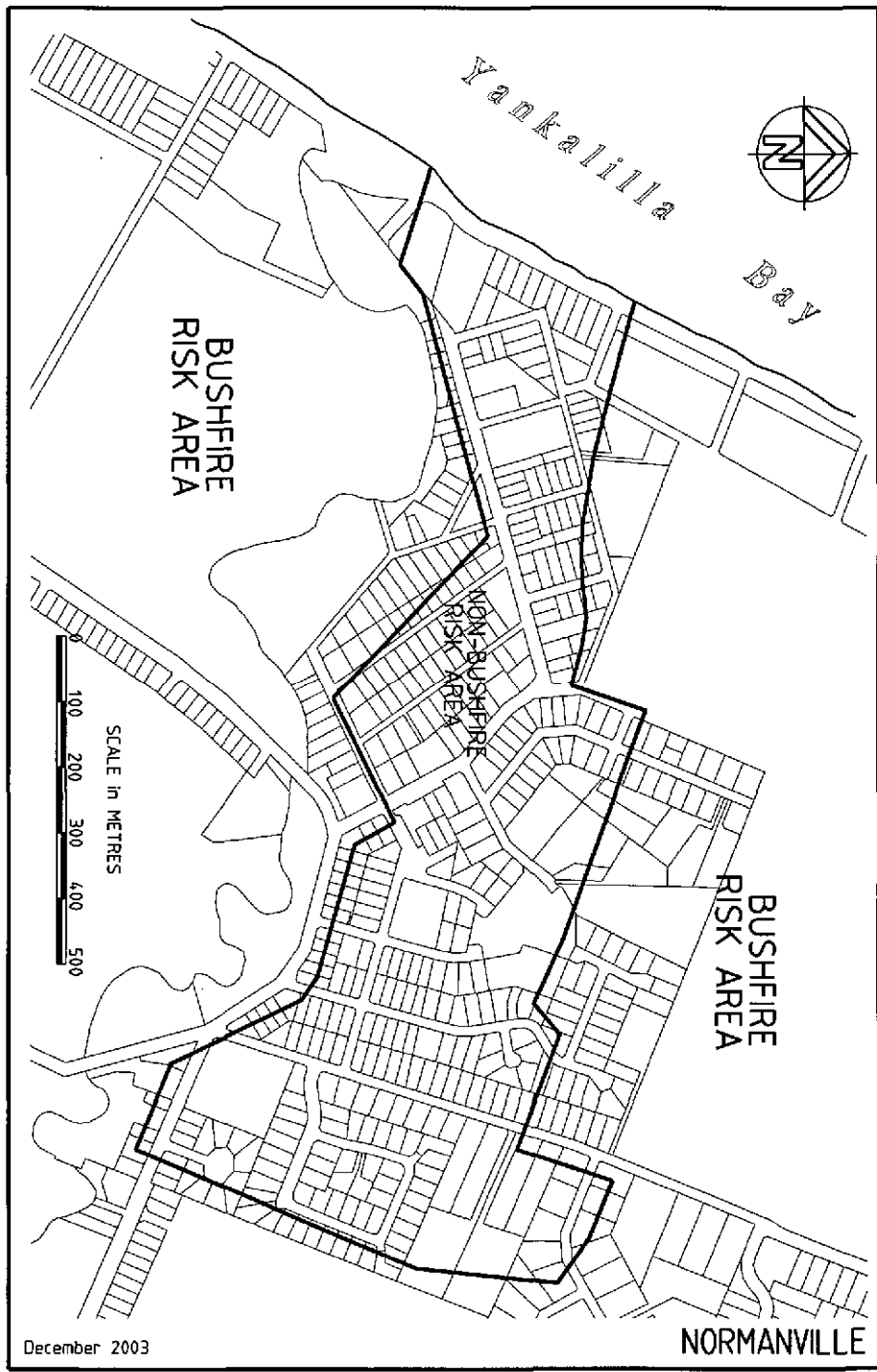

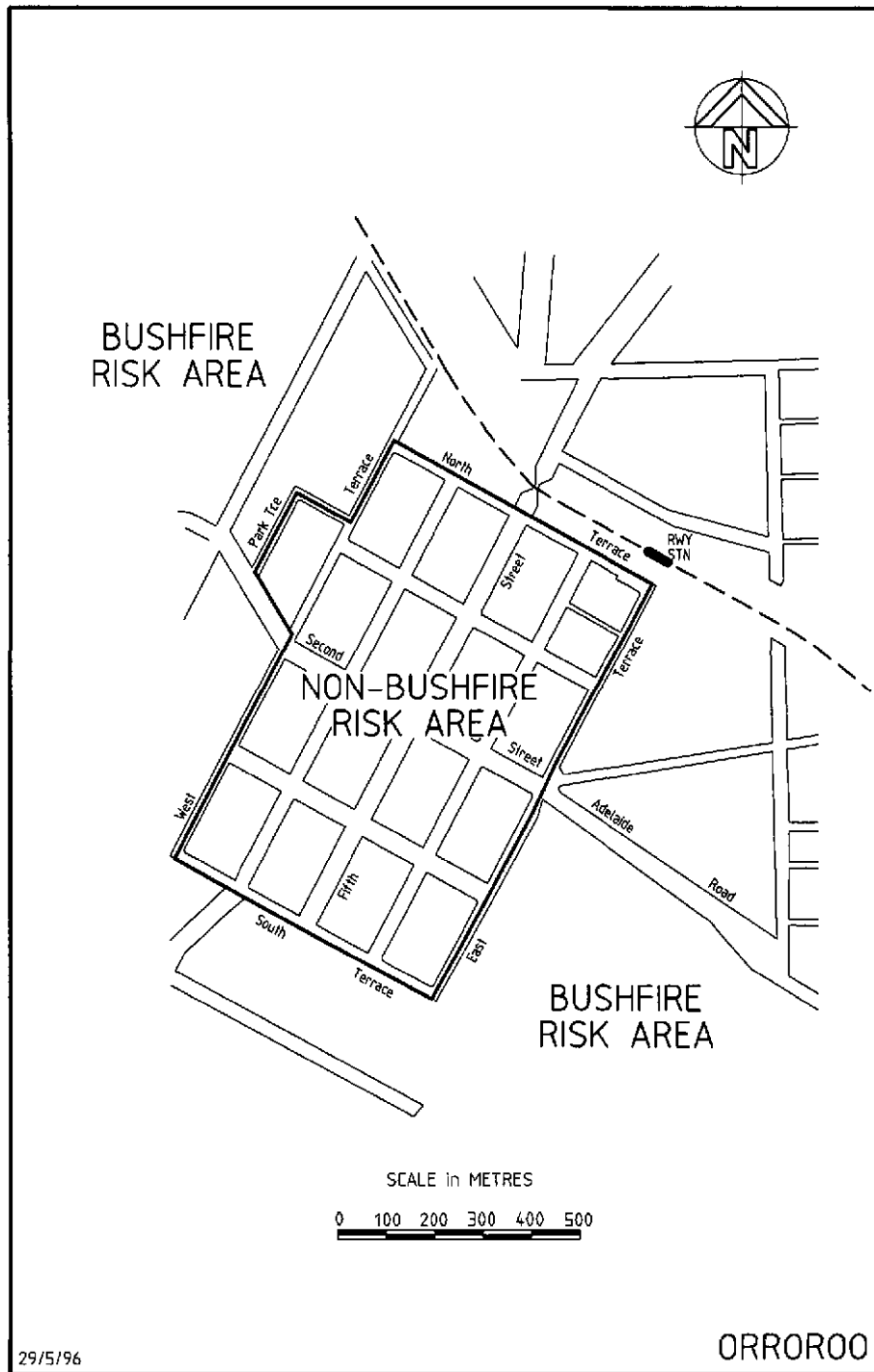

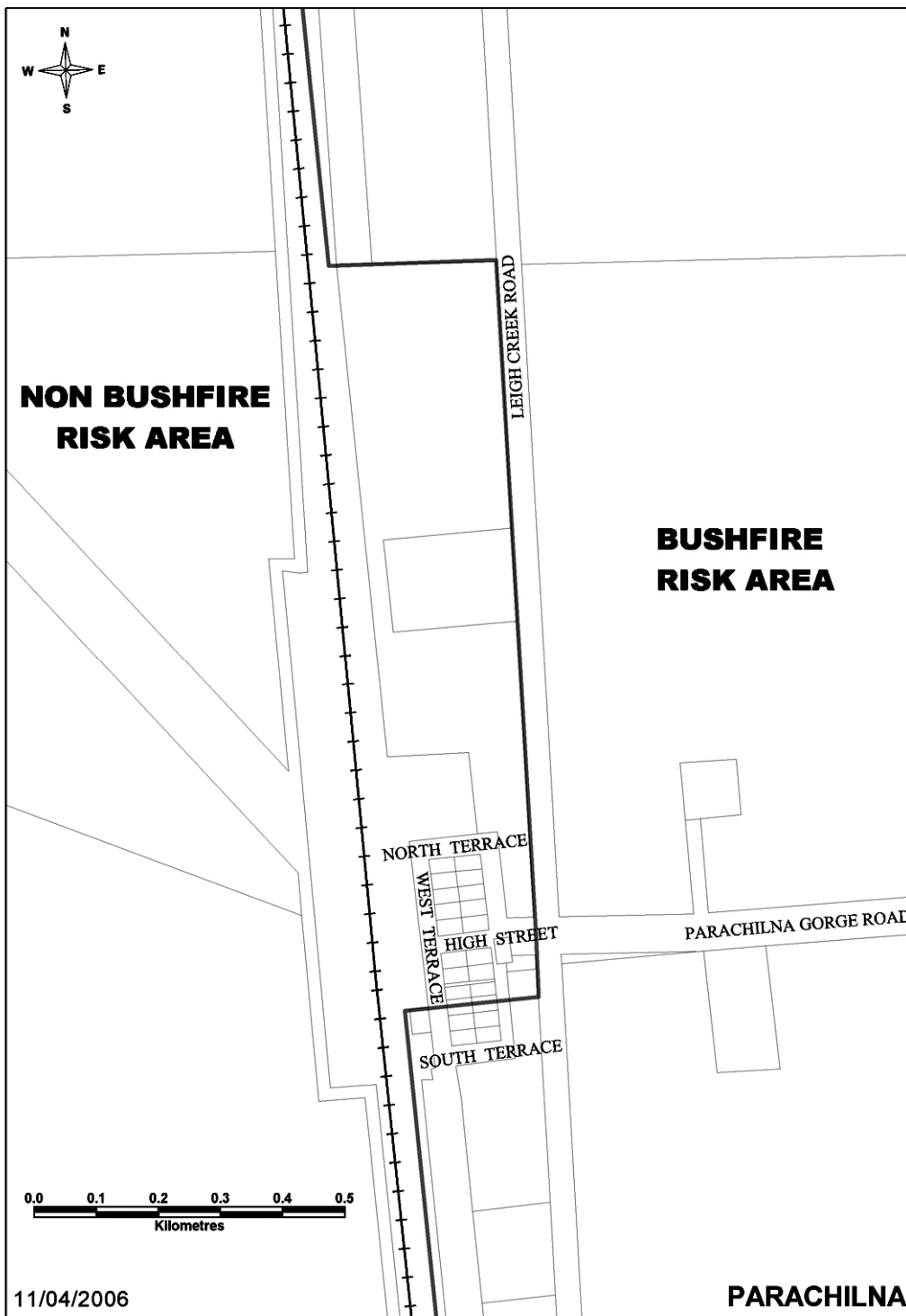

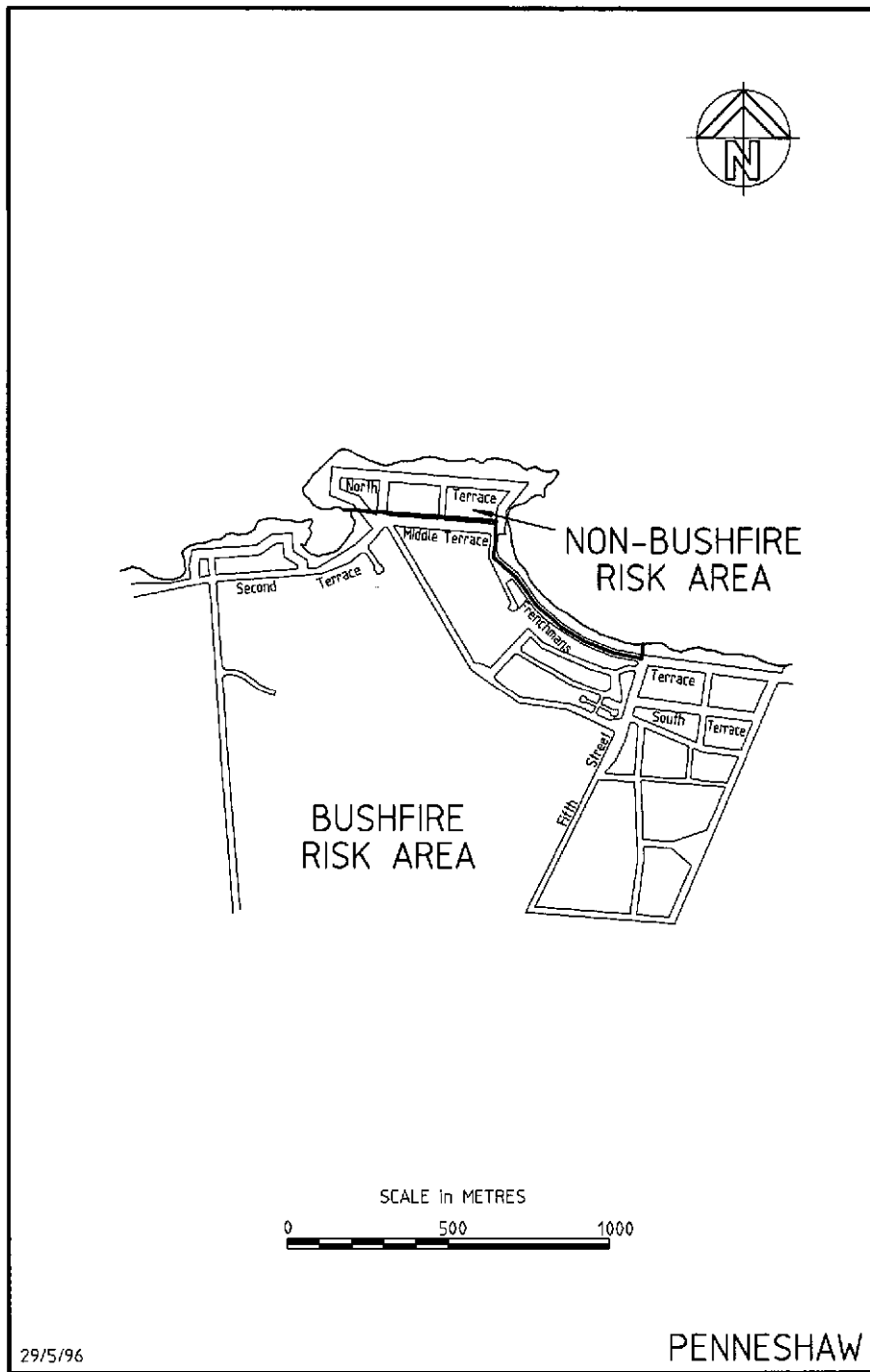

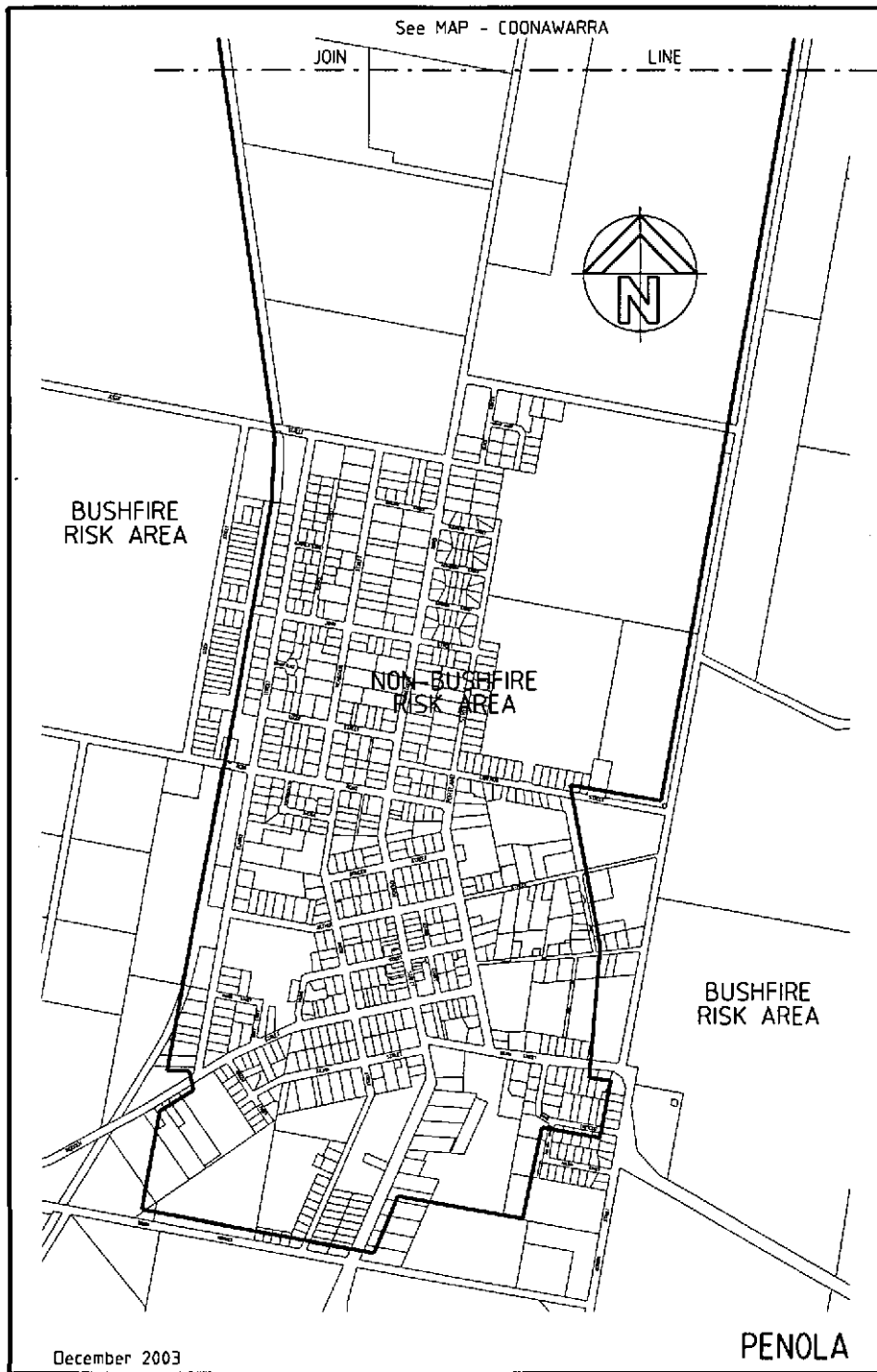

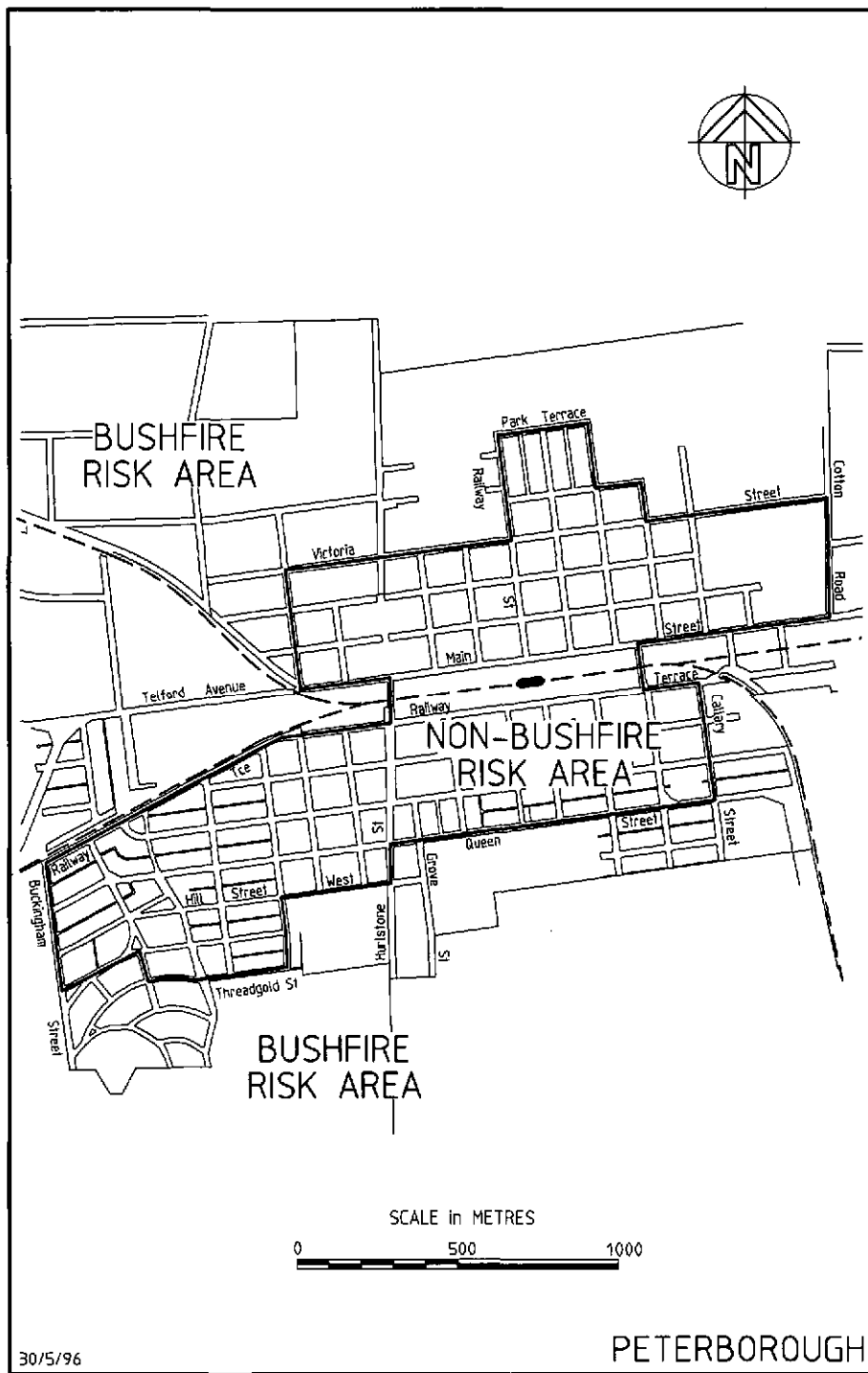

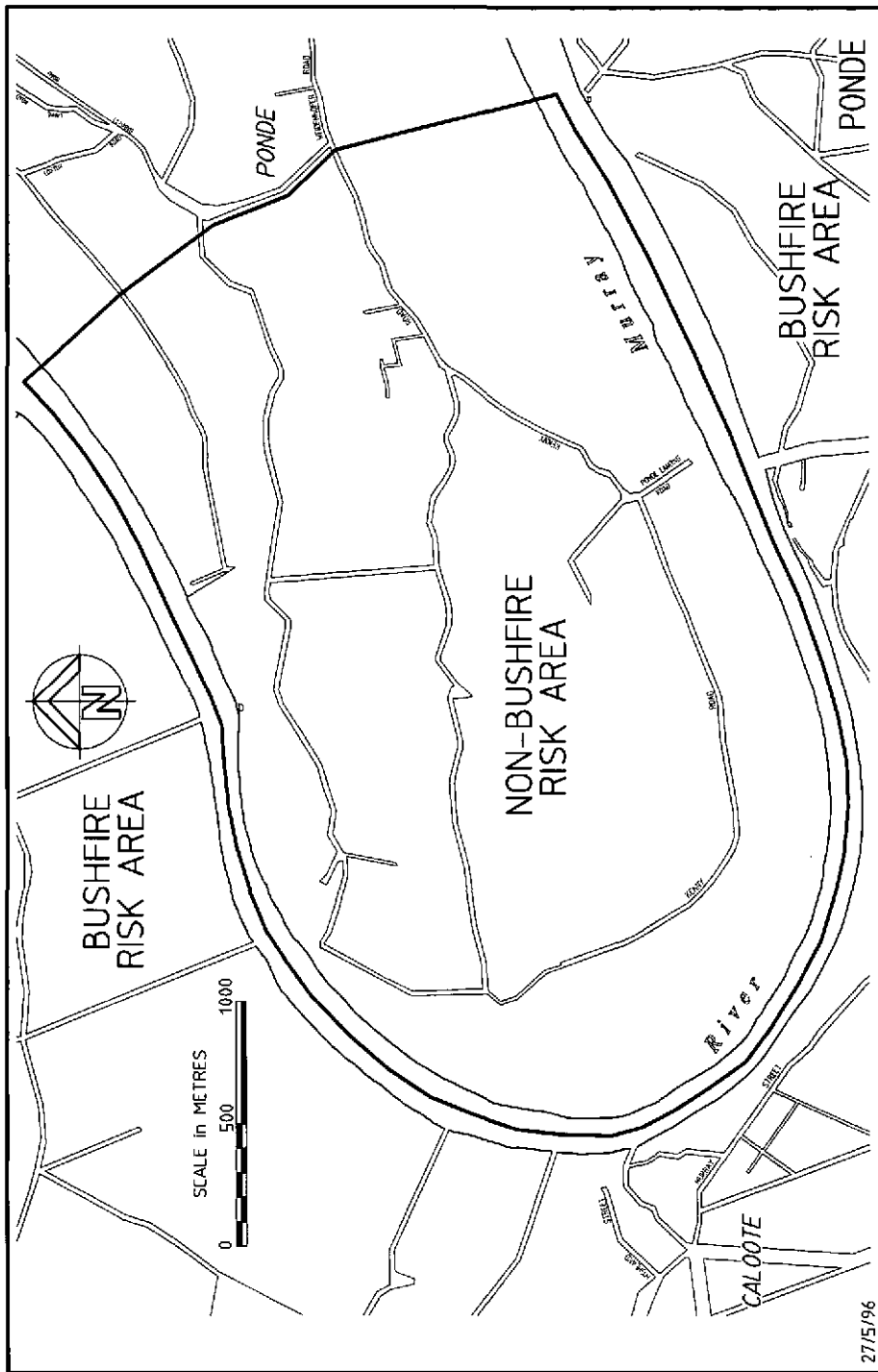

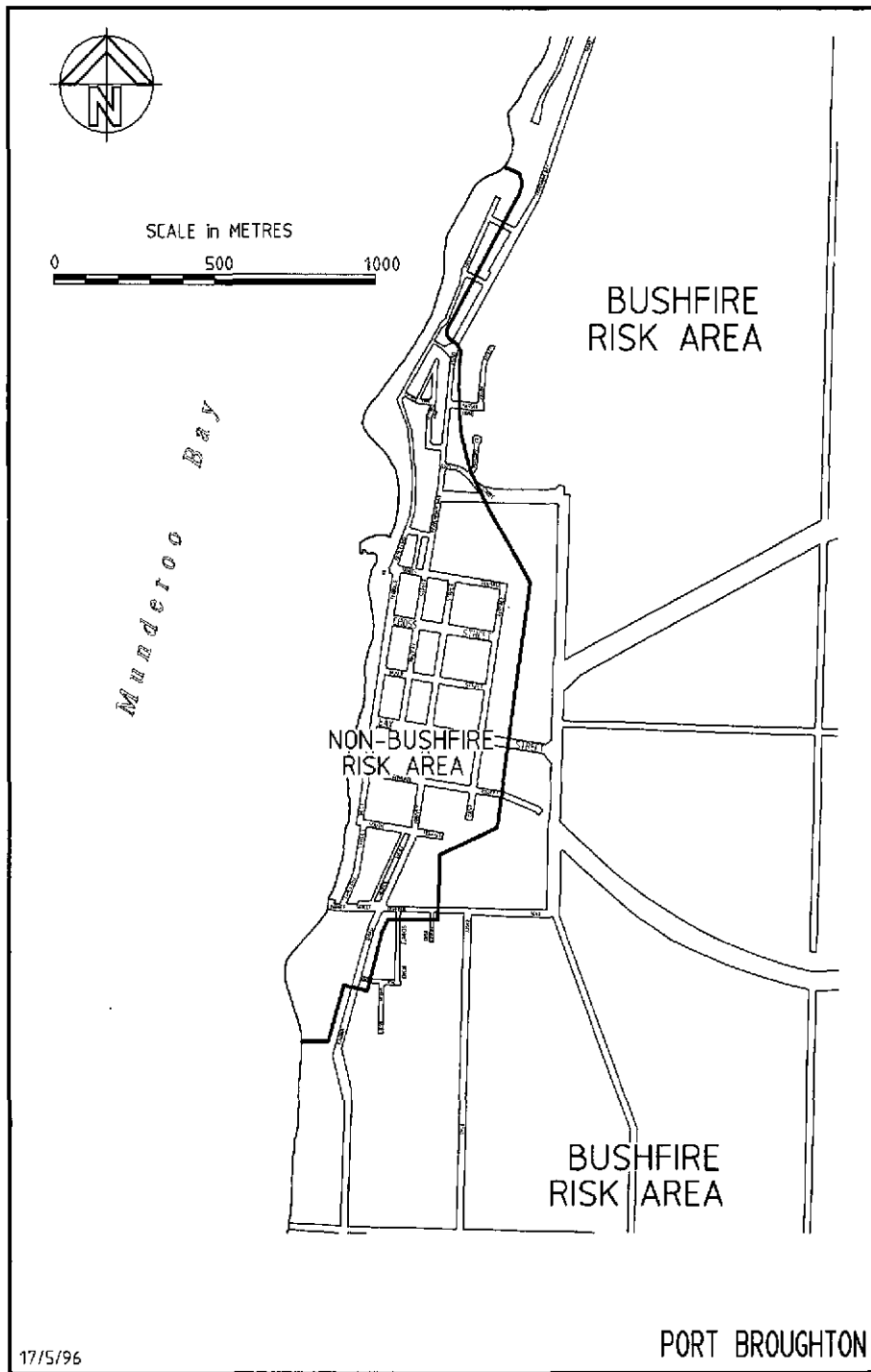

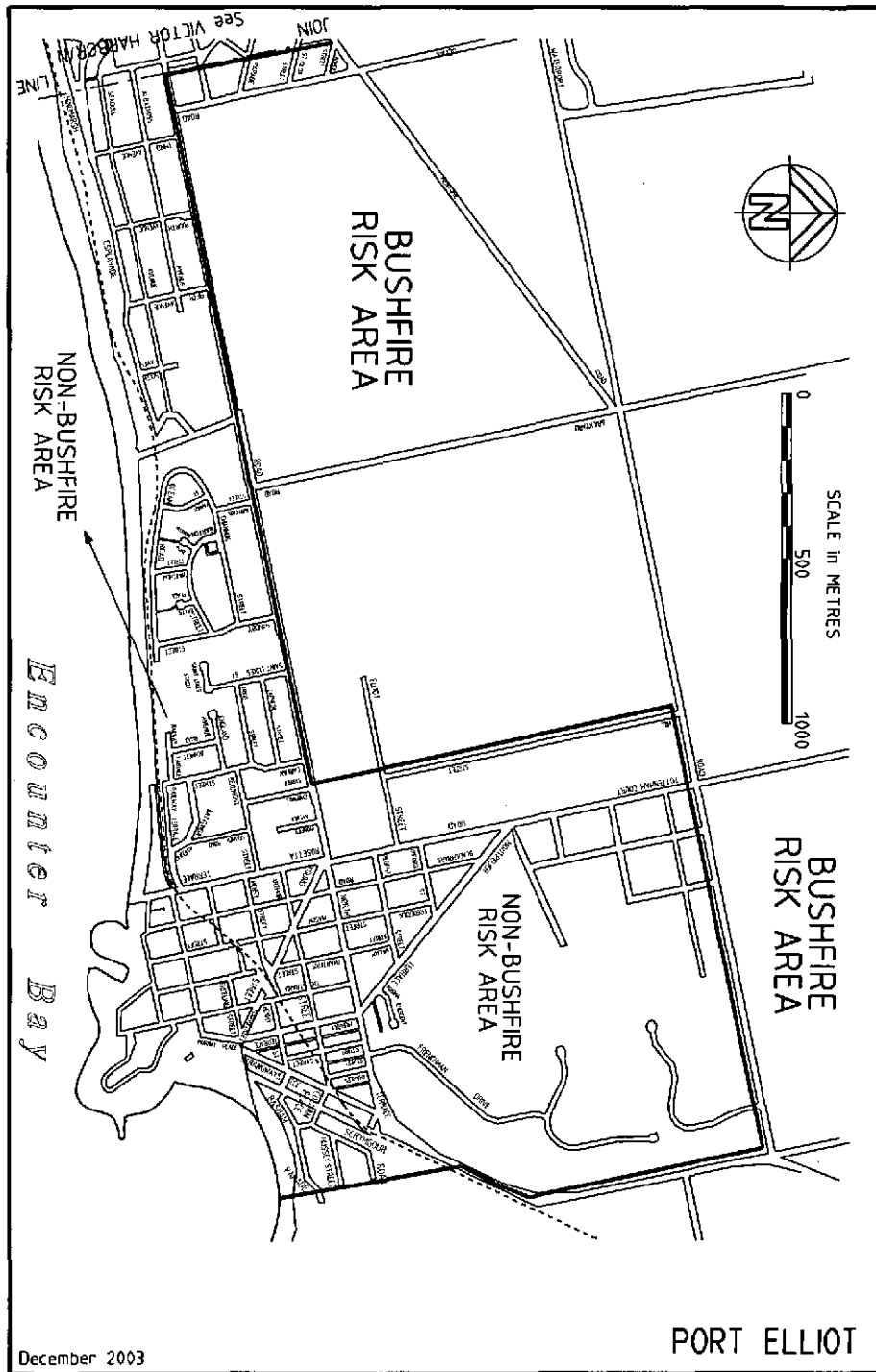

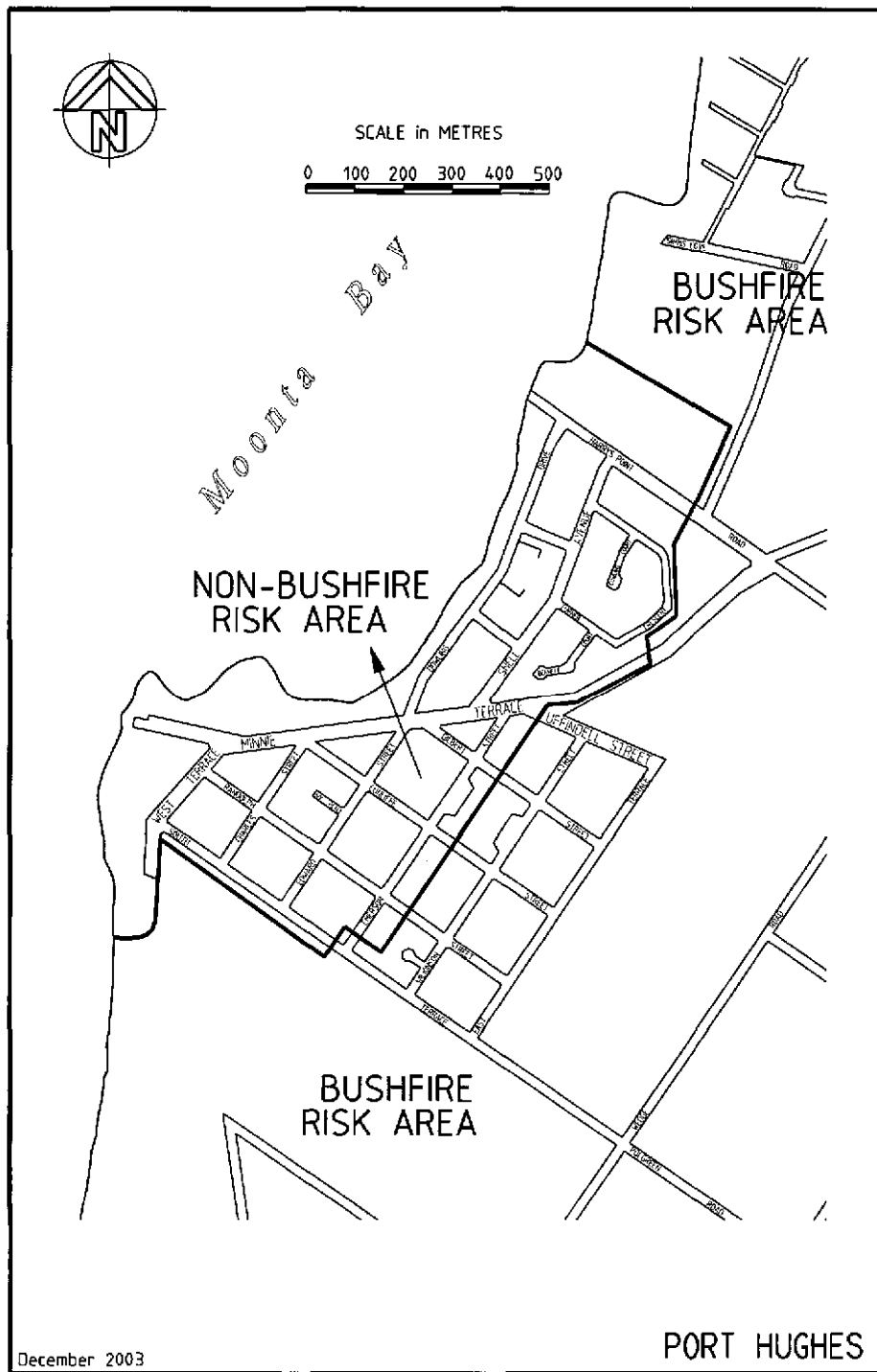

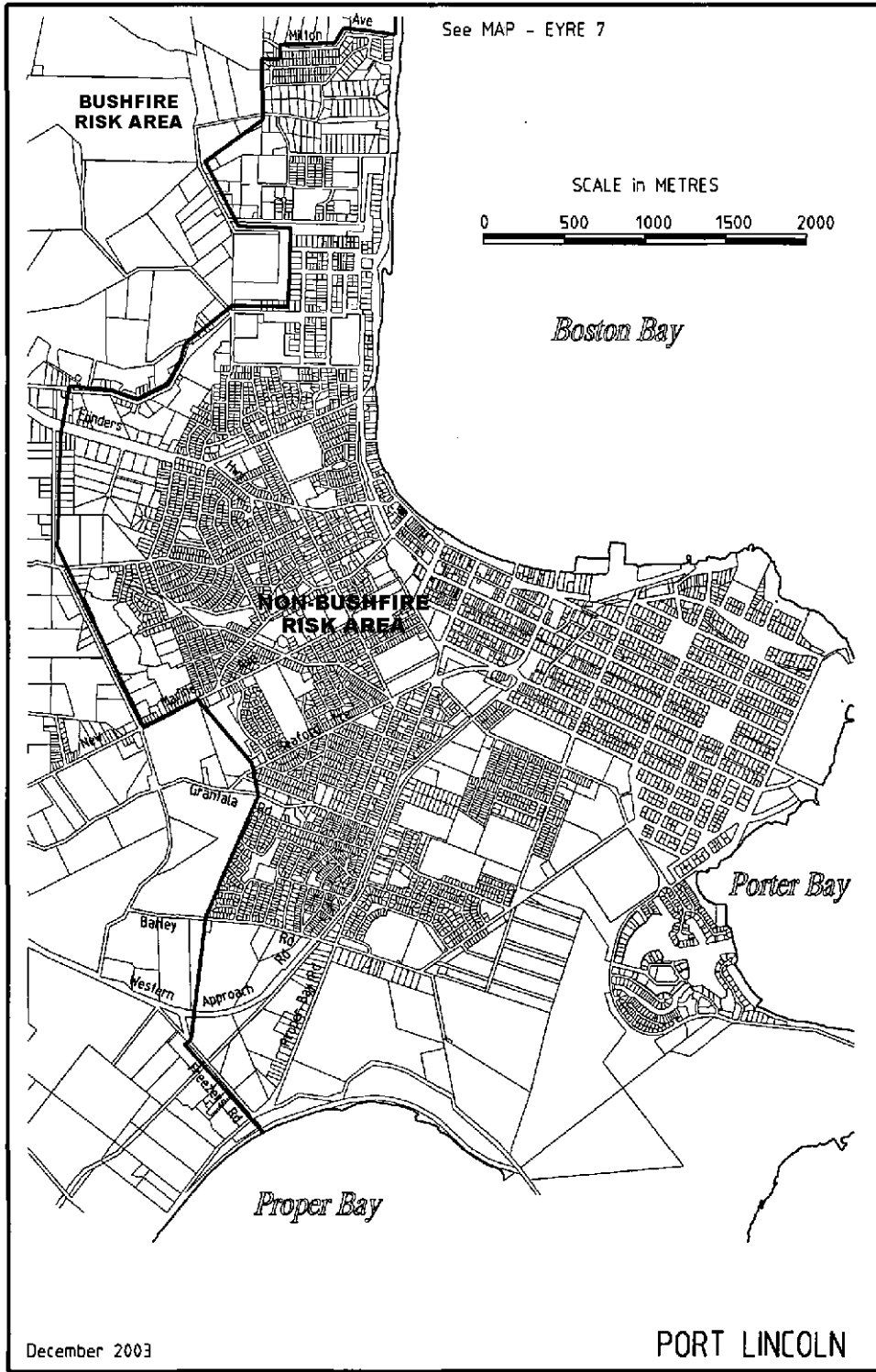

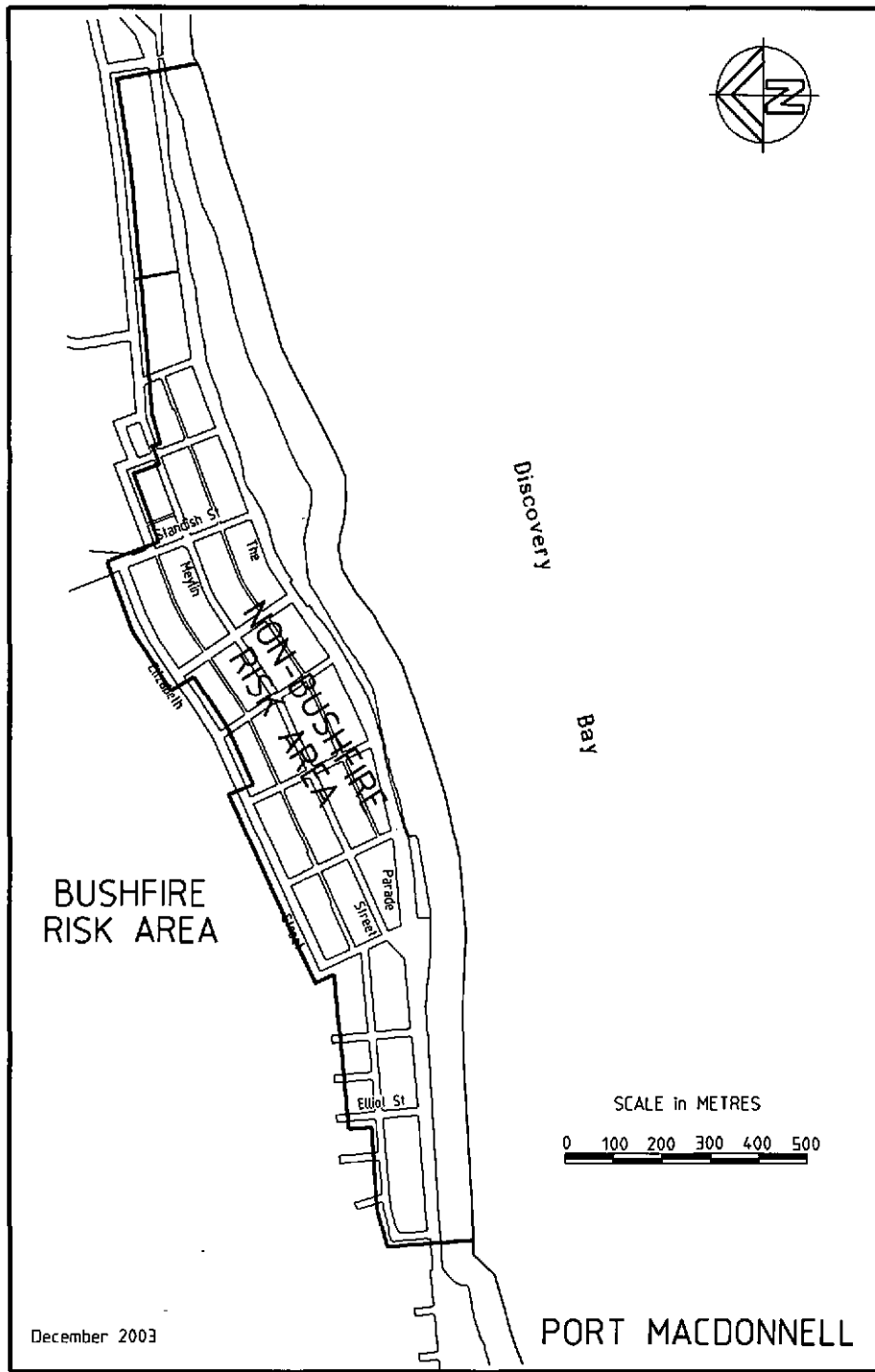

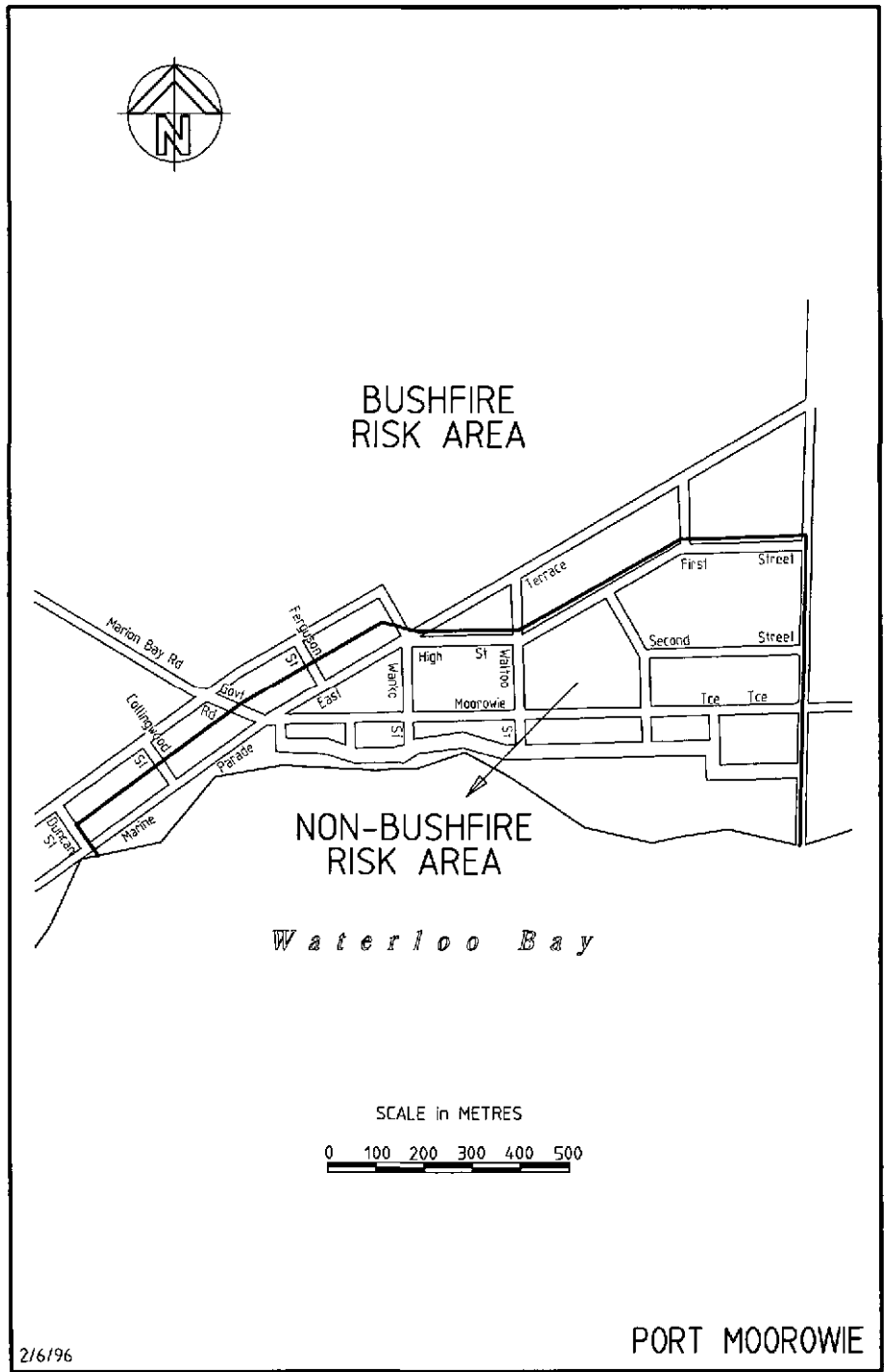

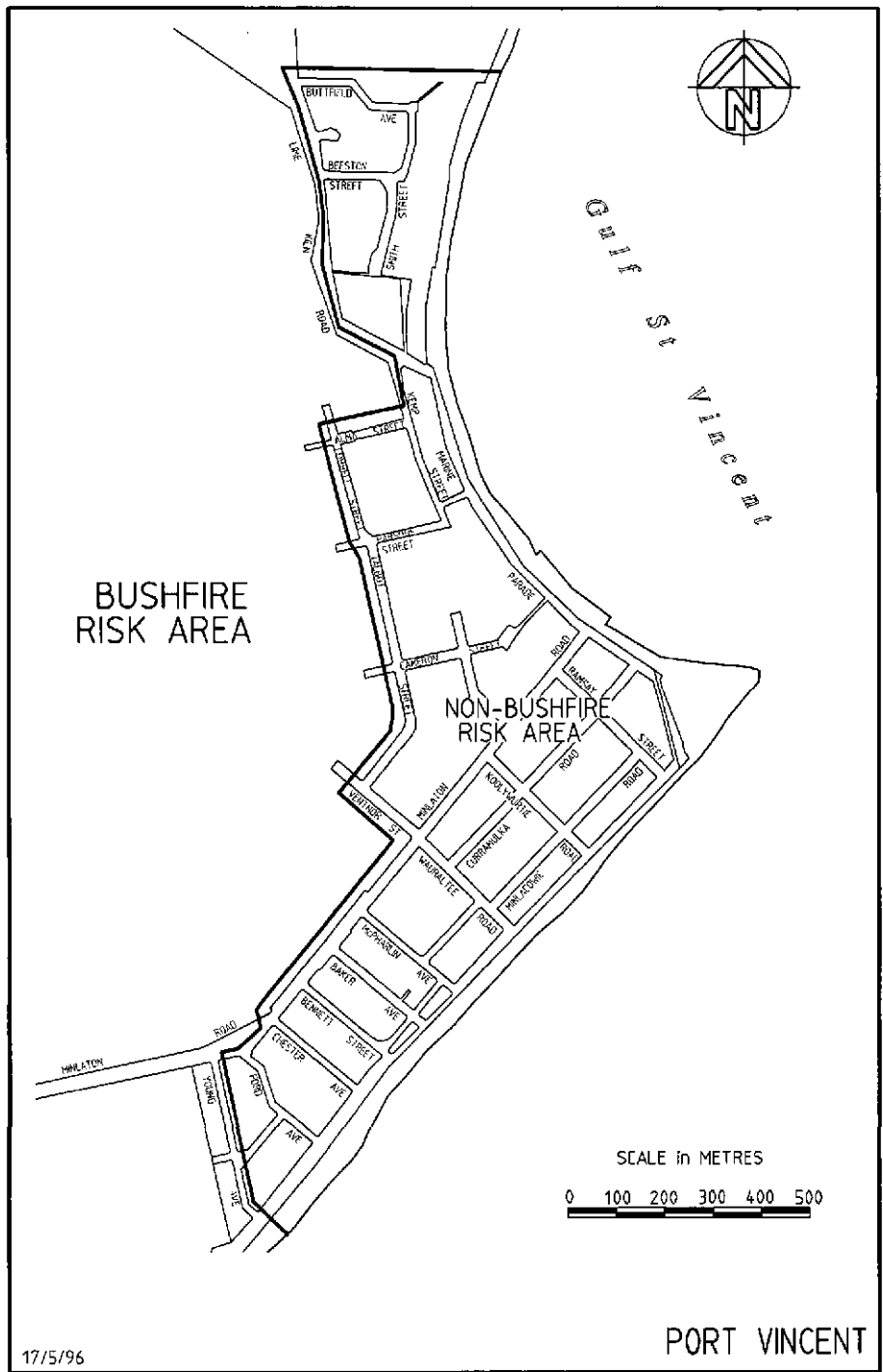

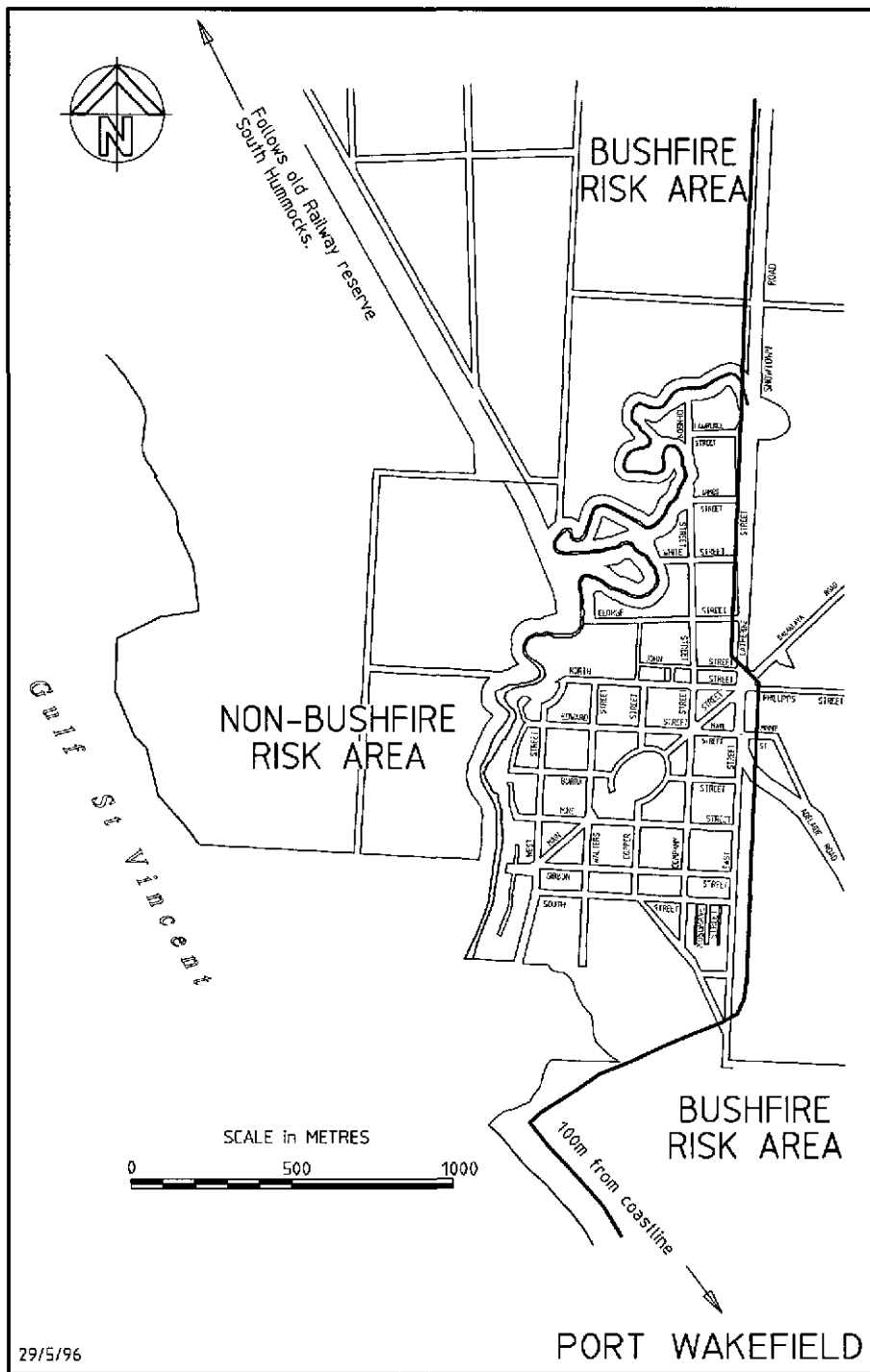

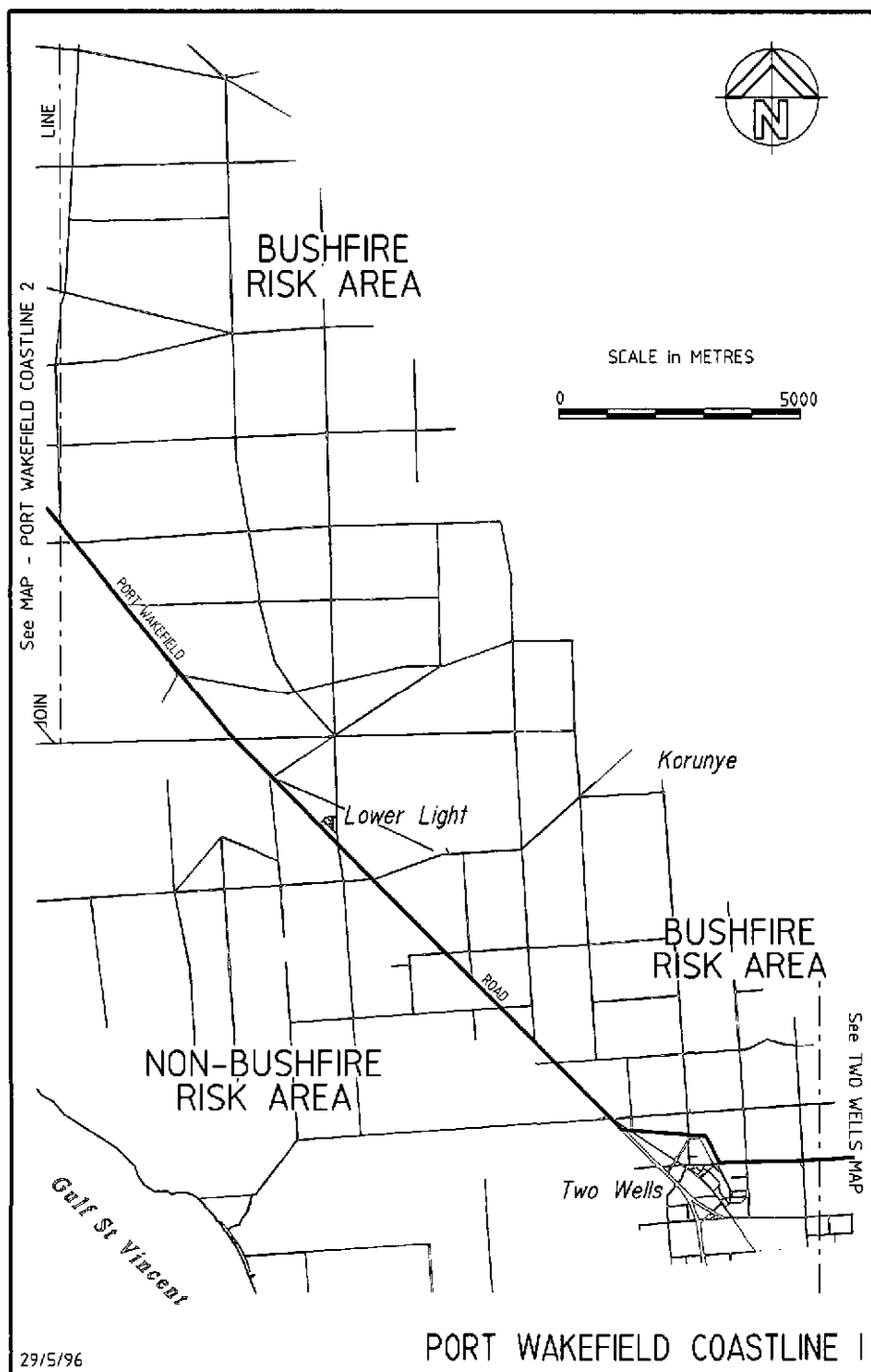

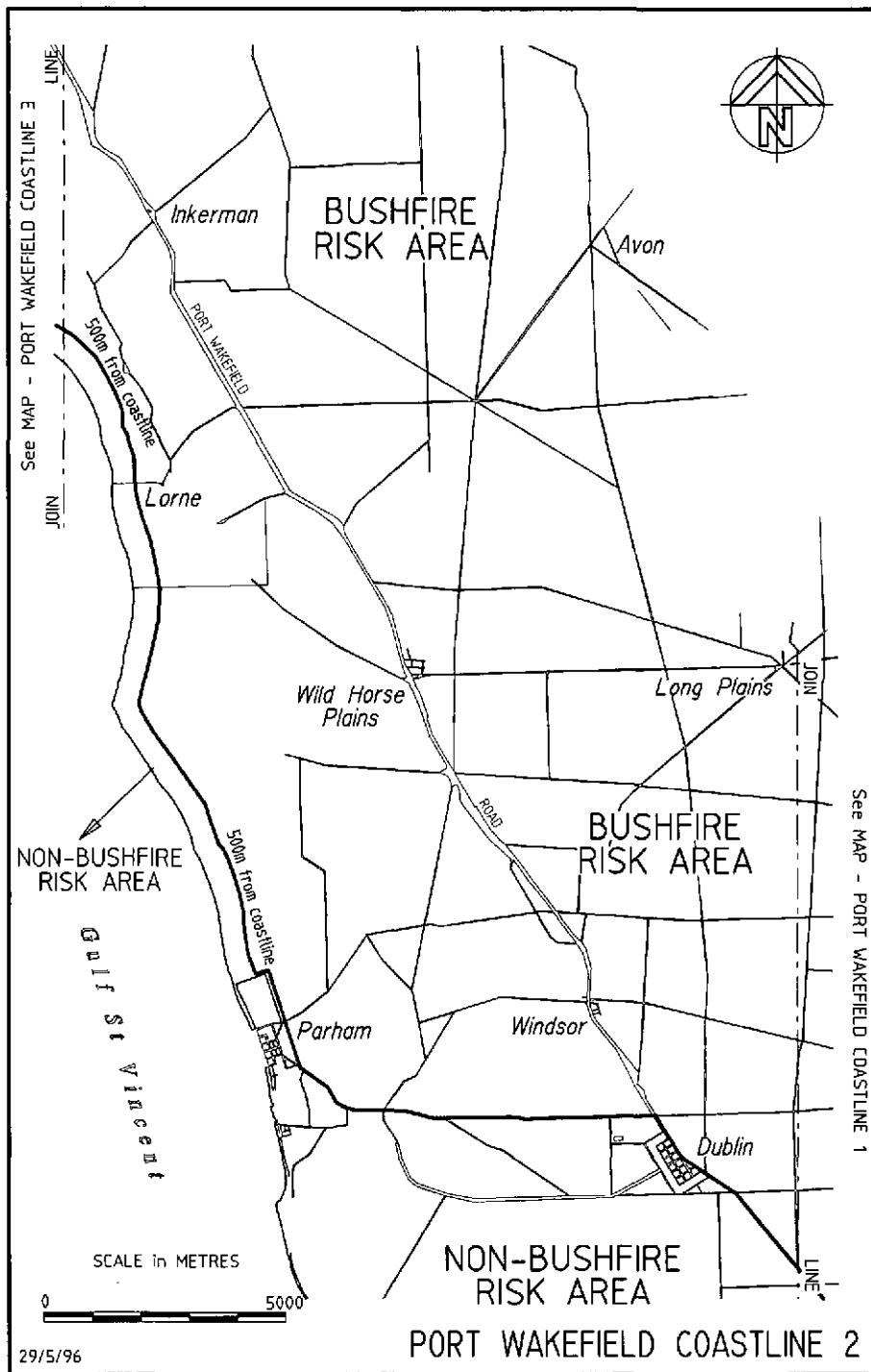

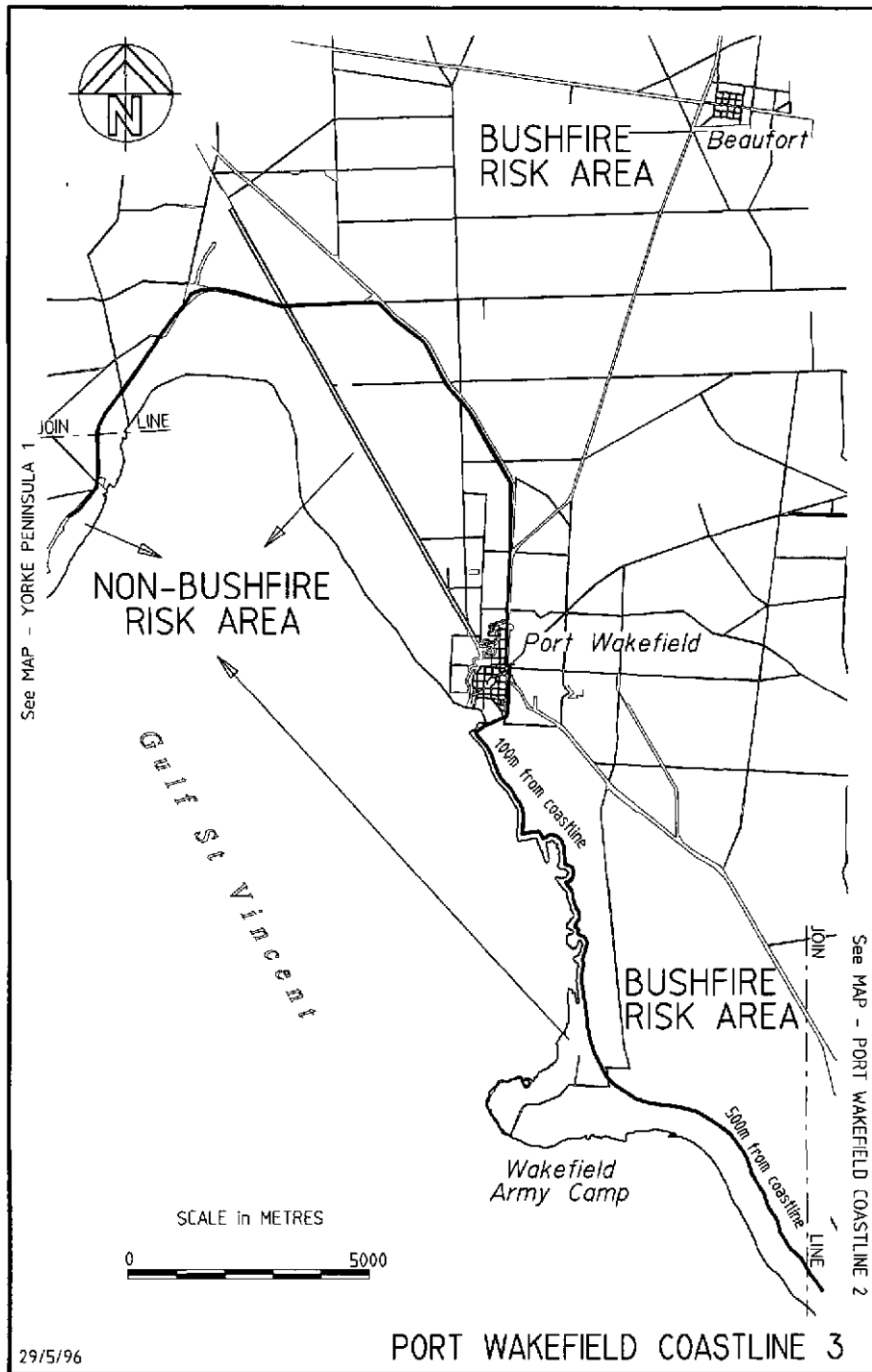

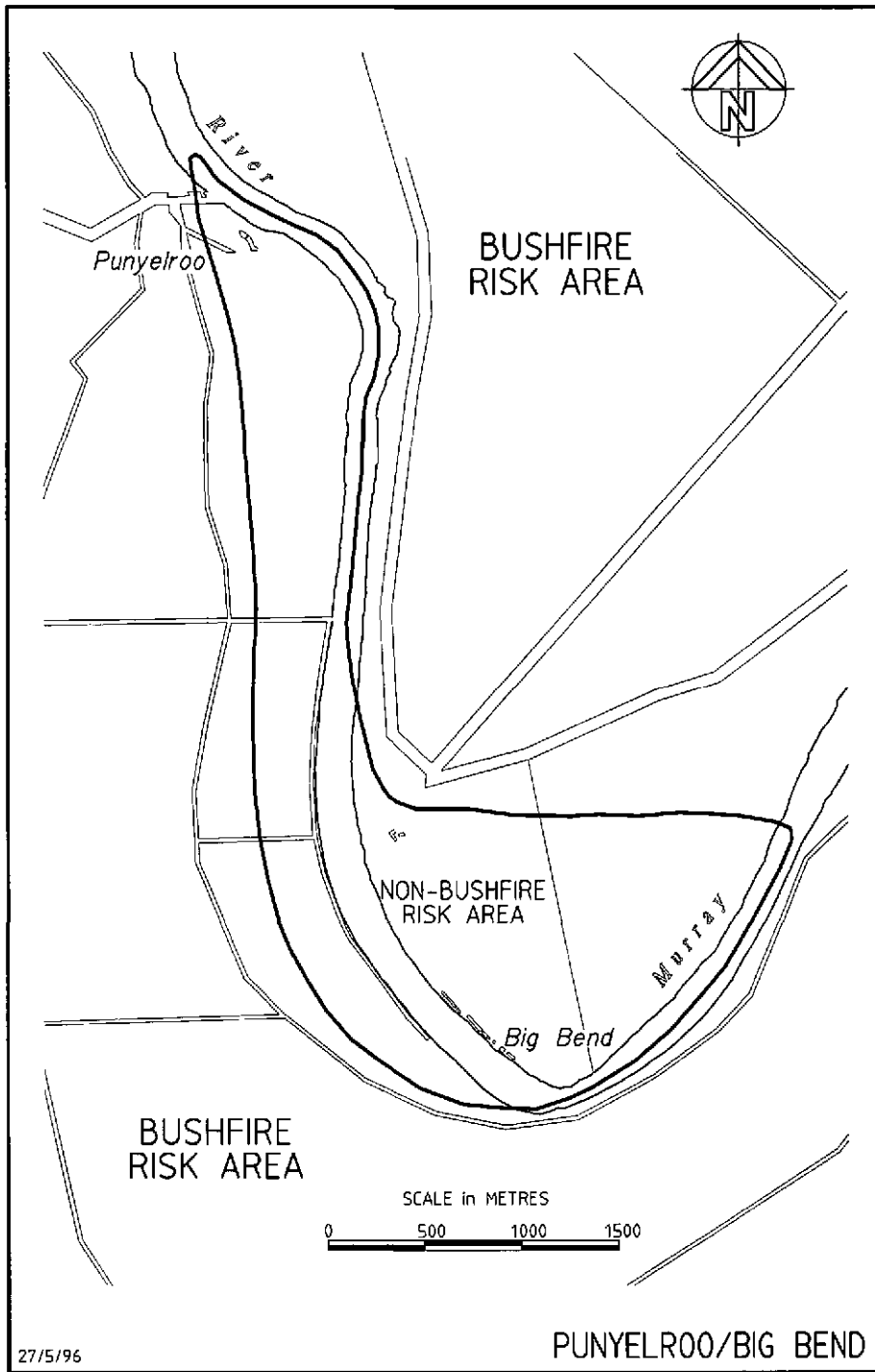

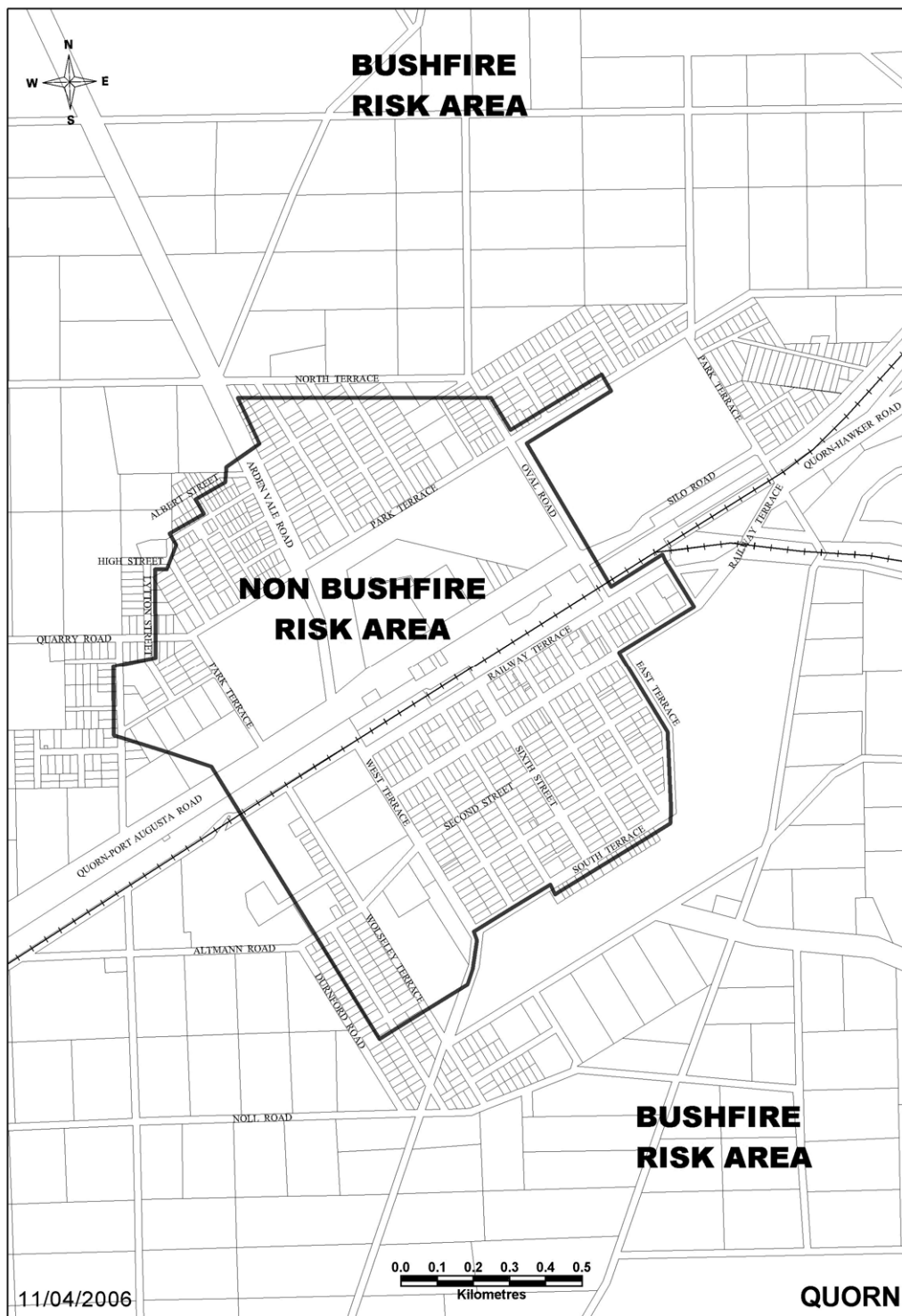

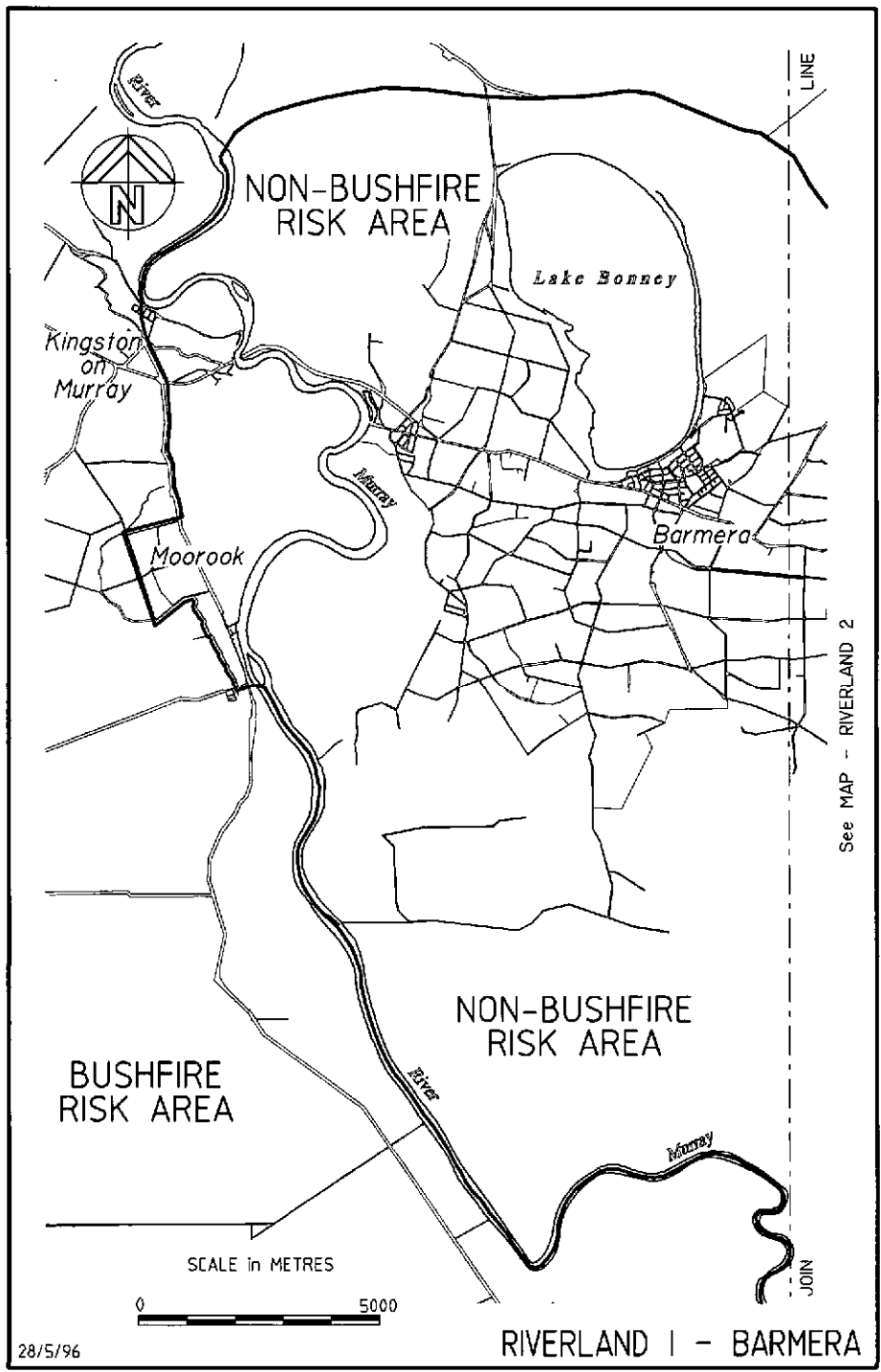

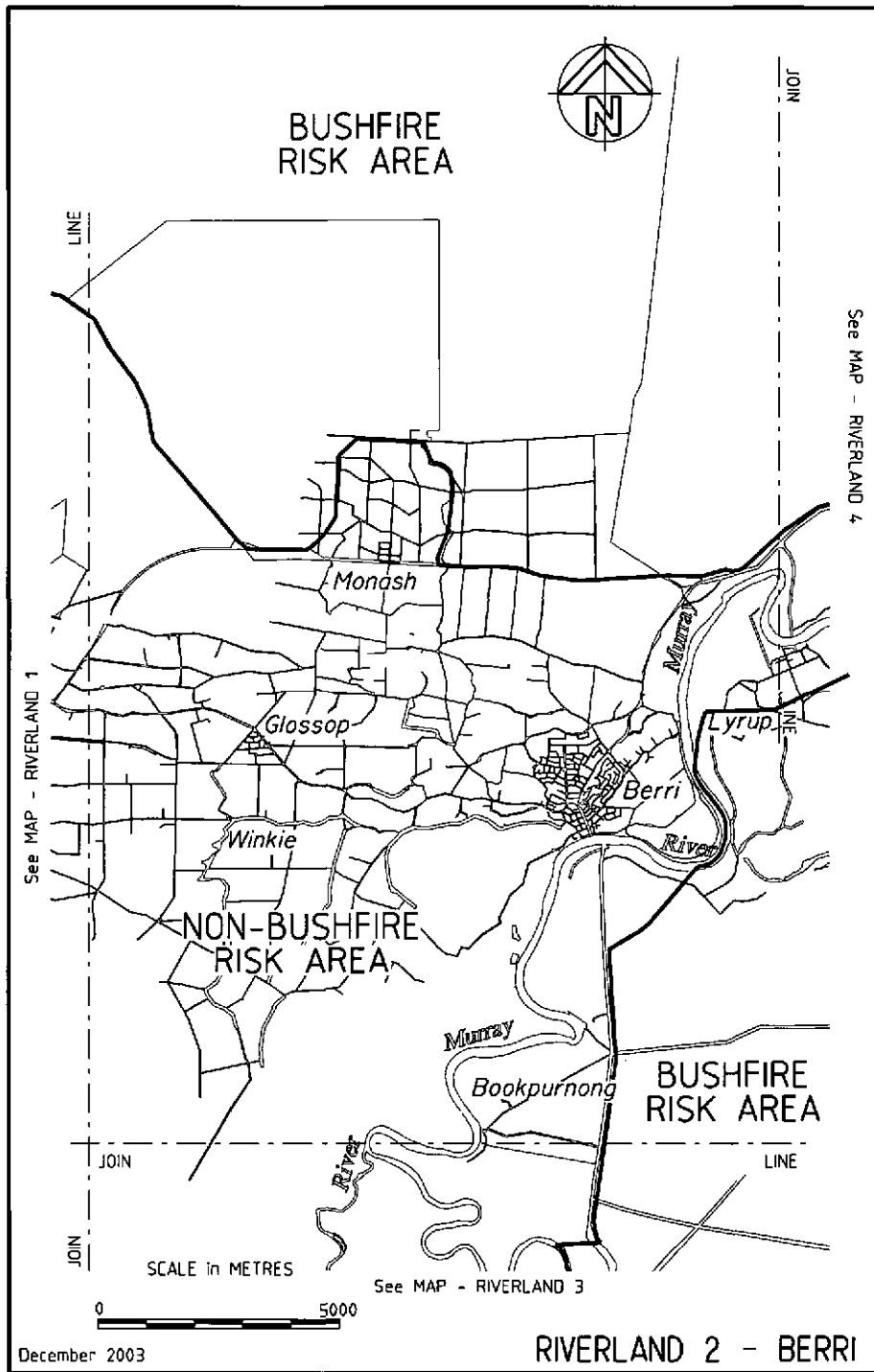

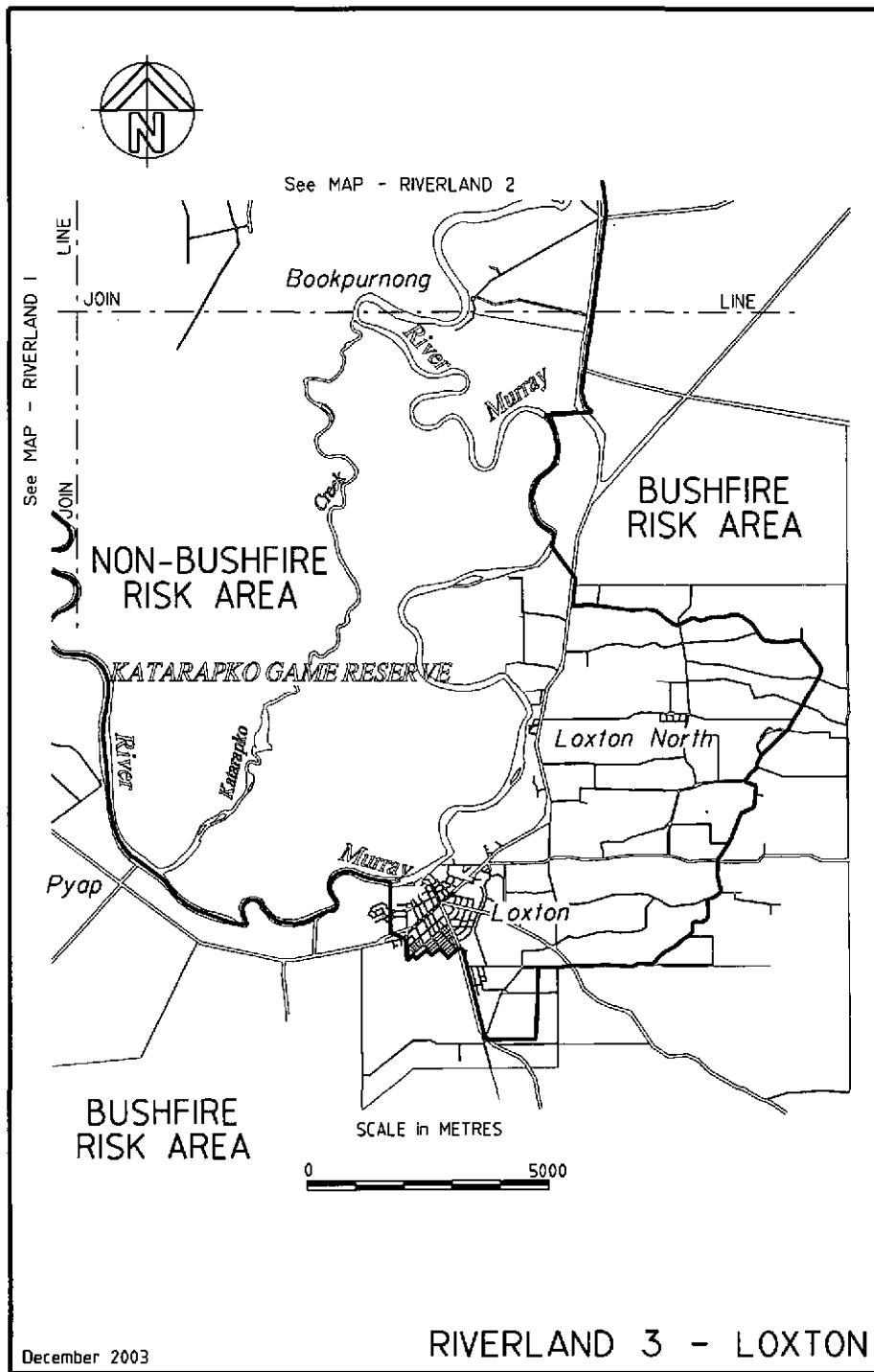

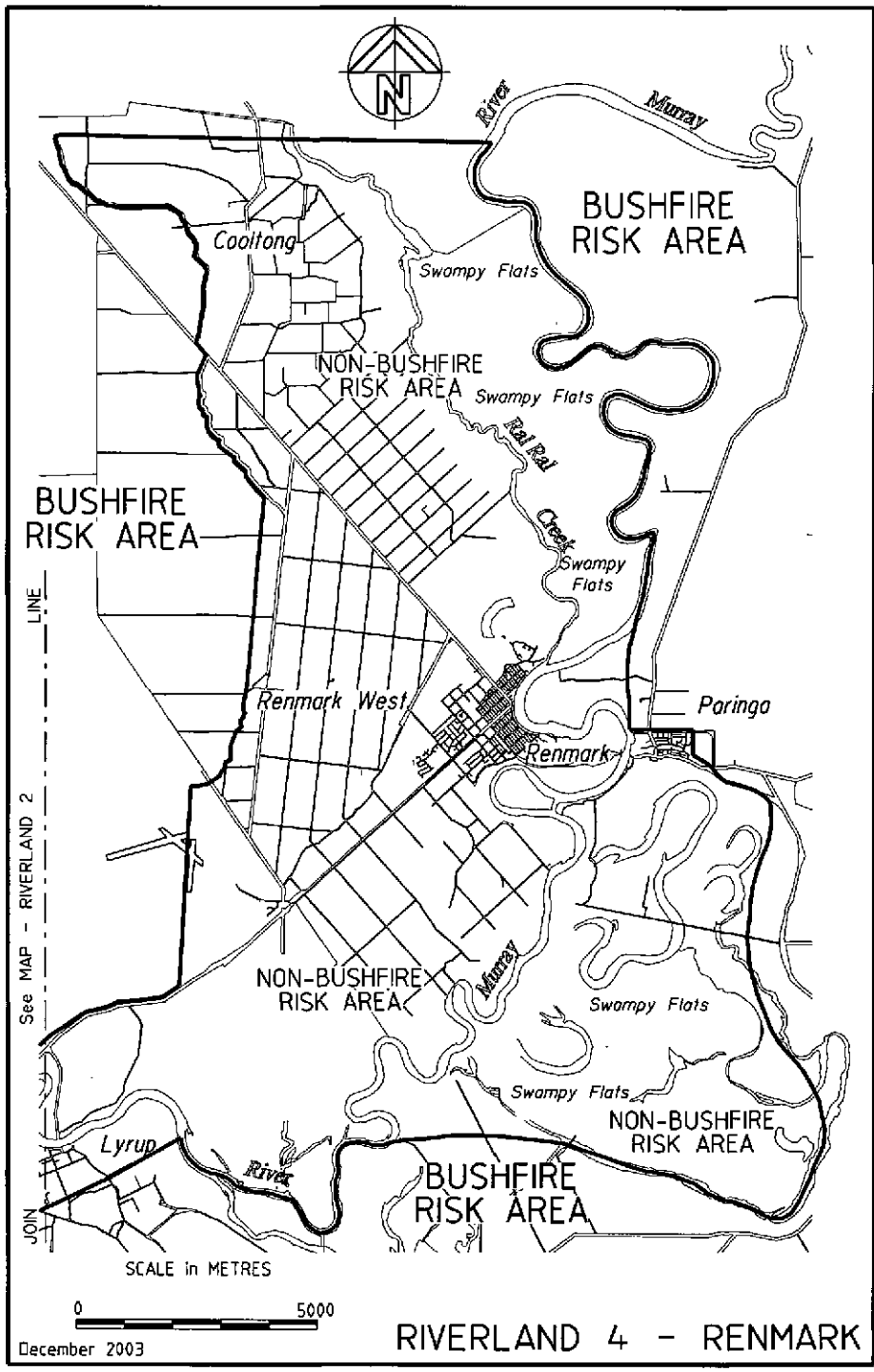

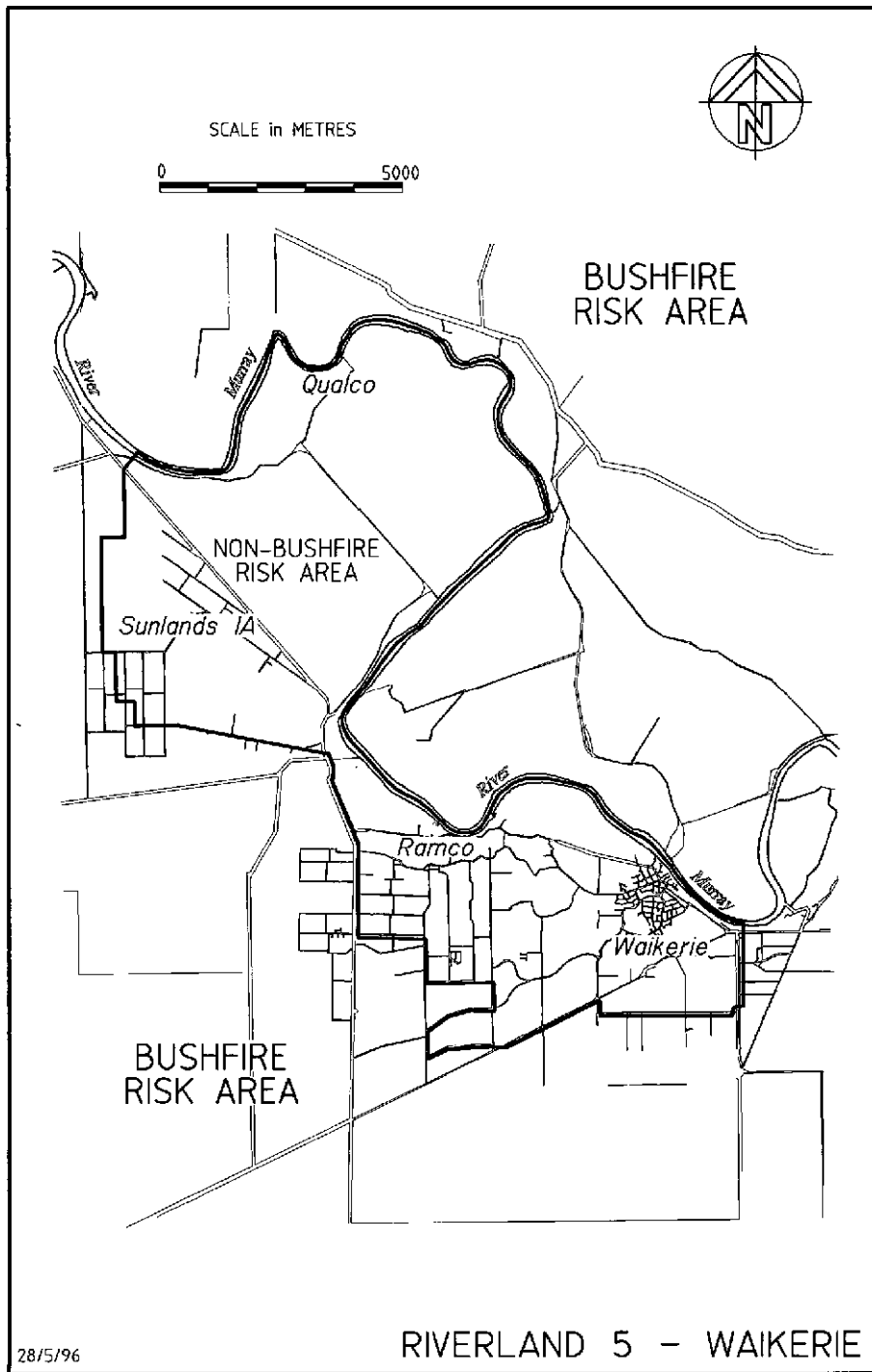

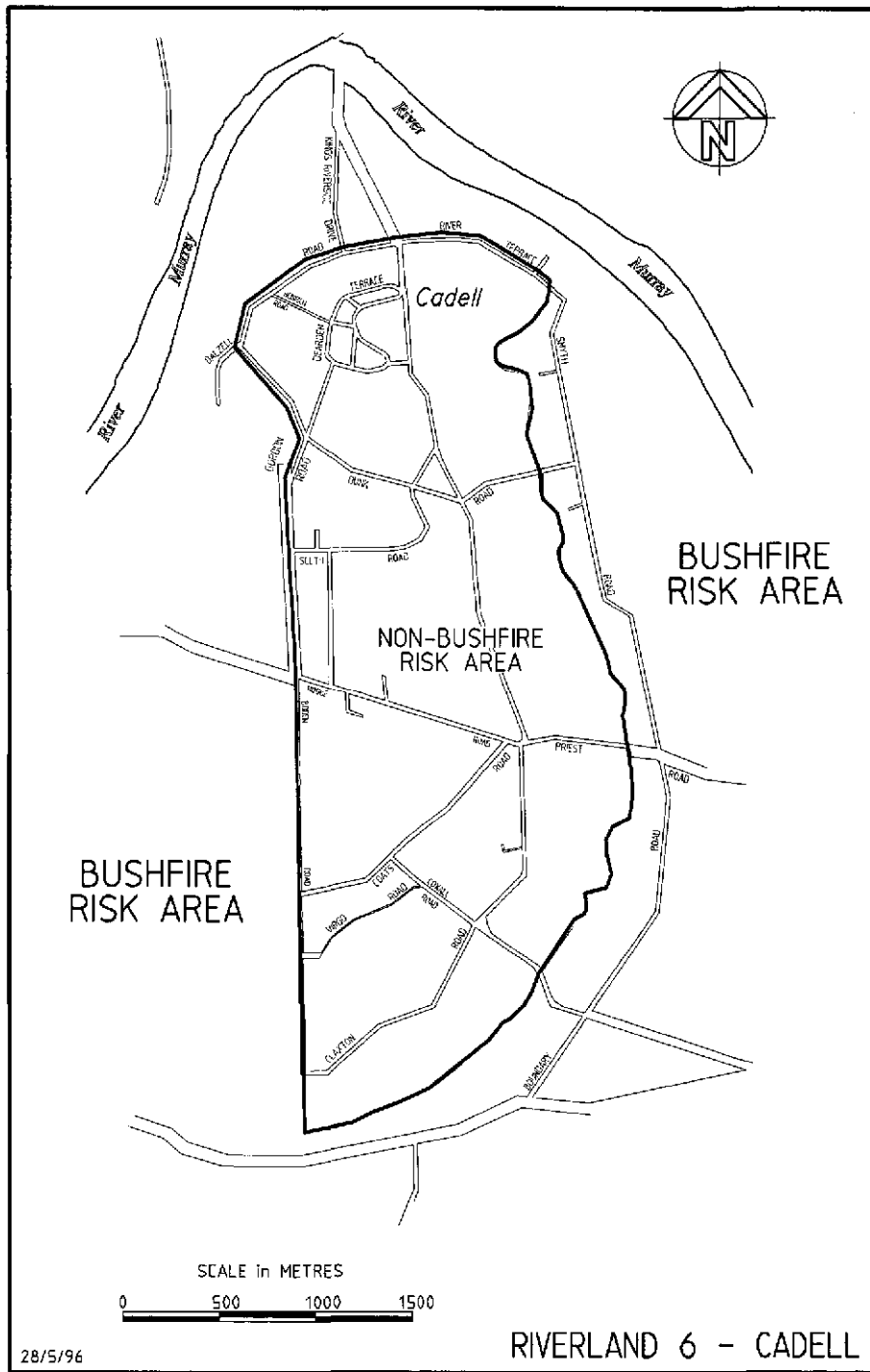

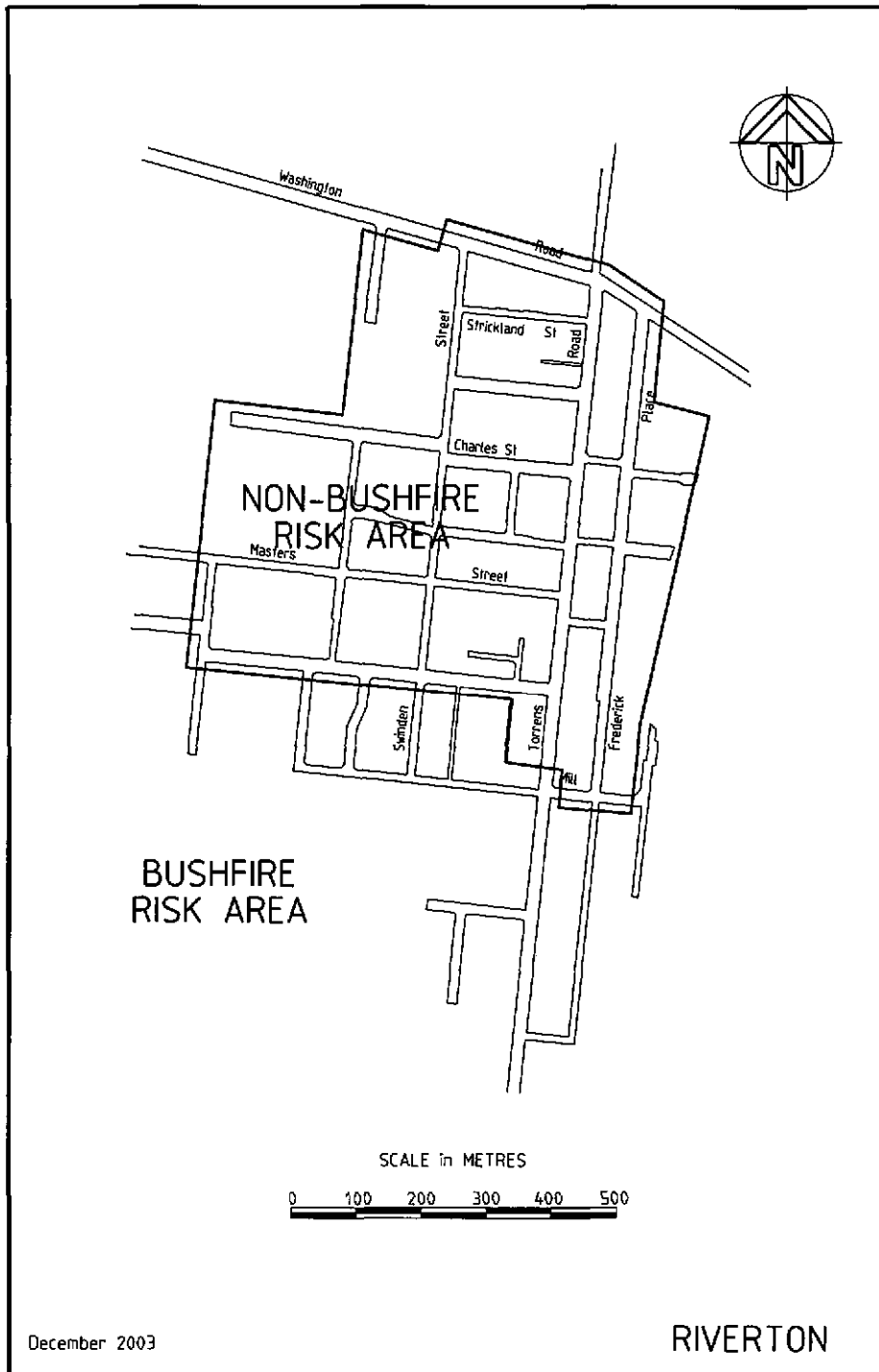

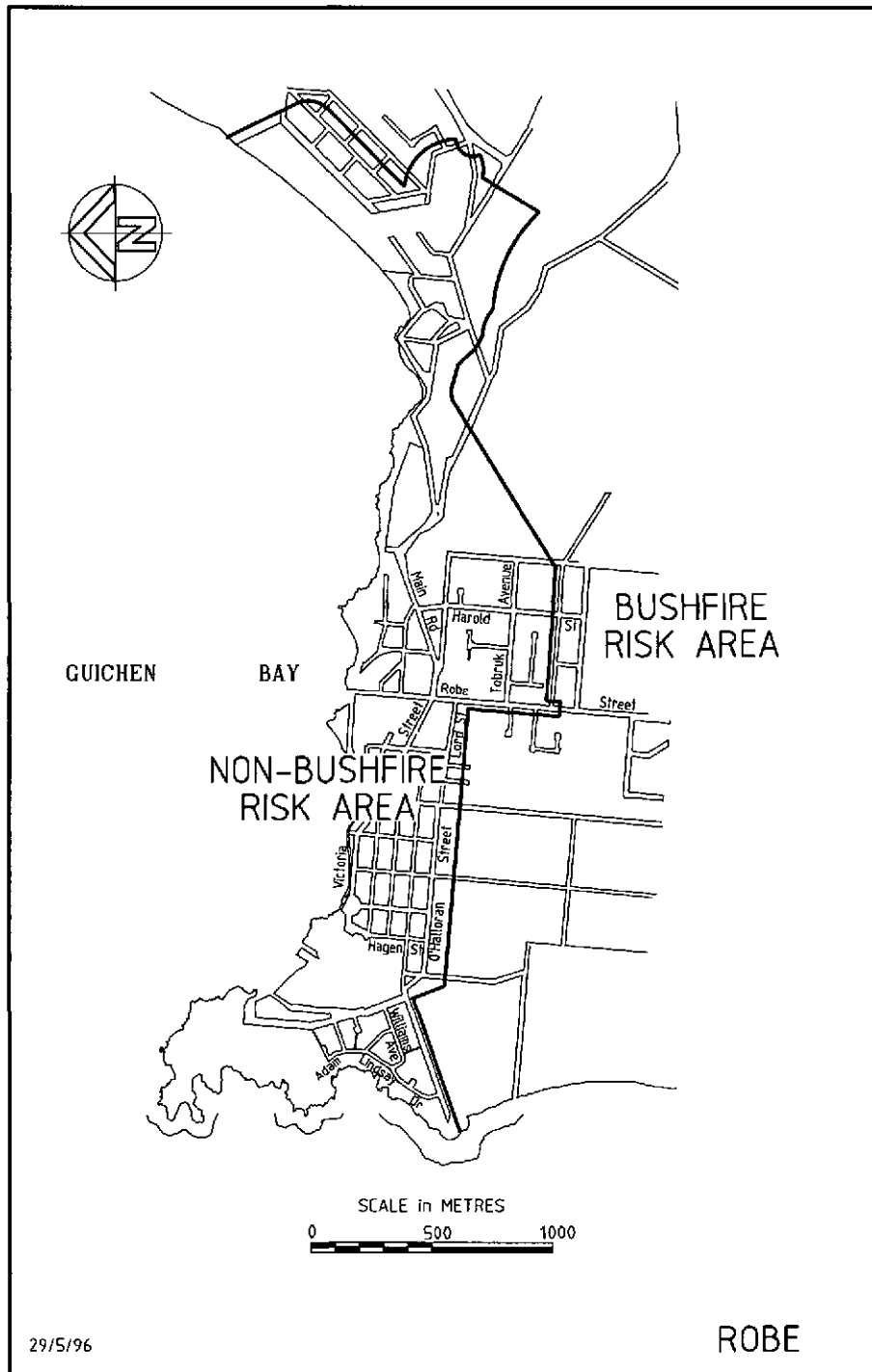

29/5/96

ROBE

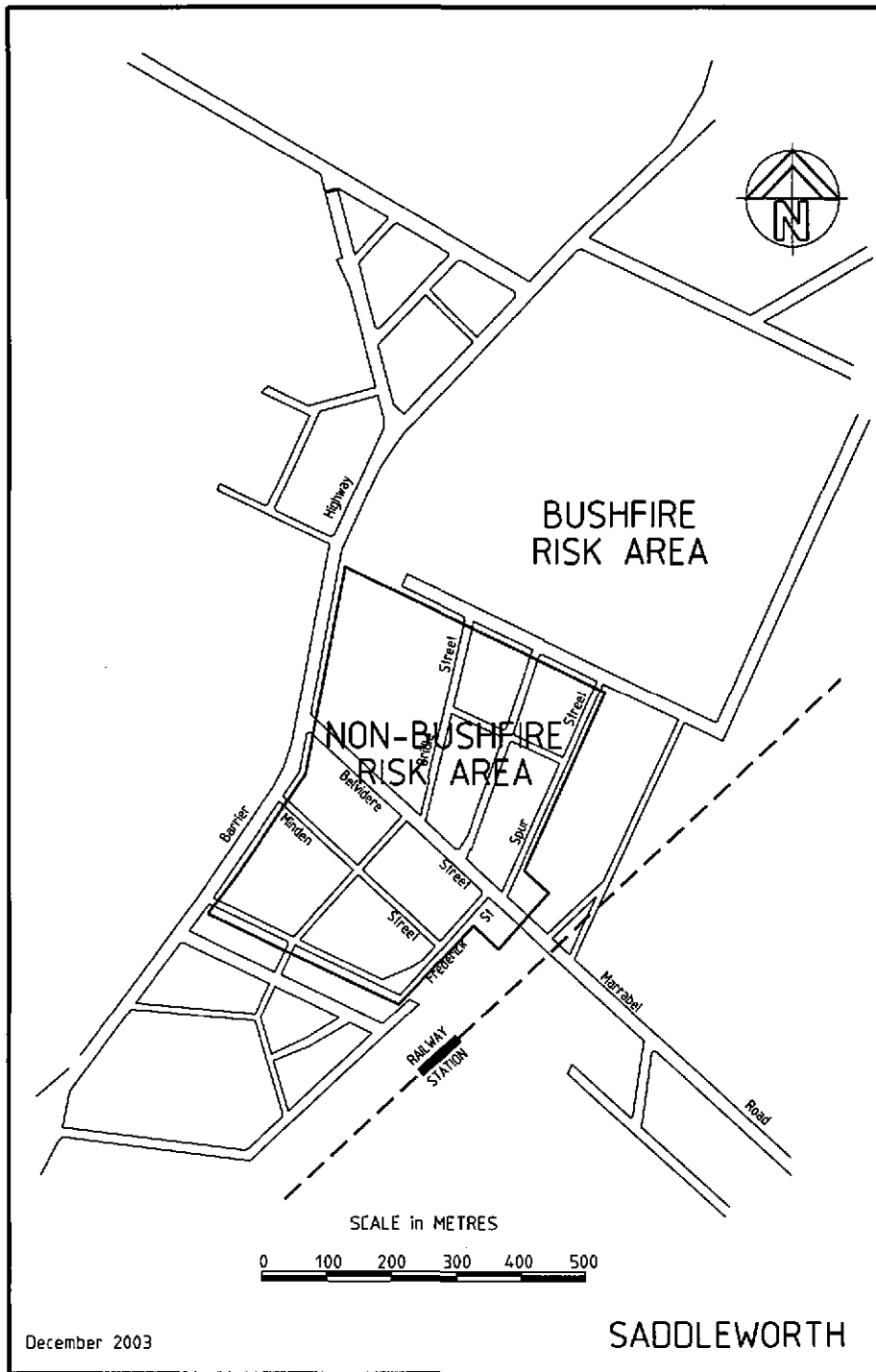

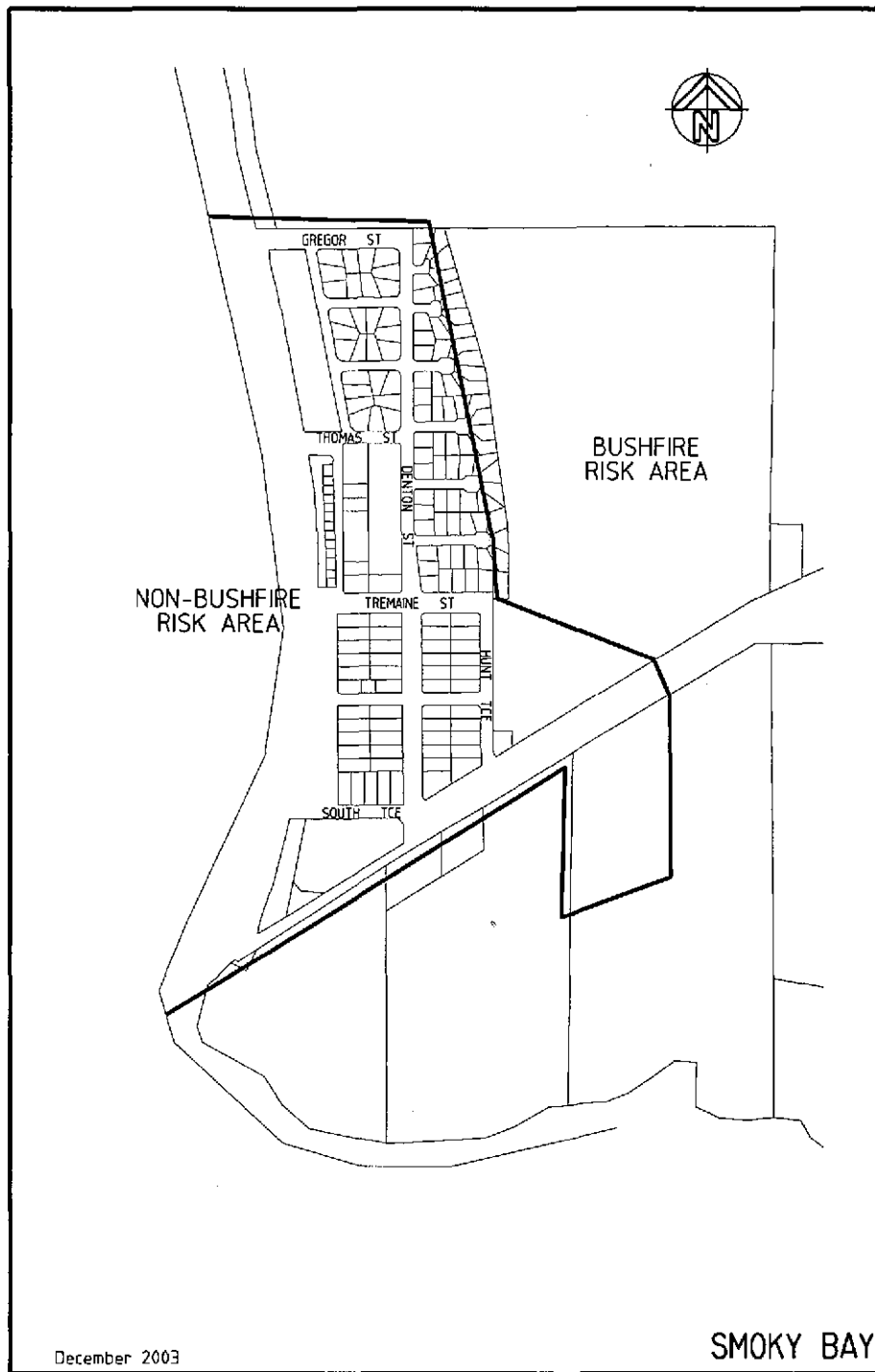

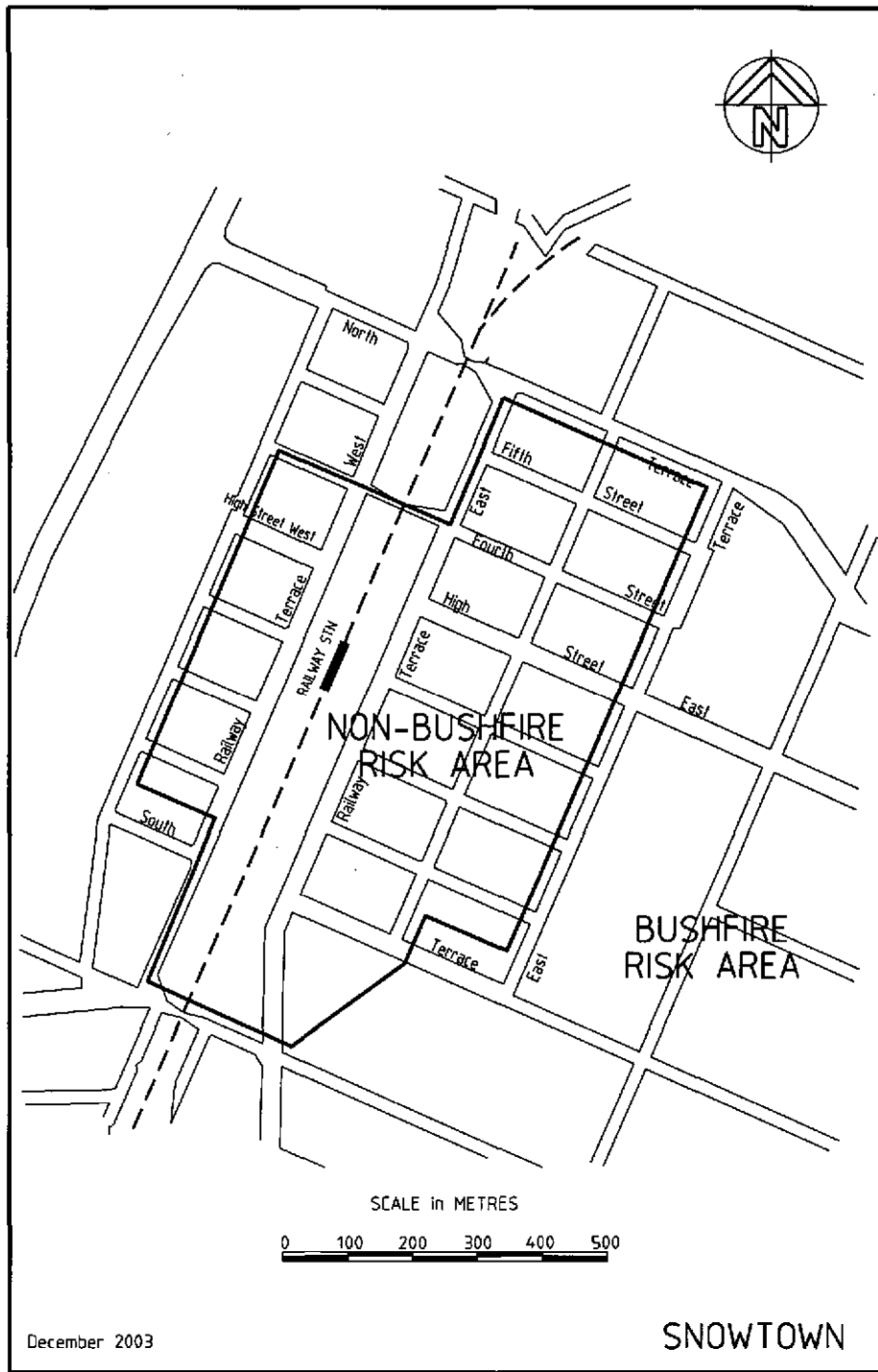

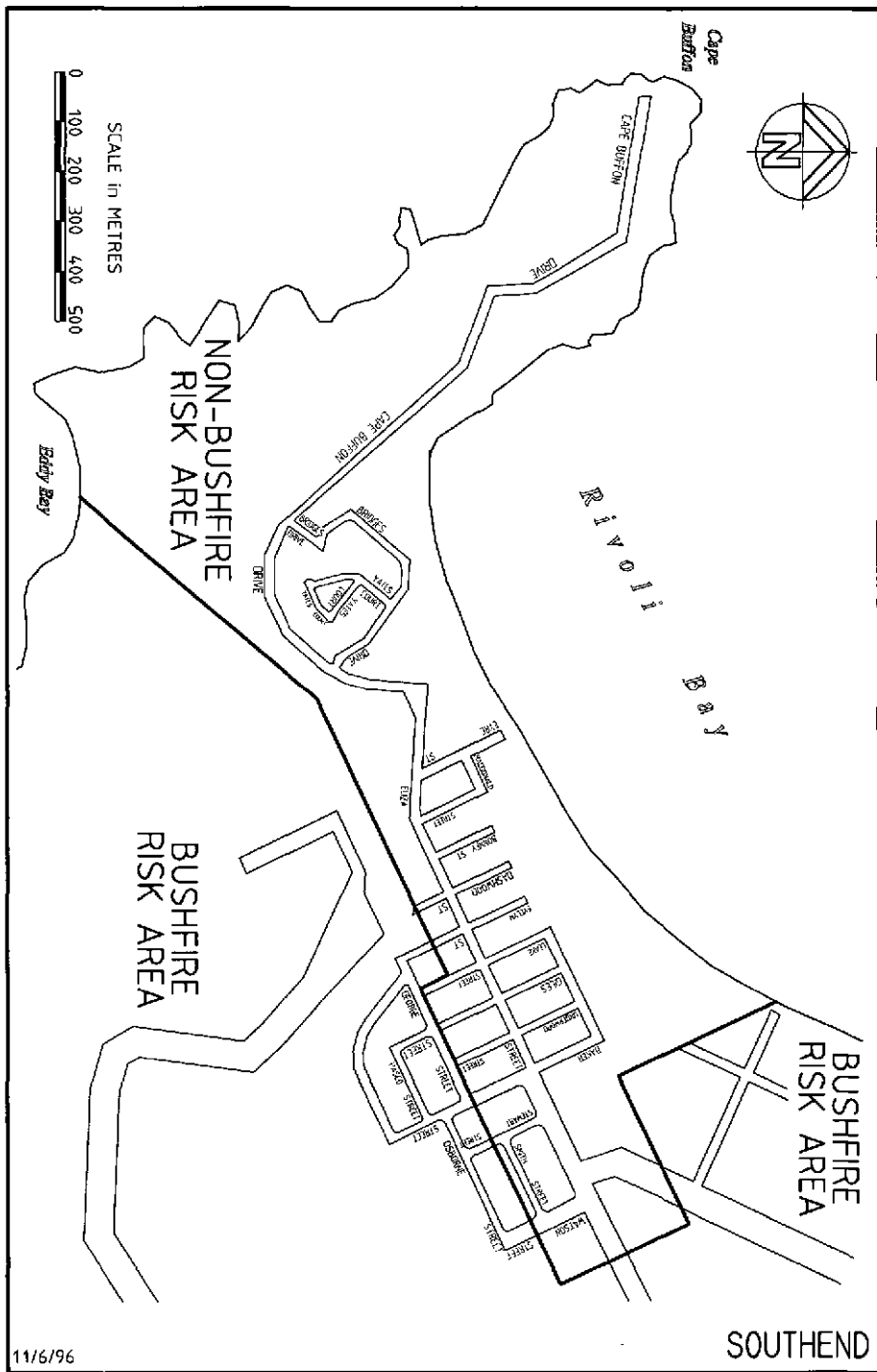

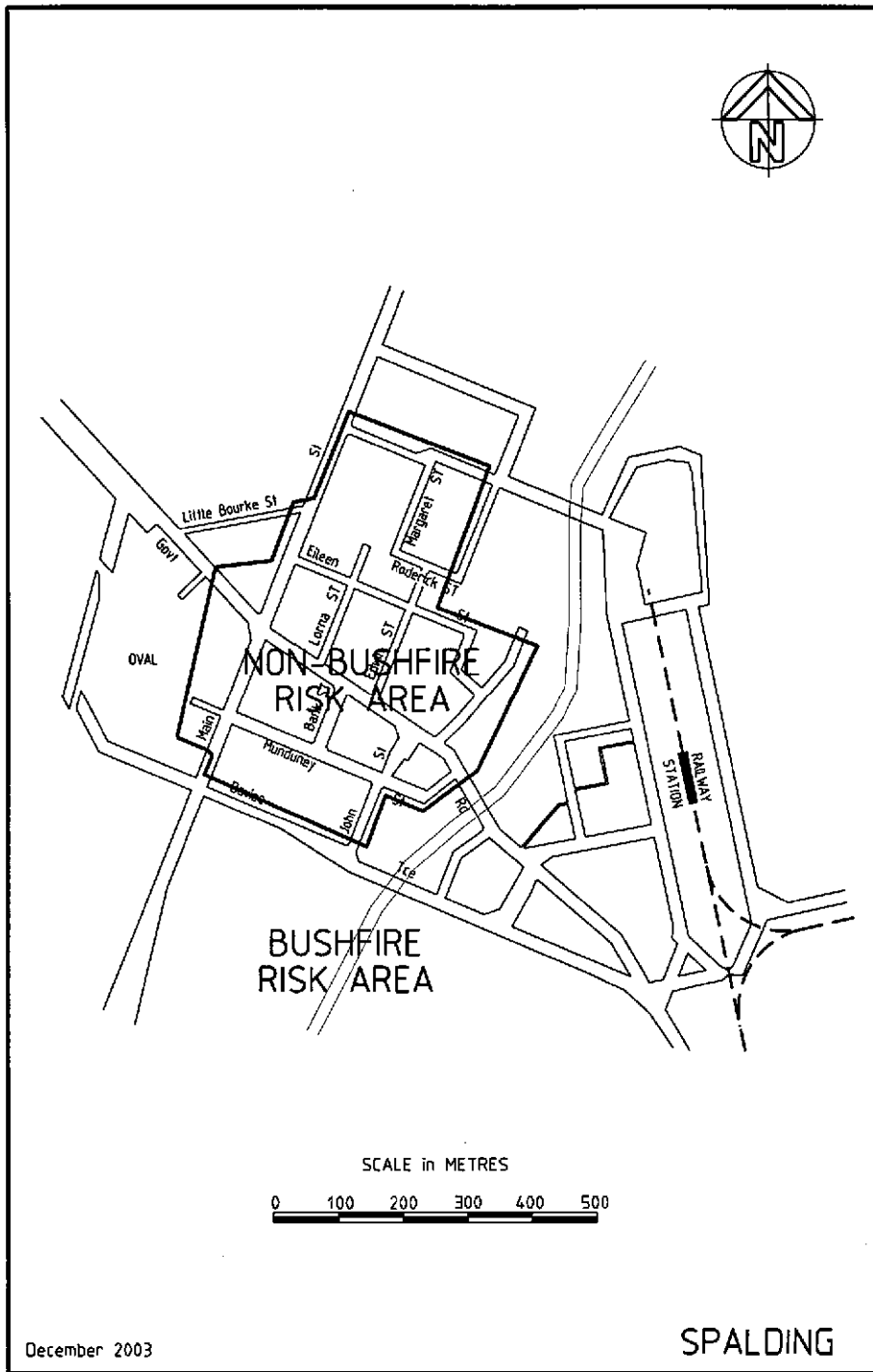

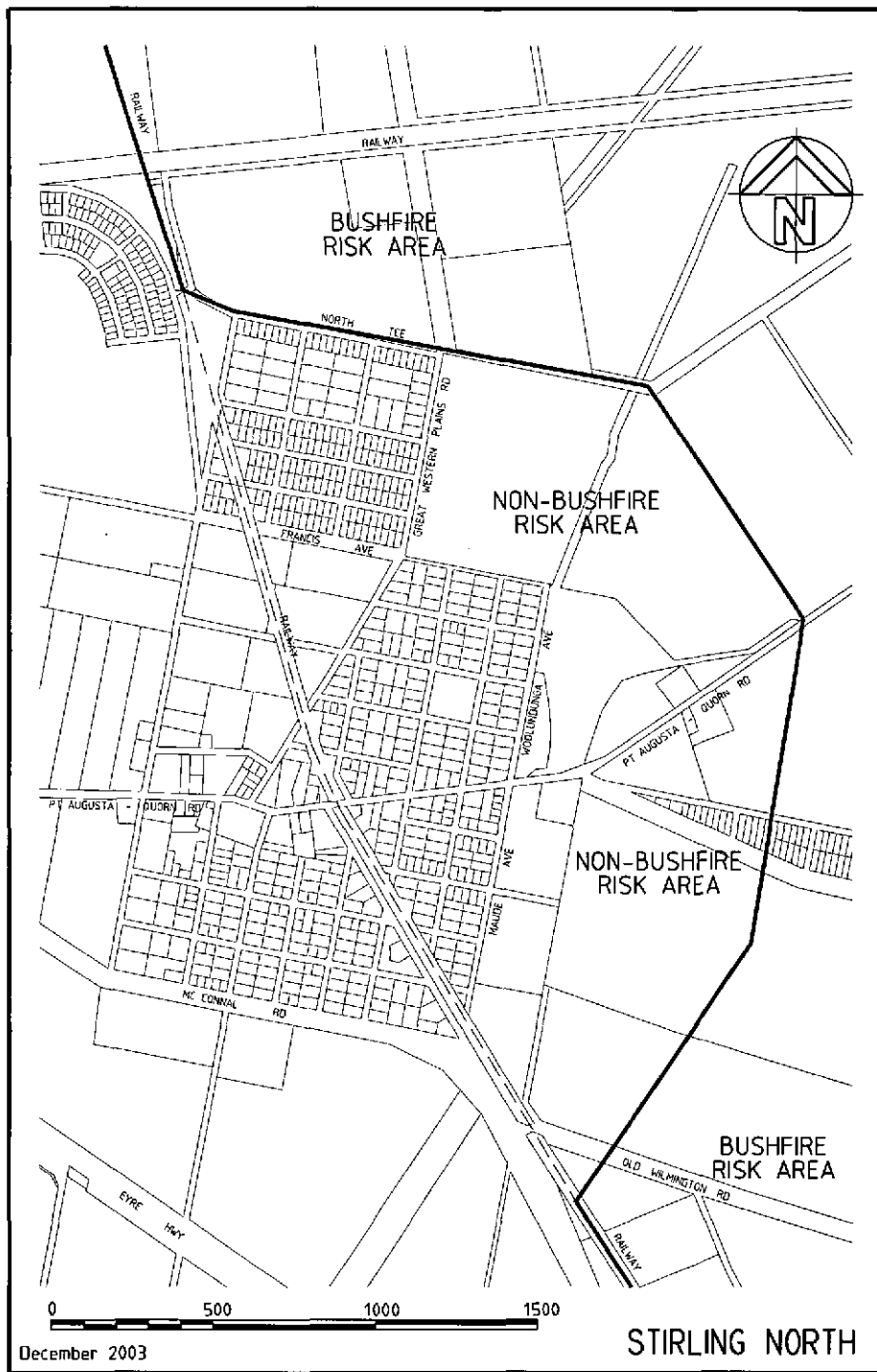

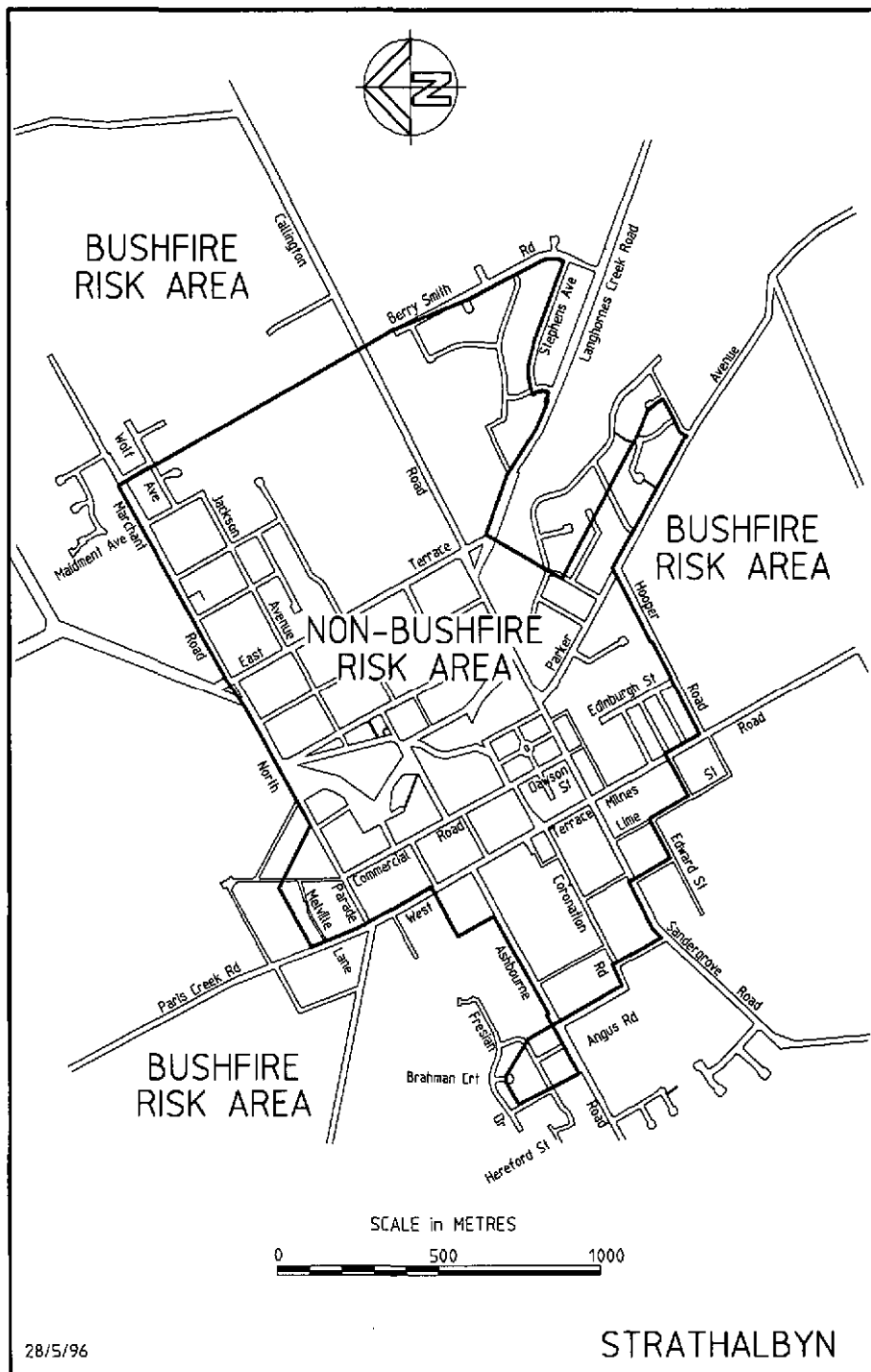

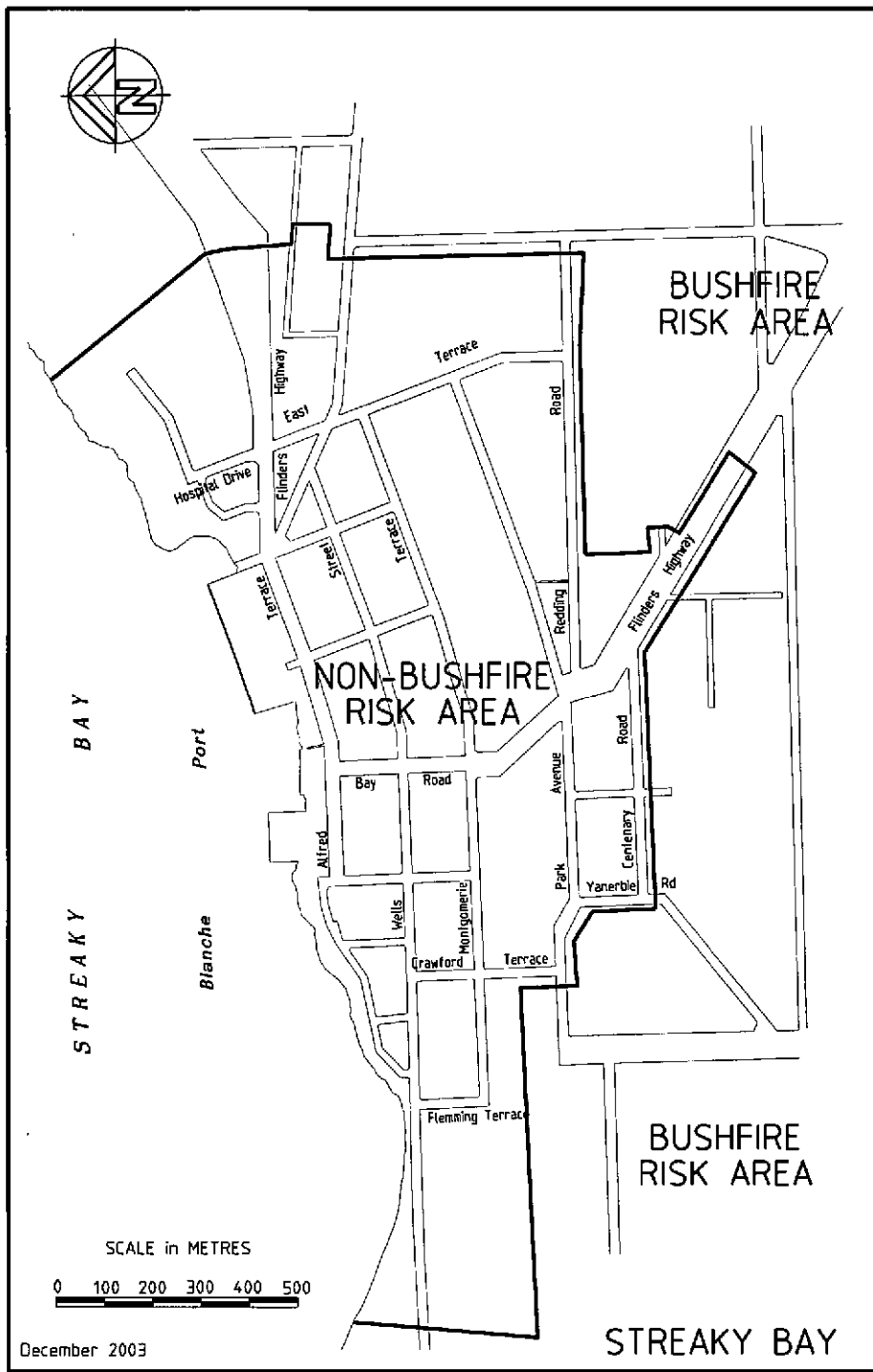

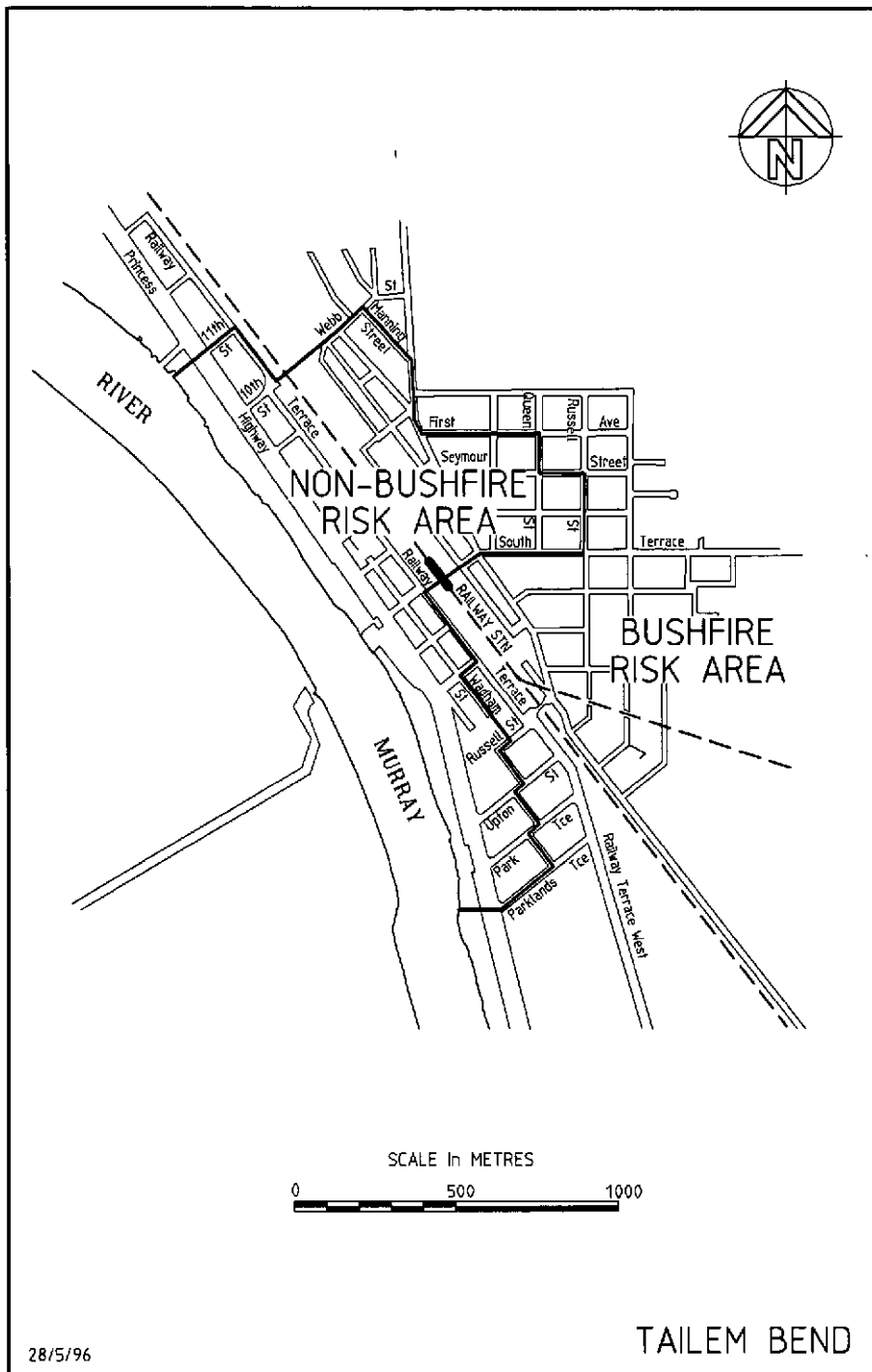

28/5/96

TAILEM BEND

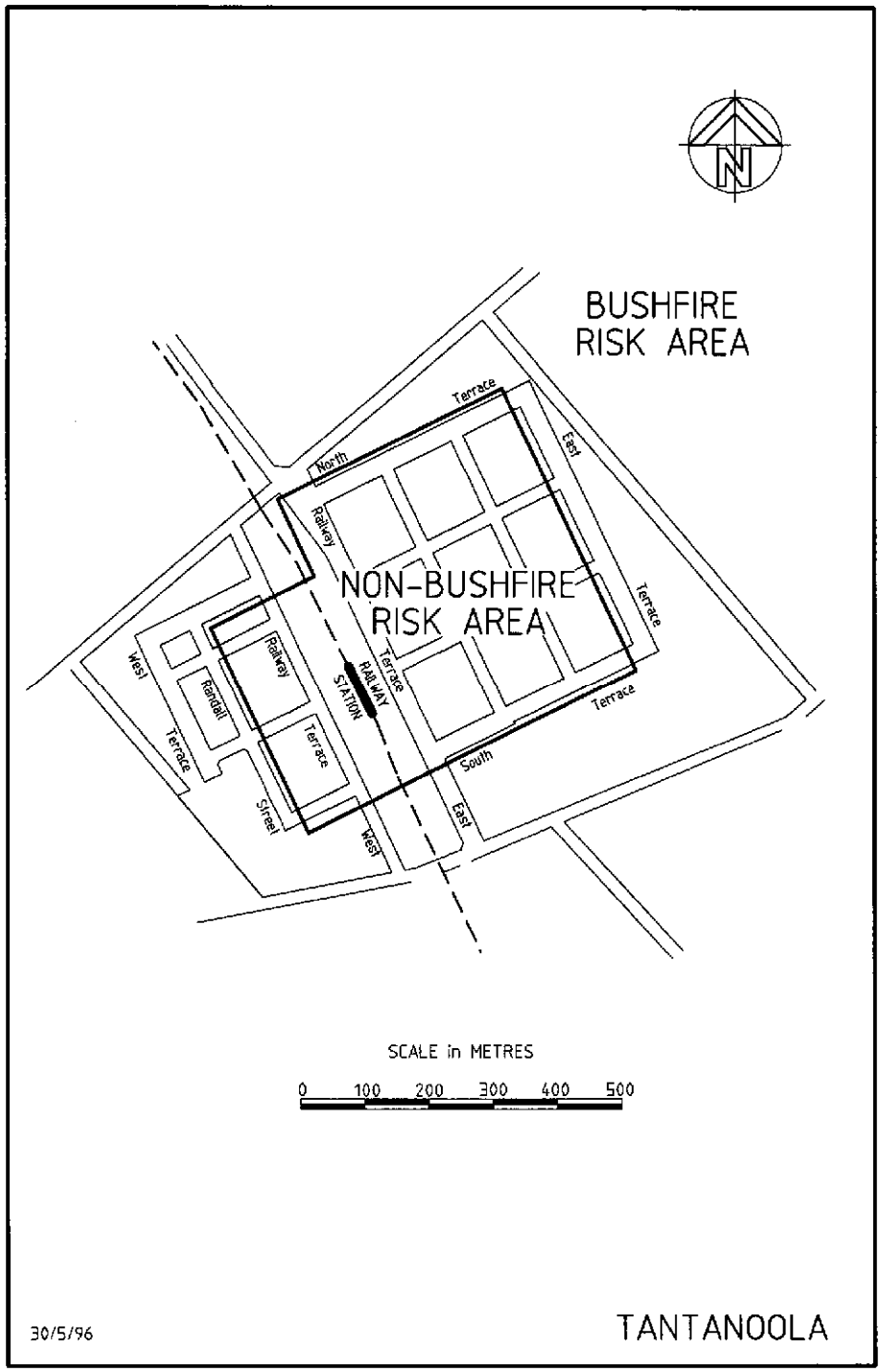

30/5/96

TANTANOOLA

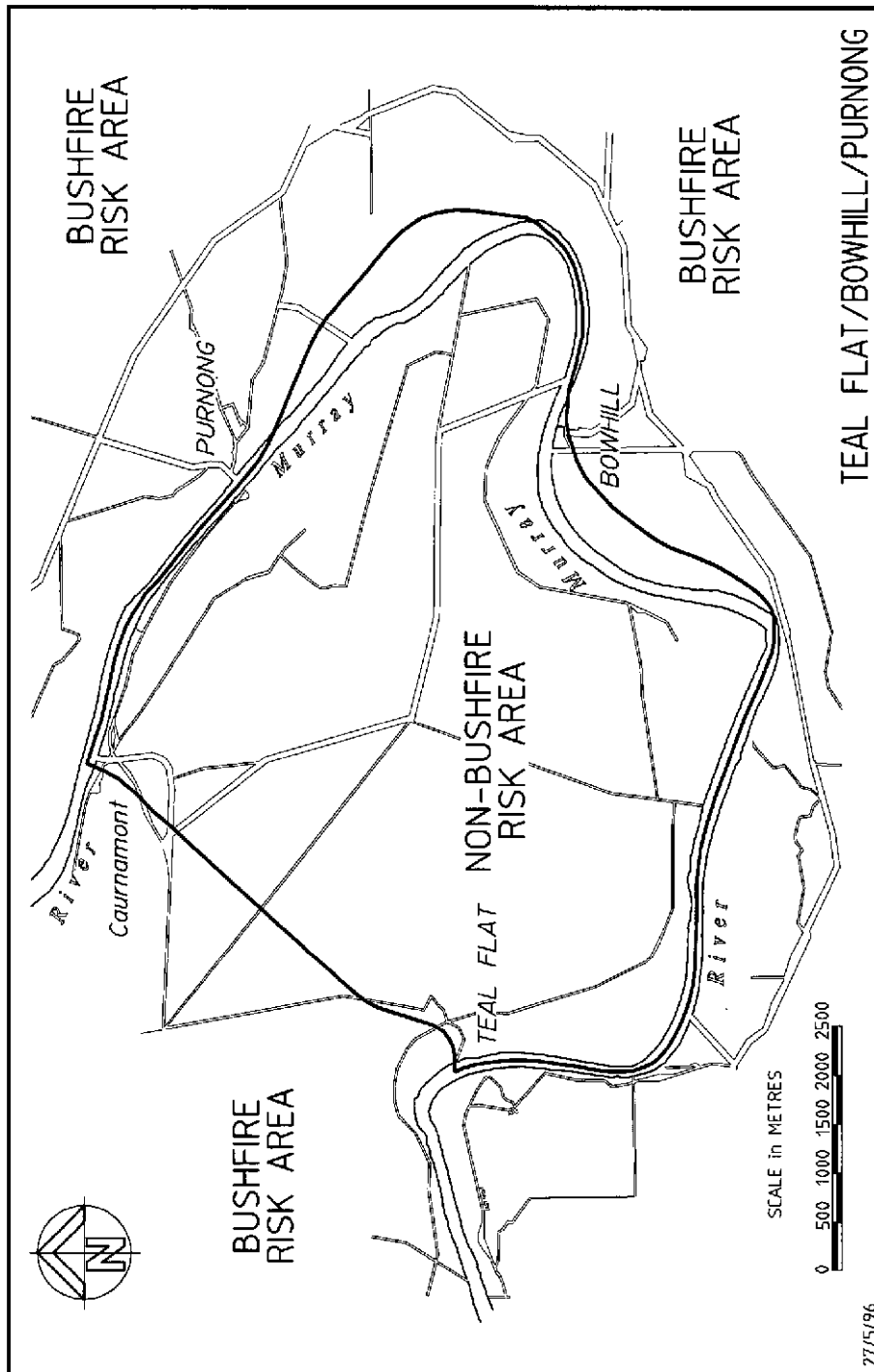

27/5/96

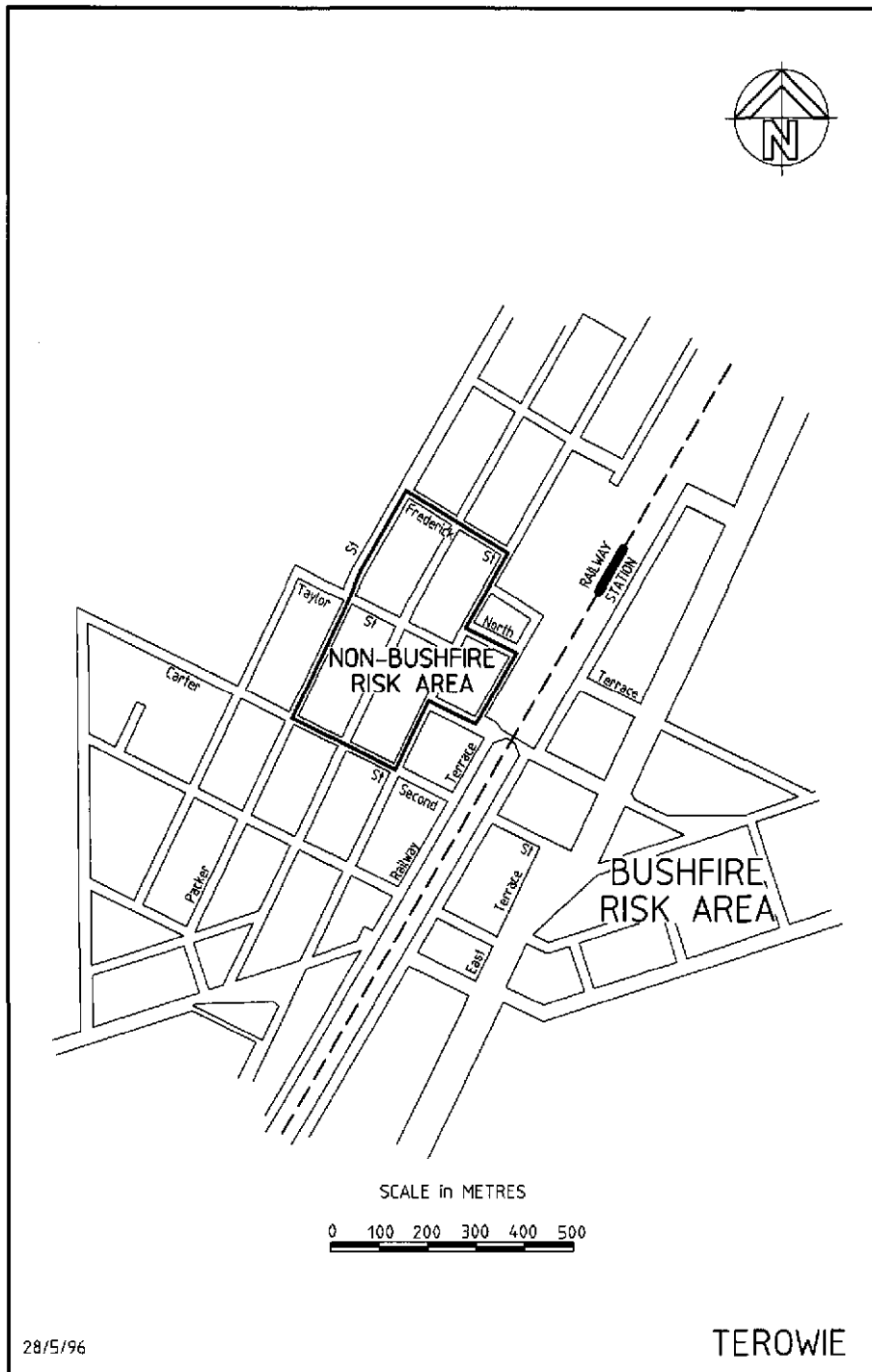

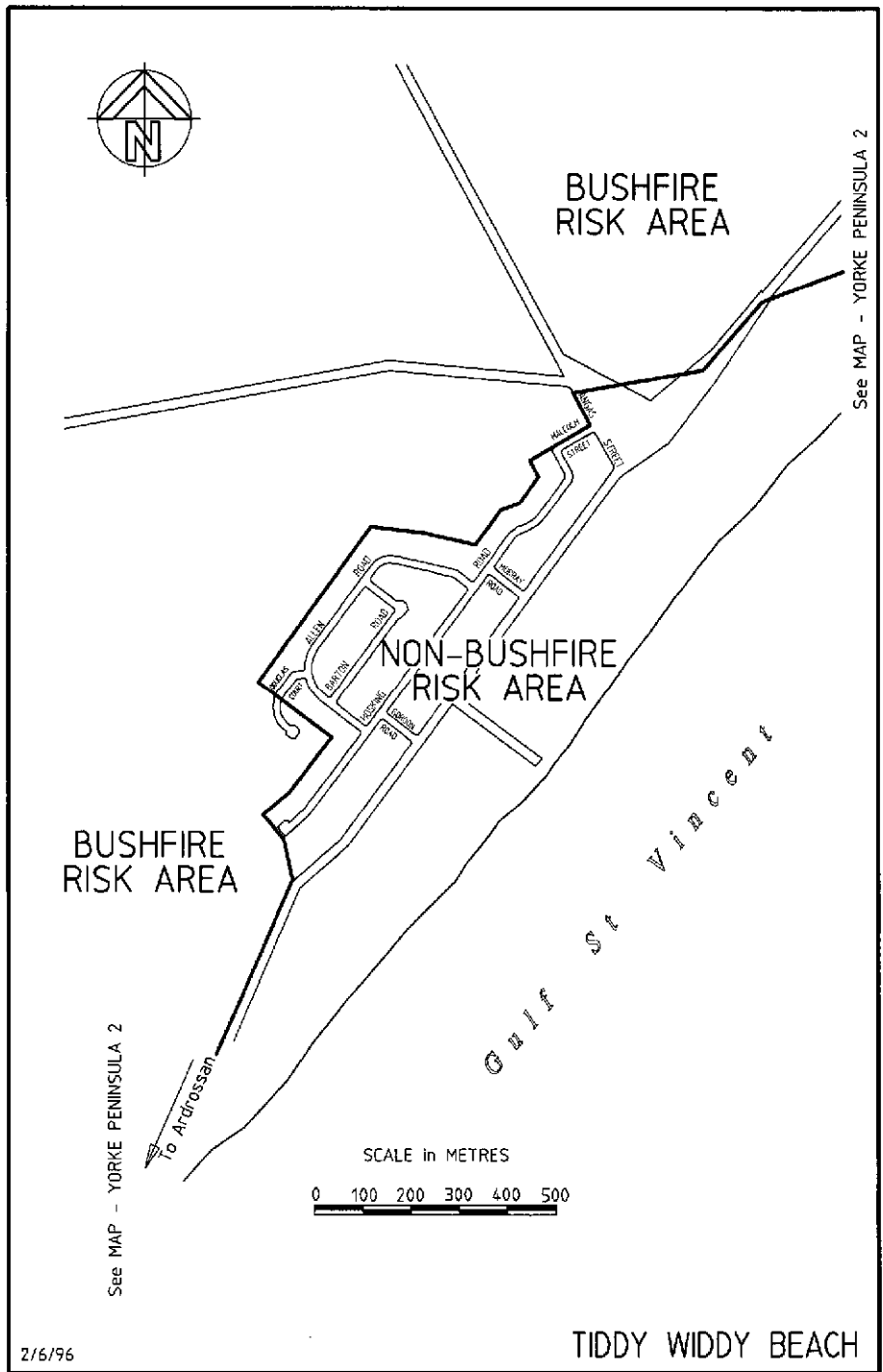

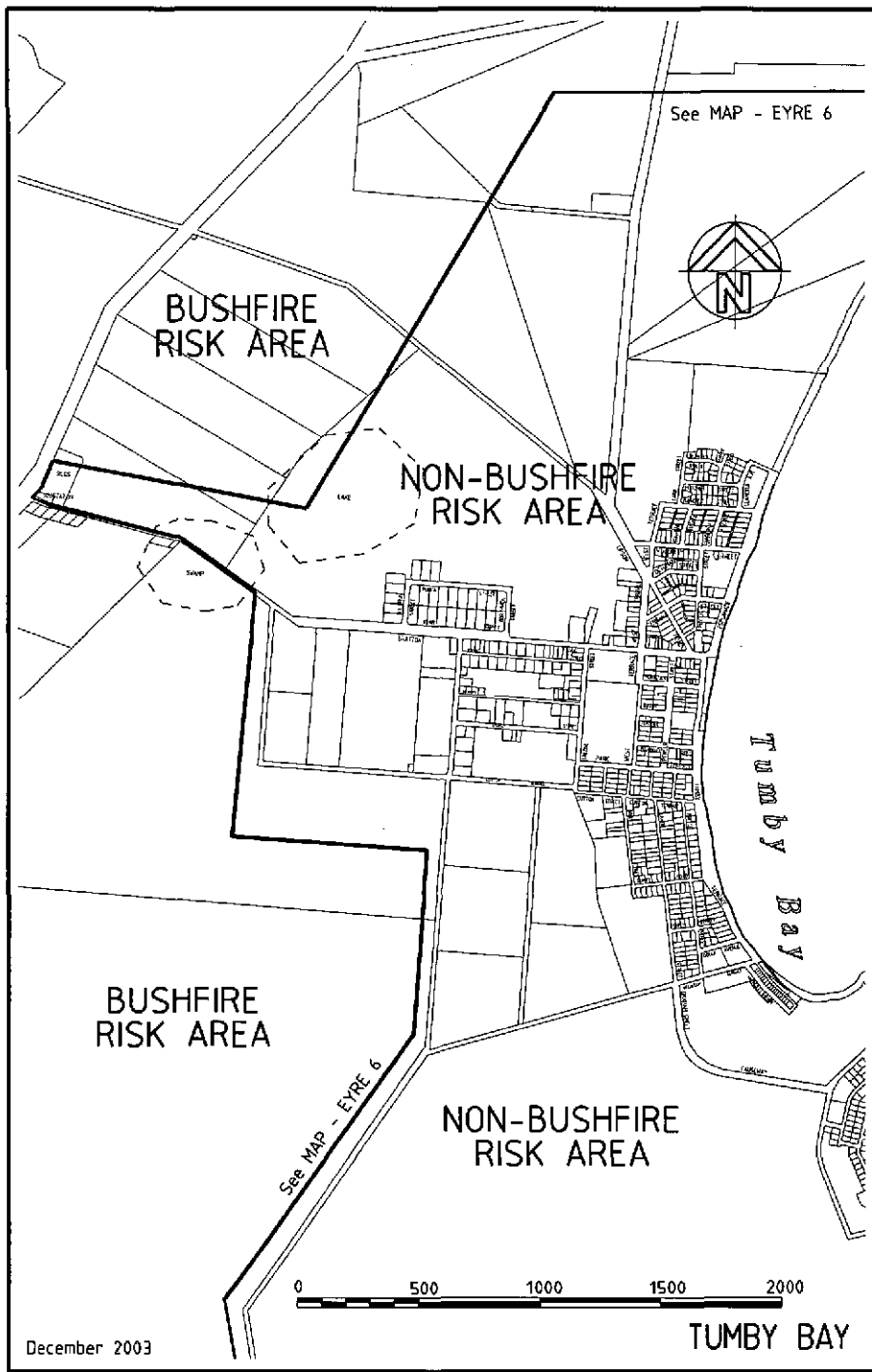

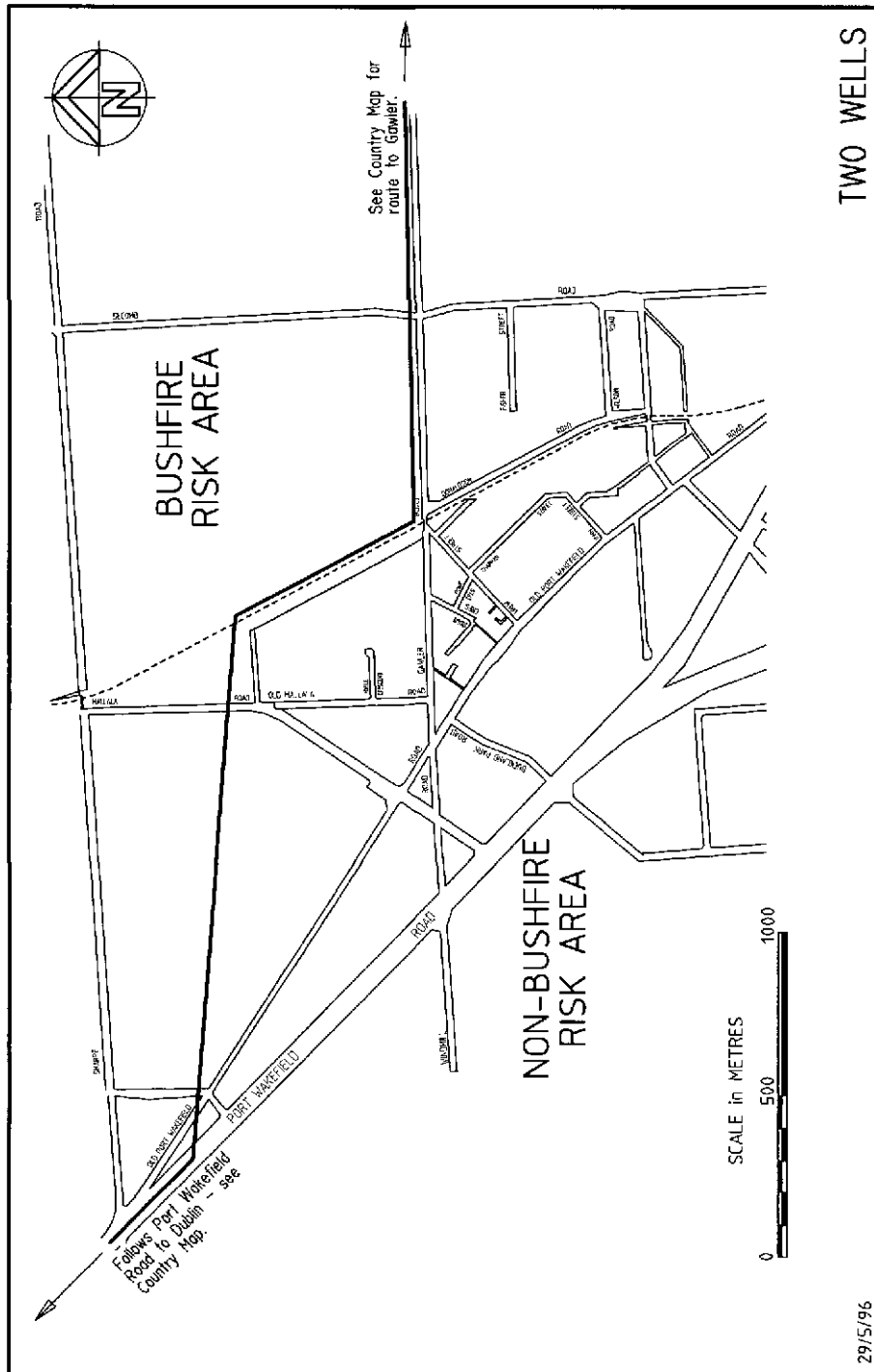

29/5/96

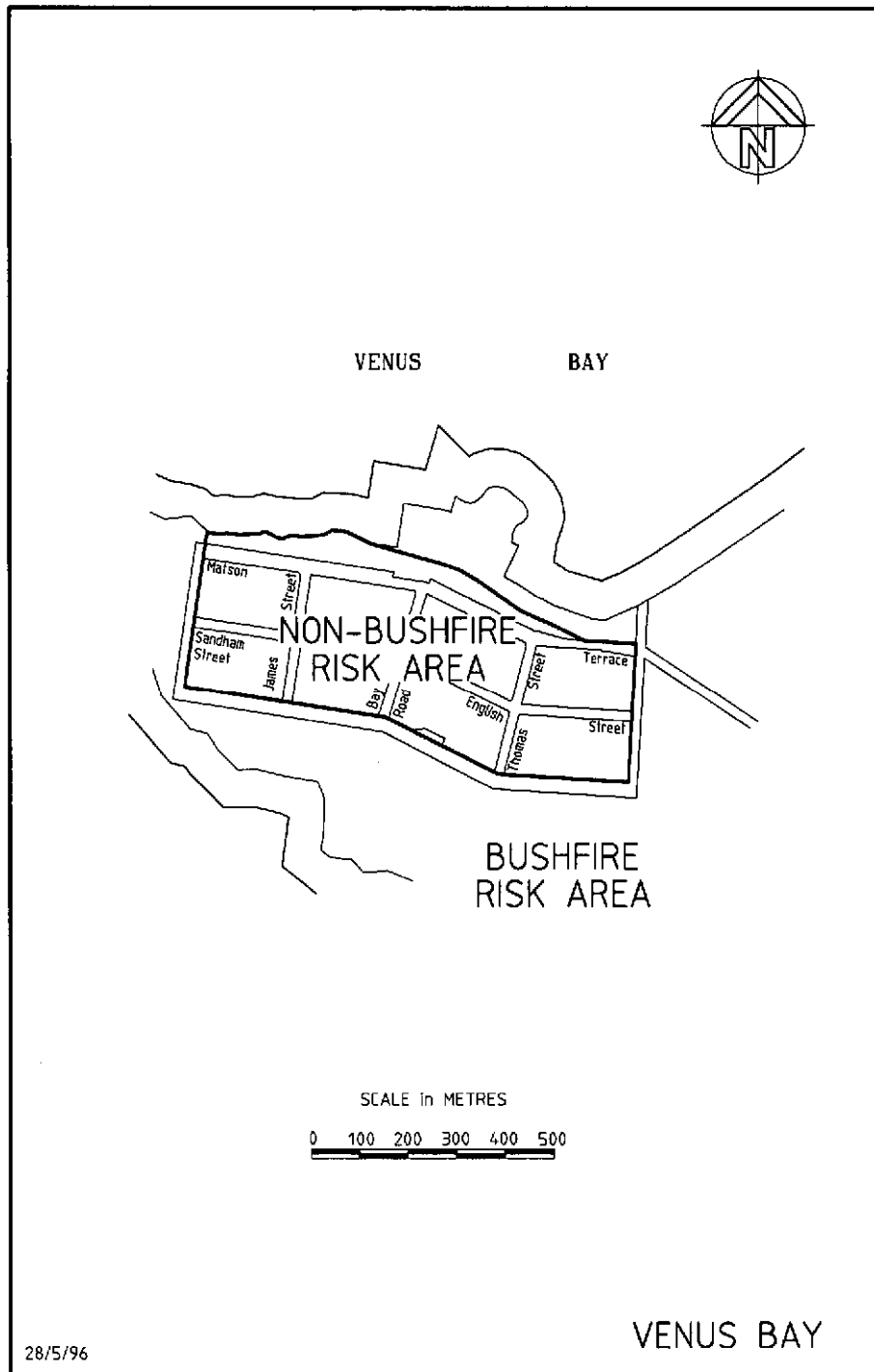

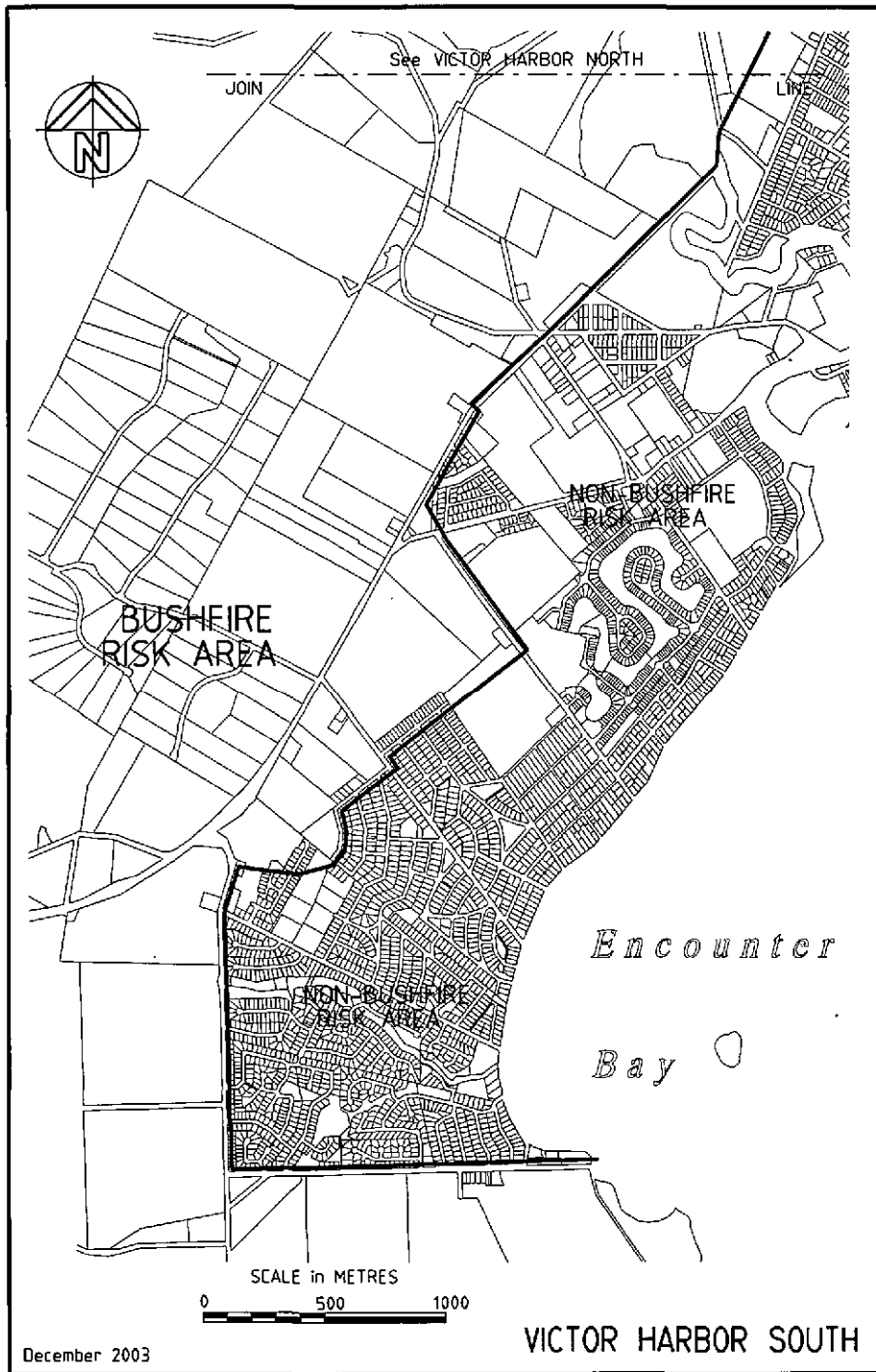

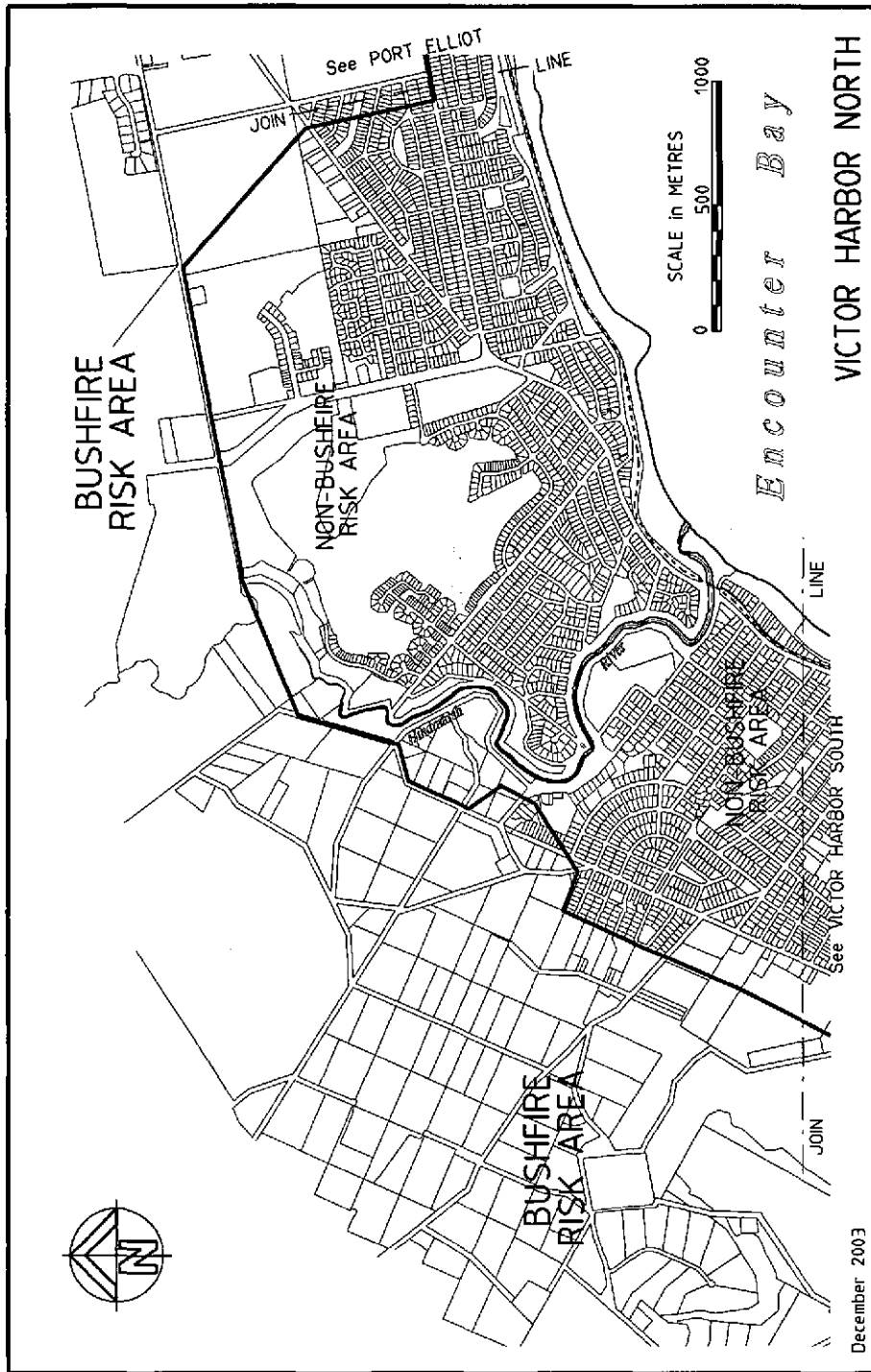

December 2003

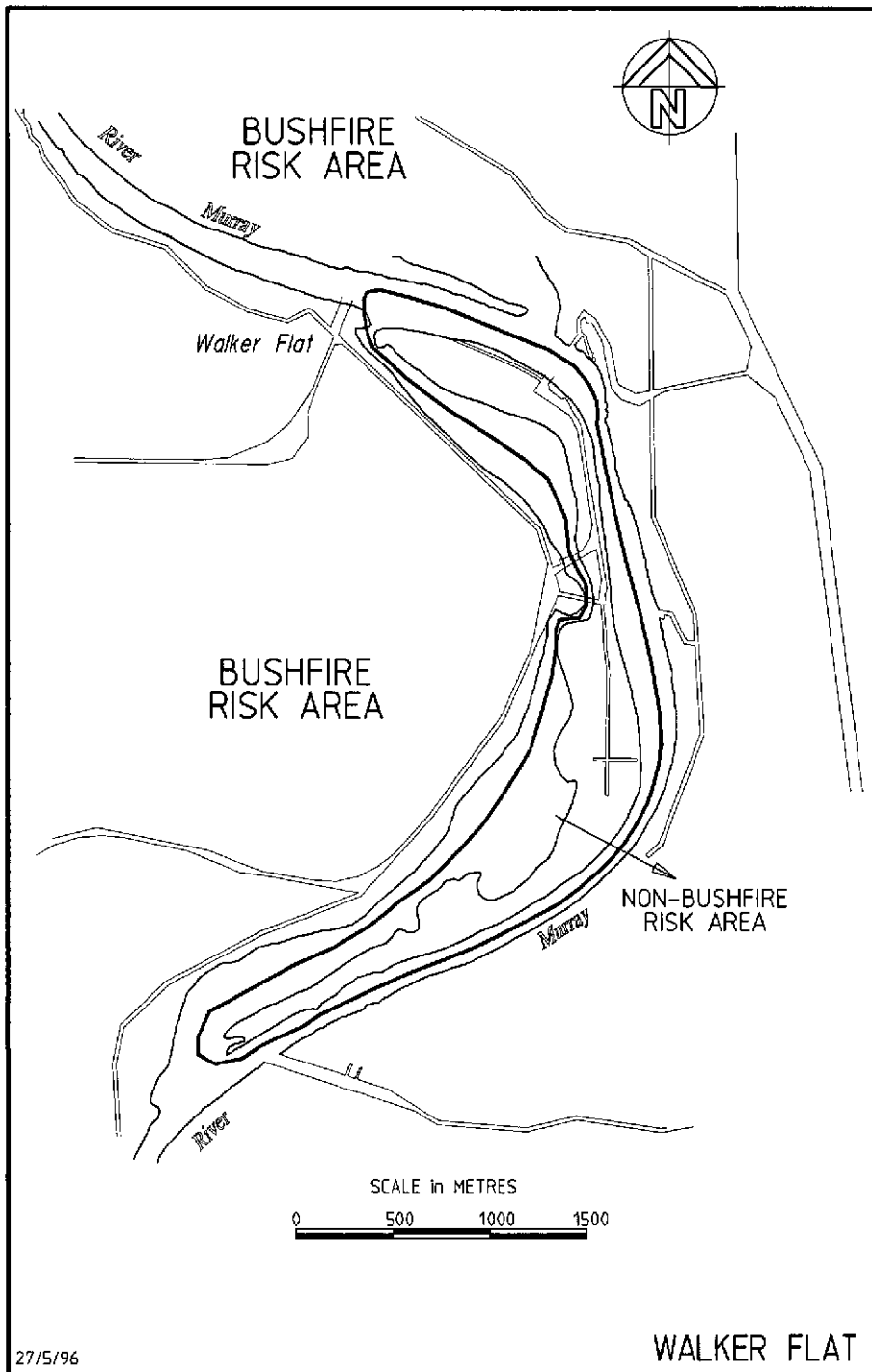

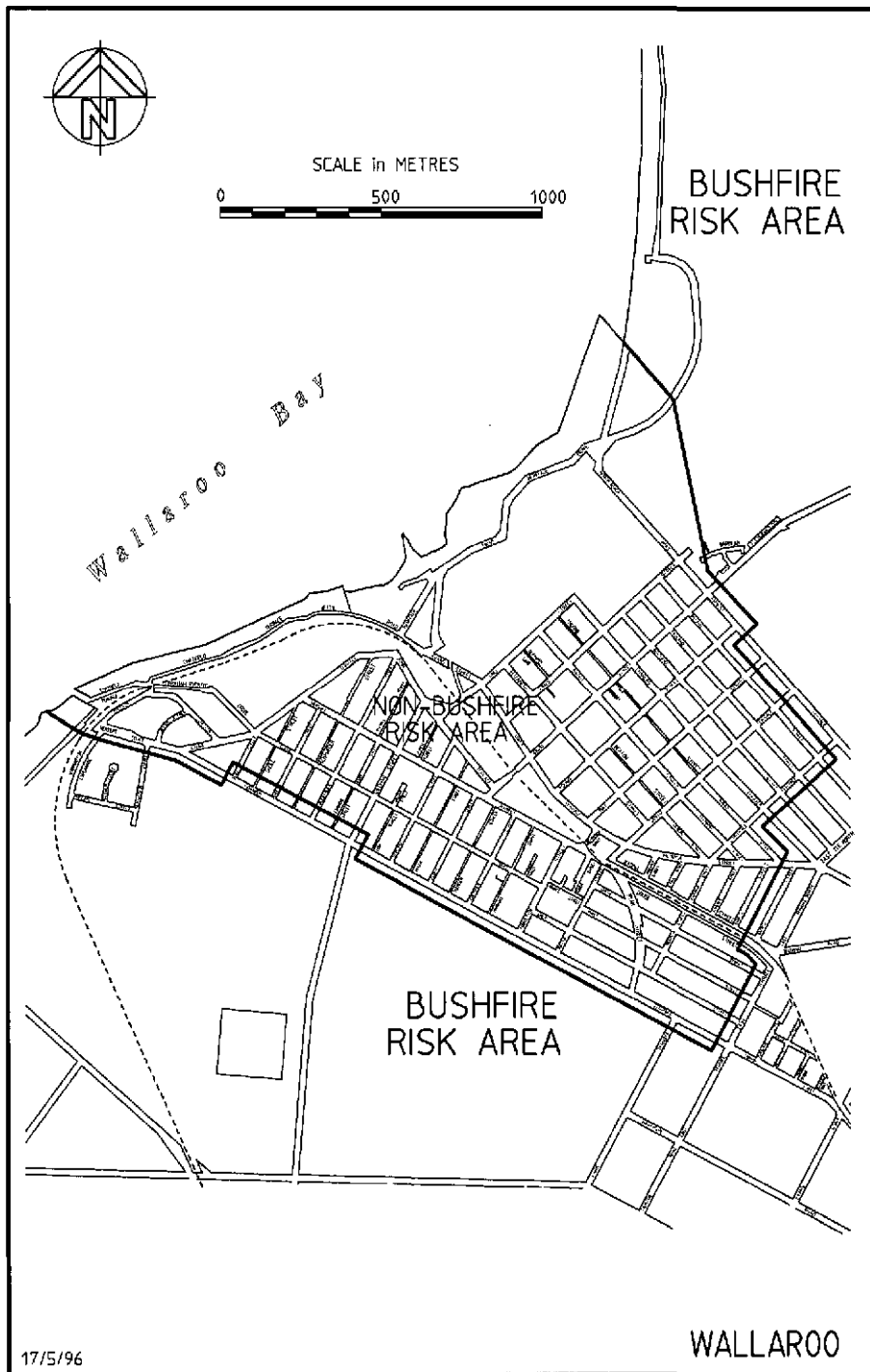

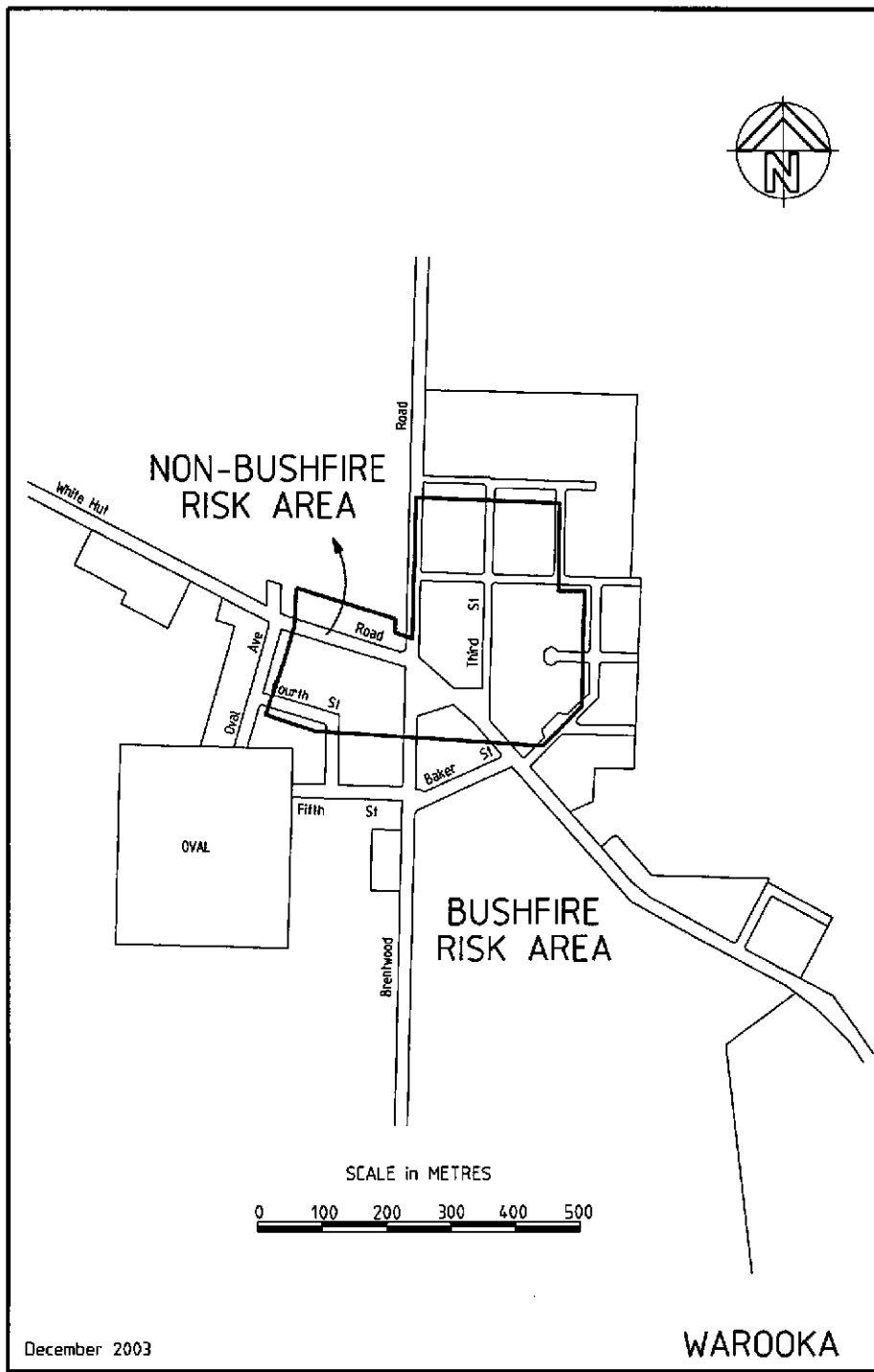

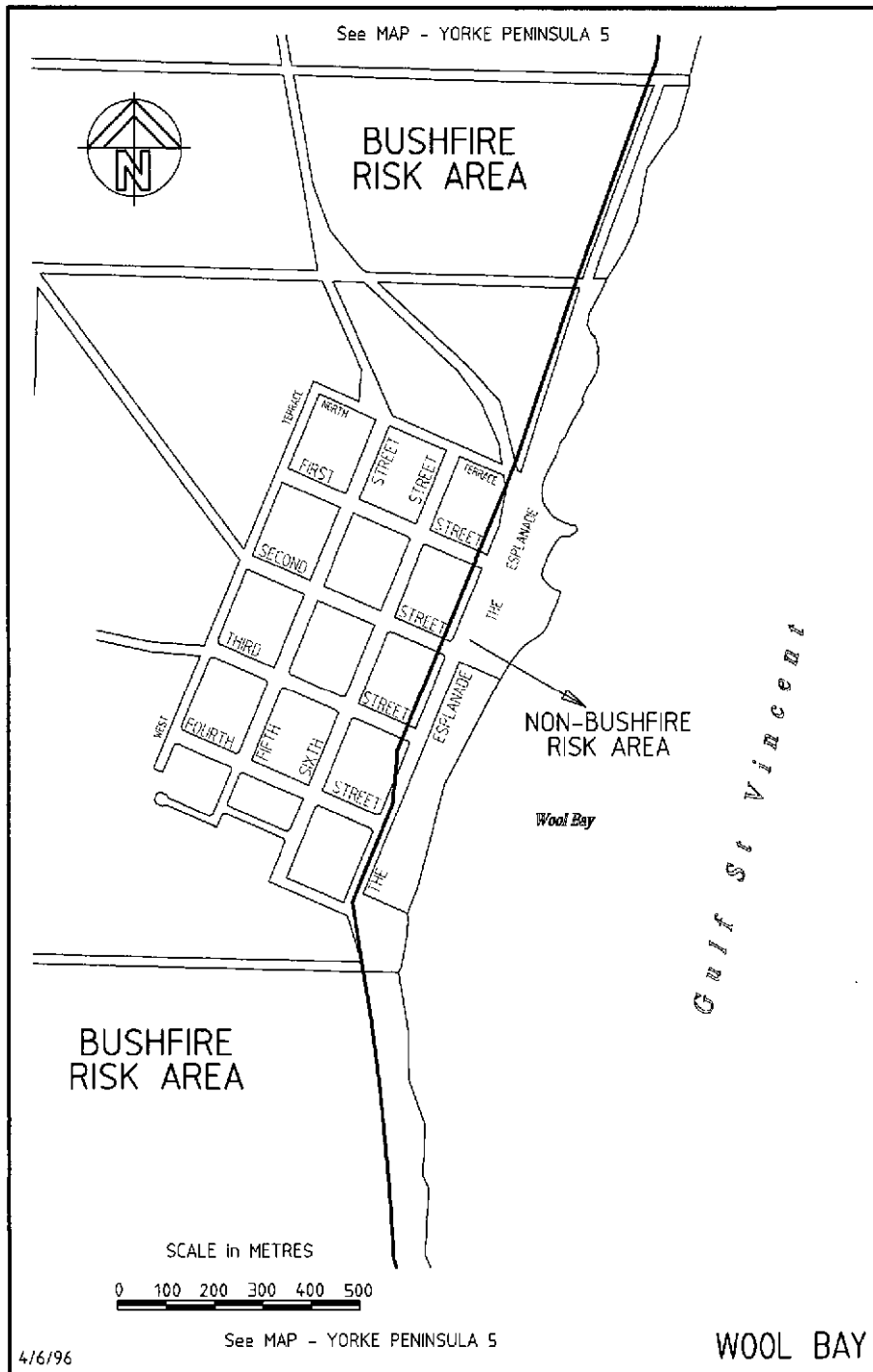

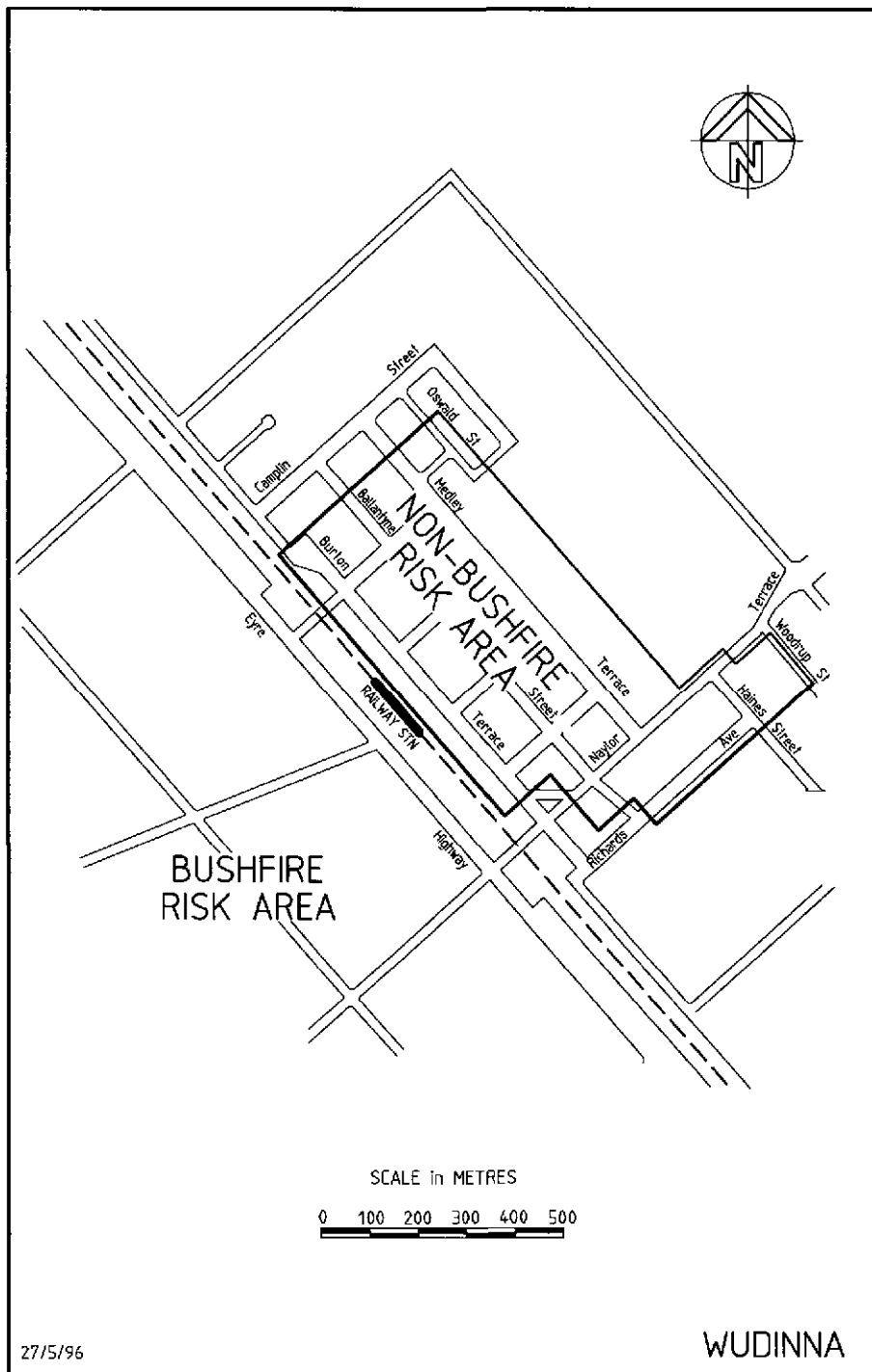

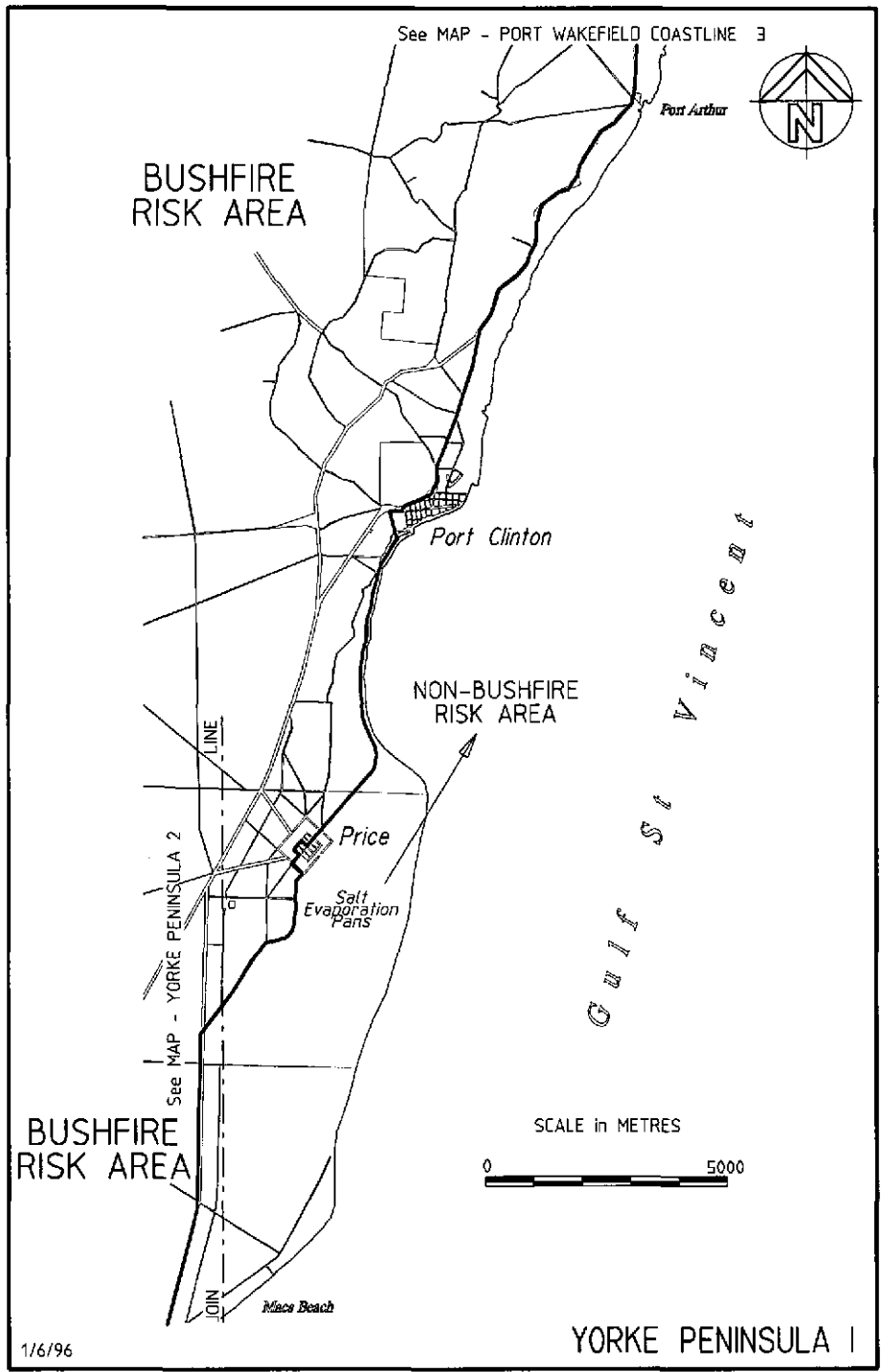

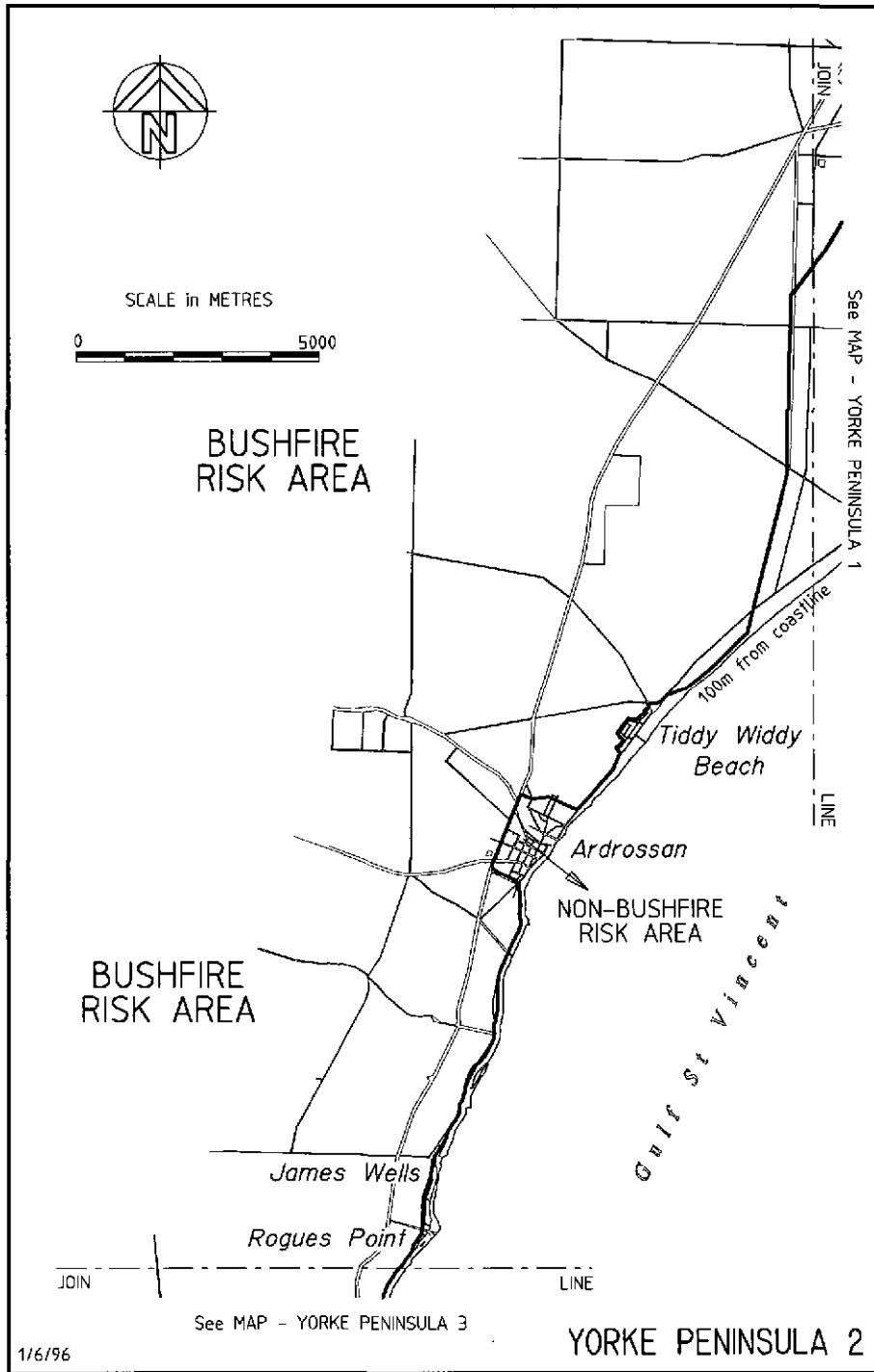

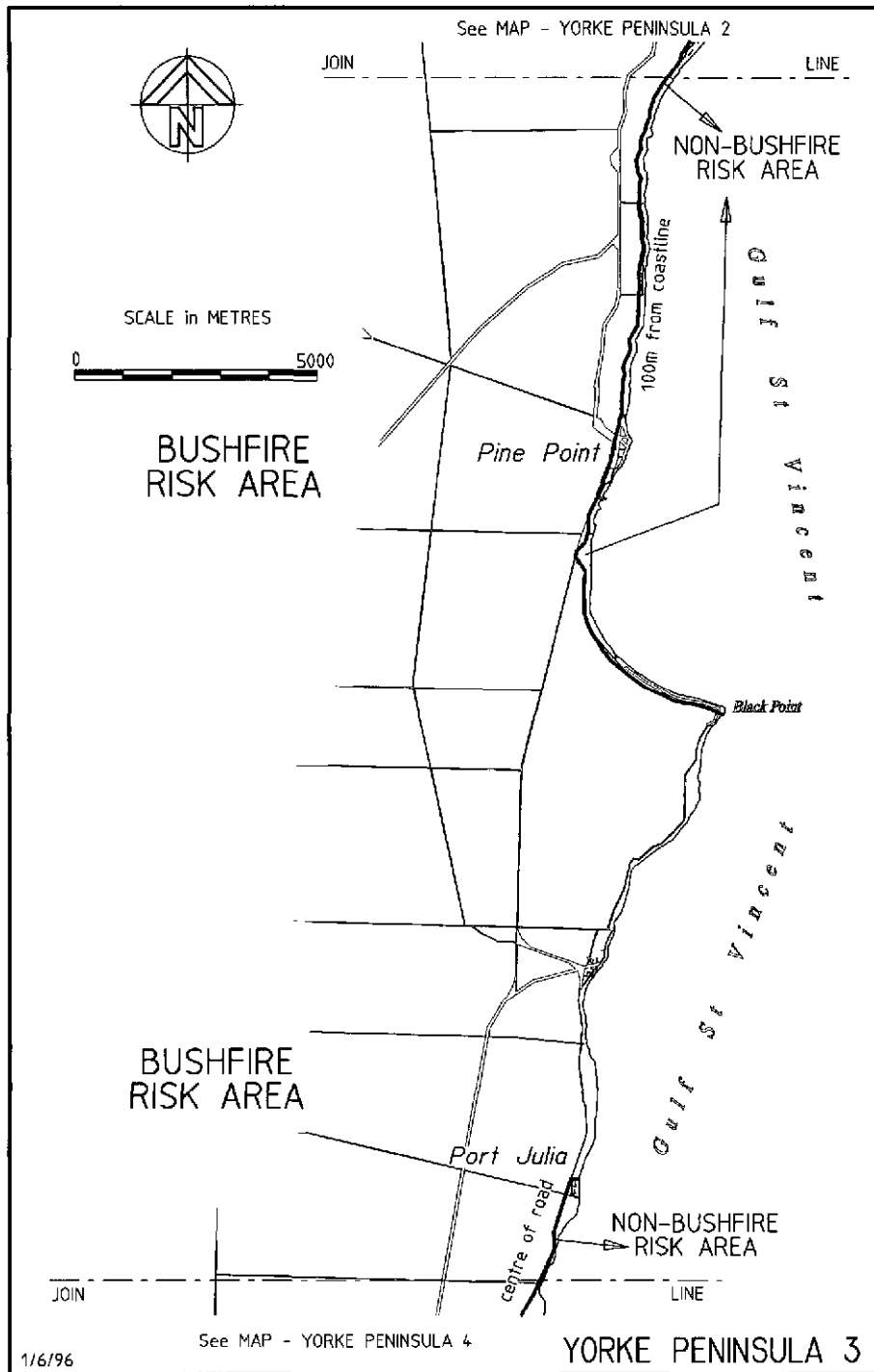

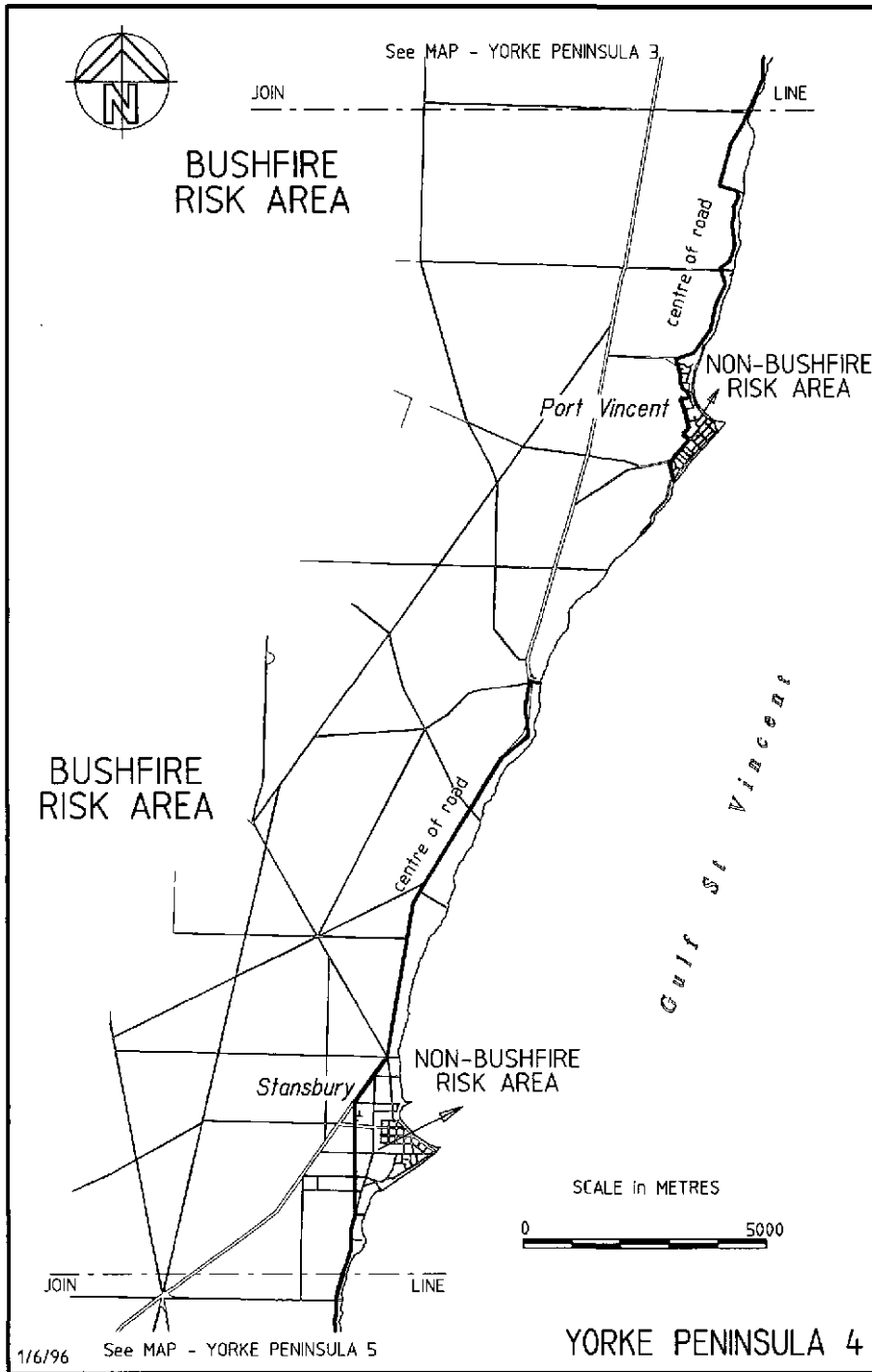

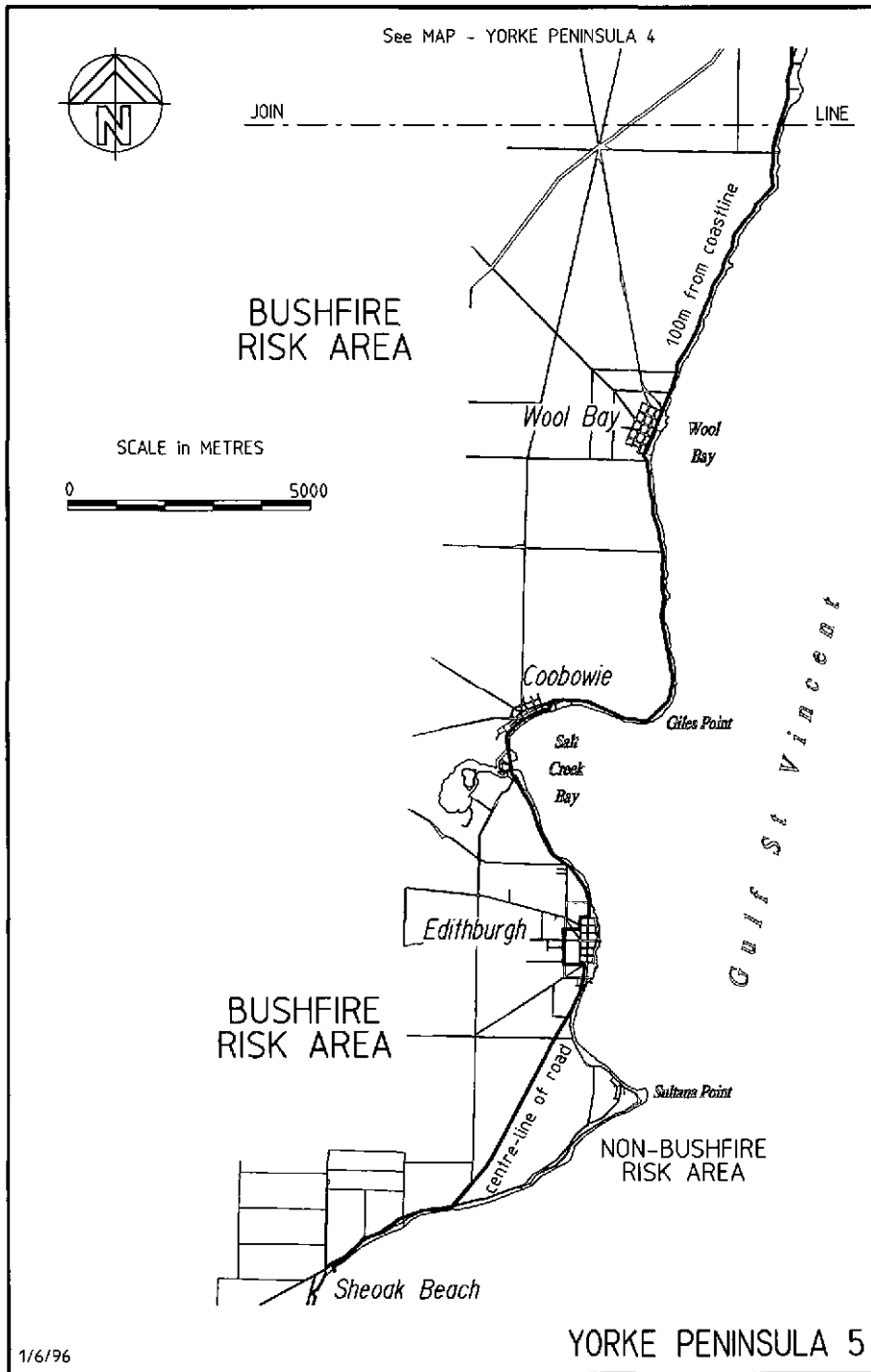

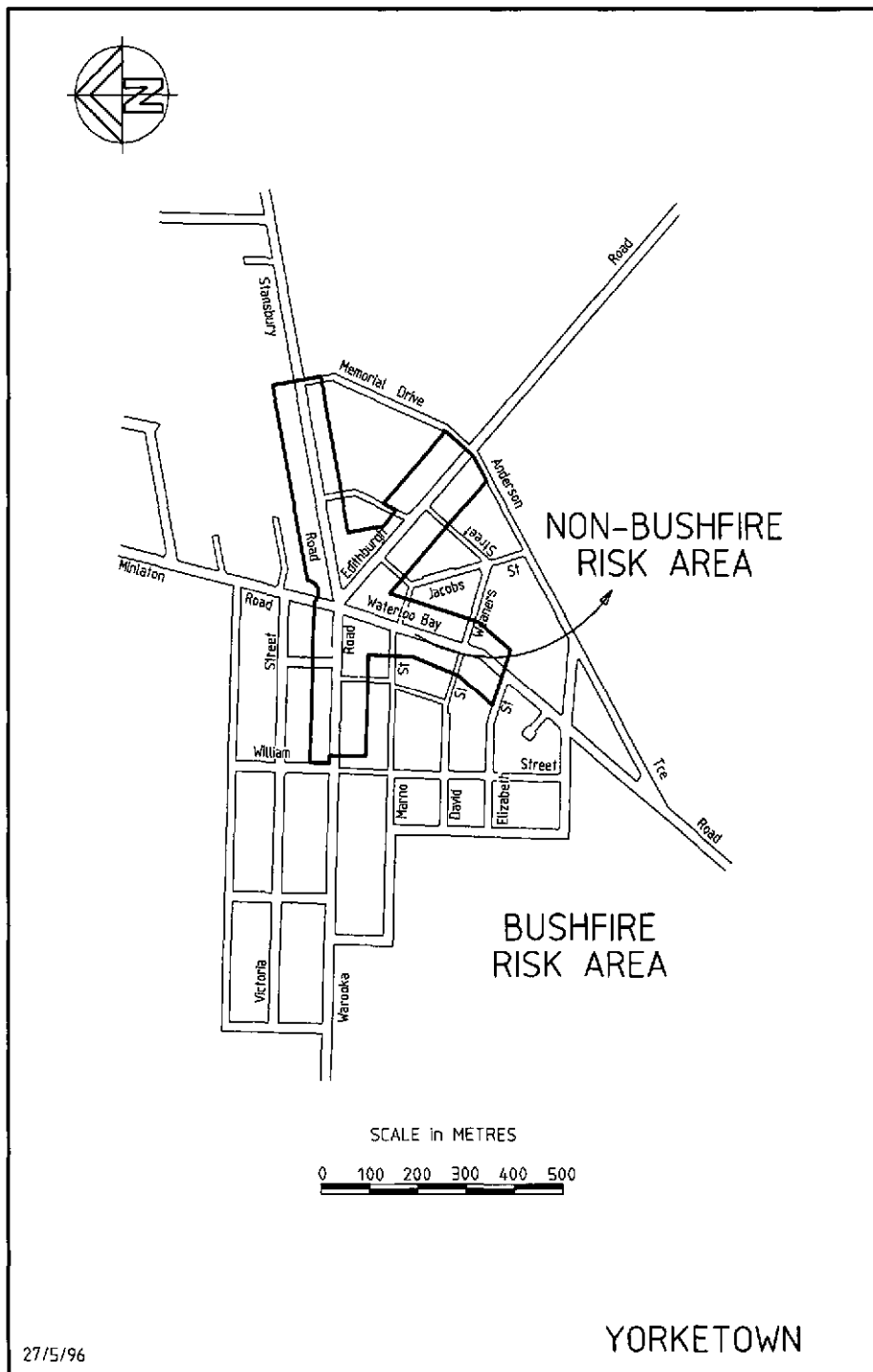

Schedule 5—Revocation and transitional provisions

Part 1—Revocation

1—Revocation of *Electricity (Principles of Vegetation Clearance) Regulations 1996*

The *Electricity (Principles of Vegetation Clearance) Regulations 1996* are revoked.

Part 2—Transitional provisions

2—Interpretation

In this Part—

revoked regulations means the *Electricity (Principles of Vegetation Clearance) Regulations 1996*.

3—Agreements with occupiers

An agreement under regulation 6 of the revoked regulations in force immediately before the commencement of this Schedule will be taken to be an agreement under regulation 9.

4—Vegetation clearance schemes with councils

A vegetation clearance scheme agreed under regulation 7 of the revoked regulations in force immediately before the commencement of this Schedule will be taken to be a vegetation clearance scheme agreed under regulation 8.

5—Exemptions

An exemption under regulation 11 of the revoked regulations in force immediately before the commencement of this Schedule will be taken to be an exemption under regulation 7.

Note—

As required by section 10AA(2) of the *Subordinate Legislation Act 1978*, the Minister has certified that, in the Minister's opinion, it is necessary or appropriate that these regulations come into operation as set out in these regulations.

Made by the Governor

after consulting with the Minister responsible for the administration of the *Environment Protection Act 1993* and with the advice and consent of the Executive Council
on 4 February 2010

No 12 of 2010

MEN08/016

South Australia

Anangu Pitjantjatjara Yankunytjatjara Land Rights Regulations 2010

under the *Anangu Pitjantjatjara Yankunytjatjara Land Rights Act 1981*

Contents

- | | |
|---|----------------|
| 1 | Short title |
| 2 | Commencement |
| 3 | Interpretation |
| 4 | By-laws |
-

1—Short title

These regulations may be cited as the *Anangu Pitjantjatjara Yankunytjatjara Land Rights Regulations 2010*.

2—Commencement

These regulations come into operation on the day on which they are made.

3—Interpretation

In these regulations—

Act means the *Anangu Pitjantjatjara Yankunytjatjara Land Rights Act 1981*.

4—By-laws

- (1) For the purposes of section 43(3)(f) of the Act, Anangu Pitjantjatjara Yankunytjatjara may make by-laws granting permission to specified persons, or specified classes of persons, to enter and remain on the lands.
- (2) Without limiting a provision of these regulations or the Act, a by-law made pursuant to subregulation (1) may—
 - (a) operate subject to specified conditions; and
 - (b) refer to or incorporate, wholly or partially and with or without modification, a code, standard or other document prepared or published by an authority or body, either as in force at the time the by-law is made or as in force from time to time; and
 - (c) make different provision according to the persons, things or circumstances to which it is expressed to apply; and
 - (d) provide that a matter or thing is to be determined, dispensed with, regulated or prohibited according to the discretion of Anangu Pitjantjatjara Yankunytjatjara, a specified person, authority or body, or a person holding a specified office.
- (3) If—
 - (a) a code, standard or other document is adopted by a by-law; or
 - (b) a by-law, or a code, standard or document adopted by a by-law, refers to a code, standard or other document prepared or published by an authority or body,

then—

- (c) a copy of the code, standard or other document must be kept available for inspection by members of the public, without charge and during normal office hours, at—
 - (i) the principal office of Anangu Pitjantjatjara Yankunytjatjara; and
 - (ii) the Minister's office; and
- (d) in any legal proceedings, evidence of the contents of the code, standard or other document may be given by production of a document purporting to be certified by or on behalf of Anangu Pitjantjatjara Yankunytjatjara as a true copy of the code, standard or other document; and
- (e) the code, standard or other document has effect as if it were a by-law made under the Act.

Note—

As required by section 10AA(2) of the *Subordinate Legislation Act 1978*, the Minister has certified that, in the Minister's opinion, it is necessary or appropriate that these regulations come into operation as set out in these regulations.

Made by the Governor

with the advice and consent of the Executive Council
on 4 February 2010

No 13 of 2010

AACS10/0004

FAXING COPY?

IF you fax copy to **Government Publishing SA** for inclusion in the *Government Gazette*, there is **no need** to send a Confirmation Copy to us as well.

This creates confusion and may well result in your notice being printed **twice**.

Please use the following fax number:

Fax transmission: (08) 8207 1040
Phone Inquiries: (08) 8207 1045

Please include a contact person, phone number and order number so that we can phone back with any queries we may have regarding the fax copy.

NOTE: Closing time for lodging new copy (fax, hard copy or email) is 4 p.m. on Tuesday preceding the day of publication.

Government Gazette notices can be E-mailed.

The address is:

governmentgazette@dpc.sa.gov.au

Documents should be sent as attachments in Word format.

When sending a document via E-mail, please confirm your transmission with a faxed copy of your document, including the date the notice is to be published.

Fax transmission: (08) 8207 1040
Enquiries: (08) 8207 1045

NOTE: Closing time for lodging new copy (fax, hard copy or email) is 4 p.m. on Tuesday preceding the day of publication.

CITY OF TEA TREE GULLY

Change of Street Name

NOTICE is hereby given that the Council of the City of Tea Tree Gully, at its meeting held on 19 January 2010, resolved that, pursuant to section 219 (1) of the Local Government Act 1999, the street known as Ray Street, Gilles Plains be changed to Gay Avenue, Gilles Plains.

A plan which delineates the street which is subject to the change of name, together with a copy of the Council's resolution, is available for inspection at the Council's Civic Centre, 571 Montague Road, Modbury, S.A. 5092 during the hours of 8.45 a.m. and 5 p.m. on weekdays.

D. ROGOWSKI, Chief Executive Officer

DISTRICT COUNCIL OF ROBE

Naming of Roads

NOTICE is hereby given, pursuant to section 219 (4) of the Local Government Act 1999, that the District Council of Robe resolved pursuant to section 219 (1) of the Local Government Act 1999, at its meeting held on Tuesday, 12 January 2010 to assign the names to the public roads described in the table below:

Road Name	From	To
Ackson Park Road	Robe Clay Wells Road (DTEI)	Legoes Road—Wattle Range Council Boundary Road
Ballentyne Road	Robe Clay Wells Highway (DTEI)	Property Section 32, Hd Bray
Ballentyne Road	Property Section 32, Hd Bray	Property Section 11, Hd Bray
Bowyers Way Road	Springs Road	Property Section 123, Hd Bray
Chinamans Lane	Robe—Clay Wells Road (DTEI)	Property Section 172, Hd Smith
Cortina Road	Woodleigh Lane Road	Jorgensons Road
Dawsons Lane	Robe Clay Wells Road (DTEI)	Lake Hawdon Road
Drabsch Hd Line Road (Kingston District Council—Boundary Road)	Baxters Hill Road	Ross Quarry Road
Engelhart Lane	Southern Ports Highway (DTEI)	Property Section 250, Hd Waterhouse
Evans Cave Road	Robe Street	Industrial Estate Water Retention Basin
Evans Cave Road	Industrial Estate Water Retention Basin	Landfill Entrance Gate
Flints Road	Murra Up Road	Kingston District Council
Fletchers Lane	McGuinness Road	Property Section 581, Hd Waterhouse
Frog Island Road	Lake Hawdon Road	Princes Highway (DTEI)
George Ormerod Drive	Wildfield Road	Property Lot 100, DP 75615, Hd Waterhouse
Douglas Dawson Track	Robe Street, End of Bitumen	Property Section 16, Hd Waterhouse
Hermitage Road	Nora Creina Road	Property Section 16, Hd Waterhouse
Higgins Road	Loxtons Road	Naracoorte Lucindale Council [Boundary Road]

Road Name	From	To
Jerusalems Hut Road	Baxters Hill Road	Property Section 118, Hd Waterhouse
Legoes Road (Wattle Range Council—Boundary Road)	Southern Ports Hwy (DTEI)	Wattle Range Council—Magarey's Road
Lings Road	Boatswain Point Road	Kingston District Council
McGuinness Road	Wright Bay Road	Fields Road (Kingston District Council)
Longbottom Lane	Lings Road	Property Section 486, Hd Waterhouse
Lou's Lane	Lake Hawdon Road	Property Section 44, Hd Bray
Loxtons Road	Konetta Naracoorte Road (DTEI)	Higgins Road (Naracoorte Lucindale Council Boundary Road)
McEwens Lane	Cowans Road	Property Section 18, Hd Ross
McEwens Lane	Princes Highway (DTEI)	Property Section 16, Hd Ross
Murra Up Road	Bagdad Road	Kingston District Council Boundary
Nunga-Mia Road	Sandy Lane	Property Section 439, Hd Waterhouse
Pearson Street (Greenways) Bitumen Sealed	Konetta Naracoorte Road (DTEI)	Residential Houses
Pearson Street (Greenways)	Residential Houses	Property Section 132, Hd Smith
Powells Road	Bog Lane	Southern Ports Highway (DTEI)
Sargents Hill Road	Long Island Road	Property Section 407, Hd Waterhouse
Sneath Road	Boatswain Point Road	Property Section 479, Hd Waterhouse
Sneyd Island Road	Robe Clay Wells Highway (DTEI)	Wattle Range Council [Boundary]
Stone Reserve Road	Robe—Clay Wells Road (DTEI)	Property Section 149, Hd Smith
Tea Tree Swamp	Barnett Swamp Road	Property Section 120, Hd Ross
Tuckers Lane	Wattle Range Council (Boundary)	Property Section 14, Hd Smith
Vearing Road	Southern Ports Highway (DTEI)	Property Section 204, Hd Waterhouse
West Avenue South Road	Konetta Naracoorte Road (DTEI)	Property Section 96, Hd Smith
Wildfield Road	Southern Ports Highway (DTEI)	Nora Creina Road
Wright Bay Road	Southern Ports Highway (DTEI)	Property Section 259, Hd Waterhouse
Boyong Road	Dairy Range Road	Property Section 178, Hd Smith
Tonkin Road	Sandy Lane	Along Property Section Pts 207, Hd Waterhouse

Ross Quarry Road be renamed to Cossacks Water Hole Road from Dairy Range Road to Drabsch Hd Line Road.

Road located off Southern Ports Highway along property Sections 198 and 199, Hundred of Waterhouse be renamed from Long Beach Road to Steve Woolston Road.

B. HENDER, Chief Executive Officer

DISTRICT COUNCIL OF ROBE

ROADS (OPENING AND CLOSING) ACT 1991

*Old Naracoorte Road, adjacent to Spots Hill Bridge—
Reedy Creek*

NOTICE is hereby given, pursuant to section 10 of the said Act, that the Council proposes to make a Road Process Order to open as road portion of Section 119 forming a road re-alignment, as shown numbered '1' on Preliminary Plan No. 10/0003 and to close and exchange with R. G. Ogilvie the portion of Old Naracoorte Road rendered superfluous by the new road, that portion shown as 'A' and to close and vest in the Crown that portion shown as 'B' on Preliminary Plan No. 10/0003:

A copy of the plan and statement of persons affected are available for public inspection at Council's Office, Royal Circus, Robe, S.A. 5276 and the office of the Surveyor-General, 101 Grenfell Street, Adelaide, S.A. 5000 during normal office hours.

Any application for easement or objections must be made in writing within 28 days from 4 February 2010 to the Council, P.O. Box 1, Robe, S.A. 5276 and the Surveyor-General, G.P.O. Box 1354, Adelaide, S.A. 5001, setting out full details. Where a submission is made, Council will give notification of a meeting to deal with the matter.

B. HENDER, Chief Executive Officer

IN the matter of the estates of the undermentioned deceased persons:

Creaser, Helen Sonia, late of 44A Skyline Drive, Flagstaff Hill, of no occupation, who died on 5 December 2009.

Dixon, Brian John, late of 1A Mount Barker Road, Hahndorf, retired plumber, who died on 15 August 2009.

Glover, Catriona Nicholson Stewart, late of 30 Sussex Terrace, Westbourne Park, of no occupation, who died on 1 December 2009.

Grimwood, George, late of 51 Eighth Avenue, St Peters, of no occupation, who died on 6 January 2008.

Harnas, Herman, late of 254-266 Greenhill Road, Glenside, retired business proprietor, who died on 2 December 2008.

Kasper, Janet Gilmour, late of 410 Henley Beach Road, Lockleys, of no occupation, who died on 6 December 2009.

Knight, John Stephen, late of 33 Bains Road, Morphett Vale, retired plumber, who died on 16 September 2009.

Magain, Alwyn Roy, late of 25 Freeling Crescent, Colonel Light Gardens, retired toolmaker, who died on 16 November 2009.

McMahon, Joyce Anne Alice, late of 150 Reynell Road, Woodcroft, widow, who died on 15 November 2009.

Miller, Joseph Brendan, late of 31 Stradbroke Road, Athelstone, retired engineer, who died on 15 November 2009.

Noble, Mavis, late of 580 Brighton Road, South Brighton, of no occupation, who died on 14 September 2009.

Shaw, Florence Alwine, late of 4 Mattson Avenue, Warradale, widow, who died on 22 December 2009.

Vagner, Evelyn Louise, late of 14 Fraw Street, Fullarton, of no occupation, who died on 17 December 2009.

Woodrow, Constance Violet, late of 7 Bruan Drive, Hahndorf, of no occupation, who died on 28 November 2009.

Notice is hereby given pursuant to the Trustee Act 1936, the Inheritance (Family Provision) Act 1972 and the Family Relationships Act 1975, that all creditors, beneficiaries, and other persons having claims against the said estates are required to send, in writing, to the Public Trustee, 25 Franklin Street, Adelaide, S.A. 5000, full particulars and proof of such claims, on or before 5 March 2010, otherwise they will be excluded from the distribution of the said estate; and notice is also hereby given that all persons who are indebted to the said estates are required to pay the amount of their debts to the Public Trustee or proceedings will be taken for the recovery thereof; and all persons having any property belonging to the said estates are forthwith to deliver the same to the Public Trustee.

Dated 4 February 2010.

M. I. BODYCOAT, Public Trustee

PARTNERSHIP ACT 1891-1975

Notice of Discontinuance of Partnership

TAKE notice that as from Wednesday, 27 January 2010 the partnership of Kelly Steen, 10 Lafayette Drive, Port Lincoln, S.A. 5606, Annette Sherry, 10 Lafayette Drive, Port Lincoln, S.A. 5606 and Jacqueline Wegener, 5 Woolga Street, Port Lincoln, S.A. 5606 who traded as Wisteria Lane was dissolved.

Kelly Steen has retired from the partnership.

Annette Sherry and Jacqueline Wegener will continue to operate the business under the name of Wisteria Lane and shall be responsible for all the debts and liabilities thereof.

Dated 27 January 2010.

K. STEEN

A. SHERRY

J. WEGENER

UNCLAIMED MONEYS ACT 1891

Register of Unclaimed Moneys Held by Bridgestone Australia Ltd as at January 2002

Name and Address of Owner on Books	Total Amount Due to Owner \$	Dividend Payment	Date
Dorothy Lucille Beil, P.O. Box 202, Mooloolaba, Qld 4557	191.40	Dividend	30.4.02
Dr Ralph Howard Craven and Lesley Clare Craven, P.O. Box 393, Indooroopilly, Qld 4068	75.00	Dividend	30.4.02
Peter John Cruise and Brenton Phillip Lynch, 268 Coombe Street, Nangwarry, S.A. 5277	75.00	Dividend	30.4.02
Alan Gordon Bennett (deceased estate), c/o S. Bennett, 68 Eldorado Street, Tuart Hill, W.A. 6060	13.13	Dividend	30.4.02
Alexandra Anne Michell, 52 Seaview Terrace, Sunshine Beach, Qld 4567	349.50	Dividend	30.4.02
P. G. Bendixen Medical Pty Ltd, <Bendixen Medical P/L S/F>, 5 Kidston Street, Albion, Qld 4010	300.00	Dividend	30.4.02
Catherine Elizabeth Prideaux, 15 Dynnyrne Road, Dynnyrne, Tas. 7005	150.00	Dividend	30.4.02
Dr Ramela Sunalini Rajakaruna, 63 Florence Road, Nedlands, W.A. 6009	75.00	Dividend	30.4.02
Jane Patricia Ridgley and Doreen Ridgley, 54 Wellington Crescent, Torquay, Qld 4655	22.50	Dividend	30.4.02
Margaret Smith (deceased estate), 1 Jervois Road, Semaphore South, S.A. 5019	20.18	Dividend	30.4.02
Virgil Gheroghe Strenc, 4 Bruxner Place, Doonside, N.S.W. 2767	30.00	Dividend	30.4.02
Allan Lawrence Trethewey, West Nombi, Mullaley via Gunnedah, N.S.W. 2380	750.00	Dividend	30.4.02
Robert Lesley Watkins and Ermindita Watkins, P.O. Box 537, Archerfield, Qld 4108	150.00	Dividend	30.4.02
C/o Edwards Marshall & Co., G.P.O. Box 2163, Adelaide, S.A. 5001	199.95	Dividend	30.4.02
Noriyuki Kawaguchi, 6353-26 Yamato Nishimuta, Chikugo-Shi, Fukuoka Prefecture, Japan	150.00	Dividend	30.4.02
William Wong, 6/66 Shackleton Road, Mount Eden, Auckland, New Zealand	75.00	Dividend	30.4.02
Leila M. Avery, P.O. Box 190, Mittagong, N.S.W. 2575	30.45	Dividend	30.4.02
Peter Belbin (deceased estate), c/o Austen Brown Thompson, P.O. Box 832, Dubbo, N.S.W. 2830	562.50	Dividend	30.4.02
April Joy Davey, c/o 15 Condada Avenue, Parkholme, S.A. 5043	22.50	Dividend	30.4.02
John O'Brien, 245 Lygon Street, East Brunswick, Vic. 3057	11.25	Dividend	30.4.02
Michela V. Skerbec, 10 Wright Street, Balmoral, Qld 4171	105.00	Dividend	30.4.02
John G. Wilson (deceased estate), c/o J. Wilson, 46 Kent Road, North Ryde, N.S.W. 2113	20.33	Dividend	30.4.02

UNCLAIMED MONEYS ACT 1891

Register of Unclaimed Moneys Held by Bridgestone Australia Ltd as at January 2003

Name and Address of Owner on Books	Total Amount Due to Owner \$	Dividend Payment	Date
Dorothy Lucille Beil, P.O. Box 202, Mooloolaba, Qld 4557	191.40	Dividend	30.4.02
S. & W. Marketing International Pty Ltd, 5 Dimora Court, Adelaide, S.A. 5000	10.00	Dividend	30.4.03
John O'Brien, 245 Lygon Street, East Brunswick, Vic. 3057	15.00	Dividend	30.4.03
Alan Gordon Bennett (deceased estate), c/o S. Bennett, 68 Eldorado Street, Tuart Hill, W.A. 6060	17.50	Dividend	30.4.03
Margaret Rosalind Dwyer, 23 Wellington Terrace, Fullarton, S.A. 5063	18.10	Dividend	30.4.03
Susan Elizabeth Williams and Sandra Michelle Buzzard, <Blossoming Investments A/C>, RMB 813, Donnybrook, W.A. 6239	22.70	Dividend	30.4.03
John G. Wilson (deceased estate), c/o J. Wilson, 46 Kent Road, North Ryde, N.S.W. 2113	27.10	Dividend	30.4.03
Jane Patricia Ridgley and Doreen Ridgley, 54 Wellington Crescent, Torquay, Qld. 4655	30.00	Dividend	30.4.03
April Joy Davey, c/o 15 Condada Avenue, Parkholme, S.A. 5043	30.00	Dividend	30.4.03
Leila M. Avery, P.O. Box 190, Mittagong, N.S.W. 2575	40.60	Dividend	30.4.03
Josephine L. Blanckensee, 4/110 Matheson Road, Applecross, W.A. 6153	58.10	Dividend	30.4.03
Peter John Cruise and Brenton Phillip Lynch, 268 Coombe Street, Nangwarry, S.A. 5277	100.00	Dividend	30.4.03
William Wong, 6/66 Shackleton Road, Mount Eden, Auckland, N.Z.	100.00	Dividend	30.4.03
Michela V. Skerbec, 10 Wright Street, Balmoral, Qld 4171	140.00	Dividend	30.4.03
Matthew Richardson and Jonathan Hilton Hulme, Endeavour Investment Group, P.O. Box 33216, North Shore Mail, Auckland, N.Z.	185.00	Dividend	30.4.03
Noriyuki Kawaguchi, 6353-26 Yamato Nishimuta, Chikugo-Shi, Fukuoka Prefecture, Japan	200.00	Dividend	30.4.03
Catherine Elizabeth Prideaux, 15 Dynnyrne Road, Dynnyrne, Tas. 7005	200.00	Dividend	30.4.03
Robert Lesley Watkins and Ermindita Watkins, P.O. Box 537, Archerfield, Qld 4108	200.00	Dividend	30.4.03
The Unitarian Church of South Australia Inc., 99 Osmond Terrace, Norwood, S.A. 5067	206.00	Dividend	30.4.03
Myles Langley Jones, 4 Thomas Street, Jamestown, S.A. 5491	367.50	Dividend	30.4.03

Name and Address of Owner on Books	Total Amount Due to Owner \$	Dividend Payment	Date
Eric Stephen Poulter and Susan Poulter, 39 Colliers Close, Newcastle East, N.S.W. 2300	452.30	Dividend	30.4.03
Newpint Pty Limited, 69 Flinders Way, Griffith, A.C.T. 2603	510.00	Dividend	30.4.03
Peter Belbin (deceased estate), c/o Austen Brown Thompson, P.O. Box 832, Dubbo, N.S.W. 2830	750.00	Dividend	30.4.03

UNCLAIMED MONEYS ACT 1891

Register of Unclaimed Moneys held by Elders Rural Services Australia Limited for the Year ended 2002

Name of Owner on Books and Last Known Address	Total Amount Due to Owner \$	Cheque No.	Date When First Due
Graham Thomas Varley, 88 Baker Street, Glen Gowerie, S.A. 5044	13.30	754940	27.8.02
Theodor R. Schultz, 42 Torrens Street West, Hilton, S.A. 5033	16.00	754788	27.8.02
Startrack Express, Locked Bag 2, St Marys, N.T. 1790	19.73	624219	6.6.02
Garden Grove Supplies, P.O. Box 292, Golden Grove, S.A. 5125	23.76	598972	2.4.02
Kerryl E. McCarthy, 2 Jackson Terrace, Enfield, S.A. 5085	28.00	753214	27.8.02
Clarks Foodland Barmera, Bice Street, Berri, S.A. 5343	28.68	191841	5.7.02
G. H. Warren, 42 Dunure Terrace, Jamestown, S.A. 5491	29.55	688866	26.11.02
Katherine Mitre 10, P.O. Box 530, Katherine, N.T. 0851	37.95	710073	27.12.02
National 1 Limited, P.O. Box 1946, Katherine, N.T. 0851	42.07	626818	26.7.02
Loxton Computing, 39 East Terrace, Loxton, S.A. 5333	42.35	638819	23.8.02
Trevor James Watson and Beverley Ann Watson, 41 Matthew Flinders Drive, Victor Harbor, S.A. 5211	43.20	754808	27.8.02
Dr and H. M. Hurrell, RSD, Yankalilla, S.A. 5203	49.50	713248	30.12.02
Office of Consumer and Business Affairs, G.P.O. Box 1407, Adelaide, S.A. 5001	58.00	679893	12.11.02
Premier Proline, P.O. Box 33, Kilburn North, S.A. 5084	58.74	700424	11.12.02
Bell Judy, 7 Radford Drive, Port Pirie, S.A. 5540	60.00	682373	15.11.02
G. A. Schultz, 47 Cooper Street, Berri, S.A. 5343	60.00	694478	2.12.02
Pamela V. Phillips, 18 Dartmore Close, Narracourt, S.A. 5271	64.00	756189	27.8.02
Singleton (Traders) Pty Ltd, P.O. Box 59, Kilkenny, S.A. 5009	67.98	571444	22.1.02
Donald Allan Flett and Dorothy Jean Flett, P.O. Penola, S.A. 5277	68.70	752556	27.8.02
Alfred John Peacock and Betty Dawn Peacock, Glencoe West, S.A. 5291	74.10	755258	27.8.02
Unknown	87.40	—	Unknown
Unknown, Mildura Property Management Cheque, Vic.	96.75	—	19.9.02
Bolsdon & Smole, 869 Eastbank Road, Nana Glen, N.S.W. 2450	100.77	207172	28.11.02
Donald Maurice Hughes and Suzanne Catherine Huges, 'Glenara', Walbundrie, N.S.W. 2640	103.90	753655	27.8.02
C. J. and S. J. Grills (as trustee for Jim and Lucy Grills), Mandaring, Holbrook, N.S.W. 2644	104.18	768921	14.10.02
Ruby Hilda Dawn Anderson, P.O. Box 234, Millicent, S.A. 5280	104.20	752168	27.8.02
R. W. Robinson & Co., 45 Birdwood Street, Corowa, N.S.W. 2646	106.00	756028	27.8.02
Helen McCarthy, c/o Elders Limited, P.O. Box 132, Gunnedah, N.S.W. 2380	109.79	653656	25.9.02
Wedgwood Holdings Pty Ltd, Private Bag 842, Albury, N.S.W. 2640	115.80	754552	27.8.02
A. & S. Winter, 9 Bexley Court, Vista, S.A. 5091	118.73	590729	8.3.02
Peter H. Hanson, Box 578, Deniliquin, N.S.W. 2710	119.50	753500	27.8.02
Banksia Grove Florist, 66 Rankin Street, Forbes, N.S.W. 2871	120.00	688290	26.11.02
C. M. Duffy, P.O. Box 1115, Deniliquin, N.S.W. 2710	121.60	756562	27.8.02
Philmac Pty Ltd, P.O. Box 204, Plympton, S.A. 5038	121.69	338287	15.1.02
S. Bradford, c/o L. Considine, Box 34, S.A. 5280	122.75	780059	24.7.02
S. Bradford, c/o L. Considine, Box 34, S.A. 5280	122.75	780058	24.7.02
Dn's Newsagency, 1 McCoy Street, Waikerie, S.A. 5330	128.28	617920	27.5.02
Brian Peter Edwards (deceased estate) and Nessie Mary Edwards (deceased estate), c/o Wallace Degaris & Co., P.O. Box 7, S.A. 5280	133.80	756541	27.8.02
Munns D. T. and V. A., 31 Kelly Street, South Grafton, N.S.W. 2460	135.00	358173	18.4.02
Alan Thomas Holden, P.O. Box 129, Wagga Wagga, N.S.W. 2650	140.90	754112	27.8.02
Evelyn Joyce MacLean and Margaret Isabel Anderson, 67 Blue Hills Road, O'Halloran Hill, S.A. 5158	146.60	753165	27.8.02
Ulindah Pastoral Co., 'Ulindah', Binnaway, N.S.W. 2395	150.68	666628	22.10.02
Goodyear Auto Service Loxton, 32 Bookpurnong Terrace, Loxton, S.A. 5333	160.00	639595	26.8.02
D. Doohan Ballantyne, Cassilis, N.S.W. 2329	161.03	662518	11.10.02
Unitus Industries Pty Ltd, 660 Kiewa Street, Albury, N.S.W. 2640	165.60	754540	27.8.02
Office of State Revenue	170.00	783218	23.9.02
Bypass Stockfeeds, Hillgrove, Young Road, N.S.W. 2586	170.50	182939	18.6.02
G. R. and M. J. Morrow, 2 Belt Road, Millicent, S.A. 5280	171.90	756302	27.8.02
Novotel Adelaide on Hindley, P.O. Box 8144, Hindley Street, S.A. 5000	175.00	669758	29.10.02
John T. Martin, G. M. Martin, David M. and Rex B. Martin, 'Larose', Barham, N.S.W. 2732	177.70	753938	27.8.02
Holbrook Newsagency, 137 Albury Street, Holbrook, N.S.W. 2644	185.10	185455	25.6.02
C. & G. Basham, 4/3 Reus Court, Alice Springs, N.T. 0870	186.69	769812	30.4.02

Name of Owner on Books and Last Known Address	Total Amount Due to Owner \$	Cheque No.	Date When First Due
Top End Rural Supplies, P.O. Box 1746, Katherine, N.T. 0851	198.43	663568	15.10.02
El Sanders, c/o P.O. Box 378, Echunga, S.A. 5153.....	203.93	690737	27.11.02
Geoffrey Harold Parr and Toni Lynette Parr, 'Coolabah', Box 62, N.S.W. 2675	207.20	756096	27.8.02
Office of State Revenue.....	210.00	783216	23.9.02
Stock & Station Agents Assoc., P.O. Box 1939, Bondi Junction, N.S.W. 1355.....	220.00	701105	12.12.02
ABL Distribution, 30 Central Park Avenue, Ashmore, N.S.W. 2414.....	236.50	341585	31.1.02
J. Dawson, RMB 608, Hammond Avenue, N.S.W. 2650.....	240.35	683596	19.11.02
Gaynor Ciavatta, P.O. Box 261, Mount Gambier, S.A. 5290.....	261.35	781190	16.8.02
P. J. and J. A. Pascoe, P.O. Box 48, Holbrook, N.S.W. 2644.....	263.44	767518	8.10.02
Kenneth Wallace Ross and Winifred Ross, Kikabel, Holbrook, N.S.W. 2644.....	266.60	755105	27.8.02
Geoffrey Harold Parr, 'Coolabah', Box 62, N.S.W. 2675.....	272.50	754885	27.8.02
Colin Angus Sutherland and Susan Jane Sutherland, P.O. Box 887, Millicent, S.A. 5280.....	274.40	755343	27.8.02
Nubrygyn Partnership, Nubrygyn, Euchareena, N.S.W. 2866.....	274.59	191629	4.7.02
Burtons Saddlery, P.O. Box 129, Armidale, N.S.W. 2350.....	285.75	365303	24.5.02
Jean Milne, Greg Greg, Tooma, N.S.W. 2642.....	290.40	742511	5.7.02
Mavis Jean Skeer, P.O. Box 646, Millicent, S.A. 5280.....	324.80	754407	27.8.02
Rosina Mary James, 34 Thornber Street, Unley Park, S.A. 5061	330.00	—	Unknown
D. J. Schiller, 'Tarwong', Hay, N.S.W. 2711	330.00	589216	6.3.02
Trevor Raymond Skeer, P.O. Box 646, Millicent, S.A. 5280.....	336.50	754812	27.8.02
J. W. Urquhart, P.O. Box 426, Casino, N.S.W. 2470.....	336.66	370836	18.6.02
Atkins Carlyle, P.O. Box 3473, Winnellie, N.T. 0821	336.91	590824	11.3.02
E. M. Griffiths, M. R. Griffiths and J. A. Griffiths, 'Stanbridge', Balranald, N.S.W. 2715	339.00	752006	27.8.02
Compaq Computer Australia P/L, P.O. Box 384, Concord West, N.S.W. 2138.....	346.00	691737	28.11.02
Merawah Poll Herefords, Andrew MacKay, 'Merawah', N.S.W. 2409.....	346.32	193570	25.9.02
Koala Hats Pty Ltd, P.O. Box 182, Liverpool BC, N.S.W. 1871	352.00	574512	30.1.02
J. E. and V. M. O'Brien, 113 Brae Street, Inverell, N.S.W. 2360	373.45	632359	8.8.02
J. Dawson, RMB 608, Hammond Avenue, N.S.W. 2650.....	391.87	698380	6.12.02
Croplands Equipment Pty Ltd, P.O. Box 2441, Dry Creek, S.A. 5094	399.52	705881	20.12.02
Austen Brown Thompson, Argent Street, Broken Hill, N.S.W. 2880	400.00	785180	5.9.02
Byrne Edward Evans and Kaylene Gwenneth Evans, 'Sunny Hills', Humula, N.S.W. 2652	406.10	752487	27.8.02
Footersville, P.O. Box 125, Woodville, S.A. 5011.....	434.50	598872	2.4.02
Osborne Signs, 3 Reginald Street, Port Pirie, S.A. 5540	440.00	637102	20.8.02
Jenell Agrispray, 190-196 Hovell Street, Cootamundra, N.S.W. 2590.....	451.00	587550	1.3.02
AMP Society	466.67	778989	2.7.02
Jarrett Industries Pty Ltd, 15 Coongie Avenue, Edwardstown, S.A. 5039	472.68	657836	1.10.02
Hardi Spraying Equipment (N.S.W.), P.O. Box 3085, Rouse Hill, N.S.W. 2155	479.60	580095	13.2.02
Austrahose (S.A.) Pty Ltd, P.O. Box 4114, Seaton, S.A. 5023	496.42	633668	12.8.02
Transforce Bulk Haulage, P.O. Box W176, Dubbo, N.S.W. 2830.....	526.68	574728	30.1.02
AMP Society	562.50	785015	3.9.02
Fernz Minerals, P.O. Box 18, Botany, N.S.W. 1455.....	611.88	355803	3.4.02
Nicholas K. Oldfield, Mungerannie Station, Channel Mail, S.A. 5700.....	669.63	698149	6.12.02
Australian Billboard Connections, 399 Townsend Street, Albury, N.S.W. 2640 ...	763.40	640370	26.8.02
Transport SA, P.O. Box 480, Kadina, S.A. 5554	768.00	181069	14.6.02
Pacific Access Sydney, Tower 2, L21, 201 Sussex Street, N.S.W. 2000	784.30	650090	16.9.02
Graham O'Neill, 11 Knox Street, Double Bay, N.S.W. 2028	803.80	776573	11.7.02
Office of State Revenue.....	830.00	783240	24.9.02
Mann Bros., P.O. Box 43, South Grafton, N.S.W. 2461	991.45	383377	21.8.02
Gidgee Enterprises, James and Helen Gooden, c/o Friedleb & Byrne, 99 Peter Street, N.S.W. 2650	1 010.92	787509	21.10.02
Craig Congram Livestock, Jacana Park, Riverina Highway, N.S.W. 2713	1 015.74	764652	26.9.02
Hildabuilt Pty Ltd, 34 Elder Terrace, Hawker, S.A. 5434.....	1 047.20	576759	5.2.02
Commins Hendriks.....	1 150.61	780638	6.8.02
Blighty Football Club, Riverina Highway, Blighty, N.S.W. 2713.....	1 214.89	771774	24.10.02
Knightleigh Plantations, (deceased estate) J. C. Boyd, Dulguigan, N.S.W. 2484.....	1 402.83	395478	21.10.02
Rocca Farms Pty Ltd, c/o Elders Limited, Katherine, N.T. 0850.....	1 610.00	786617	1.10.02
Minnamurra Pastoral Co., Cortina, Wollar, N.S.W. 2850.....	1 838.00	695563	3.12.02
Brian Unthank Rodwell, Box 613, Albury, N.S.W. 2640.....	1 874.39	778581	18.11.02
Smith's Northern Territory, P.O. Box 886, Dubbo, N.S.W. 2830	2 050.25	640897	27.8.02
Caloma Transport, Caloma, S.A. 5501.....	2 676.23	707342	23.12.02
Gunning Bialla Circuit Sale Committee, c/o J. S. Shaw, 'Rutherford', N.S.W. 2581	2 717.88	790291	21.11.02
E. & S. Allcock, 265 River Street, Maclean, N.S.W. 2463	3 115.89	206501	12.9.02
Jarrett Industries Pty Ltd, 15 Coongie Avenue, Edwardstown, S.A. 5039	3 960.00	673392	Unknown
Ace Ohlsson Pty Ltd, P.O. Box 90, Flemington Markets, N.S.W. 2129	5 728.15	696178	4.12.02
Fast Flow Augers, 10 Kiora Crescent, Yennora, N.S.W. 2161	6 160.00	600696	5.4.02
H. R. Stibbard, c/o Palmers, 155 Lachlan Street, N.S.W. 2871	13 825.00	763534	15.01.02

UNCLAIMED MONEYS ACT 1891

Register of Unclaimed Moneys held by Elders Rural Services Australia Limited for the Year ended 2003

Name of Owner on Books and Last Known Address	Total Amount Due to Owner \$	Cheque No.	Date When First Due
A. C. Pfeiler, P.O. Box 901, Murray Bridge, S.A.	12.22	730424	29.1.03
Kathleen Aroha Etchell, 78 Warrawong Street, Wagga Wagga, N.S.W. 2650	12.50	—	Unknown
Kim Maree Higgins, 24 Victoria Street, Bendigo, S.A. 3550	12.50	—	Unknown
Kevin James Johnson, 47 Spica Street, Southern Cross, W.A. 6426	12.50	—	Unknown
Fiona Louise Ritchie, 18 Lugarno Street, Redwood Park, S.A. 5097	12.50	—	Unknown
M. E. Hartney, c/o Albany Woolstores, Albany, W.A. 6330	13.97	796507	6.2.03
I. Stuart, P.O. Box 777, Strathalbyn, S.A. 5255	14.37	725658	23.1.03
R. J. Gillich, Lot 17, Bowhill, S.A. 5238	15.75	335136	7.5.03
M. Cazzalato, RMB 4064, Jervois Road, S.A. 5259	16.40	331141	5.5.03
Collins Serwell, Makin Street, Keith, S.A. 5267	16.90	315131	29.4.03
Robert Lenga Super Fund A/C, 69-83 Botany Street, Waterloo, N.S.W. 2017	19.00	—	Unknown
SYP Motors, 9 Main Street, Minlaton, S.A. 5575	20.00	668456	27.10.03
W. T. and M. H. Lakin, P.O. Box 2282, Port Lincoln, S.A. 5607	20.65	502966	30.7.03
Bowpine Pty Ltd, Level 41, The Gateway, 1 Macquarie Place, N.S.W. 2000	25.00	—	Unknown
Phillip Bruce Francis, 19 Butler Street, Esperance, W.A. 6450	25.00	—	Unknown
Simon Jock Kermode, 3/3 Edward Street, Bondi, N.S.W. 2026	25.00	—	Unknown
Kimiora Mii-Taomia, 5 Anderson Avenue, Liverpool, N.S.W. 2170	25.00	—	Unknown
David Edward Mortimer, 99 Cowper Street, Wee Waa, N.S.W. 2388	25.00	—	Unknown
Joseph Anthony Sullivan, Flat 2, 261 Young Street, Wayville, S.A. 5034	25.00	—	Unknown
David Temainatanga Turia, 10 Westringia Place, Macquarie Fields, N.S.W. 2564	25.00	—	Unknown
Robert Bennett Wheeler, 29 Balmoral Crescent, Wagga Wagga, N.S.W. 2650	25.00	—	Unknown
Loxton North Newsagency & Bottle, c/o Loxton North Post Office, Loxton North, S.A. 5333	25.60	544806	29.8.03
N. D. Griffiths, 3 Kerrins Court, Highton, Vic. 3216	25.97	796445	6.2.03
Geoffrey Frahm, 4/6 Cycad Place, Alice Springs, N.T. 0870	26.76	809578	4.6.03
A. Trotta, P.O. Box 258, Bridgewater, S.A. 5155	30.40	555897	2.9.03
Donal Craig & Associates, 30 Market Street, Adelaide, S.A. 5000	30.48	801407	10.3.03
A. R. Earle, 7/184 Jubilee Highway, Mount Gambier, S.A. 5290	31.79	794932	13.1.03
D. C. Dare, c/o Elders Limited, 37 Murray Street, S.A. 5118	33.50	796476	6.2.03
S. M. Birch, 4/694 Orrong Road, Toorak, Vic. 3142	40.13	796322	5.2.03
J. M. D. Kregar, c/o Elders Limited, Barmera, S.A. 5345	44.84	819297	6.11.03
Assemble Ex Location Stocks, Refer Menu Option 464, (No Supplier Payment), S.A.	48.40	194991	3.3.03
C. R. and J. A. Childs, 21 Centenary Road, Streaky Bay, S.A. 5680	49.50	616701	1.10.03
P. F. and D. K. Rose, P.O. Box 60, Karoonda, S.A. 5307	49.90	688906	4.11.03
Katherine Mitre 10, P.O. Box 530, Katherine, N.T. 0851	50.00	673907	29.10.03
R. Reynolds, 54 East Street, Townsville, Qld 4810	56.04	670895	28.10.03
Wahroonga Park, P.O. Box 1596, Murray Bridge, S.A. 5254	56.77	521240	7.8.03
Campus Nominees Pty Ltd, P.O. Box 100, Morphett Vale, S.A. 5162	63.40	651987	17.10.03
J. R. and D. A. Askren, 14/175 Stephens Road, Alice Springs, N.T. 0870	66.40	816173	25.8.03
Wahroonga Park, P.O. Box 1596, Murray Bridge, S.A. 5254	67.19	573170	11.9.03
Langsford Water, RMB 773, Vicks Road, Cherry Gardens, S.A. 5157	68.53	322460	1.5.03
M. J. Haldeman, 3/15 Adamson Avenue, Alice Springs, N.T. 0870	69.17	—	20.05.03
P. Messenger, 9 Quarry Street, Burra, S.A. 5417	73.41	196	25.11.03
Wodhue Pty Ltd, 9A Anzac Highway, Keswick, S.A. 5035	74.06	813504	8.8.03
K. A. Turner, 207 Burgridge Road, Cowandilla, S.A. 5033	76.79	796504	6.2.03
J. A. Eddy, c/o Elders Real Estate, Alice Springs, N.T. 0870	77.00	818929	29.10.03
Dept of Foreign Affairs & Trade, RG Casey Building, John McEwen Crescent, A.C.T. 0221	83.00	127529	24.2.03
Unknown	87.40	—	Unknown
Unknown	87.40	—	Unknown
J. L., L. J. and S. R. Pfitzner, Box 3, Coonalpyn, S.A. 5265	89.63	741378	1.12.03
A. G. Brooks, P.O. Box 65, Rendelsham, S.A. 5280	96.03	802084	18.3.03
Whanau Shearing Pty Ltd, c/o Elders VP, Albert Street, N.S.W. 2710	100.00	480503	3.11.03
K. & V. J. Ryan, 167 Mastons Road, Karangi, N.S.W. 2450	100.00	233527	1.12.03
Homebush Recreation Club Inc., c/o A. Connellan, Treasurer, Narwie Property, N.S.W. 2715	100.00	742206	1.12.03
Wahroonga Park, c/o M. D. Ross, P.O. Box 1596, S.A.	104.67	247898	27.3.03
Des Groth Radio-Tronics, P.O. Box 1420, Moree, N.S.W. 2400	110.00	510571	1.8.03
Ingledow Pastoral Company, 28 Elmslea Drive, Bungendore, N.S.W. 2621	110.10	822175	17.12.03
Office Consumer & Business Affairs	114.00	800145	14.2.03
John Burke, Adam Street, Goodooga, N.S.W. 2831	115.00	807876	18.7.03
Bourke Agricultural Repairs, P.O. Box 218, Bourke, N.S.W. 2840	116.60	372406	26.5.03
David Heath, c/o NACC, P.O. Box 2599, N.T. 0801	119.93	801839	22.8.03
Lawrence John Curtis, 9 Esplanade, Tumby Bay, S.A. 5605	125.00	—	Unknown
Riverina Broadcasters, P.O. Box 480, Wagga Wagga, N.S.W. 2650	132.00	539017	26.8.03
Commander Australia, P.O. Box 302, Silverwater, N.S.W. 2128	136.64	596760	23.9.03
Commander Australia, P.O. Box 302, Silverwater, N.S.W. 2128	139.94	524620	8.8.03
Rural Press Ltd Network Circulation, Farm Weekly Subscriptions, P.O. Box 999, N.S.W. 2754	146.80	515784	5.8.03
A. and O. Abdullah, c/o Elders Limited, Barmera, S.A. 5345	149.37	819292	6.11.03
Simon Packer, 'Kanlimbra', Balldale, N.S.W. 2646	150.00	610625	29.9.03
Manwill, 20 Railway Terrace, Copley, S.A. 5732	152.00	741557	1.12.03

Name of Owner on Books and Last Known Address	Total Amount Due to Owner \$	Cheque No.	Date When First Due
Dalton Packaging P/L, 25 Krauss Avenue, South Lismore, N.S.W. 2480.....	155.47	506502	31.7.03
Judy Dunning	167.95	818278	15.10.03
Paul Gavin, c/o C. Ferris, 305 Warranzanmil Creek, N.S.W. 2474.....	178.00	772682	12.12.03
A. Simpson.....	180.00	802472	26.3.03
Territory Auto Electrics, 2 Day Street, Talbingo, N.S.W. 2720.....	184.25	454894	3.7.03
Chem Turf, P.O. Box 2173, Smithfield, N.S.W. 2164.....	198.00	735303	3.2.03
Keith and Kerry Rowe, c/o Elders Real Estate, Condobolin, N.S.W. 2877.....	209.04	818671	23.10.03
David Foote Plumbing, P.O. Box 410, Kapunda, S.A. 5373.....	220.00	803160	8.4.03
W. R. and W. M. Finlayson, P.O. Box 242, Brewarrina, N.S.W. 2839.....	220.00	646739	15.10.03
Seto's, (no address on file).....	230.90	808567	4.9.03
Janatos Pty Ltd, c/o Allan Kelly, P.O. Box 69, N.S.W. 2720.....	233.13	818265	15.10.03
Unknown, Mildura Property Management Cheque, Vic. 3500.....	244.84	—	7.8.03
Tower Lodge Pty Ltd, Halls Road, Pokolbin, N.S.W. 2320.....	251.96	821906	3.12.03
CIC Insurance, P.O. Box 136, Walgett, N.S.W. 2832.....	260.00	202605	5.3.03
P. A. and S. Bruton, Kalimna Park, Deniliquin, N.S.W. 2710.....	268.09	127020	24.2.03
McGrath Total Real Estate Training, 191 New South Head Road, N.S.W. 2027.....	275.00	360897	20.5.03
Wesfarmers Landmark (Mudgee), P.O. Box 133, Mudgee, N.S.W. 2850.....	276.10	808340	20.8.03
G. Swinstead (Personal), P.O. Box 6211, Paramatta Business Centre, N.S.W. 2150.....	280.80	491269	24.7.03
K. Hren, P.O. Box 330, Renmark, S.A. 5341.....	283.96	127365	24.2.03
Widderin Pastoral Company, c/o D. McDonald, 'Widderin', N.S.W. 2732.....	285.00	802047	18.3.03
Davey Pumps, Unit 1, 11 Deadman Road, Moorebank, N.S.W. 2170.....	288.37	805888	31.12.03
J. P. and J. A. Abdilla Pigs Pty Ltd, P.O. Box 145, Two Wells, S.A. 5501.....	325.50	266296	2.4.03
Sydney IVF Limited, 4 O'Connell Street, Sydney, N.S.W. 2000.....	330.00	821058	3.10.03
Rosina Mary James, 34 Thornber Street, Unley Park, S.A. 5061.....	330.00	—	Unknown
Rosina Mary James, 34 Thornber Street, Unley Park, S.A. 5061.....	330.00	—	Unknown
V. Gladwin, 12 Shalford Terrace, Campbelltown, S.A. 5074.....	338.79	795410	21.1.03
PJH Pastoral, P.O. Box 398, Tenterfield, N.S.W. 2372.....	358.05	555738	2.9.03
Allan Trethewey, P.O. Box 307, Gunnedah, N.S.W. 2380.....	370.95	445440	30.6.03
J. S. and J. M. Bramley, Box 220, Yankalilla, S.A. 5203.....	386.46	772703	12.12.03
Country Energy Sydney, Locked Bag W143, Sydney, N.S.W. 1292.....	392.30	775371	15.12.03
Josh Hagar, Inveravon, Old Junee, N.S.W. 2652.....	438.95	644399	14.10.03
Australian Meat Holdings Tabbita, P.O. Box 1574, Griffith, N.S.W. 2680.....	453.08	407130	11.6.03
Maral Pastoral P/L, P.O. Box 330, Hay, N.S.W. 2711.....	460.35	803289	10.4.03
Deveigne Transport, 83 Margaret Street, Dubbo, N.S.W. 2830.....	480.15	365908	22.5.03
Dr A. H. Kaines, P.O. Box 181, Hahndorf, S.A. 5245.....	486.07	738089	6.2.03
Incitec Fertilizers Limited, c/o Elders, Mudgee, N.S.W. 2850.....	495.00	808828	19.9.03
Canowindra @ Home, P.O. Box 2000, Canowindra, N.S.W. 2804.....	500.00	195375	3.3.03
G. and R. Earle, 9 Polluck Crescent, Clare, S.A. 5453.....	505.39	610382	29.9.03
Andrew C. Dalglish, P.O. Box 2193, Katherine, N.T. 0851.....	567.60	408871	12.6.03
K. & S. Freighters, P.O. Box 567, Mount Gambier, S.A. 5290.....	605.00	694541	6.11.03
Narrabri Haulage Pty Ltd, P.O. Box 99W, Narrabri, N.S.W. 2390.....	633.60	110475	14.2.03
Janus Australia Pty Ltd, (trading as Training Improvements), P.O. Box 1009, Wagga Wagga, N.S.W. 2650.....	646.00	815505	8.10.03
J. S. and J. M. Bramley, Box 220, Yankalilla, S.A. 5203.....	674.46	800232	29.12.03
B. J. Kelman, Forest Hill, Burruga, N.S.W. 2795.....	676.50	821542	7.11.03
K. Caldwell (trading as Southern Slopes Suffolks), Wyonia via Thuddungra, N.S.W. 2594.....	751.35	127608	24.2.03
A. C. O'Brien, Box 46, Barham, N.S.W. 2732.....	753.45	307638	24.4.03
Baycorp Advantage, P.O. Box 967, North Sydney, N.S.W. 2059.....	939.34	481974	8.12.03
Doohan Maurice, Elford Road, Dobies Bight, N.S.W. 2470.....	960.30	115621	18.2.03
D. W. and P. H. Bennett, c/o Primac Elders Ltd, P.O. Box 121, Casino, N.S.W. 2470.....	1 101.59	210401	29.1.03
James M. Oldfield, c/o M. T. Oldfield, P.O. Box 157, S.A. 5411.....	1 117.43	813800	15.8.03
Collier & Miller, Irrigation Way, Griffith, N.S.W. 2680.....	1 292.07	735428	3.2.03
L. J. Hooker Commercial, N.S.W. 2000.....	1 641.13	808303	19.8.03
R. R. Alcock, P.O. Box 35, Arno Bay, S.A. 5603.....	1 860.54	487467	22.7.03
Julina Burton Burns Trust, c/o Richard Crawford, Leapfrog Training, 32 Halsbury Avenue, Kingswood, S.A. 5062.....	2 500.00	821865	1.12.03
Overton Transport, c/o L. J. and P. J. Hamston, Lameroo, S.A. 5302.....	2 506.49	818114	10.10.03
T. Blundell, Bombowlee via Tumut, N.S.W. 2720.....	2 713.51	739772	7.2.03
Michael James Eccleston Farming, P.O. Box 1744, Bowral, N.S.W. 2576.....	3 174.62	679679	31.10.03
D. J. MacKenzie, P.O. Box N278, Grosvenor Place, N.S.W. 2000.....	3 582.24	480344	17.7.03
Rosina Mary James, 34 Thornber Street, Unley Park, S.A. 5061.....	4 125.00	—	Unknown
P. D. and A. Green, P.O. Box 92, Millicent, S.A. 5280.....	7 408.93	795879	29.1.03
Total	133 629.11		

UNCLAIMED MONEYS ACT 1891

Register of Unclaimed Moneys held by The Community Co-operative Store (Nuriootpa) Ltd

Name and Address of Owner	Amount \$	Date
C. K. Aspinall, P.O. Box 157, Eudunda, S.A. 5374	42.26	23.9.03
K. J. Applebee, P.O. Box 18, Mount Torrens, S.A. 5244	38.68	30.1.04
ACRM Central Belt, P.O. Box 233, Nuriootpa, S.A. 5355	78.04	16.12.02
H. G. Albers, Anlaby Station, Kapunda, S.A. 5373	298.20	17.11.03
M. E. Arbon, 11 Causby Crescent, Willaston, S.A. 5118	94.63	10.11.03
P. K. Arharidis, P.O. Box 309, Virginia, S.A. 5120	13.74	10.3.03
P. C. Arthur, 4/158 Murray Street, Nuriootpa, S.A. 5355	31.12	1.8.03
R. Beattie, RSD, Black Hill Road, Kongolia, S.A. 5353	195.99	30.11.03
Barossa News Pty Ltd, P.O. Box 43, Tanunda, S.A. 5352	106.99	21.11.01
L. N. Barrett, P.O. Box 663, Barmera, S.A. 5345	43.31	22.6.03
H. M. Buttressgrove, P.O. Box 393, Angaston, S.A. 5353	195.78	10.10.03
G. Brooke, RSD Warren Road, Mount Crawford, S.A. 5351	101.20	5.12.03
J. C. Beckett, 16 May Court, Evanston, S.A. 5116	57.94	12.8.04
L. A. Brierley, P.O. Box 547, Lyndoch, S.A. 5351	85.79	17.6.04
O. J. Barratt, P.O. Box 187, Truro, S.A. 5356	267.24	17.7.03
D. Branson, 5 Anzac Avenue, Swan Reach, S.A. 5354	116.68	24.11.04
M. P. Britton, Unit 4, 18 Fourth Street, Gawler, S.A. 5118	24.63	15.7.01
K. L. Buckby, P.O. Box 33, Cockatoo Valley, S.A. 5351	42.94	24.12.03
D. Burman, P.O. Box 8, Stockport, S.A. 5410	31.82	19.4.05
C. Burne, c/o Post Office, Tanunda, S.A. 5352	39.56	14.4.03
R. C. Blackwell, 8 Smith Street, Angaston, S.A. 5353	15.63	1.2.04
J. L. and P. M. Barfield, 3 Solomon Street, Kapunda, S.A. 5373	15.53	29.12.05
T. J. Beeston and J. J. Moore, P.O. Box 55, Norton Summit, S.A. 5136	12.57	27.7.03
M. Bottroff, 83 Cliff Street, Mannum, S.A. 5238	33.77	7.12.04
D. Bouts and J. Hawkes, P.O. Box 209, Eudunda, S.A. 5374	62.02	8.10.03
C. E. Clarke, 36 George Street, Williamstown, S.A. 5351	35.31	30.4.03
S. L. Cartwright, c/o Post Office, Sedan, S.A. 5353	18.84	10.9.03
T. Croucher, 6 Aitken Street, Berri, S.A. 5343	156.01	1.6.03
S. Ciemcioch, 16 Doering Street, Tanunda, S.A. 5352	17.91	6.4.04
S. A. and H. M. Carruthers, P.O. Box 438, Angaston, S.A. 5353	83.24	1.8.03
P. and A. Coulter, 59 Murray Street, Angaston, S.A. 5353	40.27	7.8.03
K. Curtis, Tanunda Caravan Park, Tanunda, S.A. 5352	41.46	20.5.03
P. J. and J. E. Cummings, P.O. Box 216, Auburn, S.A. 5451	38.43	20.5.03
S. Carroll, P.O. Box 275, Willaimstown, S.A. 5351	18.59	4.9.03
F. C. B. Childs, 15 Gothic Avenue, Nuriootpa, S.A. 5355	10.31	1.3.03
F. A. Dutschke, 16 Centenary Avenue, Nuriootpa, S.A. 5355	161.34	13.3.03
B. C. Darling, 31-33 Rodda Drive, Penrice, S.A. 5353	822.49	22.12.03
J. and S. Donaldson, 41 Greenock Road, Nuriootpa, S.A. 5355	178.05	1.4.03
T. A. Davies, P.O. Box 200, Nuriootpa, S.A. 5355	71.46	22.5.03
M. Douglas, P.O. Box 8, Tanunda, S.A. 5352	27.04	24.3.03
P. L. Driesener, 31 Mildred Street, Kapunda, S.A. 5373	10.00	23.2.03
C. Davies-Jansen, 2 Sheringa Crescent, Salisbury Park, S.A. 5109	15.37	8.8.03
G. G. Davison, 30A Park Avenue, Nuriootpa, S.A. 5355	134.03	1.8.03
R. Dixon, c/o Elderton Wines, Nuriootpa, S.A. 5355	12.56	1.8.03
T. Eggleton and K. MacAuley, 63 Angas Street, Tanunda, S.A. 5352	56.07	27.8.03
M. Ellerbeck, P.O. Box 204, Kapunda, S.A. 5373	35.54	24.12.03
G. W. Egan, 1/18 College Street, Tanunda, S.A. 5352	10.95	26.5.03
C. W. Everett, P.O. Box 308, Lyndoch, S.A. 5351	15.34	14.4.03
N. L. Fletcher, 7 Barossa Street, Nuriootpa, S.A. 5355	54.12	1.6.03
S. Fitch, P.O. Box 343, Williamstown, S.A. 5351	433.38	30.11.03
A. G. Fielke, 12 Third Street, Nuriootpa, S.A. 5355	170.38	20.5.03
J. B. Farquhar, 2/46 Old Kapunda Road, Nuriootpa, S.A. 5355	138.73	16.10.03
S. Fletcher, 193 Murray Street, Tanunda, S.A. 5352	145.04	6.11.03
N. Fossey, 5 Madiera Street, Nuriootpa, S.A. 5355	22.91	23.9.03
D. Frame, P.O. Box 65, Murraytown, S.A. 5481	18.22	22.12.03
V. M. Grace, 2 Buna Terrace, Nuriootpa, S.A. 5355	299.63	20.7.02
K. N. Gepp, 30 Miller Street, Springton, S.A. 5235	72.28	1.4.03
D. and S. Gillies, Shearers Road, Springton, S.A. 5235	359.83	8.7.03
A. L. Grey, 43 Ball Street, Colyton, N.S.W. 2760	14.42	25.8.03
M. H. Gladwin, P.O. Box 257, Lyndoch, S.A. 5351	12.54	17.1.04
N. Gillett, P.O. Box 132, Nuriootpa, S.A. 5355	30.35	2.11.03
I. E. Henschke, 36 Greenock Road, Nuriootpa, S.A. 5355	1 212.03	20.1.04
T. M. Humphreys, P.O. Box 1326, Victor Harbor, S.A. 5211	74.83	1.10.03
S. J. Hentschke, 15 Sauvignon Street, Nuriootpa, S.A. 5355	190.46	15.3.05
L. A. Harries, 12 Staehr Street, Nuriootpa, S.A. 5355	133.50	23.12.03
S. J. Hill, 24 Maria Street, Tanunda, S.A. 5352	22.20	20.5.03
W. Heath, P.O. Box 230, Freeling, S.A. 5372	11.12	10.8.03
M. Haines-Adams, 22 Kingfisher Drive, Hewett, S.A. 5118	257.54	12.5.03
T. G. and E. M. Hutchinson, 8 Barons Court, Greenock, S.A. 5360	47.10	28.8.03
K. A. Howie, 1 Christchurch Street, Kapunda, S.A. 5373	40.00	10.8.03
J. C. Hodge, Stockwell Road, Angaston, S.A. 5353	117.20	29.12.03
M. E. Hargrave, P.O. Box 744, Gawler, S.A. 5118	21.36	23.6.04
T. G. Hutchinson and R. Gretton, c/o P.O. Box 173, Greenock, S.A. 5360	13.07	20.5.03
D. Hortin, P.O. Box 5272, CMB Stonefield via Truro, S.A. 5356	10.78	7.9.03
J. P. Higgins, 47 Mildred Street, Kapunda, S.A. 5373	32.60	22.12.03

Name and Address of Owner	Amount \$	Date
D. J. Halligan, P.O. Box 111, Blanchetown, S.A. 5357	12.09	22.9.03
C. M. Harris, P.O. Box 121, Wasleys, S.A. 5400	36.60	23.2.03
T. R. Hall, 43 Sturt Street, Angaston, S.A. 5353	90.00	26.2.03
R. P. Hewitt-Banks, 6 Main North Road, Willaston, S.A. 5118	10.77	24.12.03
A. M. Hole, 22 Wild Street, Williamstown, S.A. 5351	72.56	8.10.03
R. M. Hooper, P.O. Box 340, Lyndoch, S.A. 5351	13.86	20.7.02
J. M. Hutchins, 34 Barrat Street, Smithfield Plains, S.A. 5114	10.93	8.1.04
T. P. Hogan, 40 Dingera Avenue, North Plympton, S.A. 5037	13.24	26.11.03
G. R. Irvine, P.O. Box 296, Lyndoch, S.A. 5351	15.23	8.3.03
L. Ireland, Lot 162 Jutland Road, Springton, S.A. 5235	52.37	23.12.03
K. L. Kelertas, P. O. Box 96, Riverton, S.A. 5412	124.14	12.9.03
H. Kasza, 1 Redford Street, Springton, S.A. 5235	231.47	25.11.03
J. A. Kirk, P.O. Box 633, Nuriootpa, S.A. 5355	103.95	28.10.03
D. M. and L. C. Kelly, P.O. Box 116, Wudinna, S.A. 5652	53.17	10.3.03
N. Kieswetter, 46 Borrow Street, Freeling, S.A. 5372	13.30	19.12.03
C. L. Kavanagh, P.O. Box 407, Angaston, S.A. 5353	18.49	30.9.03
S. J. Kalleske, 2 The Crescent, Nuriootpa, S.A. 5355	14.27	9.1.04
J. B. Linke, 323 Sturt Road, Bedford Park, S.A. 5042	159.95	18.3.03
P. S. Luff, P.O. Box 597, Nuriootpa, S.A. 5353	520.20	24.12.03
P. A. Lyon, P.O. Box 465, Tanunda, S.A. 5352	67.34	13.10.03
K. M. Ledgard, 17 Jonathon Avenue, Nuriootpa, S.A. 5355	14.24	22.9.03
B. M. Littlely, 25 Blaxland Street, Nuriootpa, S.A. 5355	330.78	20.10.03
M. J. and T. L. Lambert, 122 Muray Street, Tanunda, S.A. 5352	87.09	8.10.03
C. A. Laszczak, P.O. Box 8, Daveyston, S.A. 5355	94.93	31.12.03
P. K. Loader, c/o Post Office, Cambrai, S.A. 5353	10.39	24.12.03
P. W. Lawton, 13 Cross Street, Angaston, S.A. 5353	109.59	1.6.03
C. A. Lever, c/o Post Office, Greenock, S.A. 5360	14.31	1.8.03
R. and F. Longbotham, RSD 35, Black Hill via Angaston, S.A. 5353	44.31	10.8.03
J. Lambert, 21 Neil Avenue, Nuriootpa, S.A. 5355	12.57	19.1.04
A. and M. MacKellar, P.O. Box 77, Cambrai, S.A. 5353	31.23	11.6.03
E. Martin, P.O. Box 29, Point Pass via Eudunda, S.A. 5374	23.85	17.1.04
J. E. E. and B. A. Marshall, P.O. Box 140, Truro, S.A. 5356	134.05	22.12.03
T. A. Martin, 70 Railway Terrace, North Lameroo, S.A. 5302	19.14	13.4.03
E. M. Martin, P.O. Box 469, Sedan, S.A. 5353	130.23	26.11.03
R. and S. M. Mandelc, 157 Murray Street, Tanunda, S.A. 5352	54.53	23.12.03
E. J. Marsh, 9 Swan Street, Angaston, S.A. 5353	50.21	4.8.03
F. E. Matthews, Lot 2 Para Wirra Road, Williamstown, S.A. 5351	11.56	3.2.03
M. Mather, 14 George Street, Wasleys, S.A. 5400	12.18	20.5.03
S. L. McGaffin, Lot 91, Blanchetown Road, Sedan, S.A. 5353	25.71	1.8.03
B. MacCulloch and D. Thiele, 25 Spriggs Street, Berri, S.A. 5343	102.36	18.8.03
D. G. Moyle, 42-44 Miller Street, Springton, S.A. 5235	36.27	26.2.03
M. McArdle, P.O. Box 646, Nuriootpa, S.A. 5355	71.33	10.1.05
S. Mitchell, 33 Chamberlain Road, Willaston, S.A. 5118	13.83	20.5.03
D. Novak, 79 Greenock Road, Nuriootpa, S.A. 5355	165.67	16.4.03
L. M. Nicol, 54 Para Road, Tanunda, S.A. 5352	119.93	29.4.03
A. S. Nelson, P.O. Box 211, Tarlee, S.A. 5411	148.35	10.3.03
M. D. Nykiel, 12 Auricht Avenue, Tanunda, S.A. 5352	102.40	29.11.03
S. Neil, 4 Hutchinson Road, Gawler East, S.A. 5118	96.90	31.5.04
S. M. O'Shaughnessy, P.O. Box 45, Sutherlands, S.A. 5374	15.56	29.4.03
N. A. Oates, P.O. Box 49, Goolwa, S.A. 5214	248.47	20.5.03
D. B. Pohl, Cambrai, S.A. 5353	37.38	15.8.03
D. H. Palfrey, 35 Bilyara Road, Tanunda, S.A. 5352	291.83	8.8.03
K. Paarde, P.O. Box 215, Kapunda, S.A. 5373	52.14	8.10.03
F. and K. Placanica, 2 Traeger Court, Tanunda, S.A. 5352	208.15	26.9.03
A. Phillips, 29 Sturt Street, Angaston, S.A. 5353	26.18	30.5.03
L. J. Piggins, 10 Florence Street, Hamley Bridge, S.A. 5401	63.22	26.12.03
J. Paulett, Unit 1, 7 Edward Street, Tanunda, S.A. 5352	59.98	1.7.03
J. H. and R. Payne, Unit 3, 27 Fourth Street, Gawler, S.A. 5118	22.47	19.1.04
M. A. Porter, 10 Gilding Street, Tanunda, S.A. 5352	104.59	1.5.03
R. Paterson, 11 Swales Place, Colyton, N.S.W. 2760	31.19	13.11.03
J. Payne, c/o Post Office, Swan Reach, S.A. 5354	26.49	16.4.03
K. Philippou, P.O. Box 584, Tanunda, S.A. 5352	14.60	8.8.03
J. E. and M. L. Prenzler, 40 Angas Street, Tanunda, S.A. 5352	12.22	2.11.03
R. and J. Perry, P.O. Box 19, Riverton, S.A. 5412	14.52	20.10.03
J. M. Rogers, Seppeltsfield, S.A. 5360	2 246.14	8.3.03
T. B. Richardson, 34 Gooden Drive, Nuriootpa, S.A. 5355	50.79	27.12.06
C. and K. Robertson, 3 Nannes Grove, Angaston, S.A. 5353	104.52	31.12.03
H. M. Reimers, P.O. Box 10, Angaston, S.A. 5353	80.06	22.1.07
J. P. Rowlands, 49 Para Road, Evanston, S.A. 5116	43.87	21.3.03
D. W. Robin, Unit 5, 4 Krieg Street, Nuriootpa, S.A. 5355	93.03	23.9.03
A. Reljich, 79 Oleander Drive, Parafield Gardens, S.A. 5107	68.60	3.3.03
L. J. Sheppard, c/o Post Office, Truro, S.A. 5356	142.71	2.1.07
D. D. Schultz, 34 Tolley Road, Nuriootpa, S.A. 5355	163.63	24.1.02
B. E. Stevens, 2C Mader Court, Nuriootpa, S.A. 5355	281.46	1.6.03
A. A. Schmidt, 28 McKinlay Avenue, Gawler East, S.A. 5118	92.21	23.12.03
W. Stewart, 52A Radford Road, Angaston, S.A. 5353	571.15	19.9.03
Sumsar Glass Designs, 16 John Dallwitz Avenue, Angaston, S.A. 5353	211.15	16.4.03
S. M. Simper and C. K. Brown, 5 Kapunda Street, Eudunda, S.A. 5374	193.61	19.7.04
H. E. Smith, c/o Post Office, Cockatoo Valley, S.A. 5351	12.47	12.12.03

Name and Address of Owner	Amount \$	Date
J. M. Sables, P.O. Box 555, Lyndoch, S.A. 5351	32.24	7.4.03
C. M. Starkey, 16 Blaxland Street, Nuriootpa, S.A. 5355	54.75	16.4.03
H. A. Sims, P.O. Box 662, Nuriootpa, S.A. 5355	10.49	2.12.02
A. J. Smith and M. A. Poulton, 48 High Street, Kapunda, S.A. 5373	32.63	24.8.01
R. Schierbeck, P.O. Box 21, Brinkworth, S.A. 5464	18.50	4.9.03
J. Shields, 1/22 Military Road, West Beach, S.A. 5024	38.05	1.6.03
K. L. Siebert, 1 Short Street, Tanunda, S.A. 5352	70.88	23.2.03
P. Smart, c/o 64 Seaford Road, Seaford, S.A. 5169	20.09	8.3.03
B. J. Schiller, 14/538 South Road, Kurraltia Park, S.A. 5037	17.87	23.12.03
A. Stevens, P.O. Box 657, Nuriootpa, S.A. 5355	19.83	26.2.03
L. and D. Silk, P.O. Box 217, Greenock, S.A. 5360	46.60	30.11.03
B. E. Turley, 2/1 Sobels Street, Tanunda, S.A. 5352	66.60	16.6.03
K. Trowell, P.O. Box 86, Sandy Creek, S.A. 5350	37.07	25.11.03
C. D. Thomas, 17 Twenty-Second Street, Gawler South, S.A. 5118	10.89	20.5.03
R. L. and M. K. Titterton, 18 Prider Street, Nuriootpa, S.A. 5355	44.01	22.9.03
L. Thomson, 17 Silcock Circuit, Greenwith, S.A. 5125	139.34	14.7.03
C. Tipler, 27 Clark Terrace, Angaston, S.A. 5353	21.88	28.8.03
J. Tunn, 1 Angas Street, Springton, S.A. 5235	28.86	11.6.03
P. A. Tilbrook, P.O. Box 39, Swan Reach, S.A. 5354	11.54	26.2.03
R. W. and E. P. Taylor, P.O. Box 118, Swan Reach, S.A. 5354	25.33	30.9.03
H. Talbot-Smith, 10 Second Avenue, Tanunda, S.A. 5352	17.69	25.2.04
R. C. and S. P. Wallis, P.O. Box 121, Sedan, S.A. 5353	104.10	27.7.03
J. M. Whellum, P.O. Box 28, Cadell, S.A. 5321	105.28	26.5.03
D. J. Whiteman, 28 Aughey Street, Tanunda, S.A. 5352	36.95	4.8.03
G. A. Warrington, 8 Stephens Avenue, Springvale, S.A. 3171	53.60	10.1.05
J. A. Wardle, P.O. Box 510, Kapunda, S.A. 5373	58.72	21.3.03
We Sell Music, Shop 3, 1 Murray Street, Nuriootpa, S.A. 5355	85.85	29.12.03
M. Weidenbach, 17 Silcock Circuit, Greenwith, S.A. 5125	22.11	11.11.02
A. Weigand, 30 Gunn Street, Eudunda, S.A. 5374	28.12	7.4.03
M. H. Way and C. M. Pisani, P.O. Box 356, Greenock, S.A. 5360	20.24	23.12.03
K. E. and J. S. Young, 28 Hanson Street, Freeling, S.A. 5372	117.86	29.4.03
B. M. Zilm, P.O. Box 57, Truro, S.A. 5356	694.17	22.10.03
J. P. Zeunert, 20 Tolley Road, Nuriootpa, S.A. 5355	11.21	16.6.03
L. and R. Zauch, 1686 Semaphore Road, Exeter, S.A. 5019	17.11	13.11.03
Total	19 419.01	

UNCLAIMED MONEYS ACT 1891

Register of Unclaimed Moneys held by Zurich Financial Services Australia Limited as at January 2010

Name of Owner	Total Amount Due to Owner \$	Description of Unclaimed Moneys	Date of Original Cheque
Alexia M. Taylor, 18 Catherine Street, Armidale, N.S.W. 2350	153.40	Claim settlement	11.6.03
Argerios Kikianis, 17 Westminster Street, Fulham Gardens, S.A. 5024	50.95	Claim settlement	29.12.00
D. E. Bruce, 2 Brickdale Crescent, Mount Osmond, S.A. 5064	274.65	Claim settlement	30.6.94
O. J. Burton, Mangalo via Cowell, S.A. 5602	86.75	Claim settlement	24.5.94
Cawgal Pty Ltd, 838 Port Road, Woodville, S.A. 5011	136.36	Carpet cleaning	25.2.02
Chicken Chef, 11 Elizabeth Way, Elizabeth, S.A. 5112	90.91	Refund of excess	25.6.02
A. Colmarr, 58 Ashley Street, Torrensville, S.A. 5031	647.26	Claim settlement	February 1993
I. Cook, 51 Standrews Crescent, Novaz Gardens, S.A. 5040	81.33	Claim settlement	9.1.93
Cristina Di Manno, 25 Loder Street, Glynde, S.A. 5070	24.70	Claim settlement	29.12.00
D. Turic, 32 Broad Street, Marden, S.A. 5070	77.26	Claim settlement	29.12.00
Damian Lalor, Unit 17/1 Waterside Drive, Dudley Park, W.A. 6210	103.54	Claim settlement	24.7.02
David G. Stevens, P.O. Box 180, Wentworthville, N.S.W. 2145	31.61	Claim settlement	29.12.00
David Gilfillian, 235 St Vincents Street, Port Adelaide, S.A. 5015	435.53	Claim settlement	18.6.01
DB Insurance, Level 1, 300 Flinders Street, Adelaide, S.A. 5000	71.00	Claim settlement	3.11.98
D. F. Wyatt, c/o WIP G.P.O. Box 274, Adelaide, S.A. 5001	137.65	Claim settlement	28.1.00
V. Digirolamo, 2/64A Second Avenue, St Peters, S.A. 5069	175.18	Claim settlement	27.8.93
D. K. Donald, 14 Scott Avenue, Barmera, S.A. 5342	114.86	Claim settlement	21.8.93
Donoto Rocca, 10 Hill Street, Campbelltown, S.A. 5074	11.71	Claim settlement	29.12.00
Thomas Payne (deceased estate), 2/42 Charlick Circuit, Adelaide, S.A. 5000	20.80	Claim settlement	13.12.00
Fairview Park, 15/35 Hancock Road, Fairview Park, S.A. 5126	91.88	RP for cancellation	5.7.94

Name of Owner	Total Amount Due to Owner \$	Description of Unclaimed Moneys	Date of Original Cheque
For Sing Chan, c/o 11 Pellew Avenue, Auldana, S.A. 5072.	15.53	Claim settlement	29.12.00
G. Swift and T. Buckler, 36 Rau Avenue, Evanston, S.A. 5116	82.51	Claim settlement	1.3.97
M. Gilbert, 581 Port Road, Croydon, S.A. 5008	143.90	Claim settlement	28.9.93
Hamerose Pty Ltd, 1-8 Wakefield Street, Kent Town, S.A. 5067	395.14	Commission Cheque	26.9.97
K. Heikkonen, 6 Ramsgate Street, Glenelg, S.A. 5045	188.27	Claim settlement	17.2.94
M. Hill, 63 Montague Road, Poorak, S.A. 5095	67.81	Claim settlement	3.2.94
D. Jewitt, 28 John Street, Eastwood, S.A. 5063	181.09	Claim settlement	3.11.94
Kathleen Benson, 17 Wellington Street, Glandore, S.A. 5037	16.71	Claim settlement	29.12.00
Klaus and Connie Ebdrup, 5 Pengara Avenue, Hawthorndore, S.A. 5051	106.93	Claim settlement	2.2.96
Lachlan Reeks, 14A John Fisher Drive, Torrens Park, S.A. 5062	21.46	Claim settlement	29.12.00
Laminex Group, sent c/o Wark & Partners	4 464.80	Refund for third party damage	12.12.03
C. Lee and S. Brambi, 25 Peera Street, Hallett Cove Estate, S.A. 5158	148.68	Claim settlement	13.1.94
Liam Cahill, 64 Brighton Road, Glenelg East, S.A. 5045	358.26	Claim settlement	11.6.03
Mary Joan Smith, 19 Revell Street, Port Pirie, S.A. 5540	26.26	Claim settlement	21.8.99
J. S. McFarland, 503 Yatalavale Road, Fairview Park, S.A. 5162	120.45	Claim settlement	12.4.94
Peter R. Schulze, P.O. Box 143, Brooklyn Park, S.A. 5032.	29.09	Claim settlement	15.3.01
N. Pengelly, 42 Ulinga Street, Glenlegh	50.00	Claim settlement	17.11.94
Nicole Investments Pty Ltd, P.O. Box 221, Glen Osmond, S.A. 5064	32.35	Claim settlement	22.12.00
N. R. Pengelly, 42 Ulinga Street, Glenelg North, S.A. 5045	100.00	Claim settlement	8.11.94
P. H. Nicholls, G.P.O. Box 3070, Brisbane, Qld 4001	88.88	Claim settlement	1.2.96
Pizza Haven Erindale, 5/38 Gartside Avenue, Erindale, S.A. 5066	500.00	Refund of excess	6.9.02
Pizza Haven Morningside, 629 Wynnum Road, Morningside, Qld 4170	1 060.00	Burglary claim	26.3.02
Pizza Haven Morningside, 629 Wynnum Road, Morningside, Qld 4170	852.95	Money claim	26.3.02
Pizza Haven Morningside, 629 Wynnum Road, Morningside, Qld 4170	230.45	Glass claim	26.3.02
P. A. Powett, 27/104 West Lakes Boulevard, West Lakes, S.A. 5021	161.07	Claim settlement	February 1993
P. W. and J. A. Godden, 56 Jane Street, Willaston, SA, 5118	148.54	Claim settlement	2.8.96
Quality Wine Merchants, 128-134 Gilbert Street, Adelaide, S.A. 5000	289.37	Refund of cancellation	8.5.03
R. and C. Gynell, P.O. Box 143, Brooklyn Park, S.A. 5032	11.44	Claim settlement	29.12.00
R. B. and C. C. Rowan, 12 Seaview Road, Lynton, S.A. 5062	85.50	Claim settlement	29.12.00
W. V. Secker, 1 Maluka Drive, Happy Valley, S.A. 5159 ...	230.47	Claim settlement	22.6.94
STR Corp 11183 Inc., c/o Graham Buesnel, 12 Sutherland Avenue, Semaphore Park, S.A. 5019	20.57	Claim settlement	25.7.01
A. Stranz, P.O. Box 94, Crafers, S.A. 5152	130.00	Claim settlement	14.4.94
Themis Tsogas, 8/32 Boord Street, Semaphore South, S.A. 5019	23.85	Claim settlement	29.12.00
Ting Cheng, 17 Pellew Avenue, Auldana, S.A. 5072	94.67	Claim settlement	18.6.01
M. Trant, P.O. Box 126, Kingscote, S.A. 5223	500.00	Claim settlement	17.7.93
Vito Spadavecchia, 42 Church Circle, Port Pirie, S.A. 5540	13.63	Claim settlement	29.12.00
W. A. and N. J. Lewis, 17B Rosedale Avenue, Morphet Vale, S.A. 5162	94.97	Claim settlement	1.2.96

ATTENTION

CUSTOMERS requiring a proof of their notice for inclusion in the *Government Gazette*, please note that the onus is on you to inform **Government Publishing SA** of any subsequent corrections by **10 a.m. on Thursday**, which is our publication deadline.

For any corrections to your notice please phone 8207 1045 or Fax 8207 1040 **before** 10 a.m. on Thursday.

If we do not receive any communication by 10 a.m. on Thursday (day of publication) we will presume the notice is correct and will print it as it is.

Remember—the onus is on you to inform us of any corrections necessary to your notice.

NOTE: Closing time for lodging new copy (electronically, fax or hard copy) is 4 p.m. on Tuesday preceding the day of publication. Phone 8207 1045—Fax 8207 1040.

Email: governmentgazette@dpc.sa.gov.au