



Victoria Government Gazette

No. G 32 Thursday 8 August 2002

GENERAL

GENERAL AND PERIODICAL GAZETTE

Copy to: Gazette Officer
The Craftsman Press Pty. Ltd.
125 Highbury Road,
Burwood Vic 3125
Telephone: (03) 9926 1233
Facsimile: (03) 9926 1292
DX: 32510 Burwood
Email: gazette@craftpress.com.au

Advertising Rates and Payment

All prices include GST

Private Notices

Payment must be received in advance with advertisement details.

33 cents per word – Full page \$198.00.

Additional costs must be included in prepayment if a copy of the gazette is required. Copy Prices – Page
\$1.65 – Gazette \$3.52 – Certified copy of Gazette \$3.85
(all prices include postage). **Cheques should be made payable to The Craftsman Press Pty. Ltd.**

Government and Outer Budget Sector Agencies Notices

Not required to prepay.

Advertisements may be faxed or sent via email with a cover sheet, marked to the attention of the Gazette Officer. Floppy Disks (Mac & PC) can also be accepted.

Costs can be calculated on the following basis:

Per Line	Typeset
Single column	\$1.71
Double column	\$3.41
Full Page	\$71.28

The Craftsman Press is pleased to offer a series of discounts from the typesetting costs.

1. Copy supplied on disk.
2. Copy supplied via email.
3. Artwork for forms and other material which require exact reproduction.

1. Copy supplied on disk.

Where a disk is supplied and there is minimum alteration required, **30% off.**

Where a disk is supplied requiring extraneous matter stripped out and styles applied, **20% off.**

2. Copy supplied via email.

Where a notice is sent via email and there is minimum alteration required, **25% off.**

Where email is supplied requiring extraneous matter stripped out and styles applied, **15% off.**

3. Artwork for forms and other material which requires exact reproduction.

Scanning and sizing of artwork for forms, to be reproduced in page format, **35% off.**

Copy Deadline for General Gazette

9.30 a.m. Monday – (Private Notices)

9.30 a.m. Tuesday – (Government and Outer Budget Sector Agencies Notices)

Advertisers should note:

- Late copy received at The Craftsman Press Pty. Ltd. after deadlines will be placed in the following issue of VGG, irrespective of any date/s mentioned in the copy (unless otherwise advised).
- Late withdrawal of advertisements (after client approval, before printing) will incur 50 per cent of the full advertising rate to cover typesetting, layout and proofreading costs.
- Proofs will be supplied only when requested or at the direction of the Gazette Officer.
- No additions or amendments to material for publications will be accepted by telephone.
- Orders in Council may be lodged prior to receiving assent with the Governor's or Clerk's signature. They will only be published once approved and signed.
- Accounts over 90 days will be issued with a letter of demand.
- Government and Outer Budget Sector Agencies please note: *See style requirements on back page.*

SPECIAL GAZETTES

Copy to: Gazette Officer
The Craftsman Press Pty. Ltd.
125 Highbury Road
Burwood Vic 3125
Telephone: (03) 9926 1233
Facsimile: (03) 9926 1292
Email: gazette@craftpress.com.au

Advertising Rates and Payment

Private Notices

Full Page \$396.00

Payment must be received in advance with notice details.

Government and Outer Budget Sector Agencies Notices

Full Page
Typeset
\$96.25

Note:

The after hours number for Special Gazettes is:
Telephone: 0419 327 321

SUBSCRIPTIONS AND RETAIL SALES

Copies of the *Victoria Government Gazette* can be purchased from The Craftsman Press Pty. Ltd. by subscription.

The *Victoria Government Gazette*

General and Special – \$187.00 each year

General, Special and Periodical – \$249.70 each year

Periodical – \$124.30 each year

Subscriptions are payable in advance and accepted for a period of one year. All subscriptions are on a firm basis and refunds will not be given.

All payments should be made payable to The Craftsman Press Pty. Ltd.

Subscription enquiries:

The Craftsman Press Pty. Ltd.
125 Highbury Road, Burwood Vic 3125
Telephone: (03) 9926 1233

INDEX TO PRIVATE ADVERTISERS

A

Armstrong Ross	1917
Arthur J. Dines & Co.	1917
Aughtersons	1917

B

Borchard & Moore	1917
------------------------	------

D

Dwyer Mahon & Robertson	1917
-------------------------------	------

F

Featherby's	1918
Frederick Owen & Associates Pty Ltd ..	1918

G

Garden & Green	1918
----------------------	------

M

Michael R. Nolan	1918
------------------------	------

R

Riccioni & Greenwood	1918
Rogers & Every	1919

S

Stidston & Williams Weblaw	1919
----------------------------------	------

T

Trust Company of Australia Limited ...	1919
--	------

PRIVATE ADVERTISEMENTS

Re: Estate of NANCY CHARLOTTE CROOKS, deceased. Creditors, next-of-kin or others having claims in respect of the estate of NANCY CHARLOTTE CROOKS, late of Hillside Lodge, Bridge Street, Korumburra, widow, deceased, who died on 8 November 2001, are to send particulars of their claims to the executor care of the undermentioned solicitors by 20 October 2002 after which date the executor will distribute the assets having regard only to the claims of which he then has notice.

ARMSTRONG ROSS, barristers & solicitors,
Suite 1, 1693A Burwood Highway, Belgrave.

ANTONIO RAFAELE CARDAMONE, late of 66 Alexander Avenue, Thomastown, in the State of Victoria, pensioner, deceased. Creditors, next-of-kin and others having claims in respect of the estate of the deceased, who died on 11 February 2002, are required by the executrices, Maria Christina Cardamone and Carly Murphy (formerly Acciarito), care of Arthur J. Dines & Co., solicitors, 2A Highlands Road, Thomastown, in the said State, to send particulars to them by 12 October 2002 after which date the executrices may convey or distribute the assets having regard only to claims of which they have notice.

Dated 1 August 2002.

ARTHUR J. DINES & CO., solicitors,
2A Highlands Road, Thomastown 3074.

CATERINA NARDELLA, late of Coronella Nursing Home, 163-165 Central Road, Nunawading, widow, deceased. Creditors, next-of-kin and others having claims in respect of the estate of the abovenamed deceased, who died on 23 March 2002, are required by the executors, Tony Nardella of 20A Vista Avenue, Ringwood East, Carolina Guerra of 10 Bolac Street, Bayswater and Luigino Nardella of 4 Darvall Street, Doncaster, to send particulars thereof to them care of the office of Messrs Aughtersons, 267 Maroondah Highway, Ringwood, within sixty days from the date of publication of this notice, after which the executors will distribute the estate having regard only to the claims of which they have notice.

AUGHTERSONS, solicitors for the executors,
267 Maroondah Highway, Ringwood 3134.

Re: MABEL WOOD MILLAR, late of George Vowell Centre, Cobb Road, Mount Eliza, Victoria, but formerly of 22 Belford Street, St. Kilda, Victoria, home duties, deceased. Creditors, next-of-kin and others having claims in respect of the estate of the deceased, who died on 14 November 2001, are required by the trustee, Gordon Francis Henry William Millar, (in the will called Francis Henry William Gordon Millar) of 35 Richard Drive, Langwarrin, Victoria, retired, the brother, to send particulars to the trustee by 25 October 2002 after which date the trustee may convey or distribute the assets, having regard only to the claims of which the trustee has notice.

BORCHARD & MOORE, solicitors,
44 Douglas Street, Noble Park 3174.

Re: Estate of HENRY GEORGE BROAD, deceased. Creditors, next-of-kin or others having claims in respect of the estate of HENRY GEORGE BROAD, late of Woomelang in the State of Victoria, farmer, deceased, who died on 17 August 2001, are to send particulars of their claim to the administrator care of the undermentioned legal practitioners by 31 October 2002 after which date the administrator will distribute the assets having regard only to the claims of which he then has notice.

DWYER MAHON & ROBERTSON,
legal practitioners,
Beveridge Dome,
194-208 Beveridge Street, Swan Hill.

Re: Estate of BARBARA JEAN KNIGHTS deceased. Creditors, next-of-kin or others having claims in respect of the estate of BARBARA JEAN KNIGHTS, late of 9 Brooke Street, Woomelang, in the State of Victoria, retired business proprietor, deceased, who died on 11 September 2000, are to send particulars of their claim to the executor care of the undermentioned legal practitioners by 23 October 2002 after which date the executor will distribute the assets having regard only to the claims of which he then has notice.

DWYER MAHON & ROBERTSON,
legal practitioners,
Beveridge Dome,
194-208 Beveridge Street, Swan Hill.

Estate of YVONNE MAVIS LEHMANN, deceased. Creditors, next-of-kin or others having claims in respect of the estate of YVONNE MAVIS LEHMANN, late of 1/66 Doveton Avenue, Eumemmering, in the State of Victoria, deceased, who died on 9 September 2001, are to send particulars of their claims to the executor care of the undermentioned solicitors by 7 October 2002 after which date the executor will distribute the assets having regard only to the claims of which he then has notice.

FEATHERBY'S, solicitors,
1043A Point Nepean Road, Rosebud 3939.

Re: HAROLD GORDON TULLOCH, deceased. Creditors, next-of-kin and others having claims in respect of the estate of HAROLD GORDON TULLOCH, late of Twin Parks Hostel, 47 Blake Street, Reservoir, Victoria, retired, deceased, who died on 2 February 2002, are required to send particulars of their claims to the executors, Betty Agnes Edmonds of 28 Michael Street, Lalor, Victoria, pensioner and Thomas Clayton Tulloch of 39 Goldsmith Avenue, Preston, Victoria, retired, by 11 October 2002 after which date the executors may convey or distribute the assets having regard only to the claims of which the trustee then has notice.

FREDERICK OWEN &
ASSOCIATES PTY LTD,
55-57 Cardigan Place, Albert Park.

Re: LILLIAS ISABEL HUGHES, late of Unit 6, 110 Stradbroke Avenue, Swan Hill, Victoria, home duties, deceased. Creditors, next-of-kin and others having claims in respect of the estate of the deceased, who died on 11 May 2002, are required by the trustees, Kenneth Henry Rinaldi and Trevor John Rinaldi, to send particulars to them by 16 October 2002 after which date the trustees may convey or distribute the assets, having regard only to the claims of which they then have notice.

GARDEN & GREEN, solicitors,
4 McCallum Street, Swan Hill 3585.

Re: MARJORIE HILDA MASON, late of Aged Care Facility, 14 Alfred Place, Strathalbyn, South Australia, widow, deceased. Creditors, next-of-kin and others having claims in respect of the estate of the deceased, who died on 13 March 2002, are required by the trustees,

Ross David Mason, Julie Carolyn Hotton and Christine Cheryl Fowler, to send particulars to them by 16 October 2002 after which date the trustees may convey or distribute the assets, having regard only to the claims of which they then have notice.

GARDEN & GREEN, solicitors,
4 McCallum Street, Swan Hill 3585.

Creditors, next-of-kin or others having claims in respect of the estate of HUBERT WILLIAM COFFEY, late of Unit 23, Hawthorn Avenue, Caulfield North 3161, Victoria, retired minister of religion, who died on 13 May 2002, are to send particulars of their claims to the executrix care of the undermentioned solicitor by 30 October 2002 after which date she will distribute the assets having regard only to the claims of which she then has notice.

MICHAEL R. NOLAN, solicitor,
689 Whitehorse Road, Mont Albert 3127.

Re: MARJORIE LYDIA DUCK, late of Walmsley Hostel, apartment 249, 133 Greeves Drive, Kilsyth, farmer, deceased. Creditors, next-of-kin and others having claims in respect of the estate of the deceased, who died on 23 May 2002, are required by the executors, Marjorie Elizabeth Major and Ronald James Duck to send particulars to the executors by 9 October 2002 after which date the executors may convey or distribute the assets, having regard only to the claims of which the executors have notice.

RICCIONI & GREENWOOD, solicitors,
142 Main Street, Lilydale 3140.

Re: ALICE MAVIS GRUMMETT, late of 9 Campbell Street, Bentleigh, Victoria, home duties, deceased. Creditors, next-of-kin and others having claims in respect of the estate of the deceased, who died on 9 April 2002, are required by the trustee, Brian Marshall Grummett of 9 Campbell Street, Bentleigh, Victoria, son, to send particulars to the trustee by 9 October 2002 after which date the trustee may convey or distribute the assets, having regard only to the claims of which the trustee has notice.

RICCIONI & GREENWOOD, solicitors,
Incorporating Eales & Mackenzie, (Lilydale),
142 Main Street, Lilydale 3140.

Re: THOMAS WILLIAM JONES, late of 18 Batten Street, California Gully, retired, deceased. Creditors, next-of-kin and others having claims in respect of the estate of the deceased, who died on 29 May 2002, are required by the trustees, Raymond Clarence Jones of 5 Aviator Place, Melton South and Gary Linsay Jones of 12 Barkly Street, Wahgunyah, to send particulars to the trustees care of the undermentioned legal practitioners by 7 October 2002 after which date the trustees may convey or distribute the assets having regard only to the claims of which the trustees have notice.

ROGERS & EVERY, legal practitioners,
71 Bull Street, Bendigo.

Re: GLADYS ELVA MOLE, late of Bethany Hostel, 440 Camberwell Road, Camberwell, retired trained nurse, deceased. Creditors, next-of-kin and others having claims in respect of the estate of the deceased, who died on 12 April 2002, are required by the trustees, Harold Bruce Every of 27 McCallum Road, Doncaster and Daryl Thomas Watts of 12 Hillary Court, Bendigo, to send particulars to the trustees care of the undermentioned legal practitioners by 7 October 2002 after which date the trustees may convey or distribute the assets having regard only to the claims of which the trustees have notice.

ROGERS & EVERY, legal practitioners,
71 Bull Street, Bendigo.

EWART MAXWELL ACKROYD, late of 56 Banksia Place, Rosebud, Victoria, deceased. Creditors, next-of-kin and others having claims in respect of the estate of the deceased, who died on 5 June 2002, are required by the trustee, Elsie May Ackroyd of 56 Banksia Place, Rosebud, Victoria, to send particulars to her by 14 October 2002 after which date the trustee may convey or distribute the assets, having regard only to the claims of which she then has notice.

STIDSTON & WILLIAMS WEBLAW,
solicitors,
313 Main Street, Mornington.

Creditors, next-of-kin and others having claims in respect of the estate of JULIET MERYON DOUGLAS, late of Helen Schutt Nursing Home, Sloane Street, Stawell, in the State of Victoria, home duties, deceased, who died on 29 March 2000, are to send particulars

of their claims to the executor by 11 October 2002 after which date the executor will distribute the assets of the estate having regard only to the claims of which it then has notice.

TRUST COMPANY OF AUSTRALIA
LIMITED,
151 Rathdowne Street, Carlton South,
Victoria 3053.

In the Supreme Court of the State of Victoria
SALE BY THE SHERIFF

On Thursday 12 September 2002 at 11.00 a.m. at the Sheriff's Office, Court Complex, Faithful Street, Wangaratta, (unless process be stayed or satisfied).

All the estate and interest (if any) of Gerald James Thompson of 35 Bridge Street, Beechworth, as shown on Certificate of Title as Gerard James Joseph Thompson, proprietor of an estate in fee simple in One of a total of Four equal undivided shares registered as Tenants in Common with Barry Frederick Anthony Thompson as to One of a total of Four equal undivided shares, Brian George Thompson (legal personal representative of the late Gerald James Patrick McHugh) as to One of a Total of Four equal undivided shares, Brian George Thompson as to One of a total of Four equal undivided shares and being the land described on Certificate of Title Volume 9910, Folio 032 upon which is erected a dwelling known as 35 Bridge Street, Beechworth.

Registered Mortgage Nos. T931577Q, AB022582V and Caveat No. W931250J affect the said estate and interest.

Terms – Cash only

SW-02-004229-9

Dated 8 August 2002

V. PARKIN
Sheriff's Office

In the Supreme Court of the State of Victoria
SALE BY THE SHERIFF

On Wednesday 11 September 2002 at 2.30 p.m. at the Sheriff's Office, 8–20 King Street, Oakleigh, (unless process be stayed or satisfied).

All the estate and interest (if any) of Kevin F. Stewart of 11 Marlborough Street, East Bentleigh, as shown on Certificate of Title as

Kevin Frederick Stewart, joint proprietor with Elizabeth Irene Stewart of an estate in fee simple in the land described on Certificate of Title Volume 8121, Folio 819 upon which is erected a house known as 11 Marlborough Street, East Bentleigh.

Registered Covenant No. A167452 affects the said estate and interest.

Terms – Cash/Eftpos
(Debit Card Only. No Credit Cards).

SW-02-004410-3

Dated 8 August 2002

V. PARKIN
Sheriff's Office

In the County Court of the State of Victoria

SALE BY THE SHERIFF

On Wednesday 11 September 2002 at 2.30 p.m. at the Sheriff's Office, 8–20 King Street, Oakleigh, (unless process be stayed or satisfied).

All the estate and interest (if any) of Athena Goulos of 28 Sterling Road, East Keilor, proprietor of an estate in fee simple in the land described on Certificate of Title Volume 10276, Folio 476 upon which is erected a dwelling known as 5 Stroner Avenue, East Keilor.

Registered Mortgage No. W235335F, Covenant in Instrument No. U148820A and Agreement Section 173, No. T938784P affect the said estate and interest.

Terms – Cash/Eftpos
(Debit Card Only. No Credit Cards).

CW-01-012193-4

Dated 8 August 2002

V. PARKIN
Sheriff's Office

Unclaimed Moneys Act 1962

Register of Unclaimed Moneys held by the —

<i>Name of Owner on Books and Last Known Address</i>	<i>Total</i>		<i>Date</i>
	<i>Amount</i>	<i>Description</i>	<i>when</i>
	<i>Due to</i>	<i>Of Unclaimed</i>	<i>Amount</i>
	<i>Owner</i>	<i>Money</i>	<i>first</i>
			<i>became</i>
			<i>Payable</i>
GARRY MASCHLER FIRST NATIONAL PTY. LTD.			
	\$		
Seang Din	100.00	Cheque	17/06/93
Singh Jaswant and Sarbjeet Kaur Singh, 10 Page Close, Noble Park.	150.00	"	23/05/95
Gentile Pty Ltd, Lysterfield	100.00	"	09/06/95
A. A. Group, 4 Prestige Drive, Clayton South	100.00	"	24/06/95
Mr. Do Huu Nguyen, 2/67 Albert Avenue, Springvale.	100.00	"	27/06/95

Lai Nguyen, 15 Vardon Street, Springvale	100.00	”	02/07/97
Lion San Lam, 21 Fletcher Road, Dandenong	100.00	”	31/12/96
Huong Thi My Hoang, 1079 Heatherton Road, Noble Park	100.00	”	02/07/01
Mr. Sothy, 6 Terry Court, Springvale South	141.51	”	26/02/99

02227

CONTACT: MS. SUZANNE MASCHLER, PHONE: (03) 9558 5999.

Unclaimed Moneys Act 1962

Register of Unclaimed Moneys held by the —

<i>Name of Owner on Books and Last Known Address</i>	<i>Total Amount Due to Owner</i>	<i>Description Of Unclaimed Money</i>	<i>Date when Amount first became Payable</i>
TELECOM BONDS			
	\$		
Gwendolyn Alma Smith, 5 Bream Close, Nelson Bay, NSW	14,786.72	Cheque	17/07/00
Robert A. B. Cook, Mar Lodge, Bandarawela, Sri Lanka	10,000.00	”	”
Richard Leonard Woodard & Neita Alice Woodard, 34 Crowther Street, Geraldton, WA	2,231.29	”	”
Joyce Georgeana Davies, 4 Seabreeze Street, Grange, SA	26,000.00	”	”
Ian Rowland Hope, 31 Gray Street, Hamilton	1,035.00	”	15/04/00
Celia M. A. Skylovsky, 69 Prospect Hill Rd, Camberwell	587.50	”	01/05/00
Ian Rowland Hope, 31 Gray Street, Hamilton	1,035.00	”	15/10/00
Paper Agencies (Aust) Pty Ltd, A/c Supn Fund, 554 Burwood Road, Hawthorn	14,375.00	”	”
Celia M. A. Skylovsky, 69 Prospect Hill Rd, Camberwell	587.50	”	01/11/00
Violet Linda Vernon, 24 Davis Street, Kew	134.38	”	01/02/01
Eric White & Lois White, 66 Dunham Street, Rye	1,590.84	”	17/04/00
G. & G. Iudica Pty Ltd, PO Box 331, Robinvale	11,106.21	”	”
Hamish John Cowan, PO Box 1094A, Sydney South, NSW	7,393.36	”	17/07/00
Janet Thistlethwaite, 4/15 James Street, Dandenong	5,000.00	”	”
Pamela Joy Harrison, 16 Ovens Street, North Box Hill	2,000.00	”	”

02145

CONTACT: TELECOM BONDS, PHONE: 1800 805 050.

Unclaimed Moneys Act 1962

Register of Unclaimed Moneys held by the —

<i>Name of Owner on Books and Last Known Address</i>	<i>Total Amount Due to Owner</i>	<i>Description Of Unclaimed Money</i>	<i>Date when Amount first became Payable</i>
TELSTRA CORPORATION LIMITED			
	\$		
M. C. Savannah	165.00	Cheque	30/06/99
N. Guidotti	480.99	"	28/07/99
K. A. Mellis	149.10	"	26/05/99
L. Mumby	295.05	"	03/03/99
L. Mumby, C/o Cheryl Aspery, Locked Bag 2121, Box Hill	166.95	"	17/03/99
A. G. C. (C/- Larry Noble & Assoc)	225.00	"	24/11/99
Mr Alexander Tjondrowidjojo, Jl Raya 94 Babat, Jawa Timur	176.04	"	13/01/95
Mr Hideki Okina, 305/1249-2 Nishisubara, Yonago, Japan	154.30	"	03/02/95
Mr Daisuke Sakai Nishikojiya, 1-21-11 Otaku Tokyo 144 Japan	410.79	"	07/03/95
Ms Masako Hamoto, 3/303 Aoyama 3/1 Nara City	199.85	"	28/04/95
Mr Yasunari Imasu, 69 Jaike Hiratacho Kaizugun Gifu	366.48	"	"
Mr Jan Gerber, Hirschberger, Allee 41, 68526 Landengurg	230.56	"	03/05/95
Optimum Software Technologies, 71-73 Thistlephwatte Street, South Melbourne	108.95	"	12/05/95
Miss Kaori Tsujimishi, 1-5-19 Hagikigaoka-Nishi Habikinu, Osaka	347.00	"	23/05/95
Mr Fred Dale Johnson, 21 South Venice Blvde #4 Venice	100.01	"	"
Miss Suzanna Cucu, W. Jaya 1 7 Jakarta	105.62	"	"
Mr Nicholas Moreau, 2 Rue De Lacroix De Craies 94000 Cregil	135.30	"	03/08/95
Miss Connie Ngu Liong Kung, 21 Repok Rd 96100 Sarikei	414.95	"	11/08/95
Mr Thor Hansen, C/- 58 Mannsverk, Norway	102.83	"	20/10/95
Negio Travel Pty Ltd, PO Box 753R, Melbourne	1,812.37	"	05/03/99
Mrs S. Long, 61A Burke Road, Clayton South	317.10	"	12/03/99
Ventile Holdings Pty Ltd, 548 City Rd, South Melbourne	159.31	"	25/03/99
Mr K. A. Gleeson, 443 Cardigan Street, Carlton	133.36	"	26/03/99
Mrs C. L. Alexander, 47 Wales St, West Footscray	114.40	"	31/03/99
H. & D. Group Pty Ltd, 5 Macbeth St, Braeside	437.15	"	26/04/99
Mr Paul White, 463 Raglan Pde, Warrnambool	156.00	"	27/04/99
Mrs S. C. Legaspi, Bacoor Cavite, Philippines	129.77	"	06/05/99
Miss S. Atchia, 99 Alma Road, St Kilda East	111.65	"	03/06/99
Westfield Shopping Centre Mgmt, Magic Drive, Fountain Gate	275.00	"	19/07/99
City of Casey, PO Box 1000, Narre Warren	280.00	"	11/02/00
Karen Inglis, 60 Vincent Street, Cessnock	140.00	"	06/11/98
Myer Stores Ltd, 25 McCrae Street, Dandenong	110.00	"	10/09/98
Coles Myer Pty Ltd, 5/295 Lonsdale St, Melbourne	275.00	"	30/09/98
Radio Parts Australia, 1097-1103 Dandenong Road, East Malvern	275.00	"	21/12/98
Dive Under, 49 Peninsula Avenue, Rye	110.00	"	27/01/99

Daimaru Australia Pty Ltd, 211 Latrobe Street, Melbourne	110.00	''	02/03/99
Australasian Corrosion Assoc., PO Box 2340, Mt Waverley	100.00	''	23/04/99
Myer Stores Ltd, Level 4, Midtown Plaza, Melbourne	550.00	''	15/06/99
Myer Stores Ltd, 25 McCrae Street, Dandenong	275.00	''	15/11/99
St Johns First Aid Services, 98 York St, South Melbourne	135.00	''	15/02/00
Leigh Martin Marine, 59-61 Thomas Mitchell Drive, Wodonga	275.00	''	01/03/00
Lorbach & Rye, 82 Albion Street, East Brunswick	215.00	''	31/07/98
Youth With A. Mission, 1 Kent Road, Surry Hills	1,910.00	''	30/10/98
Mini Supermarket, 365 Lygon Street, East Brunswick	622.00	''	25/06/99
Phoenix Colour Studio, 2050 Whitehorse Plaza Shpg Centre, Box Hill	147.90	''	29/10/99
Aust Communications Authority, PO Box 13112, Law Courts	3,151.00	''	26/08/99
Myer Stores Ltd, 1341 Dandenong Road, Chadstone	110.00	''	10/07/98
Bunnings Hardware, Riggall Street, Broadmeadows	110.00	''	17/06/99
Bunnings Warehouse, 3 Nepean Hwy, Mentone	275.00	''	18/06/99
North Melbourne Lotto, 25 Errol Street, North Melbourne	275.00	''	''
City Software Pty Ltd, PO Box 697, Mount Waverley	110.00	''	''
Myer Stores Ltd, Level 4, Midtown Plaza, Melbourne	110.00	''	22/06/99
Allen Brothers Jewellers, 201 Stuart Street, Ballarat	275.00	''	30/06/99
Myer Knox, Cnr Stud Rd & Burwood Hwy, Wantirna	275.00	''	05/07/99
Promech Automotive Services P/L, Factory 3-12 Laser Drive, Rowville	110.00	''	''
K-Mart Australia Pty Ltd, PO Box 350, Glen Iris	110.00	''	24/09/99
Northside Angler, 530 Mahoneys Road, Campbellfield	275.00	''	09/07/99
Scitec Australia Pty Ltd, 13th Floor, 114 Albert Road, Sth Melbourne	1,163.00	''	02/10/98
The Optical Shop, Shop 38A, Brandon Pk Shopping Centre, Mulgrave	110.00	''	24/11/98
Paul Dutta – Telstra Float, Shop K11/2-50, Murray Road, Preston	300.00	''	25/11/98
Myer Stores Ltd, 2/246 Bourke Street, Melbourne	110.00	''	16/12/98
Australia Post, GPO Box 72B, Melbourne	320.00	''	04/06/99
Myer Direct, PO Box 1000, MDC, Melbourne	110.00	''	11/06/99
Downtown Duty Free Pty Ltd, Tullamarine Airport, Melbourne	275.00	''	''
Myer Stores Ltd, Level 4, Midtown Plaza, Melbourne	110.00	''	''
Myer Stores Ltd, Level 4, Midtown Plaza, Melbourne	550.00	''	22/06/99
Harvey Norman, 169 Rosamont Road, Maribyrnong	275.00	''	25/08/99
Williamstown Bay & River Cruise, PO Box 196, Williamstown	1,267.00	''	04/10/99
Core Option Pty Ltd, 13/35 Collins Street, Melbourne	120.00	''	09/12/99
Angus & Robertson Bookworld P/L, GPO Box 82A, Melbourne	300.00	''	17/07/98
TN & AJ Walsh, Chappel-Vale, Kennedys Creek	350.00	''	24/07/98
Angus & Robertson Bookworld P/L, GPO Box 82A, Melbourne	150.00	''	04/09/98
Rosemary McIndoe, 395 Station Street, North Carlton	100.00	''	25/09/98
Australian Society of CPA's, P.D. Dept, 170 Queen Street, Melbourne	225.00	''	30/10/98
Mayne Nickless Ltd, 390 St Kild Road, Melbourne	247.53	''	06/11/98
Mayne Nickless Ltd, 390 St Kild Road, Melbourne	247.44	''	27/11/98

Mayne Nickless Ltd, 390 St Kild Road, Melbourne	381.59	''	18/12/98
Mutual Community Ltd, 23/35 Collins Street, Melbourne	1,220.57	''	''
E. P. Morrissey & Co Pty Ltd, 46 Bourke St, Braybrook	11,025.00	''	''
Mutual Community Ltd, 23/35 Collins Street, Melbourne	1,191.52	''	29/01/99
National Mutual Life (Voice), 23/35 Collins Street, Melbourne	1,834.30	''	''
National Mutual Life (Voice), 23/35 Collins Street, Melbourne	2,076.38	''	12/02/99
Mutual Community Ltd, 23/35 Collins Street, Melbourne	2,393.29	''	''
Gypsy's Gourmet, 480 Bourke Street, Melbourne	320.00	''	26/02/99
Peter John Downes, PO Box 21, St James	225.00	''	26/03/99
BHP Information Systems, 23/35 Collins Street, Melbourne	200.00	''	16/04/99
Australia Post, GPO Box 2020S, Melbourne	320.00	''	''
Victorian Roads Corp, 4th Floor, 595 Lygon St, Melbourne	278.00	''	11/06/99
Australian Society of CPA's, P.D.Dept, 170 Queen Street, Melbourne	170.00	''	25/06/99
Director Windgrass Pty Ltd, 30 Jellico Ave, Tallangatta	300.00	''	25/06/99
Secure Parking Pty Ltd, 11/180 Russell Street, Melbourne	391.00	''	02/07/99
Mutual Community Ltd, 23/35 Collins Street, Melbourne	2,085.82	''	16/07/99
E. E. Henderson, C/- Post Office, Toorloo Arm	270.00	''	23/07/99
Mutual Community Ltd, 23/35 Collins Street, Melbourne	2,002.26	''	13/08/99
David McKenzie, RMB 1580, Hordenvale	100.00	''	27/08/99
Public Transport Corporation, 10/589 Collins Street, Melbourne	10,000.00	''	''
La Trobe University Union, C/- La Trobe University, Bundoora	1,286.46	''	03/09/99
Mutual Community Ltd, 23/35 Collins Street, Melbourne	1,887.78	''	17/09/99
Mayne Nickless Ltd, 390 St Kild Road, Melbourne	931.62	''	15/10/99
Dept Natural Resources & Environment, Locked Bag 3000, Box Hill	10,000.00	''	22/10/99
Victorian Rail Track, Level 17, 589 Collins St, Melbourne	10,300.00	''	''
Mayne Nickless Ltd, 390 St Kild Road, Melbourne	987.35	''	19/11/99
Department of Conservation, 7 Service Street, Bairnsdale	250.00	''	26/11/99
Department of Conservation, PO Box 269, Orbost	3,000.00	''	''
Dept of Natural Resources/Environment, PO Box 401, Bendigo	4,000.00	''	''
Secure Parking Pty Ltd, 11/180 Russell Street, Melbourne	3,380.95	''	03/12/99
Eastern Energy, 17/452 Flinders Street, Melbourne	580.92	''	10/12/99
Department of Conservation, 310 Commercial Rd, Yarram	250.00	''	17/12/99
Department of Conservation, Ford Street, Wangaratta	500.00	''	''
Department of Conservation, PO Box 269, Orbost	3,000.00	''	''
Department of Conservation, 17 Thompson St, Hamilton	4,000.00	''	''
Department of Conservation, Little Malop Street, Geelong	4,500.00	''	''
Dept of Natural Resources & Environment, PO Box 303, Wodonga	5,500.00	''	''
Department of Conservation, PO Box 151, Seymour	7,800.00	''	''
Dept of Natural Resources & Environment, 71 Hotham Street, Traralgon	11,000.00	''	''
E. P. Morrissey & Co Pty Ltd, 46 Bourke St, Braybrook	11,576.00	''	''
Department of Conservation, PO Box 269, Orbost	3,000.00	''	14/01/00
G. J. Paul, RSD Boundary Bend, Rainbow	1,111.00	''	21/01/00
Department of Conservation, 7 Service Street, Bairnsdale	150.00	''	28/01/00
Tennis Australia, 19/35 Collins Street, Melbourne	203.39	''	18/02/00

Tennis Australia, 19/35 Collins Street, Melbourne	106.83	”	24/03/00
McKean & Park, GPO Box 38A, Melbourne	10,485.50	”	”
Peter John Downes, PO Box 21, St James	225.00	”	31/03/00
Ericsson Australia Pty Ltd, 126–142 Trenerry Crescent, Abbotsford	127.82	”	06/10/98
Logicom Pty Ltd, 83 Flemington Rd, North Melbourne	1,260.82	”	”
Ericsson Australia Pty Ltd, 126–142 Trenerry Crescent, Abbotsford	280.93	”	05/11/98
Long Distance Communications, 179 Mont Albert Road, Canterbury	825.71	”	27/11/98
Logicom Pty Ltd, 83 Flemington Rd, North Melbourne	316.75	”	02/12/98
Ericsson Australia Pty Ltd, 126–142 Trenerry Crescent, Abbotsford	1,506.74	”	29/12/98
Logicom Pty Ltd, 83 Flemington Rd, North Melbourne	864.06	”	”
NEC Australia Pty Ltd, 635 Ferntree Gully Road, Glen Waverley	219.00	”	”
Autobarn-Doncaster, 602– 630 Doncaster Road, Doncaster	847.68	”	19/01/99
Autobarn-Doncaster, 602–630 Doncaster Road, Doncaster	503.00	”	20/01/99
Logicom Pty Ltd, 83 Flemington Rd, North Melbourne	613.00	”	01/02/99
Cygnus Australia Pty Ltd, 125 Campbell Street, Swanhill	1,660.00	”	02/02/99
Long Distance Communications, 179 Mont Albert Road, Canterbury	711.47	”	10/02/99
TFM Australia Pty Ltd, PO Box 615, Box Hill	260.00	”	15/02/99
TFM Australia Pty Ltd, PO Box 615, Box Hill	2,070.14	”	17/02/99
Aust Dried Fruits Assoc Inc., Mildura	174.50	”	03/03/99
INTL Networking Solutions P/L, 224 Queen St, Melbourne	498.00	”	”
VTEL Australia, 60 City Road, Southbank	108.00	”	”
Aust Dried Fruits Assoc Inc., Mildura	168.05	”	31/03/99
Ericsson Australia Pty Ltd, 126–142 Trenerry Crescent, Abbotsford	224.13	”	”
NEC Australia Pty Ltd, 635 Ferntree Gully Road, Glen Waverley	5,327.00	”	29/04/99
Aust Dried Fruits Assoc Inc., Mildura	183.66	”	10/05/99
NEC Australia Pty Ltd, 635 Ferntree Gully Road, Glen Waverley	864.00	”	03/06/99
Executive Phones Pty Ltd, 108 Nepean Highway, Mentone	157.45	”	18/06/99
Mildura Office Equipment, 91 Langtree Ave, Mildura	2,573.44	”	”
Ericsson Australia Pty Ltd, 126–142 Trenerry Crescent, Abbotsford	1,550.61	”	30/06/99
NEC Australia Pty Ltd, 635 Ferntree Gully Road, Glen Waverley	9,760.00	”	”
Telecommunications Resources, 14 Queens Rd, Melbourne	994.00	”	”
Executive Phones Pty Ltd, 108 Nepean Hghway, Mentone	143.76	”	16/07/99
Mildura Office Equipment, 91 Langtree Ave, Mildura	2,420.70	”	”
Long Distance Communications, 179 Mont Albert Road, Canterbury	802.05	”	13/08/99
David Carson Electronics P/L, 19 Pine Avenue, Mildura	390.05	”	”
Ericsson Australia Pty Ltd, 126–142 Trenerry Crescent, Abbotsford	3,145.16	”	30/08/99
Brashes, PO Box 1848Q, Melbourne	150.00	”	08/09/99
Mildura Office Equipment, 91 Langtree Ave, Mildura	211.20	”	17/09/99
TMP National Office, 1/79 Victoria Pde, Collingwood	25,880.00	”	22/09/99

Ericsson Australia Pty Ltd, 126-142 Trenerry Crescent, Abbotsford	325.13	''	29/09/99
Business Computers of Australia, 117 Buckhurst Street, South Melbourne	273.00	''	''
Business Technologies Pty Ltd, Level 1/70 Doncaster Road, Balwyn North	811.00	''	''
NEC Australia Pty Ltd, 635 Ferntree Gully Road, Glen Waverley	22,207.00	''	''
Autobarn-Doncaster, 602-630 Doncaster Rd, Doncaster	600.00	''	08/10/99
Ericsson Australia Pty Ltd, 126-142 Trenerry Crescent, Abbotsford	1,041.43	''	02/11/99
Mobiletronics, 80 Dorcas Street, South Melbourne	180.00	''	05/11/99
Able Phones & Service, 235 Moorabool Street, Geelong	321.00	''	02/12/99
Altair Security & Comm Systems, 61-63 Beverage Drive, Tullamarine	909.38	''	06/01/00
Inchcape Office Products P/L, 740 Springvale Road, Mulgrave	493.87	''	''
Business Computers of Australia, 117 Buckhurst Street, South Melbourne	483.00	''	02/02/00
Autobarn-Frankston 22 Beach Street. Frankston	272.00	''	07/02/00
NEC Australia Pty Ltd, 635 Ferntree Gully Road, Glen Waverley	12,609.32	''	01/03/00
Ericsson Australia Pty Ltd, 126-142 Trenerry Crescent, Abbotsford	456.60	''	02/03/00
Terry Ham Elect Discounts, 729 Sturt St, Ballarat	5,777.20	''	21/03/00
Ngee, Tan	313.50	''	06/01/95
Ng	626.45	''	13/01/95
Simamora, G.	625.97	''	19/01/95
Suzuki, R.	312.79	''	24/01/95
Rodricks	312.55	''	30/01/95
Linyang, Mak	312.55	''	''
Pelmen	312.51	''	31/01/95
Ng, Desmond	312.51	''	''
Tam, Alan	624.94	''	01/02/95
Sawakok, K.	624.94	''	''
Liu Ka Wo, Anthony	312.39	''	03/02/95
Hodges, Brett	374.72	''	06/02/95
Kunne, A.	187.34	''	07/02/95
Hansen	312.23	''	''
Lim, Chee	312.19	''	08/02/95
Wong, Han Yu	312.11	''	10/02/95
Lim, Sharon	312.11	''	''
Tan, Hui Koon	312.11	''	''
Tjipto	374.53	''	''
Chama	623.91	''	14/02/95
Yucel	311.87	''	16/02/95
Tambayong, Rudy Wahyudy	623.65	''	17/02/95
Roberts, Mira	311.70	''	20/02/95
Duam, H.	311.66	''	21/02/95
Dufus, Camelia	498.44	''	24/02/95
Ange, Julia	623.06	''	''
Ywan	311.36	''	28/02/95
Hong, Lin Hwa	311.36	''	''

Lee, Tonya Michelle	373.63	''	''
Wong, Y.	311.27	''	02/03/95
Westhuizen, M. P. Van Der	311.27	''	''
De Androado	311.27	''	''
Shindo, S. T.	311.27	''	''
O'Donnell, D.	311.23	''	03/03/95
Wroblewski, K.	373.48	''	06/03/95
Coetzer, B.	311.06	''	07/03/95
Robinson, F. J.	310.98	''	09/03/95
Yakub, Mohammad	310.98	''	''
Nuku, 871 Doncaster Road, Melbourne	310.98	''	''
McLeod	310.93	''	10/03/95
Read, Gavin	310.93	''	''
Kamthasamy, R.	310.93	''	''
Murphy, D.	310.76	''	14/03/95
Schreiber	310.76	''	''
Yeoh, E.	310.76	''	''
Wincer, P.	310.72	''	15/03/95
Smith, D. M.	310.68	''	16/03/95
Cook, A. M.	310.68	''	''
Quest, B.	372.81	''	''
Tralec, D.	310.64	''	17/03/95
Shen, Douglas	621.27	''	''
Yu, S.	310.51	''	20/03/95
Nguyen, Hong	310.51	''	''
Wahyu, Tri	621.02	''	''
Higgins, C.	310.47	''	21/03/95
Hsieh	310.42	''	22/03/95
Neveux, J. M.	310.38	''	23/03/95
Godfrey, R. J.	310.38	''	''
Chui, M.	310.34	''	24/03/95
Oh, S. J.	310.34	''	''
Anderson, J.	310.34	''	''
Dahiya, D.	310.21	''	27/03/95
Masunaga, Y.	310.21	''	''
Moa Int Aust Ltd	310.21	''	''
Rigby, Leila	186.08	''	29/03/95
Nguyen, A.	310.13	''	''
Day	372.05	''	31/03/95
Rogers	309.87	''	04/04/95
Peerson	371.85	''	''
Cheng	309.74	''	07/04/95
Doctor T. M. Craig, 7 St Agnes Crt, Avondale Heights	309.62	''	10/04/95
Gates, M.	309.62	''	''
Yu, F.	309.62	''	''
Hills, J. H.	123.83	''	11/04/95
Puspito	309.57	''	''
CCP Management	371.39	''	13/04/95
Stephens, W.	309.28	''	18/04/95
Stammers	309.28	''	''
Dawes	309.23	''	19/04/95
Peh	309.15	''	21/04/95
Nguyen	309.15	''	''

Ni	618.30	''	''
Glory	308.94	''	26/04/95
Fujii	617.79	''	27/04/95
Barton	308.85	''	28/04/95
Brown	308.73	''	01/05/95
Windridge	308.68	''	02/05/95
Fraser	308.68	''	''
Garrod	308.64	''	03/05/95
Hui	308.56	''	05/05/95
Glass	308.56	''	''
Mangione	308.43	''	08/05/95
Rose	308.39	''	09/05/95
Dan	308.34	''	10/05/95
Yu	616.69	''	''
Troughton	308.26	''	12/05/95
Oagodziewicz	308.05	''	17/05/95
Plunkett, P.	369.66	''	''
Haritou, F.	307.85	''	22/05/95
McGroary	307.82	''	23/05/95
Cotterell	307.74	''	25/05/95
Bailey	307.70	''	26/05/95
Stephens	307.58	''	29/05/95
Brooks, S.	307.42	''	02/06/95
Uhd	307.42	''	''
Morris	368.58	''	09/06/95
Chapment	368.25	''	16/06/95
Baola	184.06	''	19/06/95
Neve	613.52	''	''
Barker	306.72	''	20/06/95
Njavac	367.74	''	27/06/95
Graham	306.37	''	29/06/95
Hishamuddin	306.21	''	03/07/95
Logiudice	306.21	''	''
Fernandez	305.94	''	10/07/95
Parkash	305.94	''	''
Juan	305.94	''	''
Sadily	611.88	''	''
Dang	305.90	''	11/07/95
Bloom	305.90	''	''
Robert	305.86	''	12/07/95
Iskandar	611.73	''	''
Foo	309.45	''	14/07/95
Chun	309.45	''	''
Namba	618.89	''	''
Panozzo	305.67	''	17/07/95
Bailey	305.67	''	''
Reilly	305.63	''	18/07/95
Kuboto	305.39	''	24/07/95
Pitakpoolsin	305.36	''	25/07/95
Hadi	610.71	''	''
Davie	244.25	''	26/07/95
Lim	610.63	''	''
Patterson	305.12	''	31/07/95

Hadi	305.12	”	”
Mifsud	305.08	”	01/08/95
Sam	305.00	”	03/08/95
Sparman	304.97	”	04/08/95
Golding	304.97	”	”
Hguyen	304.85	”	07/08/95
Yuen	609.62	”	08/08/95
Boeti	365.68	”	10/08/95
Owen	304.69	”	11/08/95
Mackley	304.57	”	14/08/95
Choy, Mr Samuel	304.50	”	16/08/95
Loveridge	304.50	”	”
Gvozvic, Mr	304.42	”	18/08/95
Mok, Mr	304.42	”	”
Tang, Mr S. L.	608.84	”	”
Mhall, Mr Gary	304.30	”	21/08/95
Stuart, Heath	304.26	”	22/08/95
Martin	304.18	”	24/08/95
Furness	365.02	”	”
Perera	304.15	”	25/08/95
Campbell, C.	304.15	”	”
Lee, Mr	304.15	”	”
Lee, Wei	304.03	”	28/08/95
Thissens, Miss K. D.	303.99	”	29/08/95
Newman, Jason	303.99	”	”
Farzam, Issa	151.98	”	30/08/95
Claasson, Ms	303.95	”	”
Hugg Business & Travel	303.95	”	”
Low, Mr K. L.	607.82	”	31/08/95
Bolton	303.87	”	01/09/95
Bennett, Miss	303.65	”	07/09/95
Barrand, Ms S.	303.65	”	”
Leighton, Mr G.	303.61	”	08/09/95
Tan, Ms Wan	303.61	”	”
Pearce, Mrs V. M.	303.50	”	11/09/95
Dean, Mr S. A.	606.99	”	”
Gaaman Ly	303.42	”	13/09/95
Chen	606.76	”	14/09/95
Watkinson	151.67	”	15/09/95
Tan, Mr D.	606.16	”	22/09/95
King, Ms L.	302.82	”	29/09/95
Collins, Mr	302.82	”	”
Hayward	302.82	”	”
Stevens, J.	302.82	”	”
M. C. Dahlstrom, P O Box 348, Ballarat	310.57	”	02/10/95
Mok, Mr	605.41	”	”
Simms B.	302.63	”	04/10/95
Meszaros	151.30	”	05/10/95
Lam, W. L.	302.55	”	06/10/95
Murphy, Ms S J, 6 Tuson St, Horsham	302.55	”	”
Ballard	302.55	”	”
Bond, M. J.	605.11	”	”
Wyngaard, D.	302.44	”	09/10/95

Grimes, M.	302.33	''	12/10/95
Doreen, Michelle	302.29	''	13/10/95
Chu, W. K.	604.35	''	16/10/95
Fedley	302.14	''	17/10/95
Scott	302.14	''	''
Zeng, W. Y.	604.28	''	''
Olser	302.10	''	18/10/95
Belo, Di	302.10	''	''
Hiroshi	302.10	''	''
Okada	604.20	''	''
Smith, B. H.	302.06	''	19/10/95
Britton	241.62	''	20/10/95
Pereira	302.03	''	''
Toogood, A. B.	302.03	''	''
Couchman	301.91	''	23/10/95
Montgomery	301.88	''	24/10/95
Chan	301.88	''	''
Luk	301.84	''	25/10/95
Chow	603.68	''	''
Durrance	301.65	''	30/10/95
Fernandez	301.61	''	31/10/95
Pinnell	301.61	''	''
Spencer	301.61	''	''
Smith Ramon	301.57	''	01/11/95
Petrie	603.15	''	''
Hague	301.31	''	08/11/95
Cohen	301.31	''	''
Cheung	301.31	''	''
Woods, Mr Ron	301.08	''	14/11/95
Nielson, Mikal	301.05	''	15/11/95
Kisiaah, W. R.	304.32	''	16/11/95
Mimura	601.64	''	21/11/95
Caldwell, Miss	300.78	''	22/11/95
Conabere, Mr	300.78	''	''
Leong	601.42	''	24/11/95
Kim, Mr Ho Jin	601.19	''	27/11/95
Flood	300.56	''	28/11/95
Printing & Design	300.56	''	''
Catanese, Mr J.	300.56	''	''
Wangsawijaya, Miss	601.11	''	''
Crichton	327.48	''	29/11/95
Chi, Mr Lian Qing	601.04	''	''
Yeung, Mr Patrick	300.44	''	01/12/95
O'Brien, S.	300.44	''	''
McLean, Mrs M,	300.33	''	04/12/95
Judd	300.29	''	05/12/95
Clark	300.29	''	''
Bilinski, Natalie	300.29	''	''
Phan, Mr Thuan Loc	600.59	''	''
Stolke, Andy	300.26	''	06/12/95
Alfredson, Natalie	300.26	''	''
Zurvas, Mr D.	300.22	''	07/12/95
Davies, Mr J.	300.22	''	''

Murphy, Mrs K. L.	300.22	”	”
Reidy, Ms J.	300.18	”	08/12/95
Suen, Miss	300.18	”	”
Shoi, Mrs S.	600.36	”	”
Bowen, Miss N.	300.07	”	11/12/95
Corner, Mr	300.03	”	12/12/95
Wong, Miss M.	299.99	”	13/12/95
Lupton, Mr J.	299.92	”	15/12/95
Koumarianos, E.	299.80	”	18/12/95
Wu, Mr Hong	299.80	”	”
Clark, Mr Steven	599.61	”	”
Lane, Faye Joyce	299.77	”	19/12/95
Dixon, Saul	299.73	”	20/12/95
Grigoriadis, Joy	299.69	”	21/12/95
Shingler	299.65	”	22/12/95
Wood, Greg	299.65	”	”
Modica, P.	299.46	”	27/12/95
Harris, Rodney	299.46	”	”
Robinson, Miss J.	299.43	”	28/12/95
Foster, Michael	299.39	”	29/12/95
Ford, Mr	299.20	”	03/01/96
Griffin	299.16	”	04/01/96
Hoy, Anthony	299.13	”	05/01/96
Birchwood	299.01	”	08/01/96
Bond, Crystal	299.01	”	”
Lindstrom, Ms L.	598.02	”	”
Huang, Mr	298.94	”	10/01/96
Doe	298.94	”	”
Heke, Mr	597.80	”	11/01/96
Ju, Ms B.	597.72	”	12/01/96
Powell	298.60	”	19/01/96
Fletcher, Mr G.	298.48	”	22/01/96
Gavin	298.22	”	29/01/96
Knights	298.07	”	02/02/96
Chandra, I.	596.14	”	”
Al Atelyeh, Mr Mustafa	297.96	”	05/02/96
Wong, Mrs	595.92	”	”
Burford, Ms C.	297.81	”	09/02/96
Francisca, Ms	595.61	”	”
De Vries, Miss Lenny	297.69	”	12/02/96
Lee, Mr	297.58	”	15/02/96
Suvitayasatian, Mr	595.16	”	”
Chung, Mr Shan Lam	595.16	”	”
Lucas, Mr B.	297.43	”	19/02/96
Hyung, Mr Jang	594.86	”	”
Ng, Ms D.	594.86	”	”
Woraprukdeekun, Miss P.	594.86	”	”
Tahir	594.86	”	”
Doherty, R.	297.39	”	20/02/96
Labro, Vrakas	297.35	”	21/02/96
Vivey, Mr Patrick	297.32	”	22/02/96
Li, Mr Doug	297.32	”	”
Atkinson, S. J.	297.32	”	”

Yates ,Mr Kevin	594.63	”	”
Lee, Don	297.28	”	23/02/96
Su, Miss Wendy	594.56	”	”
Go, Mr Wayudi	594.56	”	”
Setiawati	594.33	”	26/02/96
Ruankaew	594.33	”	”
Cheng, Miss	594.26	”	27/02/96
Hinawan, Miss Yenny	594.26	”	”
Tuon Chin	297.09	”	28/02/96
Ma, Mr Yin Man	594.18	”	”
Lewis, P	295.87	”	29/02/96
Talbot, Mr M.	297.05	”	”
Schuller, Mrs	594.11	”	”
Jackson, Mr Mark	297.02	”	01/03/96
Raymer, Robert	297.02	”	”
Kwang, Yak Ho	594.03	”	”
Nikolitsis, Mr Harry	296.90	”	04/03/96
Nguyen, Son	296.83	”	06/03/96
Tomualana, Mr	593.65	”	”
Sullivan, Peter	296.79	”	07/03/96
Hollins, P.	296.79	”	”
Richards	296.75	”	08/03/96
May, Mr I.	296.75	”	”
Tsang, Ms Nonica	593.50	”	”
Lesser, Mr	296.60	”	12/03/96
Sinulingga, Mr Ariesta	593.20	”	”
Chow, Yeu Patrick	593.20	”	”
Angwin, Mrs	304.41	”	25/03/96
Palackic, S.	310.16	”	11/04/96
Mak, L.	627.77	”	”
Ho, Mr C.	590.64	”	15/04/96
Wong, Wendy	295.21	”	18/04/96
Coleman	305.23	”	”
Smith, A.	305.36	”	”
Widjaja, Anthony	625.45	”	”
Shiner	294.98	”	24/04/96
Goldsmith	293.10	”	13/06/96
Lander, Mr	291.82	”	17/07/96
Dewit	304.84	”	23/07/96
Amore, Antonio	301.97	”	26/07/16
Teodoro, Mr	582.96	”	”
Lim	310.27	”	31/07/96
Warner	291.12	”	05/08/96
Chan, Mr I.	290.81	”	14/08/96
Williams, S. A.	289.44	”	23/09/96
Duong, Ms H.	288.68	”	15/10/96
Jusuf, Mr	576.82	”	23/10/96
Nguyen	303.90	”	21/11/96
Helman, B. P.	137.81	”	29/11/96
Phoung, Miss L. Y.	304.90	”	”
Harold, Jermiah	573.65	”	12/12/96
Book Works Printing	285.51	”	29/01/97
Yu, Miss C. A., Unit 109, 339 Swanston Street, Melbourne	626.28	”	08/07/97

Goh, Chee Whua	636.32	''	18/08/97
Gardner Smith Pty Ltd, PO Box 247, Wagga Wagga, NSW	100.42	''	20/12/97
Verisign Inc., 2593 Coast Ave, Mountain View, California	698.00	''	''
R.M.I.T, GPO Box 2476V, Melbourne	1,880.00	''	28/05/97
Mr Gregory Garland, 5 Hyland Crescent, Yarram	208.05	''	16/10/98
Liquor Stop, 1042 Heidelberg Road, Ivanhoe	251.55	''	23/10/98
Mr D.Owens, 1040 Riddell Rd, Sunbury	103.74	''	20/11/98
Mr F.Strangio, Block 99C, Woomera Ave, Red Cliffs	190.30	''	''
D. Dean, 29 Lansdowne Rd, East St Kilda	266.30	''	11/12/98
Mr Peter Moody, 60 Warrawee Rd, Mt Evelyn	180.00	''	18/12/98
Ivan Eng, 26 Lansbury Crescent, Highton	164.47	''	01/01/99
Mrs S. McKenna, Mals 12, Unit 37161, Fpo Ap 96603/7161	201.62	''	15/01/99
Mr Y. Yakob, 90/145 Canterbury Road, Toorak	123.25	''	05/02/99
National Mutual Financial, 3rd Floor, 447 Collins Street, Melbourne	211.40	''	''
Pleasure Boat Cruises P/L, 11/28 Gloucester Ave, Berwick	1,395.00	''	12/02/99
V. Keleher, 18/15 Rockley Rd, Sth Yarra	1,251.75	''	19/02/99
Mallinckrodt Medical P/L, PO Box 944, Nottinghill	277.53	''	26/02/99
Rocla Quarry, PO Box 67, Springvale	700.80	''	''
Allersearch, Unit 3, Rooks Rd, Vermont	894.77	''	''
Thoneman Robertsn Thompson P/L, 4/395 Collins Street, Melbourne	1,321.49	''	''
Kool Kiwi Pty Ltd, 14 George Street, Oakleigh	157.50	''	12/03/99
Mr S. Herni, 7 Ketwick Crt, Sydenham	282.75	''	09/04/99
Amcor Fibre Packaging, 971 Bourke Rd, Camberwell	6,801.04	''	''
Mr D. Harrison, 31 Wood Street, Drouin	269.55	''	16/04/99
Mr S. J. McNamana, 8/2 May Grove, Sth Yarra	239.35	''	21/05/99
Mr C. Mahony, PO Box 1158, Geelong	100.00	''	04/06/99
Mr I Ashley, 1/20 Kokaribb Rd, Carnegie	132.96	''	18/06/99
VTEL Australia Pty Ltd, Level 3, IBM Tower, Southbank, Melbourne	173.55	''	''
Mr L. Longo, 99 Wilson Blvd, Reservoir	202.45	''	25/06/99
Ferntree Computer Corp, 310 Ferntree Gully Rd, Clayton	889.97	''	''
Blue Cross Commuinity Care Services, Stanleigh Lodge Racf Po Box 214, Glen Iris	200.15	''	13/11/98
Pashen, Rob Mr, 54 Kalimna Drive, Mornington	153.25	''	13/12/98
Goldsmith Properties Pty Ltd, 3470 Warburton Hwy, Warburton	232.70	''	28/01/98
Creative FX Pty Ltd, PO Box 49, Brunswick	208.28	''	19/01/99
Services Corporation International, PO Box 2006, Albert Park	143.90	''	25/02/99
Clayton R. Martin, 4/12 Techno Park Rd, Williamstown	100.81	''	27/11/98
Michael Biviano, 198 High St, Ashburton	335.53	''	11/03/99
M. C. Gilbert. Suite 3, Level 1, 40 Young St, Frankston	190.35	''	07/01/99
Fernwood Fitness Centre P/L, Level 1, 602 Whitehorse Rd, Mitcham	418.00	''	19/08/98
Sfetcopoulos Enterprises Pty Ltd, PO Box 45, Shepparton East	120.68	''	26/08/97
Ford Trans, PO Box 193, Brighton	105.00	''	25/06/99
A. W. Porter, 460 Toomuc Valley Rd, Pakenham Upper	162.85	''	19/01/99
Propaganda Clothes Australia Pty Ltd, Shop 175, Melbourne Central 300 Collins St, Melbourne	105.46	''	02/06/99
Victorian Road Transport Association, PO Box 5, South Melbourne	135.10	''	09/09/96

Ms Janine Newman, Accounts Dept - Level 44, 120 Collins St, Melbourne	137.88	''	02/01/98
Ilse Forysth, 794 Hampton Street, Brighton	101.75	''	05/11/98
J. B. Foster, PO Box 286, Mt Eliza	108.90	''	14/04/99
Fletcher Jones & Staff Pty Ltd, PO Box 98, Avondale Heights	1,883.56	''	12/03/98
Imer Fidel, 4 Tirhatuan Dr, Rowville	134.85	''	10/03/99
Klass Sybranda, C/o Dickens Real Estate, 7 Hollands Street, Mt Beauty	378.00	''	17/11/97
Gerald Lubowa, Flat 3/19 Emily St, Carnegie	150.60	''	22/07/98
Linda Downs, 181 Harkaway Rd, Harkaway	108.35	''	17/06/99
Ian Doncaster, 115 Spavin Drive, Sunbury	162.00	''	06/11/97
A. M. Lunstrom, 15 David Street, Knoxfield	135.00	''	05/06/99
Daryl Read, 18 Christie Street, Knoxfield	114.20	''	19/10/98
Terrence Richard Jackson, C/ S. Rose, Ncc. 4/333 Queen Street, Melbourne	202.25	''	13/08/98
Vietnam Chamber of Commerce, Level 2, 509 St Kilda Road, Melbourne	281.55	''	27/08/96
Belinda Joy Patterson, Flat 37, 11-13 Cooma St, Preston	320.00	''	30/03/99
P. L. Nankivell, Kelly & Missing, 37 South Caroline Street, South Yarra	343.48	''	02/02/99
Thi Sach Nguyen, 674 Ferntree Gully Rd, Mulgrave	104.25	''	07/10/98
PR McDonald & Sons Pty Ltd, PO Box 130, Richmond	250.00	''	21/10/97
Procal Australia Pty Ltd, 4 Vinen Rd, Scoresby	116.20	''	15/09/97
Anna Hordern, Unit 3 11 Wimmera Pl, St Kilda	114.40	''	28/05/98
Owen Cabinets Pty Ltd, 3 Brunson St, Bayswater	147.10	''	02/02/99
Corporation Pty Ltd, Amerinaus Account Consolidation, 200 Toorak Road, South Yarra	383.10	''	27/06/96
Infomark Corporation Pty Ltd, 616 Warragul Road, Malvern East	100.57	''	15/02/99
Peter Betros, 148 Hotham Street, East Melbourne	287.40	''	14/12/98
Avenel Swimming Pool, Queen Street, Avenel	177.15	''	05/06/97
Hi-Tech Security, 3 Josephine Cl, Ferntree Gully	923.40	''	20/10/97
McQuinn, 22 Haywood Street, Morwell	110.00	''	21/04/98
Mareeta Anne Bennett, 60 Main Street, Romsey	176.85	''	23/09/98
Stanbury Scarfelord Pty Ltd, Factory 2, 5 Samantha Crt, Scoresby	140.00	''	14/12/98
Jet Secretarial Service & Exec., Level 4, 450 St Kilda Road, Melbourne	114.60	''	06/08/98
T. A. Body Corporate Plan, Raywhite Project Marketing P/L, Level 3, 410 Lonsdale Street, Melbourne	312.00	''	05/12/97
La Bella Vittoria Restaurant, 343 Smith St, Fitzroy	123.70	''	25/05/99
Charles Burder, Ta Valley Steel Shed, Lot 2 Mansfield Road, Whitfield	126.01	''	10/12/98
Gippsland & Mountain District, Ta In De Groove Music, PO Box 156, Pakenham	137.44	''	21/01/99
Sean James Fitzpatrick, 65 License Rd, Diggers Rest	105.95	''	11/03/99
Silvie Muntoro, Unit 6, 14 Arnold St, South Yarra	145.00	''	26/05/97
Indigo Way, Stanley Street, Wodonga	151.75	''	21/05/99
Anthony Nicholas Pickworth, C/o Post Office, Ardmona	103.45	''	14/12/98
Karen Maree Milne, 14 Selwyn Street, Canterbury	406.65	''	21/09/98
Navix Line Ltd, Mitsui Bulk Shipping P/L, GPO Box 4533 SS, Melbourne	179.05	''	26/04/99

Holland Technical Services Pty, 7 Camphor Cls Listerfield, Lysterfield	101.63	''	22/01/99
Greg Nikitakis, 110 Seebeck Road, Rowville	160.00	''	26/03/99
Debco Pty Ltd, 12 McCKirdys Rd, Tyabb	239.40	''	19/02/96
Mr Malcolm Barry James Barbutt, T/a Prompt Marketing, Berri SA, PO Box 572, Mildura Private Boxes	183.76	''	03/11/98
Michelle Janet Allen, 88 Buckingham St, Richmond	585.05	''	20/01/99
Martin Zeljko Barun, Unit 2, 67 Azure Drv, Wodonga	100.00	''	16/12/97
Leo P. Cahill, Byrne, House RMB 9180, Docker	108.60	''	18/01/99
Arzu Akovali, Rear 19 Winn Gr, Fawkner	309.75	''	07/08/97
Francoise Christine McGaw, Unit 1, 3 Starcross Ave, Croydon	100.35	''	06/07/98
Pauline Joy Walker, 37 Belmore Street, Yarrowonga	116.30	''	30/06/99
Arvonne Lilliance Segal, Suite 2, 19 Queens Rd, Melbourne	101.48	''	05/08/98
Michael Evans, 22 Mena Avenue, Cheltenham	124.70	''	13/04/99
Isabella Gray Lyall, 11 Prosper Crt, Wodonga	190.90	''	04/11/98
Aiesha Cipriani, 62 Caroline Street, South Yarra	131.00	''	27/04/99
John Hannah Mawal, 6 Down Street, Reservoir	135.55	''	17/12/97
Samual Selim, Unit 3 52 Evelyn Road, Ringwood	283.70	''	11/05/99
National Airline Commission, PO Box 1464, Collingwood	106.75	''	27/05/97
Warren A. Hulstaert, Unit 2 231 Canterbury Rd, Bayswater	100.00	''	11/12/98
Peggy Converse, 20 Burgess Street, Richmond	200.71	''	09/12/97
Adam Neil McMillan, 26 Saxon Ave, Wantirna Rowville Brake & Clutch R., 17 Cinerea Avenue, Ferntree Gully	121.10	''	17/06/97
Interlink Services, Lvl9 420 St Kilda Road, Melbourne	202.10	''	01/02/96
Jane Bensch, 30 Grayson Drive, Scoresby	691.55	''	26/03/98
Daniel Stone, 55 Felix Crs, Ringwood	150.00	''	07/10/97
Daniel Stone, 55 Felix Crs, Ringwood	100.20	''	29/05/98
Deirdre Patrica McCullough, 98 Dorset Rd, Croydon	219.87	''	09/09/98
Piphat Bijendrayodhin, Flat 1:23 Washington St, Toorak	468.95	''	15/04/97
Audio Productions Pty Ltd, 4 Lumeah Avenue, Olinda	123.40	''	19/05/98
Thomas Siep, C/- Shell Australia, 1 Spring St, Melbourne	108.64	''	21/12/98
Chris Reid, 52 Atheldene Drv, Glen Waverley	220.00	''	11/03/99
Cheryl Birrell, 579 Maroondah Hwy, Ringwood	198.25	''	13/06/97
Nick Kalliakoudis, Flat 4, 458 St Kilda Rd, Melbourne	101.15	''	11/10/96
Harold Access Pty Ltd, Level 2, 171 Collins St, Melbourne	178.90	''	04/02/99
Clive Terence Adams, Unit 2, 110 Caroline St, South Yarra Mandarin Offset Pty Ltd, Reed Books Australia, 35 Cotharn Road, Kew	187.45	''	02/10/98
Christie-Anne Anderson, 2 Allister Cl, Knoxfield	659.44	''	29/10/97
Tamara Hudson, Flat 2, 32 Summerhill Rd, Glen Iris	100.00	''	09/09/96
M. D. Kellas, 19 Kemps Road, Ringwood East	136.90	''	31/12/98
M. D. Kellas, 19 Kemps Road, Ringwood East	100.00	''	20/06/97
Kveta Lucapo, Unit 7, 891 Punt Road, South Yarra	214.15	''	14/04/98
Intergraph Corporation Pty Ltd, 311 Glenferrie Rd, Malvern	450.17	''	02/07/98
Helen Drennen, 5 Fawkner Avenue, Blairgowrie	177.65	''	29/04/97
Cable Logging Pty Ltd, PO Box 147, Neerim South	185.35	''	28/04/99
Nigel Coxhill, 16 Telfer Crt, Rowville	102.65	''	05/05/99
Brown Gouge Ltd, 1st Floor, 109 Canterbury Rd, Heathmont	328.35	''	27/11/95
Denise Barnett, 4 Castle Street, Ferntree Gully	210.05	''	15/01/99
Tessa Golding, 6 Ealing Crs, Springvale	109.05	''	02/11/98
Clare Elizabeth Taylor, 11 Reeve Crt, Cheltenham	140.10	''	15/09/98
Marlene Joy Graham, Ardmona Rd, Merrigum	106.10	''	11/09/97

John B. Woodruff, 609 Church Street, Richmond	129.00	''	13/05/99
Training Centre Inc. Traralgon, PO Box 886, Bairnsdale	362.60	''	29/06/99
J. C. Roberts, 115 O'Connor Rd, Knoxfield	139.34	''	15/12/98
Peter G. Bithos, C- Kay Burton P/L, 226 Toorak Road, South Yarra	246.25	''	15/10/98
Vaba Co-Op Cas Pty Ltd, Att: Grant Wallace, PO Box 370, South Melbourne	120.73	''	02/06/98
Daniel Croke, 278 Reynard Street, Coburg	116.95	''	23/10/97
V. F. Tonin, Ta Mama Vittoria Restaurant, 353 Smith Street, Collingwood	183.75	''	10/03/98
Grant Lawrence Connoley, 7 Wellesley St, Mont Albert	101.95	''	26/05/99
Keellie Jo-Ann Sutherland, 8/50 Barkly St, Carlton	106.15	''	08/04/98
Boldell Pty Ltd, 70 Sydney Road, Brunswick	226.55	''	26/02/99
Brashs Pty Ltd, Locked Bag 5635, Melbourne	518.06	''	10/06/97
PJ Ceramics Pty Ltd, Shop 2 9 Keilor Rd, North Essendon	316.45	''	21/05/99
Ureform Pty Ltd, 5 Rutherford Road, Seaford	136.30	''	12/01/99
Dymocks Melbourne P-L, Cnr Bourke and Swanston Street, Melbourne	103.50	''	07/12/97
Cathryn Forte, 505 Ballarat Road, Batesford	100.00	''	15/11/96
Hoogies Hardware Pty Ltd, 98 Uplands Rd, Yarra Glen	107.15	''	17/05/99
Unisoft Pty Ltd, 173 Burke Road, Glen Iris	152.88	''	08/03/99
Tryce Electrical Engineering, Unit 1, 1 Mcdowell Street, Greensborough	281.83	''	25/02/99
Thompson Bill Village Vintage, 148 Maroondah Hwy, Ringwood	107.35	''	11/12/98
Cummings Agencies Pty Ltd, 18 Taylors Lane, Rowville	1,419.24	''	16/10/97
Steinmark Pty Ltd, Admin Appt - Pre Debt, P.O. Box 307, Deepdene Delivery Centre	101.91	''	22/01/98
Steve Curnow, Suite 41, 431 St Kilda Rd, Melbourne	263.45	''	20/12/98
Errol Street Hardware Pty Ltd, 45 Errol St, North Melbourne	122.55	''	22/01/99
Nissan Motor Co Aust P/L, 260-284 Frankston Road, Dandenong	241.45	''	08/10/98
Caledonia Lumber Co Pty Ltd, P O Box 2096, North Brighton	228.05	''	04/01/99
A. R. Simpson Holdings Pty Ltd The Manager, Att: Sophie, Floor 1, 8 Trenerry Crs, Abbotsford	256.05	''	20/05/99
Franz Jauk, 22 Whitmuir Road, Bentleigh	130.75	''	01/06/99
Mark John Freakley, C/o Post Office, Kyabram	143.50	''	09/10/98
Julianne Margaret Ross Soden, RMB 2035, Strathmerton	300.00	''	22/04/99
Peter Philpot, Shop 2, 97 Commercial St, Merbein	235.35	''	08/12/97
Peter Farren Fazza's Electrics, 16 Morrish Rd, Shepparton	135.68	''	25/03/99
Kellie Narelle Van De Ven, Unit 3, 2 Bona Vista Avenue, Surrey Hills	111.85	''	14/05/99
Barry Jarvis, 90 Birkett Street, Euroa	154.50	''	23/01/98
J. L. Millard, 14 Branjee Road, Euroa	100.00	''	14/10/97
Kathryn Louise Templeton, 10 John St, Balwyn	219.40	''	20/10/98
F. Sutton, Dy Services 113 Grieve Parade, Altona	125.00	''	14/04/99
F. Johnston, 6 Yandalla Street, Balwyn	120.45	''	08/04/98
Ink Jet Express Pty Ltd, 370 Centre Road, Bentleigh	108.85	''	09/11/98
Helen Sketcher, 27 Dower Street, Burwood	100.00	''	19/06/99
Adam Pottini, C&C Servi, 23 Bell Avenue, Altona	128.35	''	13/04/99
Llyndell Gai Johnes, 63 Roseberry St, Ascot Vale	169.50	''	07/08/97
Programmed Light Maintenance Ltd, 1 Leete St, Kyneton	254.45	''	04/12/98

Michael Atran, 483 Glenhuntly Rd, Elsternwick	125.15	''	01/07/97
Patricia Valori, 64 Middlesex Rd, Surrey Hills	130.80	''	13/06/99
Ian McLellan, 2 Exley Road, Moorabbin	105.10	''	03/05/99
Sherie J. Mills, 30 Rupert Street, Broadford	200.00	''	15/12/97
Agnes Joyce Hancock, C/o Angle & Partner, PO Box 464, Bairnsdale	103.20	''	04/11/98
Helen Marie Locke, State Trustees, GPO Box 1461N, Melbourne	179.70	''	11/02/99
Guy Campbell, C/o Moby Dick Productions, PO Box 4585 FS, Melbourne	485.00	''	05/11/97
Colin Cherry, 16 Viscount Drive, Doncaster	150.00	''	15/06/99
Elizabeth Kidman, C/o M. Spry 52 Macarthur St, Malvern	207.55	''	23/12/98
Mrs R. C. Mott, PO Box 385, Swan Hill	143.45	''	09/10/98
Rosemary Payne, Ta Kilmore Tourism, Shire of Mitchell, 113 High Street, Broadford	100.85	''	08/10/97
Mr M H Auld, PO Box 20, Stanhope	1,375.35	''	01/12/98
E. F. Warford, PO Box 210, Swifts Creek	100.00	''	03/09/98
Michelle Julie North, PO Box 243, Paynesville	104.75	''	05/10/98
D. & M. Ryan Pty Ltd, 6 Bella Court, Mulgrave	111.62	''	05/02/99
Philomena Ryan, 52 Wedding Drive, Wallan Wallan	157.30	''	27/05/98
Lloyd Robert Borrett, PO Box 195, Brunswick East	100.00	''	16/04/98
Helen Grinter, PO Box 406, Bairnsdale	354.50	''	23/02/99
Merle Williams, 17 Service Street Porepunkah	100.05	''	18/02/99
Mason & Brown, 67 Ellerina Rd West, Mt Martha	106.85	''	30/03/98
Ing Road Cofee Lounge Apagun P/L, PO Box 2032, Camberwell	107.15	''	20/10/98
Melbourne Slate Centre P/L, 4 Williamstown Rd, Footscray	111.95	''	23/05/98
Johnathan Philip McLean, 107 Hight St, Broadford	161.50	''	08/12/98
Michael John Harrington, 33 Phillips St, Shepparton	100.00	''	19/08/98
Charmaine Laveglia, 33 Hakea St, Tecoma	150.25	''	14/05/97
Jarrod Bruce Fraser, 16 Dawson St, Bairnsdale	115.85	''	09/12/98
B F O'Connor, RMB 2500, Euroa	111.20	''	03/12/98
Moll Hawk Investments Pty Ltd, 42 Bank St, Port Fairy	150.00	''	14/04/98
Roslyn Barbara Bruce Hancocks, Bridge Rd, Kotupna	114.00	''	26/02/97
Silky Blinds Pty Ltd, In Liquidation (Pre-Debt), GPO Box 4736UU, Melbourne	168.09	''	16/06/99
Jane Newbound, 430 Long Gully Rd, Pantom Hill	250.60	''	12/05/98
W. Robinson, 1015 Somerton Road, Greenvale	195.20	''	30/03/99
Bizplay Pty Ltd, 68 Park Street, Moonee Ponds	237.90	''	09/10/98
McFarlane Marketing Pl, 401 Canterbury Rd, Surrey Hills	116.45	''	02/12/98
James Anthony Long, Unit 8D, 312 Dryburgh Street, North Melbourne	119.35	''	29/01/99
Geoffrey Robert Carlaw, 2 Stanhope St, Footscray West	250.00	''	10/09/98
Myrna Webb, 2 Smart Crt, Delahey	160.00	''	08/04/99
Lolita Leusenkamp, 9 Issac Crt, Cranbourne	100.00	''	23/08/96
Shirley Nissen, 18 Glenmer Street, Moorabbin	198.00	''	22/05/97
Sharon Marie Lewis, 11 Bowen St, St Arnaud	429.85	''	21/06/99
Colin Peter Hutchinson, Flat -105-235 Nelson Pl, Williamstown	110.00	''	14/05/97
John Lee, 18 Saunders Street, Kyabram	108.20	''	01/02/99
BTR (Psa Region), GPO Box 779H, Melbourne	256.90	''	25/07/98
Cobal Holdings Pty Ltd, 380 Lonsdale Street, Melbourne	143.71	''	05/03/96
Sun Dried Fruit Packing Co, PO Box 174. Altona	151.55	''	05/05/99

Billrich Special Services Pty, 55 Qrgyle St, Traralgon	105.05	''	19/08/97
Glass, Eileen, Level 12, 10 Queens Rd, T/a Melbourne Telephonist, Melbourne	115.59	''	31/03/99
Mr Adrean Drake, 3 Bond St, Braeside	150.00	''	17/07/95
Steven Charles Abeckett, Apartment Gd, 18 Albert Road, South Melbourne	127.35	''	21/01/99
Ceduna Investments Pty Ltd, T/a Tile Mart Wodonga, 153 Melbourne Road, Wodonga	129.25	''	01/12/98
Doveton Meat Supply Pty Ltd, 84 Toomuc Valley Rd, Pakenham	274.75	''	23/07/97
Jacqui Seabrook, RMB 1580, Mitiamo	157.30	''	15/06/99
E Machinery Antonette Khawaja, E Machinery, 25 Thrower Street, Reservoir	354.50	''	14/04/99
Industrial Pipeline Pr Products Pty Ltd, PO Box 405, Balwyn North	1,142.45	''	21/05/97
Gae Guseli, 170 Bellair Street, Kensington	212.00	''	20/10/98
Bruce William Kilpatrick, 61 Mount Pleasant Rd, Belmont	109.75	''	14/05/98
Amco Truck Parts Pty Ltd, Tynte, 44 Summit Drv, Bulleen	136.80	''	02/02/99
Men Extensions & Design Khoen, PO Box 66, Balaclava	222.30	''	05/05/98
Braeside Grove Pty Ltd, PO Box 1067, Ashwood	118.90	''	18/05/98
Davison Trading Service P/L, D 24 Nicholls St, Macleod	212.40	''	16/03/99
La Belle Femme, PO Box 265, Woori Yallock	458.55	''	23/12/98
Tony Cilicro Wrought Iron, 38 Adrian Rd, Campbellfield	152.35	''	18/06/97
Cholmeley Pty Ltd, Effective Negotiation Services, 830 High Street. Kew East	119.15	''	17/03/99
Jose Elizabeth, PO Box 70, Black Hill	108.25	''	08/12/97
Ms Lucy Casauria, 10 Greendale Rd, Doncaster East	205.05	''	16/06/98
Ms Carol, T/a Forty Meg Pencil, 17 Smith St, Thornbury	101.15	''	22/09/98
V. E. Lawrence, Apt 15. A. Abbots Street, Abbotsford	282.20	''	18/12/98
Margaret Theresa Mildren, 164 Hanson St, Corryong	128.20	''	28/04/99
John O'Mahoney, 21 Dixon Street. Echuca	146.80	''	29/01/99
Hayden Rees, 2 Stirling Crs, Glen Waverley	259.77	''	23/12/98
Allan Joseph Atkins, Frog Ponds Rd, Yea	145.10	''	31/03/99
Leanne Grace Stradling, 9 Taylor Crs, Traralgon	103.60	''	30/12/97
Cecila Spain, 41 Ocean Ridge Rd, Cape Woolamai	118.00	''	05/11/98
Tarro Ridge Pty Ltd, 135 King St, Bendigo	107.30	''	20/05/99
Rudi Elhajja, Suite 237, 16 Cotham Rd, Kew	117.75	''	31/05/99
Andrew John Hopgood, 52 Lynden St, Camberwell	104.40	''	17/06/99
Cliff Townsend, Unit 4, 30 Elgin Street, Morwell	103.90	''	12/04/99
Lorenzo Perito, 52 Gilbert Rd, Preston West	121.10	''	23/04/99
Jimmy Lai Goh, 840 Dandenong Rd, Caulfield East	168.25	''	30/06/97
Duncan MacKenzie, 1 Coniston St, Diamond Creek	130.00	''	08/12/98
Adam John Scholes, 31 Bible Street, Eltham	127.00	''	19/01/99
Susan Fleischer, 5 Toolang Crt, Mt Waverley	150.00	''	26/05/98
Debbie Castellano, 3 Kamona Crt, Altona Bay	120.00	''	18/05/99
Tots Club Childcare Centre, 249 High St, Templestowe	124.85	''	01/05/99
Fatima Hassan, 347 Station Street, Fairfield	120.30	''	04/06/99
J. Storey, 7-9 Frith Street, Wurruk	137.34	''	15/03/99
Nicholas Alexander Strong, Suite 2, 2 Henry St, Prahran	110.90	''	30/11/98
Robert Stanley Hammond, 2416 Warburton Hwy, Yarra Junction	100.00	''	18/12/98
Kirsty Hartney, 8 Murray Street, Cobram	172.60	''	14/11/97

Alder Keel Pty Ltd, T/a The Berm, Suite 106, 26 Queens Road, Melbourne	110.75	''	23/06/99
V. M. Leeming, 10 Muswell Hill Street, Glen Iris	104.35	''	08/05/98
Lisa Maree McMillan, Unit 3, 25 James St, Pakenham	130.00	''	20/04/98
Di Carlo Drainage Pty Ltd, 206 Yan Yean Rd, Plenty	196.40	''	30/03/98
Lesieli Vakauta, 24 Normdale Rd, Bentleigh East	259.25	''	29/10/98
GCB Eng. & Drafting Service, The Manager, P.O. Box 446, Moe	135.80	''	01/09/97
Colin Crossman, Horseland Saddlery Shepparton, 93A Wyndham Street, Shepparton	109.40	''	03/03/98
Remington Consulting Group Pty Ltd, Suite 409, 566 St Kilda Road, Melbourne	216.65	''	20/05/99
Trish Redman, 16 Grant Street, Clifton Hill	174.01	''	18/05/99
Zhijun Pan, 4 Chandra Avenue, Kilsyth	103.46	''	15/06/99
Lillian Gleeson, PO Box 158, Northcote	180.60	''	20/04/98
Georgina Collective Inc., PO Box 5386BB, Melbourne	172.50	''	04/09/98
Historic Port of Echuca, The Riverside Restaurant, 101 Murray Esp., Echuca	166.15	''	28/08/97
Shane Arnold Miller, RMB 1125, Yarrawalla Rd, Mitiamo	180.00	''	02/07/98
House of Marketing, 2-10 Fergusson Street, Abbotsford	196.08	''	07/08/97
Toorak Manor Pty Ltd, 22 Williams Road, Toorak	140.95	''	20/06/97
Craig Middleton, 539 High Street, Kew	128.05	''	29/12/97
Lynette Valerie Hickey, 91 Bridge Street, Benalla	137.10	''	13/01/99
I. A. Gaal, 23 Holden Street, Fitzroy North	118.00	''	06/05/99
Margaret Palmer, 12 Alfred Street, Preston	201.70	''	29/05/98
Pasquale Coladonato, Karinya Village, Unit 7, 22 Little Yarra Road, Yarra Junction	173.00	''	09/11/98
Nicholas Wright, Flat 1, 92 Main Rd, Lower Plenty	288.65	''	07/08/97
M.R.B. Nicholson, 805 High St, Thornbury	110.52	''	23/03/98
Melanie Hanna, Unit 12, 201 Gold Street, Clifton Hill	100.00	''	07/08/98
Mr Gary Walsh, Flat 2, 2 Wellington Street, Montmorency	340.15	''	02/08/96
Judith Anne Roulston, 32 Palmer Rd, Shepparton	105.70	''	07/06/99
Anne Downes, Ace Legal & Profess. Sec, 241 Toorak Road, South Yarra	123.65	''	25/01/99
Keith Brian MacDonald, 25 Cara Road, Highton	104.90	''	09/12/98
Karen McCann, 13 Grant Street, Oakleigh	100.00	''	31/08/98
Rodney Grant Newlyn, RMB 8460, Echuca	108.65	''	27/11/97
Phillip L. Milkins, PO Box 164, Glen Iris	289.32	''	11/12/97
D. G. Fitzgerald, 4 Bristol Crt, Glen Iris	125.90	''	28/09/98
Douglas R. Davie, PO Box 569, Seymour	185.75	''	05/05/97
Florigene Pty Ltd, 16 Gipps Street, Collingwood	240.75	''	10/03/98
Auto Training Board Limited, Attn: Beth Sywulsky, P.O. Box 71, Bundoora	202.52	''	31/10/97
Red Rooster Nat. Office, Janine Street, Scoresby	513.74	''	19/01/98
The German Shepherd Dog Council of Australia Inc., 6 Cratloe Road, Mt Waverley	103.55	''	29/06/98
S. M. Connolly, Speke Street, Raywood	150.00	''	08/10/97
Keith George Thomas, 34 Surrey Road, Warburton	125.95	''	23/06/99
Heather Lacey, 57 Talbot Crs, Kooyong	258.40	''	02/06/98
Peta Berry, PO Box 1089, Hartwell	127.20	''	24/06/97
Rosana Di Sisto, 13 Cloverdale Close, Burwood East	166.17	''	04/03/98
Ronald Paul Munro, 75 Manning Clarke Rd, Mill Park	100.00	''	01/12/98

Top Hat Liquor Supplies Pty Ltd, 199 Toorak Road, South Yarra	109.28	''	18/01/99
D. M. Telford, 27 Belsize Avenue, Carnegie	118.20	''	22/04/98
J. L. Clemenger, Unit 1 3 Tintern Ave, Toorak	299.40	''	02/12/98
Deborah Jayne Kent, 6 Leila Road, Warburton	153.85	''	31/07/96
Bampamg Parsanto, C/o Indonesian Consulate, 72 Queens Road, Melbourne	530.00	''	09/01/97
Garin Bice, 26 Littlejohn Road, Warranwood	155.05	''	25/01/99
Chris Bryan Hudson, 29a Banbra Rd, Caulfield North	410.66	''	27/08/97
Con Karambelas, PO Box 326, Preston	200.00	''	10/09/98
James Cayley, Flat 5, 30 Edmund St, Clifton Hill	106.98	''	15/09/98
Behrooz Teimoori-Moghaddam, PO Box 101, Blackburn South	146.60	''	11/03/99
Bruce Parncutt, 2 Kelmscott Road, Armadale	192.70	''	09/07/97
Ausker Pacific Pty Ltd, PO Box 353, Bulleen	100.00	''	02/12/98
Gary J. Walker, 2 Glass Street, Richmond	999.98	''	02/02/96
Lena Marouch, 24 Jessie Street, Preston	100.00	''	31/08/98
Geoffery W. Pember, 101 Princess Street, Kew	128.50	''	21/07/97
Juso Velagic, Unit 10, 165 Power Street, Hawthorn	550.48	''	22/07/97
Ballantyne Five Star Food Services, 1464 Ferntree Gully Road, Knoxfield	107.20	''	23/12/95
Arcade Embroidery, J. Campbell – TBF Billing, Locked Bag 27, Box Hill	435.80	''	10/12/98
Tradelink (Dandenong Southern), 46 Lonsdale St, Dandenong	150.00	''	08/03/99
House Group Footswilli Rooming Incorporated, PO Box 2251, Footscray	145.20	''	15/12/98
V C F I H Goulburn Intellectually Handicapped, Bowenhall Street, Shepparton	114.15	''	16/03/99
The Principal Korong Vale Primary School, Vernon Street, Korong Vale	102.37	''	21/07/98
William Noall Pty Ltd, 17th Floor, 360 Collins St, Melbourne	119.76	''	14/05/99
Melsteel Pty Ltd, 132-134 Abbott Rd, Hallam	435.00	''	04/06/99
Diane Isabel Andrew, 13 St Ives, Frankston	121.05	''	07/04/99
Australia Plastic Profiles, 71 Shearson Crs, Mentone	121.15	''	27/04/99
Lotserb Nominees Pty Ltd, 578 Doncaster Road, Doncaster	103.55	''	25/02/99
Triangle Cables Pty Ltd, 6 Chelmsford St, Kensington	321.55	''	16/02/99
All Timber Pty Ltd, 11-15 Hampton Ave, Sunshine	226.60	''	19/04/99
Domenic Karquinio, Shop 2, 95 Grimshaw St, Greensborough	159.20	''	07/06/99
Ansa Doors Pty Ltd, 71-73 Maffra St, Coolaroo	1,777.90	''	30/06/99
Paul Mason Pty Ltd, 1138 Mt Alexander Rd, Essendon	149.40	''	08/06/99
Village Bakery, Shop 3, 36 Mason Street, Warragul	399.65	''	21/04/99
Terminals Pty Ltd, Wharf Road, North Shore, PO Box 78, North Shore	328.04	''	11/02/97
Rachele Garden Supplies Pty Ltd, PO Box 4, Mooroopna	234.35	''	14/12/98
Rob S. British Butchers Pty Ltd, Shop 9, 9999-99999 Dandenong Arcade, Dandenong	121.45	''	04/01/99
Walter Oro, 79 Willis Street, Hampton	100.55	''	16/04/97
H. D. M. Mattingely, 4 Floor, Goodwood St, Richmond	270.44	''	05/01/96
George Patterson, Locked Bag 800, Footscray	236.95	''	25/11/94
St Nicholas Place Assoc Inc., C:- Richard Ellis (Vic) P/L, 101 Collins St, Melbourne	146.42	''	07/05/99
Flag Inns, T/a Super Sally, 150 Jollymont Rd, East Melbourne	223.41	''	07/08/97
Danks Holdings Ltd, 414 Lwr Dandeong Rd, Braeside	109.59	''	23/12/95

Planright Surveying-Harland & ????, 17 Nish Street, Echuca	356.80	''	22/01/98
Peterson Homes Pty Ltd, PO Box 50, Hallam	312.20	''	20/01/98
Min Metals Aust P/L, The Manager, 6th Floor, 580 St Kilda Road, Melbourne	117.96	''	11/07/97
Minmetals Australia Pty Ltd, Level 6, 580 St Kilda Road, Melbourne	200.60	''	19/02/99
Smith & Stone Pty Ltd, 197 Elizabeth St, Melbourne	239.07	''	27/04/99
Mr Rudolf Horvat, 63 Main Road West, St Albans	214.55	''	26/02/99
Bow Brickhill Corporation P/L, (Managed By TFM), PO Box 448, Ringwood	218.39	''	06/05/96
Rothschild Bros Pty Ltd, 121 Cremorne Street, Richmond	108.49	''	04/03/99
Kee Guan Saw, Level 5 118 Queens St, Melbourne	341.52	''	20/11/98
Georgetti, Nicholas Mr, 188E Barkly St, St Kilda	127.90	''	19/05/99
Bomac Engineering P/L, Factory 15, Mills Rd, Dandenong	182.90	''	10/03/99
Kingtree Pty Ltd, Shop 25, Lygon Piazza, 380 Lygon Street, Carlton	117.95	''	21/05/99
Australian Information Media, PO & S Division (Fm Billing), Private Bag 1111, Mulgrave	1,681.50	''	17/04/98
Luke Bolton, Cnr Tintern Avenue and Bayswater Road, Bayswater North	449.67	''	30/11/98
Susan Burt, 9 Ramu Pde, Heidelberg West	102.00	''	23/04/99
Microdot Computers Pty Ltd, 179 Springvale Road, Nunawading	132.25	''	10/11/98
Duresta Pty Ltd, Furniture Galore Hoppers Crossing, PO Box 140, Thomastown	423.35	''	02/11/98
Jerome Radcliffe Ernst, 18 Horace St, Sea Lake	121.60	''	20/11/98
Frances Rollinson, Post Office, Kalorama	120.15	''	29/05/98
Norm Francis Cox, 1 Belot Cl, Bayswater	100.00	''	24/06/98
Beverley Gladys Stevenson, 20 Panorama Rd, Herne Hill	200.00	''	23/12/98
Margaret Roy, 54/ 108 Greville St, Prahran	162.85	''	19/03/99
BP Australia Pty Ltd, C/o Joe Capparelli, MC29, GPO Box 52222BB, Melbourne	620.60	''	11/06/99
Adam Cindric, 5 Wigstone St, Noble Park	163.90	''	06/05/99
Rohan John Campbell, Unit 2, 55 Ormond Esp, Elwood	182.00	''	15/06/99
Rago Pty Ltd, Factory 3 5 Amsted Rd, Bayswater	112.60	''	06/11/98
Jenny Margaret Dalton, Flat at Rear 218 Thompsons Rd, Geelong North	100.00	''	30/09/98
L. Bolton, 197 Bayswater Rd, Bayswater	107.55	''	30/11/98
Salvatore Barba, 356 Bay Street, Brighton North	113.65	''	26/04/99
Blair Malcolm McGregor, 33 Imbros St, Hampton	147.70	''	27/01/99
Wunderman Cato Johnston Melbourne, Level 20, 60 City Road, Southbank	584.73	''	10/08/98
William Maurice Harrison, 14 Ballard St, Wodonga	141.90	''	24/11/98
Marcus Driver, 537 Waterdale Rd, Heidelberg West	251.45	''	20/03/98
(Aust) Pty Ltd Creative Sports, 37 Moore Street, Caulfield South	1,200.00	''	07/08/97
Greg Williams, 60-64 Vella Drive, Sunshine	245.08	''	15/02/99
Anna Sarraj T/a: Sarraj Carpets, 49 Peel St, West Melbourne	108.85	''	19/02/99
Mr Jeffery Priest, T/a: JRP Motors, Reserve Rd, Melton	111.30	''	17/05/99
Janine Antmann, 44 Cromwell St, Caulfield North	144.85	''	02/03/99
Numicom Aust P/L, 145 Keys Rd, Moorabbin	250.00	''	30/04/98

Executive & Professional Rety Ltd, Floor 11, 140 Queen Street, Melbourne	110.65	''	02/03/98
Mr R .C. Cooper, 30 Peppermint Grv, Knoxfield	221.20	''	15/04/98
Kinetic Concepts Pty Ltd, 94 Marianne Way, Mt Waverley	186.82	''	16/10/98
Garland Arch Pty Ltd, 14 Elsum Ave, Bayswater	109.40	''	10/11/98
Leonard Chemicals Products P/L, PO Box 241, Mt Waverley	273.00	''	22/09/98
Judy Elizabeth Rogers, 36 Irving Road, Toorak	130.30	''	18/02/98
Philip Matthew Harradine, Unit 5 137 Ford St, Ivanhoe	100.00	''	15/09/98
Mandy Lee Bennett, 386 Service Rd, Watsonia	205.90	''	08/12/97
3 H Holdings Pty Ltd, 172 Canterbury Road, Heathmont	142.70	''	16/03/99
M. P. Cross, 1197 Glenhuntly Rd, Glen Huntly	113.40	''	31/05/99
A. F. S. International Hanges, Unit 12, 233 Cardigan Street, Carlton	138.45	''	29/03/99
Brooke Williams, Unit 2, 8 Reserve Rd, Melton	148.10	''	22/04/98
Euro Design Interiors Pty Ltd, 3 St Kilda Road, St Kilda	491.60	''	15/12/97
A. Apostolou, 262 Lum Road, Mulgrave	157.10	''	18/12/98
L. & G. Rogers Bros Pty Ltd, PO Box 267, Bayswater	100.00	''	07/06/99
Mary Ellen Kennedy, 4 Portland St, Norlane	304.35	''	08/08/98
Rosalie Marsh, 27 Hillson Grove, Ocean Grove	107.90	''	27/01/99
Larissa Ann Jones, PO Box 72, St Kilda	108.95	''	08/04/99
B. D. Burggraaf, 12 Sutton Street, Carlton North	313.25	''	12/03/99
Luana Marie Cutifani, 34 Clude St, Surrey Hills	428.00	''	25/08/97
Paul & Pauline Anne Eyries, 22 Blackwood Drive, Melton South	145.50	''	11/06/99
Mr Andrew Hastas, 141A McKinnon Road, McKinnon	180.00	''	07/08/97
Aust Regional Health Group Ltd, 16 Varzin Avenue, Surrey Hills	356.55	''	13/06/97
Sportsworld Holdings Pty Ltd, Building 15, Rosella Complex, 64 Balmain Street, Richmond	126.90	''	05/04/93
Eliette Coller, 66 Bendigo St, Richmond	119.50	''	22/05/97
Royal Mist Pty Ltd, Level ,3 650 Chapel St, South Yarra	193.10	''	23/05/95
Lionel Chiew, 2E Princess St, North Melbourne	146.60	''	10/03/99
Janet Hall, Aust Ind Rels Comm, GPO Box 1994S, Melbourne	118.68	''	17/02/99
Rudolph Urbans, Flat 121, 127 Gordon St, Footscray	100.00	''	28/10/98
The Accountant, Melton Market, PO Box 23, Melton	105.00	''	12/11/98
Edward Carmicheal Aboriginal Trust, Rules Rd, Lake Tyers	130.00	''	20/08/98
Barry C. Caulfield, 6 Bushview Glade, Boronia	128.85	''	12/11/98
Jim Emilio Santamaria, 4 Fairview Ave, Wheelers Hill	103.70	''	29/06/99
Hugh Sijbers, C/o State Trustees, GPO Box 1461N, Melbourne	108.70	''	22/07/98
Yin Quan Lynette Chung, Unit 5, 198 Grange Road, Glen Huntly	118.87	''	20/05/97
Midas Australia Pty Ltd, 208 Princes Hwy, Pakenham	167.40	''	15/05/98
Texas Pete Pty Ltd, PO Box 1, Ormond	140.05	''	28/01/99
Kin Wong, Unit 15, 230 Abbotsford Rd, North Melbourne	738.40	''	30/04/98
Wayne Haggar, 77 Hargrave Ave, Essendon Airport	380.50	''	04/03/98
Lydia Kiria, Unit 2/57 Centre Dandenong Rd, Dingley	192.95	''	05/03/99
B. W. Eagle, 549 Mountain Hwy, Bayswater	138.00	''	15/08/98
Engineering By Design Pty Ltd, 29 Avonhurst Drv, Glen Waverley	327.85	''	01/11/97
Athanasios Mougos, 1 Cooper St, Springvale	118.65	''	23/11/98
Eve Rupik, Flat 3, 4 Holloway Street, Ormond	150.00	''	14/07/98

Lisa Jane Harris, 22A Pine Court, Boronia	288.35	''	18/06/98
Ann Hogan, 8 Megan Close, Cranbourne	110.50	''	10/12/97
Paul Christopher Mance, 1 Weemala Crt, Bayswater	110.00	''	10/01/97
Eliza Tree, 73 Illawarra Road, Hawthorn	159.00	''	06/11/98
Gadens Ridgeway, 385 Bourke Street, Melbourne	153.73	''	05/01/96
All Trans International, The Accountant, Market Street, P.O Box 73, Melbourne	1,331.75	''	26/02/97
American Cycle Supply Pty Ltd, 825 Nepean Hwy, Brighton East	320.90	''	06/05/99
Kings Funeral Services P/L, 25 Myers, Geelong	104.55	''	08/10/98
Yusen Daly Smith International, 1-3 Clarice Rd, Box Hill	149.10	''	01/11/95
KMP Holdings Pty Ltd, T/a Victorian Imaging Group, PO Box 279, Mentone	182.05	''	11/03/99
Jeffrey Lawrence Harrington, C/o Unit 2B, "Lonsdale Heights", 131 Lonsdale Street, Melbourne	175.45	''	07/08/95
Calman Australia Pty Ltd, 90 Fairbank Rd, Clayton	119.11	''	07/08/97
New England Office Systems Pl, Recvr Mngr Apptd Pre Debt, PO Box 711, Glen Waverley	427.25	''	15/10/98
Darca Cleaning Pty Ltd, 12 Bellevue Ave, Rosanna	146.20	''	12/04/99
Bizplay Pty Ltd, 68 Park Street, Moonee Ponds	115.60	''	16/09/98
John Costi (C&C) Shop 2, 109 Lava Street, Warrnambool	119.15	''	05/05/99
Tucker Boemo Pty Ltd, 4-8 Chapel Rd, Keysborough	225.95	''	15/02/99
Elizabeth Mary Phillips, 45 Donald Street, Langwarrin	468.82	''	10/03/98
Scott Andrew Davenport, 16 Bristol Ave, Chelsea	100.00	''	23/10/97
Bulls On The Tambo Hotel, Princes Hwy, Swan Reach	518.09	''	18/02/99
Danda Nominees Pty Ltd, T/a The Space Place - Kilsyth , 46-48 Orchard Street, Kilsyth	118.20	''	19/01/99
John Bodin Photography Pty Ltd, C/- K. Reynolds, PO Box 299, Ballarat Private Boxes	156.54	''	12/11/97
Bauch, Terry Mr, 31 Technical Drive, Craigieburn	720.25	''	17/03/99
Newcorp Pty Ltd, T/a Bonney Leder Studio 3, 663 Victoria Street, Abbotsford	387.55	''	03/03/99
Intramr Pty Ltd, PO Box 1050, Tullamarine	1,179.15	''	31/05/99
Terminals Pty Ltd, PO Box 268, Footscray	111.67	''	08/11/96
Grantley Bingham Stables, Mr G, Stables, PO Box 753, St Kilda Road, Melbourne	118.53	''	19/02/96
Aaron Douglas Bell, PO Box 381, Rosebud	310.65	''	02/05/96
Mr Gregory James Hoyle, 9 Cedar Street, Newham	108.55	''	11/02/97
Pajero Hotels Pty Ltd, 14 Moris Street, Maldon	117.50	''	10/11/98
Heatherton Sanitorium, Kingston Rd, Heatherton	122.33	''	01/05/98
Mitchell R., 81 Lucan Street, Bendigo	149.55	''	23/03/99
Natalie Mardling, 488 Victoria St, North Melbourne	115.25	''	07/06/99
Cafe Fiore, 279 Clarendon Street, South Melbourne	181.85	''	19/10/98
Oriental Food Fair Pty Ltd, Shop 159, Gladstone Park Drive, Tullamarine	133.00	''	13/01/98
Global Metal Recovery Pty Ltd, Unit 2, 15 Atkins St, Kew	415.25	''	30/11/98
W. H. Glen, PO Box 643, Mansfield	120.55	''	12/08/97
Mod Cons, Locked Bag 800, Footscray	755.50	''	19/11/98
Swan Hardware & Staff Pty Ltd, 248A Hoddle Street, Abbotsford	141.65	''	19/01/98
Club Fogolar Furlan Pty Ltd, 1 Matisi Street, Thornbury	179.10	''	21/12/98
Rutledge Engineering Pty Ltd, 7th Floor 55 King Street, Melbourne	243.50	''	01/07/98

Federated Brick Tile & Pottery, PO Box 80, Brunswick East	112.75	''	15/10/98
John Rocchi, 282 High Street, Northcote	113.25	''	17/02/99
R. Jolevski, 211 Separation Street, Northcote	101.28	''	23/06/99
J. & J. Listern Pty Ltd, Ballarat Sand Soil & Sleeper PO Box 102, Wendouree	1,025.65	''	03/02/99
Simon Coombe, 7 Cratloe Road, Mt Waverley	100.00	''	23/09/97
Jerome Haoust, 2 Highmont Drive, Vermont South	108.60	''	09/09/97
Leonard Kempler (Sole Trader), 5 Muntz Street, Caulfield North	168.55	''	26/02/99
Janet Marks, 377 Wattletree Rd, Malvern East	122.75	''	20/03/99
James Arthur Wood, PO Box 24, Ferny Creek	230.80	''	27/10/98
Institute of Patent Attorneys, 1 Little Collins St, Melbourne	172.09	''	24/12/98
Systems Ken Allen, T/a Aluminium, 10 Fenwick St, Kew East	102.75	''	07/08/97
Sharon Rosa Gelb, Unit 4, 119 Victoria Rd, Hawthorn East	138.60	''	22/02/99
Metropolitan TV Hire Pty Ltd, P.O.Box 60, Malvern	106.94	''	29/12/98
M. P. Turner, Unit 4 9 Petrie Street, Frankston	200.00	''	11/11/98
Kathlyn Gibson, 8 James Street, Northcote	139.73	''	11/01/99
Mr Cem Yasa, (Final Account) 724 Nicholson Street, Fitzroy North	103.70	''	22/03/99
John Edward Essex, 134 Finch Street, Malvern East	104.05	''	24/02/99
Mr John Gemmil, Inverloch Natural Therapies, PO Box 289, Inverloch	152.45	''	30/06/99
Roderick Norman Hunter, 7 Wilkinson Way, Park Orchards	119.20	''	13/10/98
Shayne Norval Madder, 86 Tram Rd, Doncaster	906.25	''	17/02/99
Mr Micheal Deenen, PO Box 296, Inverloch	229.35	''	07/04/99
Caroline Cleaver, 60 Freeman Street, Fitzroy North	108.35	''	08/12/98
K. Dueringe, 1 Wattle Crt, Forest Hill	112.25	''	25/02/99
Hosemans Jason Chris Alexander, T/a Ian White Pharmacy, 137 Barkly Street, Ararat	403.95	''	18/01/99
MCK Hollway Kenilworth, Midland Hwy, Sulky	219.60	''	19/01/98
Cherie Alderson, 37 Amery Ave, Blackburn	269.80	''	08/07/97
A. Goucher, Flat 5 7 Stevens Rd, Vermont	127.65	''	30/08/96
Sang Hong, Unit 6, 847 Burwood Rd, Hawthorn East	102.17	''	11/02/98
Michael John Pepyat, 5 Sylvan Crt, Forest Hill	188.60	''	25/05/98
R. D. Date, 16 Ryan Street, Seaford	105.35	''	16/04/98
Andrea Elizabeth Seager, 9 Billing Street, Mount Waverley	180.45	''	15/09/97
Phillip Alexander Urquhart, 14 Westbourne Gr, Camberwell	132.90	''	20/02/99
Andrew Grech, 2 Glen Drv, Eaglemont	201.55	''	17/03/98
Matthew Scott Corkin, Unit 2 13 Vasey St, Mt Waverley	109.65	''	25/01/99
Everdrill Pty Ltd, 51 Valencia Street, Glenroy	250.00	''	10/07/98
Douglas Holmes, Flat 24, 27 Caroline St, Hawthorn East	205.35	''	15/02/99
Mobile Radio Fitting Co, Andrew, 77D Miles Gr, Seaford	248.80	''	07/08/97
Rob Lehmann, Cnr Camp & Sturt Street, Ballarat	145.55	''	04/01/99
Robyn Cornell, Unit 10, 64 Callander Rd, Noble Park	105.00	''	07/04/98
Barbara Johnstone, 10 Kipling Pl, Karingal	100.00	''	17/09/97
Ashley Dean Hadfield, Unit 3, 31 Rathmines St, Fairfield	113.85	''	11/11/98
Brian David Harrison, Lot 19 Warranga Street, Nerrina	132.80	''	25/02/97
Jacqueline Peta Kearns, 3A Broomfield Rd, Hawthorn East	128.63	''	10/05/99
James White, 34 Peel Street Sth, Ballarat	129.25	''	27/03/97
Erika Esther Kimpton, 17 St Georges Rd, Armadale	185.50	''	11/07/97
David Tikotin, 339 Canterbury Rd, Forest Hill	100.00	''	22/02/99

Joe Sozanki T/a Caught On Film, 22 Truman Crt, Altona Meadows	187.95	''	24/03/99
Rachel Margaret Anne Montague, PO Box 6061NDC, Doncaster	124.20	''	21/07/97
Stuart Dalton, PO Box 237, Rosanna	178.00	''	27/04/98
Jane Elizabeth Grano, 14 Linum Street, Blackburn	120.30	''	18/02/99
Sylvia Heidi Dolezal, Unit 1, 3 Frame Ave, Tecoma	102.80	''	10/05/99
Apex Sewing Machines P/L, 323 Keilor Rd, Essendon	116.29	''	12/05/99
Dennis Brooks, 10 Sutherland Street, Clunes	185.55	''	06/11/98
David Reynolds Eaden, 14 Laurie Ave, Tecoma	165.60	''	30/06/99
Lindsay David Davies, 8 Park Street, Inverloch	127.10	''	06/08/98
Susan Day Cakes Pty Ltd, 219 Auburn Rd, Auburn	179.85	''	08/02/99
Kronen Woodcrafts Pty Ltd, Lot 31, Cumberland Drv, Seaford	247.50	''	21/12/98
Paul Allen Smart, Unit 8, 34 Fermanagh Rd, Camberwell	106.55	''	23/04/99
Corinne Hoebert, 26 Senacre Street, Strathmore	100.30	''	28/05/99
Icaa & Atug, Unit 2, 272 Orrong Rd, Balaclava	298.75	''	13/02/97
Rebecca Calderazzo, 77 Isabella Street, Geelong West	117.95	''	24/10/96
Jenny Van Haandel, 14A Judd Street, Camberwell	400.15	''	27/06/97
Matthew Alexander Larkin, T/a Spurling Formal Hire, Suite 278, 45 Glenferrie Road, Malvern	153.65	''	05/01/99
Trevor Jones, 35 The Ridge, Canterbury	159.95	''	12/04/99
Kaye Louise Heaslip, 53 Vicki Street, Forest Hill	165.40	''	31/03/98
Morag Millar, T/a Excalibur Catering, Top Floor, 1 Edsall Street, Malvern	150.00	''	16/12/98
Geoffrey Brown, Flat 2, 831 Burwood Rd, Hawthorn East	200.00	''	15/04/98
Joan Victoria Molloy, 25 Candlebark Cres, Frankston	140.00	''	18/03/99
Ann Elizabeth Cass, 14 Wingrove Street, Forest Hill	120.45	''	27/02/99
Mitis Fleur Pty Ltd, The Accountant, Mitis Fleur Pty Ltd, 2-6 Market Street, Nunawading	308.70	''	18/06/99
Michael Kevin Green, PO Box 186, Inverloch	143.20	''	01/10/98
Scott Charles Fischer, 4 Crimea Street, Burnley	100.00	''	01/02/99
Mr John M. Westwood, 139 Ballarto Rd, Carrum Downs	105.25	''	05/02/99
Bruce Wen, Unit 5, 65 Rathmines Street, Fairfield	564.35	''	07/08/97
Michelle Christine Sinner, Flat 5, 49 Beavers Rd, Northcote	121.60	''	14/11/97
William Henry Muir, 124 Artherton Rd, Northcote	200.00	''	26/05/99
Aron Ladoratories Pty Ltd, 21 Kitchen Rd, Dandenong	204.65	''	02/06/98
Kendra Louise Hounsell, 27 Coogee Ave, Frankston	100.25	''	11/11/98
Vanessa Reynolds, Flat 1, 39 Grange Rd, Fairfield	140.00	''	26/02/99
Delvene Francis Phease, Unit 3, 23 The Avenue, Upwey	110.00	''	11/04/97
Kimberley Louise Mannix, 21 Stanhope Street, Malvern	113.75	''	23/03/99
Mr J B Stefani, 2 Sumner Street, Brunswick East	120.75	''	17/05/99
Rathmines Clinic, T/a Rathmines on Bourke, 1035 Burke Road, Camberwell	140.40	''	11/11/97
Mr T. W. Davey, 323 Victoria Rd, Thornbury	202.95	''	03/04/98
Miss Glenda, T/a Ahead For Hairs, 2/64 Whitehorse Rd, Blackburn	104.30	''	09/12/98
Alex Infuso, T/a Symphony Florist, 1 Fernbrook Way, Templestowe	462.50	''	22/07/98
Raeshell Pty Ltd, 69 Frawley Rd, Hallam	158.85	''	07/09/98
Tessie Massey-Chase, C/o Coalfields Caravan Park, Sit 15, Graham Street, Wonthaggi	110.00	''	20/02/98

Elsa Balbuena, Flat 1, 25 Bambra Rd, Caulfield North	150.00	''	31/07/98
Sandford Dale Pty Ltd, Unit 5, 13 Eastbridge Crt, Nunawading	135.00	''	17/12/98
Greenvale Geriatric Centre, North West Hospital, PO Box 7000, Carlton South	266.16	''	07/09/98
State Emergency Service, PO Box 69, Bacchus Marsh	132.16	''	16/06/98
Warrnambool Base Hospital, Ryot Street, Warrnambool	664.10	''	10/05/98
The Principal Stawell Secondary College, PO Box 202, Stawell	206.14	''	14/08/97
Vista International Hotels Ltd, 215 Lt Collins Street, Melbourne	1,919.73	''	07/06/98
National Directory Services, 20 Henderson Rd, Unit 1, Knoxfield	152.00	''	08/10/98
Boart Australia Ltd, Boart Aust P.L, 36-40 Northern Road, Heidelberg West	1,336.99	''	07/04/95
Purtills Nursery Pty Ltd, PO Box 886, Bendigo	203.85	''	25/09/97
Mildred Griffiths, PO Box 164, Merbein	127.20	''	08/10/98
Shaun Aplin, 18 Thorpe Street, California Gully	147.20	''	11/06/97
J. R. Tragear, PO Box 486, Echuca	112.45	''	18/02/99
Tony Doumanis, Flat 13, 79 Ormond Rd, Elwood	119.80	''	20/01/99
Stewart Dickson, Factory 3, 9999 Grantville Dr, Grantville	171.50	''	24/11/98
Kensington Hotel Pty Ltd, 2 Boundary Road, North Melbourne	119.05	''	15/02/99
Chi Uy Dam, 8 Enfield Pl, Forest Hill	137.30	''	27/05/98
Peter Riley, 890 Deptford Road, Clifton Creek	200.30	''	30/06/99
Robinvale Euston Tourist Infor., Robinvale Pharmacy, Perin Street, Robinvale	175.95	''	03/02/99
Gowrie Juliana Muniandy, 105 Turramurra Drv, Rowville	100.95	''	05/02/99
J. L. & L. McCann Pty Ltd, 100 Goulburn Rd, Echuca	125.75	''	27/03/98
W. P. G. & H. E. Long Pty Ltd, T/a Mahoneys Supermarket 2139, 15th Street, Irymple	137.30	''	29/12/98
Maree A O'Riley, 19 Banfield, Ararat	113.85	''	15/07/98
Mr Frances Edward Frost, C/- Mr F. E. Frost, 1464 Koorlong Avenue, Irymple	127.29	''	26/05/99
Jamie Joseph Tobin, 407 Raglan Street, Ballarat	648.60	''	25/03/99
Lisa Jane Boss, 3 Holden Street, Maryborough	110.80	''	29/05/98
Carizma International Pty Ltd, Suite 10, 350 Victoria Street, North Melbourne	450.65	''	14/04/99
Leslie Alfred Pitt, 14 Hospital Street, Daylesford	200.00	''	10/05/99
Riverside Pumps, Mr Douglas Pumps, 68 Bond Street, Mordialloc	255.35	''	19/09/97
The Cheese Cake Shop, 196 Lower Dandenong Rd, Mordialloc	176.00	''	09/11/98
Mouzaya Pty Ltd, 77 Great Ocean Rd, Apollo Bay	471.05	''	15/12/98
Roy Francis Richards, 48 Williams Rd, Mt Eliza	108.20	''	21/09/98
Shannon C. Johns, Unit 1, 83 Annesley Street, Echuca	145.90	''	05/08/98
Mr Varin, T/a Le Croissant Des Halles, 507 Elizabeth Street, Melbourne	139.75	''	08/12/98
H. Barrott, 7 Howard Ct, Glenroy	101.00	''	11/03/98
Products P/L Boss Admin Apptd (Pre Debt), PO Box 781, Dandenong	291.75	''	01/12/97
David Geoffrey Falkingham, PO Box 65, Avondale Heights	148.33	''	16/04/98
Wayne Shepard, 129 Curdie Street, Cobden	659.55	''	28/05/99

Ena Smith, Unit 6, 3 Baker Street, Kaniva	115.00	''	10/07/98
Dunning Petroleum Pty Ltd, T/a Jet Beaconsfield, 122 Old Princess Hwy, Beaconsfield	132.30	''	12/05/99
Barbara Anne Gathercole, 17 Kalimna Dr, Mornington	142.35	''	06/04/99
Stephen Wellard, 7 Narveno Crt, Hawthorn	174.15	''	08/06/99
Tony Pollard, 4 Sturt Street, Sunbury	100.00	''	25/06/98
Joely Ann Cameron, 12 Sabato Street, Rye	148.25	''	13/05/98
Vinod Kumar, 14 Callistemon Rse, Mill Park	135.33	''	19/12/98
Fotoula Besanko, 5 Hopetoun Av, Mt Martha	103.15	''	28/06/99
Barry O'Sullivan, 63 Beaconsfield Rd, Emerald	127.90	''	01/04/99
Ideal Sweets, 11 Roosevelt Street, Coburg North	158.15	''	05/08/98
Mr James Andrews, PO Box 564, South Yarra	130.53	''	01/05/98
Diana Veronica Siewert, Unit 2, 6 Collingwood Street, Rye	120.55	''	18/10/96
Anthony William Cockerell, 1 Swindon Court, Lara	152.10	''	18/04/99
Kim Michael Gration, Cressy Rd, Beeac	156.70	''	09/10/98
Kathleen Johnson, 22 Caxton Street, Blairgowrie	103.90	''	30/06/99
Bruce William Redpath, PO Box 110, Berwick	277.30	''	27/11/96
Jennifer Davies, 23 Yarrabin Drive, Mt Martha	121.35	''	30/10/98
Robert MacKenzie, Mitchell Rd, Echuca	191.90	''	21/11/97
John William Falter, 16 Tisdall Rd, Kyabram	266.35	''	18/08/97
Robert Andrew Lowe, 2A Neill Street, Berwick	145.35	''	07/11/97
Greg Dimattina, 8 Nordic Ave, Taylors Lakes	119.30	''	31/05/99
Norman Cross, 14 Vale Street, Mornington	100.00	''	30/10/97
Cover Up Canvas Products, 12 Damosh Ave, Carrum Downs	115.00	''	23/10/98
Simply Hydroponics, Ms Casa, T/a Simply Hydroponics, Fact 2, 399-401 Old Geelong Rd, Hoppers Crossing	137.50	''	19/05/99
Paula Mackie, 14 Dean Street, Hawthorn	204.75	''	13/02/98
Mr Jim Irme Szabo, 44 Yeneda Street, Balwyn North	110.60	''	08/09/98
Andrew Francis McPhee, 30 Rocklea Drv, Torquay	100.00	''	29/10/98
Trece Tagle, 1 Betts Way, Burwood East	219.75	''	16/12/98
John Scaltsas, PO Box 577, Balwyn North	235.95	''	17/12/97
Loraine MacReadie, 105 Beaumont Rd, Berwick	154.65	''	24/03/99
Mr Leon Grimble, 28 Moona Street, Burwood East	120.75	''	08/10/96
David Norman Jenkinson, 33 Winswood Cl, Vermont	520.00	''	23/04/98
Meighan Warren, Unit 1, 55 Monash St, Box Hill South	100.00	''	16/05/97
Nora Adams, Rear 736 Highbury Rd, Glen Waverley	120.00	''	06/02/98
Bridget Monica Giles, 3 Eagle Farm Crt, Keilor Park	100.00	''	19/11/96
Robin Frater, Lot 23, 100 Williams Rd, Launching Place	265.65	''	27/02/98
Shane William Warren, 15 Vasey Gr, Mitcham	150.00	''	25/04/99
John Patrick Good, Schear Street, Barmah	136.50	''	25/02/99
Simon Grain, PO Box 125, Glen Iris	154.50	''	21/10/98
Phillip Thorn, 9 Daimler Ct, Epping	160.00	''	06/05/99
Michael John Nolan, 11 Rose Blvd, Lancefield	100.00	''	17/11/97
Tina Caruana, 37 Oaktree Drv, Hampton Park	134.70	''	12/04/99
John Kemp (Sole Trader), T/a Pro Image Concepts, 85 Dobell Avenue, Sunbury	110.05	''	31/10/97
Mr R. Vurmeski, Lot 44, (No 3) Cosma Crt, St Albans	139.00	''	04/12/98
Joe Mifsud, 2211 Nepean Hwy, Rye	122.00	''	02/02/99
Mr William C. Muller, 30 Cozens Rd, Lara	120.00	''	10/03/99
Melissa Clark, 9 Silvereye Pl, Morang South	138.20	''	14/04/99
Elain Joy Cambrey, 97 Hawkes Drive, Mill Park	300.00	''	27/03/99
Elizabeth Mary Tilley, 165 Barkley Street, Mornington	108.70	''	12/03/99
Wykbond Pty Ltd, PO Box 29, Taylors Lakes	133.00	''	08/07/97

Geraldine Anne Jenkins, 212 Eddy Ave, Mount Helen C. V. Flowers, C/o Mrs J. McGrath, 32 Wright Street, Heathcote	192.45	''	21/04/98
Mr Geoffrey Alexander Branch, PO Box 232, Torquay	100.85	''	18/11/98
Richard Johnson Nabb, 17 Sutherland Rd, Armadale	156.10	''	02/03/99
Ivan Gibson, 164 Eungower Rd, Somerville	109.50	''	13/02/99
Alan Victor Wilkinson, (Sole Trader), PO Box 275, Vermont South	326.00	''	21/12/98
Tanya Maree Stewart, 44 Seaby Street, Stawell	238.30	''	17/03/99
Sing Dang, 7 Fernlea Crt, Ardeer	142.15	''	17/06/99
Jennifer Elizabeth Calleia, 8 Bemersyde Drv, Berwick	116.70	''	01/07/97
Jean Steiner, 3 Courang Rd, Glen Iris	119.55	''	08/01/98
Archibald Friece, C- Ms L. Roberts, 19 Oxford Street, Burwood	159.55	''	30/04/97
Roman D. Nikolaev, Flat 7, 14 Markham Ave, Ashburton	144.60	''	08/02/99
Deborah Peggy Nightingale, 51 Playne Street, Heathcote	193.50	''	19/03/96
Rhys Anthony Humphreys, 15 Campbell St, Glen Waverley Omegatrend Pty Ltd, Member of Omegatrend Pty Ltd, 14 Garfield Crt, Hampton Park	125.10	''	10/07/97
Julie Matusko, 8 Harcourt Cl, Sunbury	182.82	''	07/04/99
Pondok Laguna Pty Ltd, Unit 4, 422 Middleborough Road, Blackburn	175.00	''	28/02/97
Sharon Peart, 13 Bodmin Ct, Craigieburn	142.20	''	24/07/97
Karen Linda Garratt, Unit 4, 57 Warwick Rd, Pascoe Vale P. & C. Communications, Administrators Account, PO Box 781, Dandenong	196.60	''	29/11/98
Olympia Kostas, 204 Elizabeth Drive, Sunbury	250.00	''	10/10/97
Stephen Frances McDonnell, 545 Baxter Tooradin Rd, Pearcedale	425.00	''	08/06/99
E. Beale, Shops 4 & 5, 1 Grange Road, Toorak	108.48	''	13/12/97
Aust Surfriders Assoc Vic., Surfcoast Plaza, Shop 11, Geelong Road, Torquay	144.90	''	28/01/99
Elizabeth Jane Littlejohn, 364 Dundas Street, Rye	337.00	''	01/08/97
Donald James Barnes, Unit 94, 287 Bayview Rd, Rosebud	112.97	''	23/06/99
Shayne Anthony Sanders, PO Box 141, Kerang	215.60	''	16/11/98
Allan Watt, Unit 3, 6 Clement Ct, Mill Park	135.60	''	21/12/98
Kim Coburn, 1 Shrewsbury Rd, Nunawading	107.93	''	17/03/99
Jemma Manifold, 45 Lyons Street, Rye	177.70	''	28/08/97
Elizabeth Ryan, Lot 170, 16 Heysen Drive, Sunbury	200.00	''	07/01/98
J. L. Gorfine, PO Box 257, Buninyong	112.55	''	29/04/99
Edge Commercial Interiors Pty Ltd, 32 Webber Pde, Keilor East	600.00	''	18/06/99
Isidoro Taranto, 9 Plover Ct, Patterson Lakes	137.25	''	06/04/99
Program Carpet Maintenance Pty Ltd, P.O Box, Hawthorn	100.00	''	16/04/98
Sean Edington, 15 Yuilles Road, Mornington	238.15	''	22/04/99
Melanie Jane Blundell, Unit 4, 8 Fair Street, Shepparton	139.10	''	20/03/98
Geoffrey W. Sharp, Unit 1, 208 Corio Street, Shepparton	140.40	''	23/12/98
Judith Ann Lavia, 16 Wellington Street, St Albans	139.02	''	30/04/99
David Panter Marshall, PO Box 114, Mt Macedon	100.00	''	10/09/98
Nellie Margaret Hocking, Unit 4, 10 Stanley Street, Brighton	110.00	''	06/01/98
Peter Ward Kendall, 155 Main Rd, Campbells Creek	104.60	''	26/08/98
	126.30	''	06/04/99
	133.85	''	16/09/97
	156.95	''	03/03/98

Deborah Jean Everett, Opp Cummins Drive, Howes Creek Rd, Mansfield	165.95	''	23/05/97
Peter Rudolph, 30 Panoramic Rd, Balwyn North	170.30	''	06/04/99
Angela Edwina Cameron, 52 Robertson Street, Morwell	160.00	''	07/08/98
Maine International, 13 Hall Street, Hawthorn East	302.22	''	19/09/97
Domino River P/L, PO Box 126, South Melbourne	386.66	''	01/02/99
Malcom Leech, 1 Elizabeth Street, Castlemaine	185.35	''	28/04/98
Mr B. J. Maher, 59 Goegan Street, Werribee	174.25	''	14/10/97
Mr R. I. McVilly, PO Box 19, Timboon	117.15	''	25/03/99
Promo Corp Pty Ltd, 126 Albert Rd, South Melbourne	100.35	''	28/07/98
Fleming Civil Engineering Pty, 14 Nelson St, Moorabbin	233.30	''	24/02/99
Muzicom, 8 Dummett Cres, Clifton Hill	103.75	''	04/08/97
Sharon Wilmont, 78 Mcilwraith St, Carlton	270.20	''	25/06/99
Mr H. T/a Eastern Court Restaurant, 123-125 James Street, Templestowe	121.40	''	06/03/99
Per Norman, 2 Haldane Crt, Doncaster East	555.50	''	18/01/99
Adams, Murray H. T/a Fone I.D., 172 Flinders Lane, Melbourne	100.00	''	''
Andrew William McQualter-Whyte, Telford Rd, Burringone	109.05	''	17/07/97
Jillian Humphrey, 20 Templestowe Rd, Bulleen	154.45	''	25/11/98
Salefest Pty Ltd, 1000 Nepean Hwy, Moorabbin	108.75	''	11/11/97
Terence Leigh Elliott, 7 Lyle Ct, Goughs Bay	110.90	''	11/05/98
Dolphin Research Institute Inc., PO Box 1245, Frankston	147.45	''	30/06/99
Philip Otene Rakena, Mq 50067, 67 Catalina Ave, Sale	523.51	''	27/10/98
Anita Ellan Boyle, 26 Alfada Street, Caulfield	143.57	''	17/06/99
Michelle Louise Jackson, Unit 2, 1298 Main Rd, Eltham	138.75	''	12/06/99
Gail May, 13 Rosemary Crt, Yarrowonga	180.20	''	29/01/99
Jamie Campbell, Shop 206, 241 Main Street, Mornington	232.95	''	27/10/98
Gleason Cranes Pty Ltd, Administrators Acct (Final), PO Box 216, Toorak	534.70	''	12/03/99
Martin Lee Springvale Pharmacy, Shop 13A, 46-58 Buckingham Ave, Springvale	145.10	''	12/02/99
Mark Charles Tollitt, Factory 7, 417 Warrigal Rd, Moorabbin	237.55	''	14/05/98
P. Adams, RMB 5845, Wangaratta	322.89	''	31/07/98
John David Hanna, 4 Dewpond Court, Templestowe	166.85	''	12/10/98
Michael Hatfield (Sole Trader), 17 Gleneagles Ave, Mornington	122.25	''	11/03/99
Faye Crozier, 46 Blackburn Rd, Doncaster East	120.00	''	04/07/97
Maxwell Charles Fordham, 67 Bellevue Ave, Doncaster East	109.30	''	15/07/98
Barbara Christine Lloyd, 27 Damian Crt, Cranbourne South	282.25	''	27/11/98
Daniel J. Croucher, 101 Bayswater Rd, Kensington	266.60	''	01/12/98
Paul Francis Fox, PO Box 655, South Melbourne	100.00	''	07/08/97
Pauline Marjorie Larsson, Unit 6, 15 June Crs, Templestowe	251.00	''	14/05/96
Simon James Boag, 7 Charles Street, Hampton	215.40	''	03/02/99
Zanie Pattison, C/- Post Office, Research	172.90	''	09/10/97
Frederic Edmond Poliart, 42 Vernal Ave, Mitcham	252.95	''	29/05/99
Timothy David Newhouse, Unit 1 45 Frank Street, Eltham	100.00	''	12/05/99
Albert Paul Butera, 2/17 Teton Crt, Highett	116.55	''	24/04/98
Richard Armstrong (Sole Trader), 12 The Concord, Bundoora	106.75	''	06/01/99
Peter Michael Collins, 13 Passchendaele Street, Hampton	143.05	''	27/03/98
Marie Joy Turnbull, 12 Greenock Street, Reservoir	179.95	''	21/04/97

Cindy Dianne O'Brien, 11 Yorta Yorta Drv, Barmah Town	162.05	''	25/03/99
Paul Turner, 20 Hastings Ave, Blackburn South	148.00	''	25/05/99
Robert Lindsay Pemberton, Strathbogie Rd, Merton	149.75	''	18/05/99
Strasburger Enterprises P/L, GPO Box 4239, Melbourne	171.40	''	23/10/96
Myffanwy Gaye Marrows, 14 San Remo Rd, Ringwood	190.85	''	14/11/97
Tracey Bode, 96 Station Street, Port Melbourne	126.00	''	09/10/98
Lina Angela Masiero (Sole Trader), Lot 54, Harptree Cl, Rowville	322.90	''	27/04/99
Carmela Lynch, 30 Blake Street, Wangaratta	250.00	''	11/01/99
Verna Williams, Unit 1 12 Dunn Street, Benalla	100.00	''	15/07/98
Ping Ada Chan, 5 Montie Ct, Glen Waverley	109.10	''	14/06/99
Elizabeth Jayne Hassett, 1093 Doncaster Road, Doncaster East	115.00	''	15/07/98
Angela Edwina Cameron, C/- Mrs Anne Cameron, 16 Myrtle Ave, Kew	111.85	''	08/02/99
Ms Wendy Rowles, 141 High Street, Mansfield	184.35	''	02/10/98
Safety Institute of Aust Inc., Federal Office, PO Box 93, Box Hill	105.95	''	04/06/99
Impac International Pty Ltd, 17 Anzeo Ct, Mulgrave	100.75	''	16/09/98
Samya Hanna, 10 Margaret Ct, Bundoora	204.59	''	25/05/99
Impac International Pty Ltd, 17 Anzeo Ct, Mulgrave	143.00	''	16/09/98
Impac International Pty Ltd, 17 Anzeo Ct, Mulgrave	138.25	''	''
Impac International Pty Ltd, 17 Anzeo Ct, Mulgrave	139.50	''	''
Impac International Pty Ltd, 17 Anzeo Ct, Mulgrave	139.00	''	''
Impac International Pty Ltd, 17 Anzeo Ct, Mulgrave	141.25	''	''
Adrienne Raie McGregor, 48B Napier St, South Melbourne	286.00	''	03/10/97
Miss Julie A. Bailey, PO Box 488, Cranbourne	230.00	''	18/08/97
D. M. Harrison, 125 Harris Street,, Corryong	130.00	''	31/03/99
Impac International Pty Ltd, 17 Anzeo Ct, Mulgrave	134.25	''	16/09/98
Source Services Pty Ltd, Level 3, 63 Stead Street, South Melbourne	124.05	''	24/06/99
Protective Finishes Pty Ltd, 50 Eastern Beach Road, Geelong	469.40	''	07/08/97
Plumbing Pty Ltd, PO Box 65, South Melbourne	135.00	''	24/05/96
Alan Wyatt Guest, PO Box 210, Oakleigh	155.55	''	17/11/98
Tery Owen Warin, Unit 2 19 Hammond Street,, Brighton	140.90	''	16/02/99
Tass Australia Pty Ltd, S.S. 77 Perrin Street, Robinvale	152.10	''	05/10/98
Francesco Crusca, 76 Teddington Rd, Hampton	103.55	''	02/02/99
Felicity Ann McGown, 30 Mcculloch Street, Dromana	100.00	''	10/06/97
W. E. Blight, 54 Powells Ave, Bendigo	100.00	''	15/04/98
Wayne Robert Appleby, 68 Reid Street, Hastings	290.35	''	08/11/96
Carol Mary McManus, C/o Flat 8, 757 Burwood Road, Hawthorn East	150.00	''	13/07/98
Siemin Hew, 4 Lomic Crt, Templestowe	123.90	''	02/07/98
Jon Christopher Mason, 2 Mason Ct, Highett	119.35	''	06/04/99
Timothy James Mitchell, 95 The Boulevard, Warrandyte North	242.25	''	03/11/97
Elwyn Elizabeth McGeachin, Hastings C/park Site 32, 249 High Street, Hastings	100.00	''	07/11/96
John Sposato, 24 Marcus Road, Dingley	116.10	''	09/12/98
Michael Hibbs, Mr, 49 Serpells Rd, Templestowe	140.63	''	08/07/98
Caroline Wilkins, 120 Grand Blv, Montmorency	150.00	''	23/10/98
John Fraser Bellhouse, 7 Bartlett Street, Moorabbin	113.50	''	29/10/98
Kathy Abbott, PO Box 150, Bundoora	190.70	''	29/12/98

Anna Elena Menece, 49 Nickson Street, Bundoora	100.00	''	07/08/97
Mrs Elayne Ta Vears, Fine Jewel, 41 Main St, Mornington	486.45	''	15/12/98
Richard Manning Anderson, C/- Post Office, Chewton	122.45	''	10/06/98
William Corner, 816 Esplanade, Mornington	100.00	''	05/08/98
Mrs C. G. Davis, Victoria Pde, Pearcedale	490.00	''	27/11/97
The Manager Bowring Engineering P/L, Cnr Warrigal & Cochranes Road, Moorabbin	122.65	''	07/06/99
Wendy Ogilvie, Process Service Australia, PO Box 377, Eltham	233.55	''	08/02/99
Intex Pacific Pty Ltd, 13 St Johns Pde, Kew	102.55	''	30/04/99
Janine Denise Chambers, C/- Ray Stone, Hattah Store Caulder Hwy, Hattah	103.50	''	12/03/99
Jetage Travel T/a Vicres, Shop 228, 270 Canterbury Road, Forest Hill	288.80	''	12/04/99
W. B. W. B. Hodgson, C/- G. James, Pre Debt, Attn Robert, Locked Bag 5655, Melbourne	601.64	''	01/04/99
G. Hay, 5 Salisbury Rd, Macedon	150.00	''	11/03/98
David Ian Cartwright, 13 Brolga Crs, Highton	102.15	''	09/04/99
Julian Egerton, 701 Station Street, Box Hill	1,210.58	''	25/08/97
Marion Jean Neil, Flat 2, 33 Francis Street, Belmont	140.65	''	14/04/99
Jock McWilliam, 71 Moscript Street, Campbells Creek	145.30	''	''
Joanne Lei, 1 Elm Ct, Templestowe	191.90	''	16/03/99
Valkstone Homes For Aged, The Secretary, 20-26 Manningtree Road, Hawthorn	181.87	''	22/05/99
Don Oyao, Unit 2, 52 Willsmere Rd, Kew	200.00	''	21/05/99
Drydox's Pty Ltd, T/a Global Video, 2 Florence Avenue, Berwick	233.90	''	18/03/99
Cherino Investment Pl, C/o Jones Lang Woolton, 530 Springvale Road, Glen Waverley	139.62	''	05/03/99
Dial A Flower Pty Ltd, Shop 1, 14 Walpole Street, Kew	460.00	''	11/11/96
Marshall White & Co Pty Ltd, Di Baker Real Estate, 150 Cotham Road, Kew	173.67	''	25/10/98
Dary Mik, Unit 1, 12 Boonah Street, Springvale	103.10	''	11/01/99
Ray Collodeti, 9 Allister Street, Fitzroy North	210.50	''	05/12/96
Hartpury House, The Manager, 9 Milton Street, Elwood	148.73	''	05/06/98
Robert Stanley Wootton, 15 Lincoln Street, Burwood East	210.85	''	17/11/98
Mark Anthony Harris, PO Box 104, Woodend	107.25	''	12/05/99
Joan Dorothy Preece, 21 High Street, Kangaroo Flat	145.30	''	29/10/98
Michael J. Barrington, 68 Peel Street, Kew	105.30	''	20/12/98
Gerard Pura, 7 Finch Pl, Blackburn	140.00	''	08/10/97
Kartrina Louise Sweeney, 138 Wilmington Ave, Hoppers Crossing	103.35	''	17/02/99
Frank Caruana, 36 Ireland Avenue, Doncaster East	199.60	''	20/01/98
Sally Forstner, 9 Railway Pde, Murrumbeena	112.65	''	26/05/98
Gavin Jensen, 295 Canterbury Road, Ringwood	108.25	''	23/12/98
Marie Millers, 5 Westlands Road, Glen Waverley	131.75	''	29/09/97
Damien Travanio, 539 High Street Rd, Mt Waverley	106.90	''	02/11/98
William Sutton, PO Box 29, Manangatang	129.85	''	10/11/98
Brian Raymond Riley, 23 Sydenham Ave, Bendigo North	146.90	''	04/02/98
Ron & J. Smith Nominees Pty Ltd, 417 Blackburn Road, Mount Waverley	188.25	''	17/05/99
Terrence Piper, 7 Kildare Street, Hawthorn	254.85	''	27/10/98
Christopher Mark Ralph, 10 Westgarth St, Malvern East	191.75	''	16/03/98

Deans Ross Neville, 33 Highmont Drv, Belmont	102.95	''	30/11/98
Maree Vernon, PO Box 5007, Wonga Park	177.95	''	26/09/97
Brendan John Hefford, PO Box 493, Belmont	249.85	''	21/05/98
Heidi Jane Thorton, 188 Hargreaves Rd, Strathfieldsaye	120.50	''	18/05/98
Samantha Jane Comte, Unit 4, 33 Stawell Street, Kew	110.22	''	12/01/99
Glen Stuart Morrison, 1 Rimington Ave, Kew	101.34	''	26/05/98
Grallo Pty Ltd, 26 Victoria Street, Eaglehawk	128.45	''	28/09/98
Long Zhang, 201 Gower Street, Preston	107.85	''	12/02/99
Geoffery Alan Stops--, 23 Thornton Street, Kew	112.60	''	01/03/99
Brian Lancel Hyatt, 14 Duffy Street, Woodend	100.95	''	17/02/98
Tom Kalagurgevic, 15 Avonlea Rd, Bell Post Hill	209.85	''	19/05/99
Susu Nousala 14 Park Street, Trentham	117.40	''	14/09/98
L. Johnston, 7 Villamanta Street, Geelong West	173.35	''	29/08/97
Olga Drakopoulos, 66 Axford Street, Oakleigh South	852.75	''	26/05/98
Edith Sita Barrow, 22 Monash Ave, Balwyn	100.00	''	22/05/98
Yutu Pty Ltd, 16A Coleridge Street, Kew	147.05	''	07/08/97
Leo Treble, PO Box 1333, Kangaroo Flat	185.95	''	27/01/99
Carmen Ines Roman, Unit 9, 69 Spring Rd, Springvale South	101.60	''	22/07/98
Fiona Counsel, T/a Fashion Counsel, PO Box 90, Armadale North	244.70	''	12/10/98
Van Vu Truong, Flat 3, 488 Springvale Rd, Springvale	132.65	''	12/05/99
Nabil Meleka, 44 Stephenson's Rd, Mt Waverley	114.85	''	11/05/99
Australian Die Castings, Cook Road, Mitcham	1,767.15	''	06/11/98
Mr J. Thomaras, 41 Fitzroy Street, Geelong	121.15	''	28/04/99
Caryn James, Flat 2, 33 Grove Road, Hawthorn	100.00	''	26/08/98
Norma May Richards, 25 Austin Street, Balwyn	107.60	''	09/04/99
Mr R. K. Lawrence, 14 Yarra Street, Kew	135.90	''	15/03/99
The Delicious Noodle Company Pty Ltd, 9 Cope Court, Wheelers Hill	104.05	''	19/01/99
Thelma Hickey, C/o Rmb 770, Trentham East	234.57	''	01/04/99
Anne Symonds, 6 Vega Cl, Noble Park	250.00	''	06/11/98
Mr Graeme Albert Wood, 120 Thompson St, Hamilton	219.50	''	12/05/99
Action Fire Service Pty Ltd, 159 Barclay Ave, Richmond	433.60	''	11/05/98
Bladen Gibson Pty Ltd, Suite 2B, 68 Oxford Street, Collingwood	137.37	''	04/09/98
Ingrid Susanne Hodgson, 101 Stevenson Street, Kew	103.20	''	27/01/99
Irene Guest, 32 Flinders Street, Sunbury	124.50	''	07/08/97
Mr Otto Humar T/a Otto's Meats, Flat 4, 427 Blackburn Rd, Mt Waverley	119.90	''	26/01/99
Arnold Crest Pty Ltd, Re Dept of Treasury & Finance, Level 14/2 Lonsdale Street, Melbourne	140.32	''	28/11/98
Leanne Rowlands, 22 Montrose Street, Ashwood	150.00	''	09/12/98
Marcus Ashley Tamblyn, Fosterville Road, Huntly	130.95	''	18/11/97
Karen Fister, T/a Natural Image Trading, 40 Campbell Road, Balwyn	113.90	''	26/05/99
Loris Doreen Casar, 29 Ferrier Street, Mt Macedon	145.00	''	18/12/98
Kym Leeanne Moore, 13 Hamilton Rd, Riddells Creek	185.00	''	14/11/97
Furniture Service Bureau P:L, 217 Bulleen Rd, Bulleen	117.50	''	08/01/99
Dennis Charles, Shop 1, 301 High St, Kangaroo Flat	234.00	''	12/03/99
Suzanah Frank, 11 Landen Ave, Balwyn North	110.50	''	21/05/99
Stowford Pty Ltd, The Manager, 215 Lt Collins Street, Melbourne	686.72	''	23/02/99

HVJ Services, Locked Bag 14090, Melbourne City Mail Centre, Melbourne	177.49	''	05/06/98
Darren Hargreaves, Unit 1/524 Tooronga Rd, Hawthorn East	242.45	''	30/06/99
Deborah Elizabeth Pelling, 16 Macs Street, Peterborough	259.85	''	11/09/97
Elna Press, Fire Alarm Account, PO Box 201, Cheltenham	117.52	''	12/08/98
Leanne Doncastor, RMB 5595 Inglis La, Mirboo North	138.95	''	24/04/98
Microtech Security Control P/L, T/a Fai Home Security, 6/422 Collins St, Melbourne	602.95	''	15/05/97
Bernadet Matheo, 22 Hastings Crs, Broadmeadows	196.80	''	18/03/99
Brian Raymond Hartney, 6 Cowper Street, Bendigo	121.65	''	18/09/97
Dura Aust Constructions Pty Ltd, GPO Box 1130CSNDC, Clayton South	232.45	''	10/03/99
Anton Kezerle, 83 Erinbank Crs, Westmeadows	157.65	''	04/12/98
Ronald Dean Besley, Unit 1, 15 Tennyson St, Elwood	110.65	''	09/11/98
Dora Jakobovic, 49 Orrong Cres, Caulfield North	207.14	''	12/09/97
Rodger Hearnden, 15 Carlisle Street, St Kilda	175.05	''	19/02/97
Reginald Charles Lawrence, 69 Korumburra–Warragul Road, Warragul	109.00	''	23/10/97
Annaliza Saplab Arzo, 31 McIver Street, Ferntree Gully Upper	150.00	''	07/08/97
Bapu Boppana, Unit 12, 12 May Street, Elwood	222.45	''	02/09/98
Nasah Management Services Pty Ltd, 239 Koornang Road, Carnegie	116.05	''	30/11/98
Ahmad Avouhasana, 85 McIntosh Road, Altona North	114.25	''	03/06/99
Douglas Reeves, 10 Rosamond Crs, Doncaster	260.20	''	10/03/98
Brenda Jackman, 137 Gladstone Street, Bendigo	110.00	''	20/11/98
Camperdown Courier Service Pty, 8 Pike St, Camperdown	250.27	''	03/11/98
Matthew McCormick, Unit 2 6a Victoria St, Bendigo	148.65	''	22/07/98
Dean Liaskos, 465 High Street Rd, Mt Waverley	200.00	''	28/03/96
Anthony John Brushfield, 18 Larcombe St, Highton	100.50	''	01/10/96
Kenneth Morris Barnett, 62 Magnolia Crt, Templestowe Lower	405.60	''	18/02/98
Shiatsu Australia Pty Ltd, PO Box 2064, St Kilda West	144.20	''	22/06/99
I. Comici Theatre Company, PO Box Hurstbridge	125.25	''	31/03/98
Juhee Ahmed, Unit 5, 14 Hennessy Ave, Elwood	162.35	''	22/07/97
Nick Giannikakis, 2 Raleigh Street, Malvern	169.85	''	09/04/97
S. Koc, 3 Cannt Crt, Broadmeadows	345.60	''	30/12/97
Veronica Orsini, 14 Dromana Pde, Dromana	100.00	''	15/07/98
N. W. G. Holdings P/L, Unit 22/107–113 Heatherdale Rd, Ringwood	111.75	''	30/07/98
Debra Jayne Kwasnicki, 147 Gordon St, Balwyn	117.30	''	19/08/97
W. K Nicho Ng Service Mentone, 154 Charman Road, Mentone	122.19	''	20/10/97
Elanie Rieger, Flat 6 42 Ruskin Street, Elwood	142.70	''	01/05/99
New Generation Lasers, Mr Jo, T/a New Generation Lasers P/L, Suite 4, 582 St Kilda Rd, Melbourne	230.07	''	07/08/97
Laser Tecs Pty Ltd, PO Box 359, Deepdene	475.34	''	09/12/98
Anthony Pavlou, T/a Thunderbolt Tackle, 8 Foster Street, St Kilda	197.50	''	27/11/97
A. Moore, 9 Glenallan Street, Broadmeadows	125.15	''	28/04/99
Camperdown Courier Service Pty Ltd, 8 Pike Street, Camperdown	128.54	''	17/11/98

Stephen Nicholson Bolsin, 26 Stephen Street, Newtown	441.80	''	22/01/99
Walters Kenneth George, PO Box 1238, Horsham	104.15	''	17/05/99
Wayne Bradley Hoffmann, 310 St Kilda St, Brighton	144.90	''	12/03/99
Rex John Saywell, Unit 2, 10 Larkspur Ave, Doncaster	340.70	''	15/12/98
Lodmore Pty Ltd, 7 Janine Crt, Newcomb	186.60	''	18/12/98
Mrs Maryellen O'Malle, 522 Thompson Rd, Norlane	308.50	''	30/12/98
Donald Smith, 4 Need Ct, Warragul	412.65	''	31/05/99
Christine Sheahan, 6 Dalton Street, Myers Flat	121.30	''	07/06/99
Abigail Font, 1363 Burwood Hwy, Ferntree Gully Upper	140.00	''	08/12/97
Craig Raymond O'Neil, 49 Energetic St, Long Gully	173.75	''	03/02/99
Wendy Patricia Schwab, 45 Crimea St, St Kilda	147.95	''	26/11/98
Barry J. Keam, PO Box 3, Essendon North	111.24	''	11/06/99
David Andrew Hodson, 103 Torbay St, Macleod	102.25	''	10/03/99
Angela Curcio, Unit 1, 39 Jeffrey Ave, Bendigo	140.00	''	02/02/99
Sheue-Lee Ooi, 25 Boronia Street, Canterbury	128.25	''	15/06/99
Paul Sillon, 4/43 Ackland Street, St Kilda	136.70	''	08/10/98
Kim Edmonds, 23 Bales Street, Ferntree Gully	105.20	''	04/01/99
T. J. Frew, Apt 4 3 Ardoch Ave, St Kilda East	237.30	''	09/03/99
Mr Clint Smith, WP Billing Poppy, Locked Bag 4000, Collingwood	135.00	''	27/01/98
Stephen Pyrros, 19 Harbury Street, Reservoir	121.23	''	16/01/99
J. R. Binks, 15 Mount View Rd, Upper Ferntree Gully	100.00	''	02/10/97
Michael Breheny, 19 Heathfield Rd, Brighton East	119.45	''	03/11/97
June T. Housden, 53 Cecil Street, Kew	123.20	''	06/04/99
Jancie Mary Cook, Lot 18 Eagle Drv, Eaglehawk	100.00	''	01/12/98
Zvi Kessler, 13 Moorookyle Avenue, Oakleigh	182.10	''	25/05/98
Boxshall, Max, 28 Albert Street, Warragul	126.02	''	''
Computer Packages Pty Ltd, Ground Floor, 682 Doncaster Rd, Doncaster	102.81	''	09/09/98
Mathew Joseph Devine, Baillieu Road C/o Torrumbarry Post Office, Torrumbarry	102.25	''	16/04/97
Mr Danny O'Dea, C/- Kerry Reynolds, PO Box 229, Ballarat	295.95	''	20/10/98
John Op-De-Laak, 87 Chomley Street, Prahan	133.25	''	18/07/97
Carmen L. Hammond, T/a Bloomfield Plants, Cnr Smith & Palmerston Street, Warragul	128.85	''	18/06/99
Lily Choa, Unit 2, 13 Dehnert St, Doncaster East	563.79	''	28/07/98
John Douglas, 135a Martin Street, Gardenvale	108.50	''	06/10/98
Yahya Akan, 2 Elva Court, Mitcham	113.50	''	30/04/99
Neville Smith, PO Box 2160, Mt Waverley	193.40	''	28/05/97
Jeniffer Stoll, 35 Cleveland Road, Ashwood	200.00	''	13/09/96
The Bicycle Corporation, 9 Villa Road, Springvale	206.15	''	30/07/97
Alyssa Bagley, 31 Fulcher Street, Daylesford	122.55	''	23/04/99
Martin Bernard Harrington, (Sole Trader), 1 Bambara Cl, Bendigo	111.70	''	04/05/99
Lincoln Harris, 21 Hexam Street, Warranwood	156.55	''	27/11/98
Luke Stow, Unit 2/84 Belmore Rd, Balwyn	136.29	''	06/03/99
Trieu Pham, Unit 5/12 Malcolm Crt, Kealba	348.20	''	12/11/98
Mr Kong Chao, 141 Main Street, Lilydale	179.00	''	14/04/98
Mr R. J. Jolly, 899-903 Plenty Rd, Kingsbury	330.90	''	12/10/98
Barbara Hermon, Unit 1, 10 Hosie St, Richmond	220.05	''	13/10/98
Gary Burns, T/ ;Leongatha Flower Power, 9 Lyon Street, Leongatha	141.45	''	17/03/99

Dessco Pty Ltd, 32 Fawkner Road, Pascoe Vale	378.85	''	29/04/99
Mr J. W. Schoots, 30 Booloora Road, Springvale	143.95	''	22/09/97
Lynette McArthur, 4 Misbett Street, Reservoir	223.85	''	02/12/98
Kathryn Lorraine Dugonjic, 8 Louis Street, Airport West	296.20	''	04/07/97
Speeds Shoes Monleigh Pty, Shop 24, Plaza Shopping Centre, Taylors Rd, Keilor Downs	502.35	''	16/04/99
Sleepeeze Bedding P/L, 29 Jessica Rd, Campbellfield	1,628.10	''	06/10/98
Profile Design & Construct P/L, PO Box 272, Tullamarine	215.65	''	15/10/98
Christine Jane Sinclair, 7 Eccles Rd, Ocean Grove	189.25	''	23/10/98
Rita Marie Thomas, 1 Elva Road, Ocean Grove	262.30	''	23/11/98
Mr Peter Jovanovski, Shop 8, Keilor-Melton Road, Taylors Lakes	101.80	''	''
The Tyre Connection, Ms Ela, T/a The Tyre Connection, 204 McIntyre Rd, Sunshine	150.00	''	22/01/99
Palm Idol Pty Ltd, Rent-A-Car Pty Ltd, 15 York Street, Drumcondra	294.35	''	27/08/97
Dr Mark Umstead, Suite B, Level 10, F.P.H. 285 Cardigan Street, Carlton	108.18	''	24/02/99
Pathtech Diagnostics Pty Ltd, PO Box 175, Balwyn	292.60	''	03/09/97
Frances Venus Leonboier, 56 Macrina St, Oakleigh East	148.00	''	18/06/97
Timothy David O'Callaghan, K & T Builders, 4 Eureka Street, Geelong West	154.55	''	24/02/99
Annie Hirst, Unit 2, 16 Stewart St, Williamstown	100.00	''	29/09/98
Cooper David, 1 Sommerville Street, Bendigo	290.35	''	20/07/98
Lee Maree Dimartino, 2 Nerida Crt, Taylors Lakes	137.20	''	07/08/97
MacKieson T/a Morecroft Shoes, 325 Main St, Lilydale	107.95	''	11/02/99
Jardine Matheson (Australia) Ltd, 1/660 Doncaster Road, Doncaster	1,304.41	''	01/10/98
Your World Travel Pty Ltd, 107 The Esplanade, Crib Point	321.00	''	05/02/99
Sylvia Cufari, PO Box 896, Red Cliffs	156.90	''	25/11/98
David Wood Auto Repairs Pty Ltd, Factory 3, 98 Canterbury Rd, Bayswater North	123.80	''	19/10/98
Christine Dorethy Cameron, 585 King St, Melbourne	105.75	''	13/11/98
George Paganis, 423A Monbulk-Silvern Rd, Monbulk	115.70	''	18/11/98
Crean And Company Pty Ltd, Mulgrave Court, Unit 22, 35 Garden Rd, Mulgrave	376.50	''	08/01/99
Richmond Chamber of Commerce, 94 Bridge Rd, Richmond	243.30	''	12/09/97
Guy Murphy, 35 Parkville Street, Burnley	140.35	''	18/03/99
Vittorio Salterni, C/- Sue Barratt, Locked Bag 10, Ivanhoe	173.00	''	06/01/98
Mong Thu Tren, 60 Wardale Road, Springvale	125.30	''	12/10/98
Airineers Pty Ltd, 13 Boundary Road, Harkaway	227.45	''	04/05/99
Andrew Weeks, PO Box 284, East Melbourne	123.30	''	29/09/97
Derrick Simmons, 41 Penser Street, Preston	144.35	''	31/03/99
Health Solutions Pty Ltd, PO Box 419, Carlton South	191.92	''	20/07/96
M. W. Jones, 126 Buckley Street, Noble Park	124.35	''	25/09/96
Andrea Mayer, 3 View Street, Alphington	221.35	''	15/05/98
Eaglework Tyre Service Pty Ltd, Factory 2, 4 Wood Street, Bendigo	234.80	''	01/02/99
Community Services & Health, PO Box 608 A'Beckett Street PO, Melbourne	321.43	''	06/11/98
John Szweide, 85 Victoria Street, Williamstown	147.40	''	27/05/98
Lisa Burchell, Flat 4, 310 Albert Street, Sebastopol	163.00	''	18/06/99

Stephen Fox, Unit 205, 106 Elizabeth Street, Richmond	102.15	''	25/05/99
B. Le, Flat 180, 110 Elizabeth Street, Richmond	327.25	''	27/05/99
Richard Damien Evans, Unit 1, 19 Monash Street, Oakleigh South	340.00	''	24/11/98
Steven Spangher, C/- Graham Jones, 396 Little Bourke Street, Melbourne	111.20	''	16/03/99
Nicolas Andrew Cox, 82 Chestnut St, Richmond	102.10	''	04/02/99
Kiera Lockyer, 15 Sixth Street, Hepburn Springs	114.80	''	03/05/99
E. S. Winter, 21 Noble Street, Barwon Heads	240.00	''	08/12/98
Wallace Lloyd Fraser, "Moorallah" RMB 371, Skipton	129.80	''	26/08/98
Augustus Roy Ward, C/o Mrs O. Green, Block 8A, Macauley Road, Myrtleford	251.36	''	13/05/97
Krishna Suparka, Unit 1, 105 Torbay Street, Macleod	170.00	''	07/04/98
Fiseha Wosero Segal, Flat 11, 37 Somerville Rd, Yarraville	269.70	''	29/03/99
Albert Johnston, C/o State Trustees, Ref 270265, GPO Box 1461N, Melbourne	121.33	''	18/01/99
Keith Lawrence Baillie, Unit 55, 88 Wells Street, South Melbourne	259.15	''	03/03/97
Norma Jean Kerrison, 62 Grandridge Rd, Mirboo North	100.00	''	09/04/99
Christofolos Xenitellis, 42 Birmingham Rd, Mt Evelyn	118.50	''	19/01/98
Alicia Gleeson, Flat 10 201 Gold Street, Clifton Hill	212.55	''	23/11/98
Manocher Mehrkhavari, T/a Opal Male Fashion, 227 Bridge Road, Richmond	158.20	''	05/05/99
Supadeal Furniture Pty Ltd, Sunshine Plaza, Shop 39, Cnr Hampshire & Service Streets, Sunshine	446.95	''	08/09/98
Louise Barbara Di Natale, 22 Grosvenor Street, Brighton	112.85	''	19/08/97
Joy Valerie Wilson, Shanley St, Wangaratta South	141.90	''	05/10/98
David Couacaud, 7 Garie Ct, Grovedale	129.90	''	26/05/99
Jennifer Anne Gale, PO Box 4003, Market Place, Bendigo	135.65	''	14/05/99
Vince Tuttobene (Sole Trader), 53 Bridge Rd, Richmond	135.25	''	09/03/99
Leanne Christina Lockyer, PO Box 650, Echuca	200.00	''	20/11/97
Jobs East Pty Ltd, (Blakes Function Centre) 333 Mitcham Road, Mitcham	113.73	''	10/10/98
Bruce Frederick Tanner, 12 Keogh Dr, Spring Gully	120.45	''	05/11/97
Swan St Auction, 365 Swan Street, Richmond	135.34	''	07/05/99
Jennifer Maureen Jones, 3 Gala Pl, Keilor Downs	120.00	''	24/06/98
Intergraph Corporation Pty Ltd, Level 4, 420 St Kilda Road, Melbourne	1,227.54	''	19/08/98
Steelline Doors Pty Ltd, 104 Horne St, Campbellfield	149.53	''	11/09/98
I. S. Hamilton, 2 Lawson Street, Balwyn North	229.60	''	23/03/98
Brian Busuttil, Unit 2, 23 Garfield St, St Albans	184.30	''	05/08/98
Nicole Murphy, 62 Wingarra Drv, Grovedale	140.05	''	14/01/99
Ophelia Whiteman, Unit 14, 10 Drechsler St, Bendigo	329.85	''	07/05/97
Sleepeeze Bedding Aust Pty Ltd, 29 Jessica Road, Campbellfield	186.58	''	10/09/98
Nicole Ellis, 1235 Pascoe Vale Rd, Broadmeadows	129.00	''	30/12/98
DA Information Services, 648 Whitehorse Rd, Mitcham	118.40	''	23/03/93
Morag Miller, T/a The Deli, 164 Rathdowne St, Carlton	129.95	''	23/02/99
Grant Thornton, Admin for Tunsta Insolvencies, PO Box 434, South Yarra	576.51	''	09/11/96
Pamela Ida Allan, Sails Cafe, PO Box 127, Lorne	130.95	''	28/05/98
Richard Morton, 457 Ballarat Rd, Sunshine	100.00	''	22/07/97

Wolfgang Richter, T/a Ken Hallam Automotive, 21 Inverlocky Street, Anglesea	106.00	''	24/06/99
Mr John Omeara, 37 Vincent Street, Daylesford	122.45	''	25/03/99
Elizabeth Braddock, 17 Lynch Street, Sunshine	125.00	''	15/05/98
Mahmoud Soussi, Unit 1, 19 Edinborough St, Hallam	200.00	''	20/10/97
Mary Galea, 3/8 Parker Street, Werribee	150.00	''	12/08/98
Paul Anderson (Sole Trader), 49 Hope St, Springvale	136.15	''	12/09/98
R. Storey, 10 Henry Street, Noble Park	150.00	''	06/01/99
Robert John Fraser, 62 Wilma Ave, Mulgrave	100.00	''	03/03/99
Tsengue Jongue, 4 Bilbungra Drv, Keysborough	194.60	''	29/01/99
Peter Bestenbreur, T/a Current Industries, Factory 1, 20 Rimfire Drive, Hallam	197.30	''	19/11/98
D. H. Keble-Johnston, 72 Wattletree Rd, Malvern	149.85	''	11/06/97
Ovfanna Sarian, 20 Walter Street, Noble Park	138.60	''	09/12/98
MacKenzie Sanderson, 16 David Street, Carlton	349.11	''	30/10/98
A. J. Ball, 19 Lentara Cres, Werribee	100.00	''	06/03/98
Ms Lyn Jones, T/a Kelly's Cookhouse, 40 Gladstone Street, Glenrowan	127.55	''	16/06/99
Zane Paul Martin, 25 Naranghi Dr, Bendigo	101.60	''	19/03/99
Scott Andrew Hardiman, Complete Cable, 53 Stagecoach Cres, Sydenham	103.25	''	18/05/99
Tanya Marie Atta'singh, Lot 3, Albert Street, Lorne	128.52	''	16/04/98
Lucky Tahir Pty Ltd, PO Box 277, Melton	115.25	''	23/03/99
Lempriere Aust P/L, 24 Douglas Street, Toorak	100.35	''	07/06/99
Peter Anderson, T/a Daylesford Pharmacy, 39 Vincent Street, Daylesford	174.25	''	20/10/98
Haydn James Mathers, RSD 581, Emu Creek Rd, Strathfieldsaye	100.00	''	25/09/97
Anita Cardillo, Unit 35, 26 Victoria Street, Fitzroy	158.30	''	17/03/98
Elizabeth Margaret Daly, 8 Uvadale Grv, Kew	173.30	''	25/08/97
Maryanne Heading, 383 Latrobe Street, Melbourne	135.40	''	26/05/99
Maureen Elizabeth Jongsma, 5 Fourth Ave, Aspendale	182.00	''	16/12/97
Hamish MacKeller, Unit 6, 23 Grattan St, Hawthorn	102.55	''	21/05/99
Dennis Charles Meehan, 12 Banksia Ave, Beaumaris	144.60	''	13/03/99
David John Poulton, 2 Panorama Drv, Delacombe	132.65	''	14/04/97
Catherine Louise Stewart, 75 Railway Cres, Williamstown	112.35	''	21/10/98
Jana Christine Robinson, Lockington West Rd, Lockington	101.50	''	14/05/97
Desmond Younge, 33 Reynard Street, Coburg	161.00	''	23/02/98
Adam Mifsud, 9 Mcnae Street, Moonee Ponds	140.75	''	07/08/97
Maranda Villafiora, Unit 2, 57 Alma Ave, Altona Meadows	108.55	''	17/03/99
Australian Natives Assoc, 8 Sturt Street, Ballarat	563.05	''	01/03/93
Carol Reid, 3 Copley Crs, Laverton	100.00	''	19/08/98
Power Machinery Pty Ltd, PO Box 95, South Melbourne	175.55	''	10/06/99
Tracy Dawn Dewhirst, 20 Oaklands Cres, Frankston	105.90	''	12/02/99
Jay Sadhai, 25 Border Drive Keilor East	257.00	''	25/06/99
Daniel Robert Hunt, 45 Derbyshire Street, Sunbury	100.00	''	08/10/97
Yvonne Evans, 19 Loch Street, Hawthorn East	104.79	''	13/03/98
Lavina Melveen Pappas, 69 Murphy Rd, Pakenham	100.00	''	22/03/99
Rebecca Newell, Unit 2, 36 Donald Street, Laverton	109.65	''	26/07/96
Ryan Tillage Equipment Pty Ltd, Admin Acct (Final), Box 2266U GPO Melbourne	208.36	''	21/01/98
Dellavedova, Colin, PO Box 157, Maryborough	310.55	''	23/09/97
James Gerard Hogan, 18 Bogart Drv, Wendouree	103.95	''	17/11/98

Natalie Jean Leighton, 30 Lindrum Rd, Frankston	111.05	''	08/05/99
Lau Jack, 129 Main Street, Bacchus Marsh	126.97	''	07/04/98
Peter J. Jenner, 36 Parkwood Drv, Traralgon	113.00	''	15/02/99
Jones Stroud (Australia) P/L, 108 Dandenong Rd, Frankston	105.29	''	16/04/99
Mr N. C. Mott, PO Box 9, Lascelles	333.40	''	27/04/99
Ulrich Labels Australia, 9-11 Kerr Street, Preston	141.40	''	05/11/97
Dench Bros Pty Ltd, PO Box 700, Rosanna	133.70	''	25/05/99
Pippa Anne Hippisley, 5 Lambert Street, Richmond	136.17	''	17/12/98
Steve Conrad Malleen, 28 Stephenson Road, Seaford	1,004.87	''	26/09/97
Shaliza Shukor, Unit 1 32 Burke Rd, Malvern East	120.00	''	03/10/96
John Michael Margetts, 31 Elm Gr, Kew East	160.15	''	10/02/98
Peter Noel Bluck, 39 Nightingale Ave, Wodonga	140.15	''	07/12/98
Michael Frederick Field, 2 Neave Street, Hawthorn	238.65	''	25/01/99
JC Ventures & Concepts Pty Ltd, 31 Cameron Street, Brunswick	159.80	''	24/02/98
Richard Grahame Allen, 17 Acacia Ave, Blackburn	103.55	''	20/01/99
Professional Dental Supplies, Factory 3, 8 Nicole Cl, Bayswater North	122.10	''	01/12/98
Amanda Keep, Unit 2, 1 Beach Rd, Elwood	150.00	''	18/12/98
Bernard Kasjan, 17 Orrong Rd, Elsternwick	103.28	''	13/05/99
Harold William Bicknell, 3 Mirang Ct, Frankston	143.55	''	23/11/98
Mitrovski Blagoja, 15 Bridget Crt, St Albans	150.00	''	25/02/98
Elizabeth Burgmann, 24 Rolland Street, Coburg	260.00	''	07/08/98
Mediha Cikikci, 4 Hall Street, Coburg	123.35	''	07/01/98
James Teodor Kwiatkowski, 12 Delaware Crt, Hoppers Crossing	147.00	''	10/12/98
Tracey Reed, 52 Smethurst Ave, Pakenham	100.00	''	20/01/99
Sec of Victoria, Res of Mr Creighton, Vickery St, Alexandra	161.10	''	20/11/98
Bernadette Eileen Napoli, 6 Elean Court, Hillside	171.35	''	22/06/99
Raniere Tom (Mr), T/a: Starway Warrandyte, 2 Poppys Court, Warrandyte	337.00	''	18/10/98
John Moyes, C/o Hocking Stuart Real Estate, 312 Melbourne Road, Newport	118.75	''	31/03/99
Dilosa Maria Grillo Angelo, 241 Bambra Rd, Caulfield South	299.52	''	16/12/98
Carman Frances Trimble, 29 Houqua Place, Cranbourne	117.30	''	18/06/99
Embark Training Incorporated, 319 Glenhuntly Road, Elsternwick	147.13	''	16/07/98
Thomas Joseph Sweeney, 9 Melton Ave, Carnegie	142.00	''	26/10/98
Mountain Views Newspapers P/L, Co Brooke Bird & Co, PO Box 328, Balwyn	151.49	''	30/07/96
Concept Sports, 205 Clarendon St, South Melbourne	120.00	''	25/03/99
Yaron Schwalb, 236 262 East Boundary Rd, Bentleigh East	153.50	''	07/01/98
Michael Valexander Clements, 233 Union Street, Brunswick West	105.80	''	21/04/99
Ilona Waldron, Delabra 32 Clinton St, Brighton East	141.65	''	18/12/97
Elio Sciaraffa, 31 Westgate Way, Keilor East	106.95	''	22/02/99
J. & B. Waste Services Pty Ltd, PO Box 202, Bacchus Marsh	119.20	''	15/02/99
Max Tauti, 8 Mereweather Ave, Frankston	100.00	''	28/04/97
Cook & Cook Travel, Ian Gr, 7 A Wells St, Frankston	142.80	''	23/02/99
Rodney William George Renzella, 15 Tantani Street, Frankston North	100.00	''	31/07/98
Douglas Huett, 19 Culcairn Drv, Frankston	180.00	''	04/02/98

T. V. Cole, 1 Rennison Street, Beaumaris	180.03	''	06/02/98
Guillerma Nancarrow, Unit 8, 11 Bishop St, West Footscray	124.95	''	31/05/99
Anne Marie Talia Isaac, 9 Dunk Crt, Hoppers Crossing	231.30	''	16/09/97
Alan Griffin Services Group, (A.Griffin), 4 Treasury Place, Melbourne	231.70	''	18/12/98
Pauline Powell, Unit 2, 10 Loch Street, Cranbourne	100.00	''	17/09/98
Mark Sekic, 10 Delmont Crt, Endeavour Hills	207.70	''	24/01/99
Erica Yan-Yee Tran, Unit 5, 90 Roseberry St, Ascot Vale	166.48	''	10/07/97
Chris Duffy, PO Box 1512, Black Rock	125.35	''	29/03/99
Barry Gregory Fox, PO Box 154, Laverton	414.45	''	20/10/98
James Neff, C/o Schlumberger Old Field Aus, Level 4, 150 Albert Road, South Melbourne	444.81	''	07/04/98
Hazel Bayliss, 7 Marks Crt, Harkaway	159.00	''	20/05/99
Anthony Gouzamanis, 7 Belgrave Street, Coburg	130.05	''	13/10/98
Pia Carter, 2 Kars Street, Frankston	100.00	''	25/06/96
Seniha Mustafa, 16 Nareen Ave, Endeavour Hills	163.10	''	26/03/99
Nela Kukucka, 77 Shane Ave, Laverton	165.05	''	12/11/98
Leonie Schweitzer, 14 Ardoch Street, Essendon	139.05	''	18/06/99
Kevin David Hamence, 10 Woodlee Street, Dandenong	114.40	''	14/01/99
Jeannette Frances Burgess, Flat 4/9 Charles St, St Kilda	170.00	''	31/05/99
Alexiou,Riz & Co., 278 Union Rd, Moonee Ponds	103.50	''	03/06/99
Raymond Gerard, 15 Edward Cres, Wendouree	835.26	''	28/06/99
Stephen Michetti, RSD R836 11, Grenville	309.20	''	25/05/99
Kevin Ronald Waters, 24 Aitken St, Alexandra	320.40	''	19/06/97
Lanier Australia Pty Ltd, 854 Lorimer St, Port Melbourne	183.30	''	11/06/99
Healesville Shire Council, 7 George Rd, Healesville	119.55	''	30/06/99
Terrance Patrick Ryan, RMB 9315, Garvoc	777.76	''	29/10/97
Richard Bonn, 4 Eckford Street, Dandenong	113.40	''	22/12/98
Naomi Kape Cuthbert, 54 Olympus Drive, Templestowe Lower	110.53	''	23/09/98
Justin Lucas, 18 Wallace Grv, Brighton	294.80	''	24/06/99
Leo Peter Driessen, PO Box 5025, Wonga Park	107.85	''	20/01/99
Joseph Cauchi, PO Box 255, Mount Evelyn	119.70	''	05/06/99
Rans Management Group Pty Ltd, 9999-99999 Moira Av, Carnegie	128.50	''	10/05/99
Samantha Jo Sterling, 188 Hawthorn Rd, Vermont South	103.50	''	27/10/98
Carol Wilson, 84 Glencairn Ave, Brighton East	111.00	''	27/01/99
Briya Munasinghe, 28 Blossom Park Drv, Mill Park	152.60	''	02/03/99
Louise Paki, 1073 High Street, Reservoir	246.90	''	16/10/97
George Footit, 5A Torresdale Rd, Toorak	658.55	''	28/09/98
Diggers Take Away, Mr Toufi, 22 Cradle Rd, Diggers Rest	133.85	''	19/04/99
Mr D. J. Drew, Lot 5, St Johns Rd, Wonga Park	103.85	''	19/01/99
Wayne Keogh, PO Box 5156, Clayton	124.35	''	10/05/99
Mr V. Barrant, 1 Tucks Rd, Main Ridge	174.40	''	21/04/99
Mary Jane Ciorcalo, 127 Ninth Ave, Rosebud	125.00	''	28/11/96
Eric Warren Enterprises Pty Ltd, PO Box 180, Preston	228.35	''	09/12/98
Bruno Gusts, 21 Brisbane Road, Cockatoo	278.64	''	24/06/97
Ronald Morel, 7 Faulkner Street, Hampton	122.85	''	11/11/96
Mescal Anne Melthropp, 9 William Street, Emerald	166.40	''	07/01/99
Mr Eric Ian Smith, 96 Riddell Rd, Sunbury	107.00	''	28/10/97
Alfred Richard O'Sullivan, 8 Rendall Crt, Hughesdale	180.00	''	18/03/98
Peter Sylvester Vanriel, 1 St Andrews Crt, Black Rock	267.41	''	21/07/97
Alan Wayne Laidler, 33 Dandenong Street, Dandenong	171.45	''	09/04/99

Thomas Ronald Armstrong, 146a High St, Cranbourne	174.40	''	30/10/97
Michael Burstin, 77 Mathoura Road, Toorak	141.15	''	10/06/97
Pamela Gunn, 87 Frankston-Flinders Rd, Shoreham	100.05	''	26/04/99
J. S. Masters, PO Box 73, Wandin North	149.45	''	08/07/97
Rhonda Denise Collins-Earle, 122 Albert St, Preston	105.10	''	28/04/99
Nerida Townley, Willowbank, 18-24 Seychelles Road, Shoreham	339.88	''	11/12/98
Joanne Alice Felmingham, 16 Olive Rd, Doveton	335.00	''	24/10/96
S. Dejong, 8 Helston Crt, Croydon	263.00	''	21/05/98
Daryl Kennedy, 47 Highbury Grv, Prahran East	100.35	''	23/07/97
Debrah Jamieson, 70 Mollison St, Dandenong	108.00	''	07/08/96
Ms M. Smith, T/a Mareli's Cafe, PO Box 109, Red Hill South	111.00	''	29/09/98
Joanne Basri, Unit 2, 18 Tennyson Street, Brighton	1,585.59	''	23/08/98
Kerry Macklin, 29 Emerald Street, Preston	125.85	''	22/10/98
Mr H. D. Rose, Henderson Rd, Seville	128.85	''	04/03/99
Debra Kunze, RMB 1485, Nullawarre	100.00	''	14/12/98
Lindsay Gordon Black, Rear of 34 Station St, Sandringham	100.00	''	14/04/97
Bretair Pty Ltd, 641 Centre Road, Bentleigh	329.20	''	10/09/98
Belaire Holdings Pty Ltd, 14 Kristen Cl, Glen Waverley	209.95	''	12/01/99
Annie Elizabeth Jarvis, 7 Beauford Rd, Red Hill	123.95	''	14/10/97
John F. Hefferan Pty Ltd, 62 Balnarring Beach Rd, Balnarring	161.35	''	30/09/98
Natasha Goold, 10 Austral Ave, Upwey	100.00	''	10/06/99
Frampton, Robyn, Mrs, 14 Johnston Street, Ashburton	318.70	''	10/05/99
Bernard McAuley, 333 High Street, Preston	100.00	''	17/03/99
Perma Ind Distributors Pty Ltd, PO Box 70, Box Hill	630.95	''	22/10/97
Ashley John Anthony Meloury, 13 Brodie St, Wangaratta	104.95	''	22/05/98
Laurence Mawson, PO Box 290, Gembrook	200.00	''	10/11/97
Mathew Taylour, 561 Canterbury Rd, Vermont	106.85	''	02/06/99
Geraldine Marie D'Orival, 2 Higgins Lane, Shoreham	147.05	''	27/10/98
Ronald Bernard Middleton, 3 Bass St, Flinders	185.75	''	26/11/97
Bernadette Ho, Unit 3 1 Bates St, Malvern East	100.00	''	27/11/97
Troy Hume, Unit 8, 14 Osborne Avenue, Glen Iris	137.85	''	04/05/99
Kim Jeanette Burchell, 45 Stirling Drv, Lakes Entrance	108.50	''	17/04/98
L. D. Calvert, 77 Seaview Pde, Lakes Entrance	135.85	''	20/11/98
Therese Cauchi, 31 Hereford Rd, Mt Evelyn	553.93	''	16/12/98
Yong Cai, Achieva Technology Aust Pl, 12 Terracotta Drive, Blackburn	109.70	''	04/03/99
Peter Andrew Hiscock, Unit 2, 23 Garrison Drive, Glen Waverley	230.30	''	26/03/99
S. Yakushi, 66 Whalley Drv, Wheelers Hill	184.55	''	28/05/97
Edna Walker, C/0 Mr G. Walker, 6 Westbrands Rd, Emerald	117.15	''	05/06/97
Andrew Cutler, 11 Ludbrook Ave, Caulfield South	171.45	''	30/11/98
Tina Hui, Factory 2, 7 Heathdale Road, Ringwood	100.10	''	07/06/99
David Angus, 20 Upper Grieve Rd, Avonsleigh	107.90	''	20/05/99
Hamid Chalid Co, Shifa Sari Saelan, Apmnt 211, 408 Lonsdale Street, Melbourne	140.60	''	17/09/98
John Richard Courtney, 29 Box Hill Crs, Box Hill North	222.70	''	31/12/97
MacLagan, Rhiannon, Mrs, Trustee of Power Trust, 7th Floor, 22 William Street, Melbourne	308.00	''	26/06/96
Robert Alexander McKay, 41B Beach Rd, Hampton	220.75	''	22/04/99
Stewart Bulmer, 28 Ponyara Rd, Mt Martha	100.00	''	03/07/98

Rodney Coppinger, 17 Dalkeith Crt, Sunbury	133.05	''	16/05/99
Clare Berenger, 5 Cornelius Street, Dandenong	115.30	''	20/05/99
Geraldine Williams, 7 Johnstone St, Malvern	148.00	''	16/02/98
Dean Chiron, 34 Danien Street, Glen Waverley	348.00	''	30/08/96
L. Delbridge, No 73 (Lot 432) License Rd, Diggers Rest	160.00	''	01/04/98
Maria Riggio, 26 Ervine Close, Sunbury	131.50	''	18/01/99
Annie Marie Jarmyn, Flat 2, 64 Hunt St, Portland	102.75	''	19/02/98
Jenny Ann Boulton, PO Box 14, Vinifera	100.00	''	18/11/98
Anthony Robert Cercone, C:O 10 Bosco Tce, Taylors Lakes	665.14	''	10/09/97
Geoffrey Michael Herriman, 238 Mc Leod St, Bairnsdale	145.00	''	07/04/98
Carmel Pignataro, PO Box 330, Wandin	200.00	''	07/11/97
George Alfred Home, PO Box 281, Red Hill South	111.27	''	25/03/98
Jennifer Kelertas, 8 Garfield Crt, Dandenong North	120.00	''	16/04/98
Tracey Ryan, 28 Anthony Gr, Woori Yallock	183.25	''	13/01/99
Ms Carolyn Maclean, T/a Cooperative Family Centre, 44 Inverness Way, Balwyn North	161.50	''	29/12/97
Twenty-Four Hour Pharmacy Pty Ltd, 4 Downton Grove, Kew	122.25	''	05/12/97
Nysse Elizabeth M., T/a Yarra Valley Dried Flowers, Lot 1, Worleys Road, Hoddles Creek	261.80	''	18/12/98
Luke Weston, 9 Nisson Crt, Somers	101.00	''	08/01/98
Carolyn Frances Patterson, Flat 2, 28 Garside St, Dandenong	153.50	''	21/10/98
John Thomas Freeman, 15 Khartoum St, Caulfield North	100.00	''	06/10/98
Sarah Judith Watts, PO Box 1079, Bendigo	150.35	''	07/04/99
Dean Robert MacKay, 12 Bruce Street, Moe	170.00	''	12/03/98
Adam Ronald Street, 37 Bendigo Rd, Kerang	137.65	''	25/11/97
Jennifer Darlow, Unit 4, 23 Cyril St, Box Hill South	300.00	''	30/04/99
Charliesworth Sebborn Williams, 569 Upper Heidelberg Rd, Heidelberg	233.09	''	23/04/99
Kathie Andrea Schnur, 1326 Main Rd, Eltham	111.35	''	29/12/98
Roundform Pty Ltd, 1 Swift Way, Dandenong South	108.02	''	18/09/97
James F. Tremewen, 94 Sixth Ave, Rosebud	165.75	''	01/09/98
Mark Gerard Bourke, PO Box 1109, Warrnambool	671.95	''	03/06/98
Lam Yam Kwok, Unit 1, 2 Barwon St, Box Hill	210.45	''	01/06/98
Dynamic Life Skills Centre, T/a Dynamic Life Skills Centre, PO Box 31, Ivanhoe	100.00	''	07/08/97
Mr R. Coleman, C/o Mt Martha Valley Lodge, 130 Country Club Drive, Safety Beach	171.40	''	25/09/97
Cate Buffinton, 94 Station Street, Mt Eliza	195.60	''	23/03/99
Mohamed Abdel-Hamid, Unit 2, 33 Sarona St, Dandenong	159.00	''	09/06/99
John Edward Scales, RMB 4583, Jeeralang North	107.30	''	11/12/98
Detlef Scheel, 128 Hillmartin Lane, Diamond Creek	112.80	''	15/02/99
Ross Michael Klapste, PO Box 2010, Research	105.75	''	07/05/98
Warrnambool Skill Share, P.O Box 698, Warrnambool	116.95	''	13/11/98
Heperlin Enterprises Pty Ltd, Bk Taylor & Co (Admin Apptd) , PO Box 6488, Melbourne, Bourke Street	727.25	''	18/06/96
Graham Williams Sports, Mr, 42B Nish Street, Echuca	884.30	''	01/04/98
Bernard Robert Dillon, 3 Evalyn Crt, Wangaratta	110.25	''	18/03/99
Danny Rodier, Uplands Road, Benambra	103.50	''	03/06/99
Dr Graham Pennington, 861 Raglan Pde, Warrnambool	145.40	''	18/06/99
M. L. Bottrell, Lot 225 Swinton St, Warrnambool	114.05	''	11/03/99
Julie Hill, C/o Hewlett Packard, 2 The Silo, Viewbank	575.85	''	30/11/98

Austpac Coating P/L Receiver Managers, Receiver Managers Acct, PO Box 781, Dandenong	1,881.36	''	19/03/98
Mark Sultana, 128 Service Rd, Moe	111.40	''	28/05/99
Daniel Robert Theissling, C/o State Trustees, PO Box 1461 N, Melbourne	900.00	''	18/02/99
Cyril William Everett, 7 Willow Street, Box Hill North	102.95	''	03/03/99
Heidi Karleen Mephram, 52 Seventh Ave, Rosebud	143.45	''	30/04/98
Catherine Mitchell, 79 Dickens Walk, Greenham, Newbury	147.98	''	22/04/99
Astra Touring Services Pty Ltd, PO Box 1304, Collingwood	211.80	''	22/02/99
Sussan Sammut, 33 Gillespie Rd, St Albans	100.00	''	17/10/97
Georgios Emtsis, 68 Fairburn Drv, Corio	109.95	''	14/01/98
Penelope Ann McIntyre, 10 Peurta Street, Burwood	117.15	''	20/11/98
Maria Ann Smith, Unit 6 35 Boolarra Ave, Newborough	230.00	''	07/04/99
The Information Specialist P/L, 405 Riversdale Road, Camberwell	123.44	''	18/05/99
Gabrielle Magliocco, 13 St James Crs, Warrnambool	138.20	''	04/11/98
Elizabeth Kastamonitis, 17 Kinlock St, Macleod	133.90	''	30/04/99
Sandra Veronica McAllion, 20 Henna St, Warrnambool	470.00	''	11/03/99
Stephney Danielle Thompson, 168 Research-Warrandyte Road, Warrandyte	108.15	''	22/06/99
Larry Alipio, 2 Wilpena Crt, St Albans	137.00	''	07/05/98
L. B. Jordan, PO Box 202, Dromana	180.10	''	25/04/99
Border Produce, PO Box 475, Wodonga	558.50	''	07/08/97
Jeff Moore, Murray Valley Glass, Unit 2, 10 South Street, Wodonga	250.00	''	21/08/97
Timothy Brendon McKean, C/o T & R Mackeen, Wild Dog Valley, Leongatha	192.57	''	20/05/99
Hank Van Rysbergen, 76 Contingent St, Trafalgar	106.75	''	16/03/99
Rajiv Abeygunasakara, Unit 3, 2 Haig Street, Burwood	110.00	''	12/06/99
Tamara Lee Butt, Unit 3, 8 Lowanna St, Wodonga	107.00	''	12/04/99
Barnawatha Hotel, 25 High Street, Barnawartha	292.20	''	31/07/98
The Whistle Stop Coffee Shop, 49 Menzies St, Wodonga	112.20	''	31/03/99
Ward Sagar Pty Ltd, Suite 21, Arthur Street, Eltham	113.10	''	24/06/99
Astra Dolta Papadopoulos, 110 Tennyson St, Kensington	100.00	''	28/09/98
Martial Height Pty Ltd, T/a The Bourke Armoury, 655 Bourke Street, Melbourne	103.15	''	18/05/99
Philip Joseph Simunitsch, Unit 2, 49 Mervyn St, Newtown	270.52	''	20/06/97
Darrielle Ann Brennan, PO Box 175, Sea Lake	166.05	''	25/11/98
Reginald James Cowie, PO Box 972, Wodonga	249.60	''	22/02/99
29 Gummon Street, PO Box 28, Vinifera	135.05	''	14/10/98
Shelley Lavita Hook, Unit 2 17 Tongue St, Yarraville	300.00	''	08/10/97
Keith Bruce Campbell, C/o Ms Roslyn Campbell, 9 Sunhill Avenue, Burwood	129.30	''	15/07/97
Devon Rankin, PO Box 488, Box Hill North	216.25	''	30/12/98
Jennifer Anne Knights, 45 Lockhart Drv, Rosebud	162.45	''	16/02/98
Sarah Judith Watts, PO Box 1079, Bendigo	112.55	''	07/04/99
Beryl Matthews, Lot 8 5 Gleneagles Crt, Croydon	208.15	''	02/02/98
Sue Maree Stokes, 20 Francis Street, Horsham	142.45	''	23/04/98
Andrew Neil Skinner, 5 Reserve Rd, Hawthorn	166.19	''	20/02/98
John Russell, PO Box 82, Surrey Hills	130.30	''	14/10/97
Philip Blain, 62 Liebig Street, Warrnambool	130.85	''	05/08/97
Megan Dorothy Ware, 572 Whitehorse Rd, Surrey Hills	145.25	''	08/04/98
Lyne Cocking, Unit 2 23 James Street, Dromana	100.00	''	20/11/96

Angela T. Faraci, C/o Pips Cutting Room, Shop 12, Safeway Arcade, Swan Hill	134.36	''	08/04/99
Wendy Elizabeth Kortman, C/o Faculty of Education, Deakin University, Warrnabool	135.00	''	13/11/97
Mercantile Agent, Chris Waud, Floor 1, 140 Burwood Hwy, Burwood	138.45	''	25/05/98
Faulkiners Stockbroking, 376 Flinders Lane, Melbourne	250.22	''	06/01/99
Ashwood Motors Pty Ltd, Numeny Ltd, 24 Ireland Street, Burwood	117.85	''	06/05/99
Dusko Masalkouski, Unit 2, 11 Rule Cl, Mill Park	120.95	''	01/02/99
Freshkept Technologies Pty Ltd, 5 Mason Sq, Warragul	168.35	''	25/05/99
Sylvia Tina-Maree Munn, 63 Arthur St, St Albans	239.30	''	06/08/98
Structered Assett Management, 10th Floor, 379 Collins Street, Melbourne	150.00	''	11/11/97
Mr M. Sutherland, 11 Warrina Ct, Burwood East	270.30	''	30/03/98
Context Pty Ltd, PO Box 193, Brunswick West	140.00	''	24/11/97
Ted Argyle, T/a Adrenalin Martial Arts, Rear 198-200 Timor Street, Warrnambool	175.35	''	02/11/98
Ann Marie Hand, 76 Ross Street, Dandenong	252.00	''	29/04/98
Steven Saminaden, 282 Betula Ave, Mill Park	181.05	''	28/10/98
Kate Gaffy, RMB 1535, Murchison	248.19	''	22/10/97
William John Wookey, 11 Village Walk, Vermont South	256.40	''	12/11/98
Ruth Jay, 3 Farrell Avenue, Yarra Glen	102.35	''	25/09/97
Beryl Burke, 154 Clarendon St, Thornbury	105.15	''	16/10/98
Ken Richards, 10 Greenwood Street, Burwood	121.10	''	06/04/98
John Vincent Lear, Lot 663, 2 Mountain View Cl, Croydon	133.65	''	30/03/98
Bhavani Pathmakalendran, 4 Ellerslie Ct, Mill Park	537.15	''	10/11/97
Zlatko Mehmedbegovic, Unit 7 4 Edith St, Dandenong	544.95	''	08/07/97
Micro Maintenance Pty Ltd, Suite 3, 26 Rutland Rd, Box Hill	149.00	''	22/03/99
Robert H. Davie, 138 Victoria Street, Warragul	118.45	''	20/03/98
Gerard Zoutendyk, C/o The Salvation Army, 30 Gillard Street, Burwood	110.30	''	22/05/98
Lynette Gail Woolcock, 61 Central Ave, Croydon	130.55	''	22/09/97
Daryl Robert Davey, 105 Hyland Street, Warrnambool	101.40	''	27/04/98
Howard Sinclair, 15 Lindaway Pl, Tullamarine	332.25	''	08/04/99
M. Nicola, 19 Roslare Pde, St Albans	253.35	''	31/01/98
Amanda Florence Hutchinson, 8 Jingella Ave, Ashwood	131.25	''	28/08/98
Damien John Magee, 3 Griffiths Crt, Mt Waverley	150.95	''	27/08/96
Anna Touhy, C/o 37 John Street, Elwood	148.50	''	09/10/97
Peter Phillip Grundy, 28 Gibney Street, Maffra	262.45	''	19/02/98
Fowles Purdy Pty Ltd, Gordon Luck Avenue, Altona	229.25	''	16/04/99
Caffe E. Cucina Vita, 32 Gertrude Street, Fitzroy	188.19	''	24/04/97
Department of Eductation, Rialto Towers South, PO Box 4346, Melbourne GPO Private Bag	220.70	''	22/10/97
Scott Plummer Pty Ltd, 1357 Centre Rd, Clayton	146.65	''	20/01/99
Terry Caufield, 9 Mangans Rd, Lilydale	150.00	''	20/01/98
F. M. C. (Australia) Ltd, Box 27, Rosebank, Clayton	189.35	''	07/08/97
Mrs Helen Sanders, 60 Power Avenue, Ashwood	134.30	''	27/05/99
Pettina Joanne Finnis, 37 Inverness Rd, Mt Evelyn	129.35	''	14/05/97
Industrial Brushware Pty Ltd, 542 Somerville Rd, Sunshine	446.50	''	18/12/98
Lynn Koh, Unit 1, 999 Dandenong Rd, Malvern East	159.85	''	04/12/98
Frederick Atkin, 11 Regent Street, Ascot Vale	100.45	''	29/06/98

Anastasios Spanos, 9 Tyrone St, South Yarra	119.15	''	25/03/98
Melinda Anne Smith, 350 Robinsons Rd, Baxter	100.00	''	02/10/98
Thyssen Haniel Logistics P/L, 335B Miac Bldg International Dr, Tullamarine	240.00	''	27/10/95
Dalal Enaty, Unit 3, 22 Springvale Rd, Nunawading Inscorp Financial Services, PO Box 99 Market Street Post Office, Melbourne	181.55	''	04/05/99
Daryl Rodney Phillpot, 8 Hunter Ave, Black Rock	113.45	''	13/06/96
L. P. & A. Straatman, PO Box 81, Neerim South	218.30	''	23/01/99
Mr Frank Metcalf, T/a Bodyline Fitness Centre, 42-44 Parklane Avenue, Traralgon	182.35	''	15/06/99
Ashley Arandez, PO Box 356, Williamstown	1,080.00	''	22/09/97
Joel Becker, Unit 8, 1 Marshall Pl, Clifton Hill	407.95	''	07/05/98
Robert Gale Productions Pty Ltd, 25 Paschall St, Moorabbin	187.15	''	05/03/99
Ha Luu, 21 Wood Street, Avondale Heights	137.40	''	18/12/98
Lenee Pty Ltd, T/a Plunkett Road Autos, 18 Cromwell Drive, Rowville	112.55	''	27/05/98
Barry Hayes, 71 Cornwall Rd, Sunshine	103.74	''	16/12/97
Pernilla Leth, PO Box 2077, St Kilda	280.56	''	28/05/99
Peter Robert Phillips, 19 Renshaw Dr, Eltham	137.10	''	19/06/97
Swiss Club of Victoria, C/- A. Forster, 89 Flinders Lane, Melbourne	717.90	''	11/12/98
L. C. Blackman, The Estate of Mr L. C. Blackmann, 69 Kiewa East Road, Tangambalanga	200.00	''	30/01/98
Mandie Carolyn Hawkins, 5 Secomb South Place, Footscray	116.05	''	25/11/98
Jeyalinjam Verakathy, Unit 6, 304 Corrigan Rd, Keysborough	100.20	''	25/07/97
Bruce Henderson, 18 Mynong Crs, Toorak	100.00	''	17/12/97
Wendy Dawn Benbow, 35 Harriett St, Horsham	188.08	''	02/06/99
Liala Margaret Burnell, Mount Martha Nursing Home, The Esplanade, Mt Martha	162.10	''	07/05/99
Bianca Lee Jones, 14 Forsyth Ave, Horsham	123.00	''	22/10/97
Tony Chan, 37 Outlook Road, Mt Waverley	135.30	''	06/05/99
Peter Noue Hatini, 10 A Oldfield St, Sunshine West	120.75	''	29/03/99
Anton Kormoczi, 43 Canberra Street, Moe	200.00	''	28/08/97
Sin Ling Lung, 135 Capital Ave, Glen Waverley	144.00	''	17/06/99
Meridian Projects Pty Ltd, 10 Spring St, Fitzroy	362.50	''	09/07/98
Natalie Hanlon, 27 Huntly St, Moonee Ponds	130.53	''	23/04/98
Creative Fitness Marketing Pty, Suite 2, 30 Walker Street, Dandenong	196.35	''	09/11/98
John Burgess, Drive Thru Dry Cleaners, 118 Wilson Street, Horsham	1,303.90	''	14/07/97
Ivan Sankovic, 2/25 Wingate Avenue, Ascot Vale	116.75	''	13/04/99
James Scott Mathewson, 22 Wellman St, Box Hill South	123.00	''	09/06/99
Eco. Public Awareness, David Sy, National Eco Public Awareness, 164 Spencer Street, Essendon	173.05	''	03/04/98
Mr. Alexander George McLean, 61 Darling Road, Malvern East	1,245.89	''	10/07/97
Terry Tass Pty Ltd, 66 Koornang Rd, Carnegie	180.00	''	01/04/98
G. B. Products P/L, PO Box 590, Sunshine North	171.75	''	20/05/99
Kevin Tom Dixon, 10 Cooper St, Sunshine	1,246.95	''	13/05/99
Nichole Anne Patterson, 8 Jepp Crt, Traralgon	100.00	''	12/06/98
	171.65	''	27/11/98

Maximillian's Woodfire Pizza & Restaurant, 32 Gertrude Street, Fitzroy	140.41	"	10/12/98
Phillip Douglas Webster, Unit 7, 95 St Leonards Rd, Ascot Vale	124.20	"	19/03/99
Melanie Bernadett E. Ferguson, Lot 7, Whites Rd, Smythesdale	110.00	"	31/05/99
Darren Scott Sheppard, 31 Bodkin St, Kyneton	307.80	"	25/05/98
Richard Marshall, 17 Ashburton Drv, Mitcham	107.40	"	24/05/99
Agnes Mary Mathews, 189 A Victoria St, Ballarat	330.00	"	24/12/98
Anton Kezerle, 83 Erinbank Crs, Westmeadows	111.55	"	30/10/98
E. F. Rankin, PO Box 903, Portland	266.85	"	21/04/99
Loucarm Pty Ltd, Level 1, 465 Auburn Rd, Hawthorn East	116.35	"	04/03/99
Ellen Chen, Unit 16, 77 Queens Rd, Melbourne	483.91	"	20/11/96
Ann Thom, 6 Balmoral Street, Braybrook	348.00	"	21/08/98
A. Cini, 19 Larissa Ave, Tullamarine	138.15	"	23/06/99
Graham Albert Sherwell, 19 Oswald St, Portland	126.00	"	30/06/98
Katie Kelly, 15C East Street, Ascot Vale	108.85	"	11/06/99
Matthew Bernard Pini, 28 Sylvander St, Balwyn North	167.25	"	21/06/99
Timberland of Australia P/L, PO Box 194, Market Street PO	377.10	"	05/05/99
Tracey Stanton, 7 Cousen Pl, Gladstone Park	281.20	"	25/05/98
Annabelle Philomena Poutsie, PO Box 5, Seddon	115.80	"	27/04/99
Anna Flood, Unit 15, 41 Kent Street, Sebastopol	104.30	"	07/05/97
Mr Mayne Nicholas Express, Lot 3, Lewis Crt, Smythes Creek	143.05	"	06/02/98
Graham Steven Glassford, 5 Glen Street, Essendon	108.10	"	15/06/99
Mr Peter T/a Exclusive Hats JTs, 520 Malvern Rd, Prahran	165.10	"	29/03/99
Solesbury Pty Ltd, 35 Claremont St, South Yarra	110.50	"	10/11/97
Texas Lake Pty Ltd, 20-22 Stanley St, Collingwood	100.50	"	26/11/98
Debra Ann Murray, Unit 1, 121A Johnson St, Maffra	200.00	"	29/04/99
Camelot Cellars, T/a Camelot Cellars, 11 Churcher Crt, Mt Waverley	592.84	"	13/08/97
The Copier Shop, Mr Philip Anth, The Copier Shop, 10 Clipper Ct, Ringwood North	103.78	"	25/03/98
E. Doherty, 142 Wellington Street, Kew	123.50	"	13/01/99
Mr Dejongh John, T/a Prahran, 61 St Johns St, Prahran	103.05	"	01/12/98
Veniloue Vulolovuki, Flat 106, 56 Derby St, Kensington	100.00	"	10/10/97
Michael Andrew Jennings, Unit 1, 65 Talbot Rd, Mt Waverley	107.15	"	31/10/97
Fergus Deans, 136 Durham Rd, Sunshine	140.20	"	03/02/99
Dale Walton, 17 Diana Drive, Blackburn North	203.65	"	10/11/98
Ivan Kalozi, 237 Glengala Rd, Sunshine	211.50	"	15/04/98
James Knight, Unit 1, 17 Bernard St, Mount Waverley	120.00	"	04/09/98
Sebastiano Rocko Palermo, 27 Luscombe St, Brunswick	153.35	"	14/07/97
Mario Karaolides, 19 Errol Street, Braybrook	121.00	"	12/11/98
Sau Fong Yeung, 503/350 Latrobe St, Melbourne	137.75	"	27/04/98
Vu Uy Ngyen, Rear 430 Ballarat Rd, Sunshine	391.80	"	29/04/99
Mr David A. Norton Argo's Road Screen Repairs, PO Box 619, Portland	321.96	"	03/09/97
Ultimate Distribution Aust. Pty, Showgrounds Epsom Rd, Ascot Vale	177.77	"	16/11/98
Paul Laspas, 6 Westbrook Street, Chadstone	250.00	"	26/06/97
Geoffrey Shane Cooper, 166 Glenlyon Rd, Brunswick East	133.15	"	20/10/98
Sharon Ann Park, Unit ,2 23 Walker St, Brunswick West	120.60	"	07/08/98

Tammy Louise Hutchinson, 34 Roberts Crs, Sunshine West	157.50	''	29/10/98
Oliver Wong, 459 Wattle Tree Road, Malvern East	118.10	''	24/11/98
Ann Sheilds, PO Box 140, Stratford	153.60	''	08/10/97
Annie Grace Coltzau, Unit 3, 63 Mc Pherson St, Horsham	740.00	''	09/04/99
James Clark, Lot 2, Cooloongatta Drv, Tyers	104.25	''	24/09/98
Stephen Barling, C/- Victoria Rehab. Centre, 499 Springvale Road, Glen Waverley	139.35	''	30/12/98
Andrew Clode, 160 Dooen Rd, Horsham	227.05	''	31/05/99
R. D. Woodruff, PO Box 100, Torquay	159.80	''	09/03/99
Christopher Justin William Paul, 12 Clarkson Ave, Brighton	262.95	''	14/08/98
Sharon Louise Barry, PO Box 736, Tullamarine	158.35	''	11/06/98
Mirella Mancini, 43 Gordon Street, Tullamarine	131.05	''	17/09/96
Andrew Clarke, (Sole Trader), 4 Eumarella St, Tullamarine	119.40	''	10/05/99
C. L. Schoenmakers, 35 Second Street, Clayton	117.60	''	22/07/98
J. & G. Filipou Nominees, PO Box 77, Oakley	134.75	''	22/01/99
Nghia Phuong Nguyen, Unit 3, 22 Forrest St, Sunshine	150.00	''	07/08/97
N. G. Georgeson, 14 Catherine Ave, Mt Waverley	100.00	''	23/08/96
Susan Maree Pearce, 12 Blair Court, Keilor	134.22	''	18/01/99
Fudcoma Pty Ltd, Fact 6 124 Keys Rd, Cheltenham	108.20	''	02/03/99
Barry Patrick Smyth, 11:153 Epsom Rd, Ascot Vale	100.00	''	12/02/98
Debra Rigby, 249 Carrick Drive, Tullamarine	118.35	''	28/10/97
Mary Elizabeth Kennedy, C/- T. Glynn, 71 Keys Road, Keysborough	381.65	''	04/06/97
John Robert Hayball, Flat 4, 24 Larnook St, Prahran	162.95	''	07/08/97
Stuart Briggs, Unit 4 24 Clarinda Rd, Essendon	154.45	''	19/05/98
P. J. M. Engineering Service Pl, 73 Sarton Rd, Clayton	1,061.70	''	20/11/97
Graham Sherry, Floor 6, Flat 1, 1 Exhibition St, Melbourne	100.76	''	26/09/97
A. Freund, 192 The Esplanade, Brighton	536.65	''	23/05/97
Frederick Bentley, 451 Melbourne Rd, Newport	192.90	''	30/09/97
Margaret Carter, 326 Hampton St, Hampton	351.60	''	28/08/97
Steven Sawilski, Unit 4, 147 Westbury St, Balaclava	150.00	''	13/11/98
Thomas Allan Eley, 393 Frankston Dandenong Rd, Frankston North	149.05	''	01/02/99
Lorraine Hynes, 5 Gent Street, Yarraville	157.35	''	12/05/99
Haycom Pty Ltd, 13 Testar Gr, Caulfield North	147.90	''	16/11/98
Matthew Joel Antoine, 223 Yarra Street, Geelong	106.45	''	12/04/99
Shinichi Odo, 8 Kent Avenue, Brighton	141.65	''	27/02/98
Dolso Constructions Pty Ltd, Floor 1, 347 Elizabeth Street, Melbourne	569.21	''	08/10/98
Tifani Hair Design, 104 Grimshaw Street, Greensborough	218.75	''	14/05/99
Mart Pamonmontri, Unit 2, 201 Wellington Pde S, East Melbourne	105.55	''	17/12/97
Stephen Marshall, 7 Andrews St, Geelong West	144.25	''	13/05/99
Mr John Kevin Niblett, Phosphate Shed, Hamilton Hwy, Lismore	365.00	''	23/07/97
Justine Anne Hellenen, 18 View Street, Reservoir	168.15	''	27/04/99
Joanne Young, 12 Hector Street, Geelong West	120.00	''	18/11/98
Mr Darryn Cutting, Flat 3, 3 Cooba Street, Canterbury	136.90	''	18/05/98
N. L. Buhagiar, 9 Beatrix Street, Greensborough	120.15	''	23/10/98
Kerrie McAllister, 9 Liberty Crt, Diamond Creek	163.30	''	31/12/97
Manuel Ladas, 78 Marigold Ave, Altona North	149.30	''	16/04/99
Ansonic Electronic Pty Ltd, 457 Raglan Parade, Warrnambool	359.94	''	19/08/97

Lauren May Beverly, 32 Alexandra St, St Kilda East	173.77	''	28/01/98
Justin St Leger Kelly, 119 Park Street, Abbotsford	166.65	''	16/03/98
Paula Jane Keane, Lot 1, Back Valencia Creek Rd, Boisdale	104.45	''	08/12/98
Far Eastern Gourmet, Shop 114A, Grnsborough Plaza, 25 Main St, Greensborough	103.95	''	01/03/99
Mr Tony Anderson, Level 7, 414 Bourke St, Melbourne	112.60	''	26/03/98
Norman Jowett, 145 Ninth Street, Mildura	277.35	''	30/06/99
Beda Rust, 1 Julie Crt, Warrnambool	165.55	''	11/01/99
Maria Vrabcenjak, 22 Welliesley Drive, Taylors Lakes	127.05	''	27/01/99
Fingers Classy, 28 Hardware Street, Melbourne	109.85	''	09/11/98
Ivan Mehrtens, Unit 1 32 McBain Street, Altona	174.65	''	09/03/99
Marie Jones, T/a C/J Star Jeans, 67 Mahoneys Rd, Forest Hill	133.25	''	06/04/98
H. Polizos, 20 Coleman Avenue, Mildura	183.00	''	26/09/97
Karen Ryan, 7C Bay Road, Sandringham	112.70	''	21/12/98
Philip Daymond, 41 Langtree Ave, Mildura	122.20	''	23/12/98
R. Raze, PO Box 315, Abbotsford	114.90	''	27/05/99
E.W. & K.J. Fox Pty Ltd, 26 Odessa Street, St Kilda	113.20	''	04/11/98
Contessa Daley, PO Box 454 CP, Mildura	115.50	''	03/03/99
Sarah Wilcox, Unit 3 4 Raith Ct, St Kilda East	166.70	''	16/12/98
Andrew Douglas Pratten, 266 Albert Rd, South Melbourne	123.30	''	30/09/97
Camilla Zappacosta, Unit 3, 17 Stevens St, Mildura	100.01	''	20/03/99
Vanessa Ann Hatfield, Unit 2, 1 Sargent Ave, Mildura	150.00	''	23/12/98
Joshua Cameron Millen, Floor 4, 157 Moorabool St, Geelong	360.15	''	30/03/99
Siri Louise Carty, 99 High Street, Lismore	240.00	''	05/06/98
Andrew Williams, Unit 4, 106 Royal Pde, Reservoir	137.30	''	05/06/98
Rosa Marchetti, 55 Lonsdale Street, Melbourne	104.00	''	30/03/99
Steven Iverson, 23 York Street, Moonee Ponds	156.70	''	26/09/97
Catarina E. Agin, 84-108 Astons Rd, Yarrambat	113.65	''	31/05/99
Robert Murphy, Unit 1, 60 Grieve Pde, Altona	200.00	''	26/11/97
Melbourne Central Executive Suites, 222 Latrobe Street, Melbourne	107.65	''	17/04/98
J. Maiore, 57 Schutt Street, Newport	100.00	''	30/10/98
Ambi Thind, Level 2, 412 Collins Street, Melbourne	173.65	''	20/04/98
Cervin Pty Ltd, Level 2, 491-495 King St, Melbourne	506.29	''	27/04/98
Shop-A-Docket Pty Ltd, 63 Riverside Rd, Hawthorn	103.60	''	28/05/99
Eng Huat Ong, 133 Gheringhap Street, Geelong	159.16	''	23/11/98
Food Service Machinery Pty Ltd, 54 Duerdin Street, Clayton North	117.80	''	11/02/99
Nillnthi Shrimpton, Flat 8, 20 Orange Gr, Balaclava	150.00	''	29/12/97
Liam James Clifford, 10 Hammond Street, Brighton	132.95	''	14/05/98
Michael McCahill, 7 Well Street, Brighton	116.05	''	03/06/98
Mrs V. Peters, 171 Moorabool Street, Geelong	185.75	''	03/03/99
Cynthia Grasso, Unit 26 20 Edmonds Road, Prahran	150.20	''	24/12/98
Graham Pratt, Unit 4, 200 Edwardes Street, Northcote	575.00	''	25/05/99
Dorothy Marie Hompas, Unit 2, 16 Middleton St, Black Rock	108.15	''	15/07/97
The Treasurer, 253 St Kilda Street, Brighton	105.27	''	27/09/98
Virginia Farrell, 3 Garnet Street, Essendon	110.45	''	07/08/97
McKimm Developments Rockton, Unit 15, 225 Beconsfield Pde, Middle Park	178.90	''	17/12/98
Benny Negro, 121 Darebin Bly, Reservoir	106.35	''	21/12/98
Peiront Zhao, 6 Cliveden Crt, Thomastown	112.85	''	03/06/99
Anthony John Panetta, 8 Hale Street, Kew East	186.95	''	23/04/99
Gerald Bondici, 7 Nevern Crt, Mill Park	225.45	''	09/04/98

B. H. Kemp, PO Box 525, Berwick	121.45	''	22/06/99
Warren West, 1 Fernshaw Pl, Sunbury	135.95	''	12/04/99
Trawalla Pastoral Co, P O Box 185 Box Hill	122.60	''	24/06/99
Jenny Matthew, Unit 2, 9 Ostia Ct, Thomastown	100.00	''	18/08/97
John Gunn, 50 Balmain Drive, Berwick	114.90	''	29/06/99
Kate Anderson, 2 Carcoola Crt, Rosebud	136.90	''	08/05/98
Salvatore Logiudice, 458 Bell St, Pascoe Vale South	135.35	''	30/12/98
The Australian Ostrich Co. Ltd,			
Subject To Doca, 197 Riversdale Rd, Hawthorn	244.25	''	22/12/98
Debbie Reinhardt, 51 Hodgkinson St, Clifton Hill	212.30	''	06/05/99
Darren Patterson, 54 Bendoran Cres, Bundoora	139.70	''	17/12/98
Sandra Howells, Building 1, Brandon Park Office			
530 Springvale Road, Glen Waverley	184.00	''	09/12/97
David De Prada Ltd 105 Anderson Rd, Sunbury	122.70	''	29/06/99
Site Australia Sales Pty Ltd, 336 Rae St, Fitzroy North	521.96	''	20/09/96
Rebecca Fairey, Unit 2, 7 Lambeth Pl, St Kilda East	166.75	''	08/11/96
Ammanda Field Co, Mr A. J. Field,			
306 Hotham Road, Portsea	242.35	''	24/03/99
Raymond Beardon, 47 Naples Rd, Mentone	104.14	''	07/07/98
Britta Schwarzenholz Ll B&G, 21 Railway Pl, Coburg	181.25	''	27/04/99
Margaret Sampson, 73 Hubert Ave, Glenroy	408.47	''	01/06/99
H. Burton, 11 Epsom Road, Mordialloc	106.85	''	31/03/99
Longbeach Roofing Services Pty Ltd,			
Factory 3, 271 Boundary Rd, Braeside	136.70	''	27/10/98
Kwee Lau, 2 Rolls Crt, Glen Waverley	108.40	''	16/04/99
Ruslan Iksanov, 7 Sydney St, Clayton South	125.40	''	31/12/98
G. J. Brown, P.O. Box 925, Frankston	112.25	''	17/06/99
D. Borg, Unit 1, 14 Reddrop Crt, Laverton	165.05	''	06/01/98
Dell McFarlane, Unit 61, 8 The Esplanade Nr St Kilda	117.57	''	04/05/99
Kerryn Aworth, 306 High Street, Avoca	138.55	''	18/12/97
M. V. Littlejohn, (DC&C) 21 Kunyung Rd, Mt Eliza	190.55	''	27/04/99
Karen McNiece, 3 Merion Court, Rowville	142.80	''	27/04/98
Vanessa Christine Mol,			
C/o Mr Christopher Frost, Post Office, Corop	102.25	''	11/02/99
MacKie, Gaye Bruce, Upstairs, 274 St Kilda Rd, St Kilda	120.40	''	18/12/98
Sarah Lesley, 117 Mitford Street, Elwood	185.10	''	17/03/99
Conrad Szczepaniak, 9A Hopkins St, McKinnon	158.55	''	03/05/99
Enid Helen Linnell, C/- Ms K. Glennen,			
32 Marine Pde, St Kilda	170.25	''	03/03/99
Karen Merkel, 20 Grattan Street, Prahran	239.65	''	15/04/98
Glen Michael Jackson, PO Box 519, Wonthaggi	150.45	''	09/06/98
Michael Booth, 78 Graham Street, Wonthaggi	204.10	''	23/03/99
X-Pert Software Pty Ltd, 7 Pike Pl, Bacchus Marsh	116.60	''	''
Con Demetriuo, Unit 2, 35 Wareham St, Springvale	100.00	''	23/09/97
Sue Appleyard, 8 Mercury Cres, Newcomb	240.00	''	08/06/99
Peter Devonshire, Unit 4, 13 Fosters Rd, Keilor Park	129.45	''	20/02/98
Vivienne Mary Lewin, 22 Surgey St, Merbein	103.00	''	23/04/99
V. M. Koponen, 46 Cecil Street, Williamstown	129.45	''	29/04/98
Suwat Piriyaatgul, Unit 6, 14 Stawell St, Ballarat	500.00	''	10/11/97
Edna Joy MacFarlane, Government Rd, Wonthaggi	239.35	''	20/10/98
Elias Abboud, T/a Astron Glenroy,			
774 Pascoe Vale Road, Glenroy	223.05	''	16/09/97
Gerald Lepkowski, 33 Inkerman St, St Kilda	100.00	''	01/02/99

Nga Thi Thuy Pham, 223 Clayton Rd, Clayton	100.00	''	09/06/99
Danny Kerion Baker, 1493 Dargo Rd, Walpa	105.50	''	27/05/97
Joseph Andrew Connelly, RMB 5750, Riverview Rd, Heyfield	294.45	''	08/10/97
Duc Dzung Dang, Unit 4, 41 Brougham St, North Melbourne	105.75	''	10/06/97
Tony Tesoriero, 70 Macgregor Street, Malvern East	160.15	''	09/04/99
Richard Daniel Primrose, Unit 1, 3 Taylor Ave, Aspendale	209.20	''	18/11/98
Graeme C. Last, 22 Jacksons Road, Mt Eliza	113.85	''	25/05/99
J. C. England, 7 Eliza Tce, Mt Eliza	109.85	''	03/02/99
Halim Hakim, 13/38 Wells St, South Melbourne	666.77	''	28/05/97
Criag Kim Wainwright, C/o APS, PO Box 35, Highett	256.90	''	11/02/98
Rita Muriel Evans, 75 Shirley Street, St Albans	414.60	''	13/10/98
W. Elton & Son Pty Ltd, PO Box 357, Altona North	410.00	''	23/04/99
Joan Forster, 28 Rosserdale Crs, Mt Eliza	225.30	''	04/05/99
Christine Walters, 109A Back Beach Rd, Portsea	123.70	''	16/04/97
Australian Insurance Systems, 147 Parkers Rd, Parkdale	253.79	''	24/05/95
Janet Kangalis, 16 Britt Crt, Keilor East	123.35	''	01/04/99
Angela Olsson, 68 Erica Ave, St Albans	124.90	''	30/04/99
Maureen Greaves, Unit 1, 14 Callanan Drv, Melton	201.75	''	20/02/98
Pro Films No.3 Pty Ltd, PO Box 558, South Melbourne	123.60	''	13/11/95
Barbara Sroda, Flat 5, 295 Abbotsford St, North Melbourne	137.35	''	23/04/99
Scott Kingsley Sarkies, 21 Charles Drv, Pearcedale	123.60	''	20/11/98
Geoffrey William Styles, 6 Sutherland Ave, Melton South	150.00	''	24/12/97
Geoffrey D. Pledge, 11 The Helm, Frankston	131.45	''	01/12/98
Karen Harper, PO Box 16, South Yarra	100.00	''	18/08/97
Colin Habbey, 34 Neragundah Dr, Glenmaggie	199.80	''	02/03/98
Viki Silimone Lehaul, 4B Swan Hill Rd, Robinvale	176.55	''	05/06/98
Josephine Zammit, 14 Currunghi Crt, St Albans	100.00	''	15/07/97
P. R. Pritchard & Son Pty Ltd, 3/62 Dehavilland Rd, Mordialloc	162.34	''	03/12/97
Mr Emery Alan, 15 Logan Street, Maryborough	103.40	''	12/11/98
Nancy Beth Bath, 3 Sterling Ave, Highett	162.21	''	02/06/99
Practical Technology Training, 50 Rosserdale Crescent, Mount Eliza	132.40	''	05/09/95
Tracey Doublet, Unit 2, 44 Railway Pde, Pascoe Vale	110.00	''	08/09/98
Timberland Company of Aust, PO Box 194, Market St, Melbourne	412.45	''	19/05/99
Rosa Yusupov, Unit 1 11 Balaclava Rd, St Kilda East	240.68	''	22/07/97
Lynette May Toomey, Unit 6, 15 Mozart St, St Kilda	160.66	''	06/01/99
Peter Coburn, 44 Fourth Street, Parkdale	129.30	''	09/10/98
Keith Goodwin, Unit 3 95 Charles St, Ascot Vale	151.75	''	04/03/99
K. M. Toomey, C/o Mrs E. Piper, 38 Picnic St, Frankston	175.00	''	20/04/98
A. J. Blain, Unit 4, 12-14 Surrey Street, Pascoe Vale	120.00	''	20/11/97
Robin Hull, 23 Addison Street, Elwood	216.25	''	27/03/98
Wendy Ryan, 6 Lowan Crt, Frankston	100.00	''	02/09/96
Sandra Dawn Ward, C/- 146 High Street, Ararat	251.70	''	01/12/98
Cameron Australasia Pty Ltd, PO Box 789, St. Albans	192.30	''	20/04/99
Kate King, 19 Holberg Street, Moonee Ponds	152.55	''	11/11/98
Travis Peter Voigt, 45 B Osborne St, Prahran	240.00	''	08/08/96
Harrison Scott Weisinger, 66 Settlers Hill Crs, Croydon Hills	100.20	''	01/10/96
Dale Lane, 6 Webster Avenue, Croydon	376.10	''	22/01/99
Wen Wang, Unit 5, 4 Albion Road, Box Hill	173.45	''	14/04/98
N. Price, 15 Coachman Sq, Wantirna	121.70	''	05/01/98

Frank G. Kerr, 15 Pascoe Ave, Croydon	149.95	''	18/05/98
David Paul Donovan, 4 Alamein Av, Kilsyth	102.65	''	10/09/97
Joel Ryan (Sole Trader), 9 Walsh St, West Melbourne	100.00	''	29/10/98
Garry John Smith, 3 Lincoln Street, Glen Iris	169.20	''	05/06/98
Dianne Mason, 115 Uren Rd, Emerald	100.00	''	01/02/99
Ian John Foley, 4 Osbourne Court, Hawthorn	114.25	''	16/06/99
Dinesto Modesto, Kiosk K304,			
Highpoint Shopping Centre, 200 Rosamond Rd, Maribyrnong	166.85	''	23/02/98
Mercury Marine 1, Private Bag 1420, Dandenong South	483.65	''	16/11/98
Margaret Giudice, 13 Military Rd, Avondale Heights	214.35	''	21/12/98
Robert Paul Galea, 7 Haven Court, Westmeadows	183.10	''	07/08/97
Ian Emery, 14 Lantana Ave, Hoppers Crossing	481.00	''	08/12/97
Leb-Signs & Equipment Supp, B-Signs & Equipment, Unit 31, 310 Dorset Road, Croydon	200.00	''	08/10/97
Earthbound Holistic Centre, T/a Earthbound, Unit 3/25 Wallase Crescent, Essendon	105.00	''	11/08/97
James Damien Milligan, 17 Skye Rd, Wantirna	113.40	''	05/05/98
Matthew Livy, Southern Cross Cabinets, 11 Bostock Ct, Thomastown	118.80	''	22/12/98
Rick Mead, 5 Wattletree Rd, Croydon	221.75	''	01/05/98
Matilda Lazar, 29 Lyn Drive, Ferntree Gully	122.55	''	13/03/99
Belinda Anne Walsh, Unit 1/6 Lincoln Rd, Essendon	135.05	''	24/12/98
P. N. S. Graphics Australia P/L, Factory 4, 37 Lusher Road, Croydon	454.82	''	13/02/97
Debra Pace, PO Box 857, Melton	109.95	''	07/04/99
Miss Christine Walter, Lot 6, Kings Road, Kinglake West	126.80	''	11/09/97
London Joseph London T/a Waver, Fact 2, 37 Mcquarie Drive, Thomastown	110.95	''	21/04/99
S. Hutchinson, 126 Anzac Avenue, Seymour,	129.70	''	03/02/99
Mr Harry Apostolidis, 8-10 Peveril St, Brunswick	163.05	''	17/04/97
Steven Richard Smith, PO Box 1074, Croydon	121.60	''	14/10/98
De Jong, 30 Pandora Crs, Croydon	136.60	''	03/10/97
Lynne Elisabeth Wise, 30 Campbell St, Port Fairy	207.35	''	23/06/99
Underworld Australia P/L, Shop 2117, Highpoint Shopp Centre, 200 Rosamond Road, Maribyrnong	118.10	''	21/01/99
Mobiletec Pty Ltd, Trak 1788418, Shop 5, 2107-2126 Princes Hwy, Clayton	132.90	''	06/04/99
Susan Warren, 11 Nyanda Crt, Croydon	101.00	''	18/05/98
Sandra Doris Jenkins, Factory 2/1, Eastgate Ct, Knoxfield	143.45	''	21/10/98
Ranjit Singh, 10 McCathy Crt, Wallan Wallan	144.05	''	28/11/97
Scott Peter Archer, 1 Kulanda Crt, Patterson Lakes	206.20	''	24/03/99
Yvette Natasha Zamburro, 30 Grange Road, Blackburn South	452.00	''	09/08/96
Bozena Serwecinska, 3 Burwood Highway, Wantirna	147.75	''	21/06/99
Paul Whittaker, 78 Roseman Road, Chirnside Park	112.15	''	09/11/98
Martin Stephen Johnson, 36 Back Kyneton Rd, Heathcote	133.45	''	22/02/99
Dominic Ciccone, PO Box 590, Thomastown	247.35	''	15/09/97
Meredith Katherine Lott, Lot 26, Roditis Ave, Broadford	106.01	''	04/01/99
Comcare, Suite 4, 75 Bay Street, Brighton	199.85	''	19/06/99
Denis Patrick Paton, 4 Railway Street, Violet Town	110.25	''	02/04/97
Virginia Burford, PO Box 873, Melton	103.55	''	24/11/98
Justin Peter Clift, 25 Tennyson Ave, Kilsyth	113.51	''	21/05/99
John Robert Dimock, Suite 7, 11 Beach St, Port Melbourne	160.50	''	07/08/97
Adam Wyles, 2 Beaumont Crt, Montrose	104.45	''	17/05/99

Fai Choon Goh, (C&C)Tyl, 62 Freemantle Drv, Wantirna South	140.03	''	19/05/99
P. Bei, Lot 17, Taliska Crt, Bellarine Hwy, Wallington	136.05	''	04/06/99
Brian Barnes, 400 Wallington Rd, Wallington	189.25	''	30/12/98
Cveta Stefanovska, 75 Pandora Ave, Thomastown	100.00	''	11/09/98
Paul R. Haw, PO Box 184, Boort	104.30	''	19/05/99
Valimanda Pty Ltd, PO Box 14714, Melbourne City MC, Melbourne	150.00	''	22/03/99
Andrew Carr, RMB 3220, Cross Road, Numurkah	150.80	''	01/03/98
David Grant Sanderson, 55 Peterho Blv, Point Lonsdale	113.51	''	29/01/99
Louise Alexandra Anderson, PO Box 360, Shepparton	204.85	''	21/11/97
Helen May Kelly, Pyrenees Hwy, Newstead	110.00	''	02/04/98
Lourraine Robinson, 36 Driscolls Rd, Ardeer	112.95	''	04/03/99
Paul Radcliff, 119 Station Road, Melton	100.00	''	04/12/98
Ross Ian Atkins, 32 Vernon Street, Croydon	132.65	''	23/12/98
Jodie Elizabeth Curtis, RSD 27, Boort	178.05	''	20/02/98
Joseph Elmalek, 5 Norton Street, Ardeer	100.00	''	04/02/99
Techniplan Telecontroc, 14 Collins Pl, Kilsyth	444.90	''	27/11/98
Wayne Bowes, 79 Westcott Pde, Rockbank	197.00	''	25/02/99
Salimata Said, Unit 2, 26 Burns Street, Maidstone	100.00	''	30/10/97
Michael Harper, Unit 4, 28 Dering St, Diamond Creek	100.25	''	09/03/99
R. B. Shickerling, State Trustees, Attn A. Cooke, 168 Exhibition Street, Melbourne	101.55	''	02/03/99
Mohamed Sherrif, 20 Fulford Street, Wodonga	177.75	''	23/01/98
Paul Waack, 12 Westcott Pde, Rockbank	114.25	''	19/05/98
Tonianne Sayer, 38 Fraser Street, Melton	100.00	''	04/08/98
Lou Zileski, 61 Saratoga Crs, Keilor Downs	128.00	''	11/05/99
Michael Barrett Clothing Pty Ltd, 4 Tower Pl, Hawthorn East	318.15	''	27/05/99
Virginia Wilson, 114 Drummond St North, Ballarat	163.30	''	27/01/99
Anthony Thomas Frawley, RMB, Bungaree	155.90	''	14/04/98
Three Bridges Timber Pty Ltd, Level 1 395 Station Street, Box Hill	204.95	''	21/05/99
Security Merchants Australia P/L, PO Box 754, Mount Waverley	612.30	''	11/11/97
Jay Dee Fashions Pty Ltd, PO Box 1041, Werribee	983.75	''	23/03/99
Darren Levy, 759 Orrong Rd, Toorak	202.30	''	09/03/99
Mr P. J. Liston, RMB 264, Golf Field Rd, Beulah	1,187.15	''	12/02/99
Tim Harrison, 12 Elizabeth Street, Wendouree	102.90	''	08/04/98
Greensborough Bowling Centre, 445 Grimshaw St, Bundoora	172.68	''	06/04/99
Somerset Crossing Cellars Pty, 10 The Eyrie, Eaglemont	144.75	''	08/12/98
Ross Nelson Grace, Unit 2, 882 Glenferrie Rd, Kew	1,014.30	''	13/05/99
Mr J. M. Heslop, 40 Clark Street, Colac	132.10	''	30/03/99
Stuart James Campbell, 37 Ryeburne Ave, Hawthorn East	140.00	''	13/10/98
Mr Desmond Francis Kelly, Corcoran Rd, Garfield	137.45	''	28/11/97
Siral Pty Ltd, 118 Surrey Rd, South Yarra	188.40	''	20/04/99
Brian Forshaw, 37 Lansell Rd, Toorak	304.90	''	08/01/99
Stegbar Pty Ltd, PO Box 373, MDA, Knoxfield	116.90	''	12/11/98
Craig D. Nott, 4 Garyth Crt, Belmont	195.25	''	27/10/98
Gavin Jenner, 190 Upper Heidelberg Rd, Ivanhoe	130.80	''	26/05/99
Mr Brian Walker, 399 Blackshaws Rd, Altona	465.90	''	06/05/98
Erin Corporation Pty Ltd, T/a No Knead Bread Making, 17 Pakington St, Geelong West	126.69	''	05/01/99

John Leith Gillies, 27 O'Donohue Rd, Anglesea	127.00	''	16/02/99
Always Powder Coating (Vic) Pty Ltd, 18 Hunter Street, Kew East	221.15	''	08/04/99
Andrew Lopez, 31 Scheele St, Surrey Hills	125.95	''	21/04/98
Helen Maree New, 14 Hughes St, Brighton East	129.60	''	06/04/99
Gallan Nominees Pty Ltd, 11 Vine Street, Eltham	158.45	''	29/03/99
Alex Mitchell, The Anchorage, 8 Murtons Way, Port Melbourne	180.00	''	15/05/96
Kevin John Cosier, 7 Grange Rd, Toorak	108.60	''	11/01/99
Thomas Leslie Griffiths, RMB 1255, Mooleric Road, Birregurra	125.15	''	22/06/99
Leigh Kelly, 412 Waterdale Rd, Heidelberg West	100.15	''	16/11/98
Helen Margaret Wilson, 10 Meakin St, Geelong East	108.00	''	19/01/98
Joanne Davidson, T/a Bali Blue, 24 Bridge Mall, Ballarat	140.00	''	02/03/99
Paul David Stewart, 136 Skene Street, Newtown	168.00	''	23/11/98
Thomas Phillip Roth, 28 Kent Street, Richmond	160.75	''	21/07/97
Gane Charles Ahern, C/o C. & R. Hal, Lot 2, Eastview Avenue, Seville East	100.00	''	24/03/99
Richard James Fitzgerald, Lot 1 Ahern Rd, Pakenham	182.50	''	12/10/98
Jeffrey Hamilton, 93-95 Gold Reef Mall, Stawell	134.20	''	29/01/99
Lee Amrien, 94 Devenish Rd, Boronia	100.00	''	08/10/98
Michelle Evans, 10 Mitchell Avenue, Boronia	200.00	''	21/10/96
Jennifer Middleton Property Trust, 32 Aldinga Street, Blackburn South	121.00	''	05/11/97
Gerhard Gosens, 1 White Street, Longwarry	132.10	''	09/10/98
Rebecca Elizabeth Hill, Unit 7, 80 Cromwell Rd, South Yarra	110.20	''	29/06/99
Kevin J. Moulynox, PO Box 175, Stawell	327.50	''	06/04/99
Stefan Gunev, 4 Carson Avenue, Mont Albert	200.00	''	30/04/98
Tamara Sullivan, 3 Ennismore Dr, Keysborough	123.91	''	18/03/98
Susan Smart, 5 Warringah Crs, Eltham	229.40	''	06/05/99
F. Lowe & Co Pty Ltd, PO Box 337, Box Hill	231.60	''	31/05/99
Susan Margaret Hawker, 764 Warrigal Rd, Malvern East	120.00	''	25/11/97
Susan Rae Drakeford, Unit 54 108 Greville St, Prahran	144.00	''	23/04/98
John Desmond Delaney, 36 Kerry Rd, Ringwood North	226.30	''	15/02/99
Alicia C. Gonzanez, 5 Royena Ct, Warranwood	100.00	''	17/07/98
Benny Lonnborn, 6 Loch Street, Surrey Hills	105.25	''	08/06/99
Raymond Briggs, Flat 5, 488 Waterdale Rd, Heidelberg West	101.05	''	14/05/98
Matthew Evans, 63 Barkley Street, Armadale	205.00	''	23/11/98
Mohamed A. Abdullahi, Flat 2 354 Bell St, Heidelberg West	160.00	''	27/04/98
Ross Anderson, 8 Bank Street, Alphington	201.30	''	01/03/99
Michael Floriddia, 324 Toorak Rd, South Yarra	312.10	''	09/06/98
James Calvert-Jones, 3 Penny Lane, South Yarra	113.22	''	29/06/99
A. F. Guy, 23 Hill Street, Toorak	396.85	''	17/03/98
Amanda Faye Fletcher, Unit 1, 15 Elderslie Tce, Newtown	101.70	''	23/03/98
Spotlight Stores Pty Ltd, 100-110 Market Street, South Melbourne	128.31	''	15/07/98
Margaret Alison Hepworth, Unit 1, 301 Dandenong Rd, Prahran	124.90	''	08/06/99
Nicholas Prassinis, Ms Pty Ltd, 4 Bicentennial Close, Doncaster East	148.60	''	03/05/99
Roberto Bertini, 41 Elphin Street, Ivanhoe	614.00	''	23/03/98
Steven Chris Hateley, 12 Cypress Street, Stawell	257.50	''	04/06/98
Evan Davis Hopkins, 24 Lydia Mary Drive, Berwick	135.70	''	15/07/97

Better Grade Pty Ltd, Attn Mr Bill Giles, 354 Murray Street, Colac	110.10	''	09/03/99
Suzanne Kaye McCormack, 5 Tucker Rd, Clyde	235.75	''	22/08/97
Kelly Iriene Turner, 407 Myers St, East Geelong	126.95	''	24/06/99
Kilpara-Body Corporate 2025 Li, 35 Fletcher St, Essendon	170.55	''	09/07/97
L. A. Robertson, 5 Benbow Crs, Boronia	175.00	''	09/10/96
Mandy Wong, Unit 6, 8 Howard St, Box Hill	1,072.60	''	26/08/98
Omar Elsamad, Unit 2, 284 Dorcas St, South Melbourne	215.65	''	05/05/99
Kathy Johnston (Sole Trader), PO Box 413, Boronia	141.45	''	23/02/98
Lawrence James Trewartha, 285 Gelliondale Road, Alberton West	112.50	''	20/11/97
Peter Bajer, Unit 2, 136 Clayton Rd, Clayton North	145.65	''	21/09/98
Gregory Phillip Powell, PO Box 87, Winchelsea	106.55	''	28/10/98
Murphy John, 8 Burnbank Street, Ballarat	129.70	''	12/04/99
Robert Lance Porter, 1 Island Street, Clunes	215.65	''	29/04/99
Donna Maree Gannon, Post Office Heyfield, Heyfield	258.10	''	09/07/98
Nigel John Branson, PO Box 398, South Yarra	167.50	''	22/12/97
Carolyn Joy Hicks, 6 O'Connor Street, Horsham	251.50	''	16/11/98
William Phillips, 12 Callister Street, Shepparton	152.26	''	26/03/97
David Broomfield, T/a Murray St Veterinary Clinic, 330 Murray Street, Colac	310.70	''	13/10/98
Country Select Meats Pty Ltd, Shop 14, Archer & High Streets, Shepparton	182.55	''	24/06/99
Meilan Poon, 801 Orrong Rd, Toorak	552.45	''	30/06/97
Kaye Louise Denehey, 2A Evelyn St, Manifold Heights	148.00	''	31/03/98
Kerry Anne Belsar, 142 Mount Joy Pde, Lorne	273.50	''	10/07/97
Rhonda Jean Jackson, 5 Alvista Crt, Bannockburn	115.05	''	26/02/98
Gary Robert Acott, PO Box 459, Healesville	203.85	''	23/03/98
Isabelle Pearl Matthews, PO Box 368, Stawell	452.00	''	10/08/98
Tina Lin, Unit 10, 40 Harold Street, Hawthorn East	432.65	''	16/05/98
Conrad Francis Chiu, 12 Goulburn St, Box Hill North	110.75	''	19/06/97
Peter Anthony Phelan, 60 Station St, Rainbow	140.50	''	14/11/97
Desmond Gough, 43 Latrobe Street, Mentone	213.20	''	27/01/98
Eddie Berti, 10 Rosedale Gr, Ivanhoe	101.45	''	17/02/99
Longevity Institute of Australia Pty Ltd, 627 Chapel Street, South Yarra	114.75	''	08/02/99
Total Office Interiors Pty Ltd, PO Box 213, Boronia	1,299.70	''	08/10/98
Diane Lyn Close, Unit , 28 Sydney Street, Sunshine	100.00	''	07/08/97
Chris Walsham, 54 Ayr Street, Reservoir	173.35	''	29/08/97
C. Wilson, 15 The Glades, Hoppers Crossing	106.50	''	23/12/97
R. C. Davies, Lot 97, Caravan Dora, PO Box 576, Pakenham	139.00	''	13/05/99
John S. Chappell-Lawrence, Unit 4, 506 Dana St, Ballarat	105.10	''	19/05/99
M. S. R. and J. Molloy, 92 Lwr Heidelberg Rd, Ivanhoe	120.65	''	27/05/99
Geoffrey Hugh Campbell, T/a Geoff Campbell Design, 70 Monbulk Road, Kallista	129.30	''	15/06/99
Brokers G.W.S P/L/ T/a G.W.S. IOkers, Unit 2, 42 Castle Street, Eaglemont	359.45	''	11/06/97
Tanya Cartledge, 1214 Mair Street, Ballarat	116.55	''	18/11/97
Couta Jet Ski Hire, Mrs Suz Ski Hire, 382 Gilbert Road, Preston	144.46	''	10/04/97
R. Nanthakumar, Apesma:Equal Access Phone Plan, PO Box 1420, Traralgon	241.80	''	30/12/98

31 Marina Stavridies, T/a Memphis, 443 Chapel Street, South Yarra	375.85	''	27/08/98
Mr Geoffrey Swanton, 29 Fern Street, Inverloch	106.60	''	01/02/99
Blackwell Scientific Public, 54 University Street, Carlton	103.94	''	11/12/98
Mr J. F. Leidler, Continental Cakes, 96 Glenferrie Road, Malvern	303.90	''	15/09/97
Melbourne Ski Boat Marine Ltd, PO Box 3018, Eltham	102.80	''	19/11/97
Brad Ronald Hollingsworth, 9 Ti Tree Ave, Carrum	165.70	''	11/05/98
Wendy Suzanne McCormack, 34 Swanston St, Terang	125.60	''	18/05/98
Sharraock Plumbing Pl, 9 Cavanish Rd, Burwood	113.15	''	30/12/97
Myra Coffin, 7 Dorchester Ct, Frankston	270.40	''	17/03/98
Alistair Gordon Buttler, 6 Burberry Crt, Carrum Downs	248.50	''	04/08/98
Gippsland Environmental Services, Td 8, Ash Court, Traralgon	167.85	''	13/11/98
Ills General Store, Alan Franci, 7 Regency Pl, Doncaster	239.65	''	22/01/99
Dana P. Wong, C/o World Wing Chun Academy, 3rd Floorr, 96 Flinders Street, Melbourne	117.65	''	28/01/99
Nicole Varley, Unit 201, 14 Princes Street, Port Melbourne	386.85	''	30/01/98
Lynette Mullins, 47 Wunalla Rd, Seaford	110.00	''	17/10/96
Fady Lakkis, Shop 318, Level 3, 25 Main Street, Greensborough	259.25	''	26/06/96
Margaret Evelyn Douglas, Glas 4, Rasheda St, Watsonia	166.95	''	01/10/98
Matthew John Spain, C/o Northwest Funerals, PO Box 2000, Mildura	191.15	''	14/01/99
Self Adhesive Markings Pty Ltd, PO Box 244, Patterson Lakes	251.10	''	06/10/98
MCM Autos, Mick Conner, Factory 13, 3 Amayla Crs, Carrum Downs	128.20	''	14/01/99
Phillip Andrew Edwards, PO Box 230, North Melbourne	125.25	''	25/03/99
Angelo Gallo, PO Box 321, Mildura	184.60	''	09/03/99
LMT Australia P/L, 140 King Street, Melbourne	174.20	''	05/05/99
Dentsply (Australia) Pty Ltd, 204-206 Gipps Street, Abbotsford	120.85	''	20/11/97
Phillip Chochovski, 4 Barnhill Close, View Bank	123.90	''	06/04/99
Nursevil Kotaman, 146 Cox Road, Corio	137.65	''	15/03/99
Hooker Cockram Ltd, 246-260 Bourke St, Melbourne	144.55	''	23/09/98
Noel Grech, Unit 1, 79 Maribyrnong Rd, Ascot Vale	175.15	''	20/04/99
Timberland Inscape Pty Ltd, Ta Unit 1, 459 Little Collin Street, Melbourne	874.00	''	19/05/99
V. M. Wakefield, PO Box 141, Chelsea	300.00	''	27/04/99
Tony Smith Onramp Testing, Level 16, 242 Exhibition Street, Melbourne	810.03	''	28/09/98
Gardener Brook, GPO Box 4674TT, Melbourne	107.85	''	20/05/99
Nick Vrettas, Shop 29, 331 Bourke Street, Melbourne	123.00	''	08/04/99
Tyrone Alicx Cerminara, 2 Carrington St, Edithvale	161.00	''	10/06/99
Jannes House Of Fashion Pty Ltd, Shop 1, 190 Belmore Road, Balwyn	104.15	''	02/10/98
Global Immigrations Pty Ltd, Level 1, 141 Osborne Street, South Yarra	330.00	''	16/09/97
Mr J. Mck Droomer, Lot 2A Sayers Rd, Werribee	133.55	''	16/06/99
Maureen Ceciele Shields, 79 Pearson St, Bairnsdale	170.00	''	21/07/98
N. L. Preston, Unit 5, 240 Wade Ave, Mildura	123.20	''	25/01/99
Stephen Roy Jones, Unit 1, 28 Whatley St, Carrum	219.65	''	30/12/98

Dennis Kingshott, 14 Denver Ct, Meadow Heights	178.50	''	05/08/98
Andale Engineering, 55 King Street, Airport West	125.55	''	24/05/99
Community Services & Health Tr, PO Box 608 A'Beckett Street PO, Melbourne	112.35	''	11/06/99
Tony Smith, Onramp & Vtr Testing, Level 16, 242 Exhibition Street, Melbourne	1,908.95	''	04/12/98
Patrick Fahey, Oliver Davey, Level 3, 3 Bowen Crs, Melbourne	143.80	''	18/05/98
Richard James Elton, 6 Church Street, Beaumaris	115.30	''	20/07/98
Stephen Johnson, Flat 14, 22 Agnes St, East Melbourne	159.99	''	21/10/98
Malcolm Ian Burnside, 531 Hampton Street, Hampton	216.45	''	12/03/99
Gordon Lane, Unit 3, 5 Hall Street, Cheltenham	312.10	''	31/08/98
Fiona Gaie Curnuck, 54A Rennie Street, Thornbury	100.10	''	02/02/99
Nevzat Arslan, 16 Bakery Street, Brunswick	141.00	''	07/08/97
Morena Bates, 2 Sturt Street, Ballarat	146.00	''	19/11/98
Malcolm Paterson, Lot 21, Viewgrand Way, Greensborough	113.07	''	04/02/99
April Ellis, 59 James Cook Drive, Diamond Creek	150.00	''	24/10/97
Cengiz Osman, Woodville Park, Shop 4, Waringa Crs, Hoppers Crossing	100.00	''	27/04/98
Dale Chesson, 182 Nepean Highway, Seaford	227.25	''	17/01/97
Tim O'Neill, Level 4, 190 Bourke Street, Melbourne	153.80	''	07/06/99
Ronnie Nurmawun, 3E Lonsdale Street, Melbourne	192.50	''	27/08/98
Andrew Stuart, Unit 12, 9 Beach Street, Port Melbourne	115.10	''	07/01/98
Zhimin Shi, 476 A. Hotham Rd, Caulfield South	114.20	''	05/03/99
Teong Chuah, Unit 3G, 181 Exhibition St, Melbourne	192.85	''	13/02/98
Poba Govanc, 5 Sturt Crt, Cranbourne North	163.60	''	16/12/98
M. M. Lord, 31 Santa Barbara Drv, Frankston	107.45	''	21/12/98
Laurette Brigitte Smallman, PO Box 47, Cheltenham	158.90	''	06/04/98
Michelle Ann Jenkins, 163 Spencely St, Clifton Hill	136.50	''	02/03/99
Peter Reid, Unit 3, 1 Allard Street, Brunswick West	124.05	''	24/09/96
Hamid Abbasi, Unit 1, 24 Cohuna St, Brunswick West	227.20	''	29/04/99
The Manager Pat Fruitland Lama, Shop 118, 1239 Nepean Highway, Cheltenham	102.76	''	12/03/99
Micheal Kenneth Selby, 15 Yvonne St, Croydon South	122.35	''	21/06/99
Dianne Maree Robinson, 6 Echo Ct, Kialla	115.00	''	16/03/99
Happy Tots Pty Ltd, (Administrators Account), 100 Partridge Way, Mooroolbark	142.67	''	18/12/98
Ivonne Lizama, 165 Hall Rd, Carrum Downs	125.00	''	27/11/96
Envec Pty Ltd, PO Box 50, Berwick	104.40	''	13/05/98
Michael Kenneth Wood, 2 Gladstone St, Sandringham	290.65	''	13/11/98
Andrew Allan Leggit, State Trustees, 168 Exhibition Street, Melbourne	758.40	''	21/01/99
William F. Bertram, T/a Mentone Aquariums, 137 Nepean Hwy, Parkdale	241.10	''	05/01/99
Equal Access Pty Ltd Eq, Unit 6, 454 Collins St, Melbourne	158.15	''	28/08/97
Design Technologies Pty Ltd, Suite 3, 85 Bardia Avenue, Seaford	422.05	''	07/08/97
Mr Peter Furborough, T/a Golf Way Agencies, Factory 1, 26 Shearson Crs, Mentone	180.50	''	13/01/99
Denacom Security Pty Ltd, Liquidator Apptd Pre Debt, PO Box 781, Dandenong	136.99	''	01/05/99
Children For Christ, PO Box 5012, Cheltenham East	100.00	''	24/10/97

Lynette O'Connor, 10 Sandy Street, Nunawading	111.00	''	15/12/97
Debbie Anne Woods, C/o St Andrews Post Office, St Andrews	279.90	''	19/03/98
Oliver Hume Real Estate Pl, Ground Floor South, 1 St Kilda Road, St Kilda	152.00	''	01/04/99
Aust Wide Communications P/L, 20 Lacenet Street, Frankston North	632.45	''	03/05/99
Joseph Vuillemain, 8 Whitton Gr, Werribee	103.80	''	11/05/99
Mark Roy Faust, 76 Rose Street, Coburg West	174.25	''	14/10/97
Daniel Dubois, Flat 3, 117 Victoria St, Brunswick East	145.15	''	17/12/96
A. M. Reynolds, Rear 22, Norval Crs, Coolaroo	176.55	''	13/11/97
Lynette Dawn McCullagh, 36 John St, Mildura	139.00	''	05/02/99
Aluminium Industries Aust Pl, 17 Taylor St, Moorabbin	195.90	''	23/01/97
Rebekah Simpson, Att Rick Verhage, C/o ANZ Bank 4:100 Queen Street, Melbourne	185.75	''	10/09/97
Robyn Hardie, 33 Fernside Ave, Briar Hill	128.75	''	03/12/98
D. Beck, Unit 1, 1383 Nepean Hwy, Cheltenham	152.70	''	18/02/99
Dianne Mobbs, Unit 25, 22 Agnes St, East Melbourne	105.30	''	17/05/99
Peregrine Adentures Pty Ltd, Ventures, 258 Lonsdale Street, Melbourne	147.60	''	21/05/99
R. R. Dunn, 20 The Boulevard, Whalers Cove, Patterson Lakes	102.11	''	27/05/96
Carlo Bova, C/o Georgia Haloulos, Locked Bag 5729, Melbourne	111.85	''	05/02/99
Susan Hayes, 33 Mcmurtry Way, Frankston	108.70	''	26/10/98
Jeremy Fleming, PO Box 134, Sale	147.55	''	18/11/98
Steven John Rebbechi, Rmb 2825 Sutcliffes Rd, Numurkah	112.25	''	08/09/97
Melanie Jane Gaylard, Unit 6, 9 Daly St, Brunswick West	140.60	''	11/03/99
Brett James Dargue, 14 Kayden St, Cheltenham	105.84	''	18/11/98
David Ferris, 34 Hawker Street, Ivanhoe	105.60	''	09/02/98
Elvie Monica Doherty, Unit 1, 244 Station St, Edithvale	180.00	''	21/01/99
Lafontine Raymond, Ns Team 7, PO Box 955, Dandenong	400.00	''	29/01/98
Sharon Scott, 18 Parkview Tce, Lysterfield	184.35	''	11/11/98
Kate Thompson, 11A Westbourne St, Brunswick	119.85	''	21/05/98
Mary Smith-Frowd, 170 Graham St, Broadmeadows	106.10	''	24/12/97
Advanced Trade International, PO Box 4356, Glen Waverley	628.40	''	02/07/97
Kathy Reed, 86 Aquarius Drv, Frankston	109.20	''	26/11/98
Activair Australia Pty Ltd, PO Box 1084, Tullamarine	352.50	''	13/11/98
Shane Jason Thomas, 56A Hothlyn Dr, Craigieburn	110.00	''	17/03/99
Howard Bruton, 14 Gleniffer Ave, Brighton East	116.80	''	15/05/98
Mr Ron Pedder, T/a: Ninth Nibbles, PO Box 641, Mildura	157.50	''	24/09/97
Jennifer Robyn Campbell-Hirst, PO Box 147, Bruthen	108.10	''	21/05/99
Mascoma Pty Ltd, PO Box 2174, Mt Waverley	202.00	''	13/11/98
Isuzu: Gm Isuzu: Gm Account, P.O. Box 223, Mulgrave North	920.15	''	19/04/93
Janice O'Donohue, 24 Florence Street, Cheltenham	179.90	''	09/04/98
Lorna Cendamo, 6 Redfern Crs, Mulgrave	257.45	''	19/05/98
Rick Gerrard Both, P.O Box 55, Traralgon	3119.75	''	23/01/98
Murray Valley Electrics P/L, 35 Pine Ave, Mildura	135.05	''	11/12/98
Mr Doug Elford, T/a Supa Ware Distributors, PO Box 1772, Ballarat Mail Cntr, Ballarat	146.20	''	19/01/99
Adam John Cartwright, 62 Elgin Street, Myrtleford	109.00	''	21/05/98

Community Services Doveton, Hal. Community Housing Service, 67 Power Rd, Doveton	129.30	''	03/02/99
Mr H. G. Searle, Box 3027, Mildura	112.80	''	08/02/99
Jatech International Pty Ltd, PO Box 613, Noble Park	141.45	''	19/05/98
The Cheesecake Shop Pty Ltd, The Cheese Cake Shop Ballarat, 1213 Sturt St, Ballarat	135.95	''	11/01/99
Mr B. M. Brumley, 5 Heard Street, Mortlake	180.55	''	08/08/97
Andre Day, T/a Life In Verse, PO Box 2774, Mildura Private Boxes	109.30	''	21/06/99
Trisha Withers Melbourne Doll, 91 Addison Street,, Elwood	131.15	''	30/03/99
Timberland Pty Ltd, PO Box 194, Market Street, Melbourne	136.90	''	05/05/99
J. L. Whittle, C/o S Garrett, PO Box 955, Dandenong	114.13	''	03/07/98
Section Oaks B'meadows Bingo, 495 Pascoe Vale Road, Strathmore	1,100.00	''	23/11/98
Janet Tune, 8 Oberon Drv, Carrum Downs	100.00	''	19/05/98
Mary Avril Sweeney, 21 Witternberg Ave, Frankston	119.60	''	26/11/98
Janene Bowden Pty Ltd, 167 Thames Promenade, Chelsea Heights	122.95	''	24/06/99
Klepners Jewellers P/L, 324 Little Collins St, Melbourne	405.05	''	14/12/98
Elizabeth Anne Larkin, Flat 2, 78 Woodville Park Dve, Hoppers Crossing	156.50	''	08/01/97
Business Operations and Software Solutions Pty Ltd, 40 Hooker Road, Werribee	120.10	''	16/03/98
N. J. S. Technology, 2/14 Miles Street, Mulgrave	160.70	''	09/05/97
Kelly Leanne Milne, 1A Esplanade Ave, Brighton Beach	159.65	''	12/10/98
Peter McKee, 16 Vincent Crs, Werribee	219.75	''	17/03/98
Keith Percival Rhyne, Rm 20, 5A Liege Ave, Noble Park	209.79	''	23/12/97
Acson Computer Supplies Pty Ltd, 43-51 Rupert Street, Collingwood	105.10	''	15/02/99
Mustafa Elbodon, 10 Antwerp Drive, Keilor Downs	150.00	''	24/09/98
Baby Health Centre Charman Rd, Attn Peter, City of Kingston, PO Box 1000, Mentone	189.84	''	12/01/99
Margaret Carpinteri, 4 Drovers La, Somerville	139.40	''	03/11/97
Homotech Industries Pty Ltd, Lot 3, The Parkway Nr, Patterson Lakes	102.90	''	10/12/98
Samantha Lee Hadenfeldt, Unit 1 12 Plantation St, Mildura	230.00	''	09/04/98
Travis John Probert, Unit 9, 843 15th St, Mildura	207.94	''	25/07/97
Kylie Adine McNeill, RSD 1467, Ararat Rd, Crowlands	300.00	''	27/03/98
Mark Lero Kelava, C/o Unit 2, 11 Rowe St, Ballarat	180.70	''	02/03/99
Kerrie Rose, 500 City Rd, South Melbourne	111.57	''	24/12/96
Marie May Benfield, Unit 1 142 Orange Ave, Mildura	138.65	''	29/12/98
Courier 91 Pty Ltd, 4 Lenne Rd, Beaconsfield Upper	119.65	''	13/11/98
Glenn Michael Daldy, 63 Patterson Rd, Shepparton	107.15	''	22/10/97
Suzie Kalaitzis, 47 McGregor St, Malvern East	242.45	''	01/04/99
Andrew Zurcas, PO Box 460, Shepparton	135.40	''	05/08/98
Trenton John Symons, 190 St Kilda Rd, St Kilda	200.00	''	30/10/96
Stephen Pianko, 961 Glenhuntly Rd, Caulfield South	101.90	''	20/10/98
Earle Bloomfield, 3 Yambra St, Clifton Hill	146.95	''	29/04/99
Timothy Girdwood, RSD 1632, Kerang	165.00	''	09/06/98
Ventre Joseph, 4a Mookarii Street, Cobram	105.05	''	08/12/98
Andrew John Dowling, 11 Maria Crt, Cranbourne North	235.05	''	03/02/99
Ella Isabell Lawrence, Unit 11, 58 ClarendonStreet, East Melbourne	122.90	''	11/11/97

John Farrington, 117 Gavan Street, Bright	140.60	''	07/05/99
Internaional Giftware Imports, 53 Cochranes Road, Moorabbin	185.00	''	10/10/98
Sam Marvilla, 51 Riley Street, Wangaratta	452.10	''	03/02/99
Hugh Stewart, C/o SKF Australia Pty Ltd, PO Box 301, Oakleigh	122.55	''	21/01/98
Hien In Chung, 10 Emily Street, Seymour	144.00	''	14/04/98
Mrs Higginbottom, C-o Carol Barlow, Locked Bag 10, Ivanhoe	207.00	''	16/09/97
The Principal Cranbourne High School, PO Box 27, Cranbourne	599.75	''	17/11/98
Ria Jacoba, PO Box 6273, Shepparton,	141.75	''	17/05/99
Li Richard, 24 Wills Street, Wangaratta	104.95	''	05/11/98
Rosemary Ann Bangs, 12 Albatros Crt, Blind Bight	146.55	''	31/12/97
V. Christie, 43 Halpin Cres, Shepparton	160.00	''	27/05/98
Milka Angelovski, 39 Regal Ave, Thomastown	263.45	''	07/04/99
Abhaya Pty Ltd, 530 Malvern Rd, Prahran	128.70	''	07/12/98
Mt Martha Health Care P/L, PO Box 512, Flemington	455.55	''	02/10/97
Sascha Andonas, 5 Gertrude Street, Windsor	121.75	''	08/01/99
Poppy Industries Pty Ltd, Recvr Mngrs Account Final, PO Box 290, Collins Street West, Melbourne	149.98	''	17/02/99
Rita Bentley, 75 Darling Rd, Malvern East	102.40	''	04/05/99
Racamans Refridgement Transprt, Stewarts Hotel, 175 Elgin Street, Carlton	119.00	''	03/06/99
Becky Ann Smith, PO Box 20, 393 Wattle Tree Rd, Malvern East	135.69	''	28/04/99
Edgley International Pty Ltd, Attn Greg Hall, PO Box 4500, East Richmond	364.85	''	28/08/98
Prahran Dairy P/L, 74 Hornby Street, Windsor	105.00	''	26/01/99
Nola Jean Hall, 19 Driscolls Rd, Kealba	136.85	''	17/03/99
Michael Dean, 21 Gunsynd Ct, Keilor Downs	142.95	''	24/06/99
Steve Ostwald (Sole Trader), Suite 22, 284 Dorcas Street, South Melbourne	220.10	''	20/10/98
Phillip Camilleri, 9 Raleigh St, Spotswood	128.00	''	16/12/98
Proche Pty Ltd, PO Box 820, Echuca	128.80	''	19/12/98
Lakemont Haven Pty Ltd, Floor 1, 521 Toorak Rd, Toorak	139.85	''	28/06/99
Marc Colman, 1 Fisher Street, Maidstone	243.75	''	09/10/98
Graeme Boyd, 21 Joes Gully Rd, Eaglehawk	194.05	''	22/08/97
Gavin Charles Downes, Unit 2, 3A Burke Rd, Malvern East	200.00	''	26/03/98
Jennifer Roberts, Attn Fiona, GP 9, PO Box 955, Dandenong	104.17	''	04/03/99
Giulio Demaria, 548 Drummond St, Carlton North	163.70	''	05/10/98
Southern Directions Youth Services, 54 Rosstown Rd, Carnegie	118.15	''	05/05/98
Kellie McMahon, 8 Reginald Crt, Wangaratta	100.00	''	04/06/99
Jewellery Chain, T/a Kleins 1 Abbots Rd, Dandenong	234.25	''	18/03/97
G. R. Dempster, PO Box 27, Koo Wee Rup	186.75	''	09/05/97
R. Penn, 78 Hume Street, Echuca	103.20	''	22/07/97
Peake Elaine (For Aust Reading), Floor 1, 185 Lygon Street, Carlton	103.00	''	23/06/99
Safety First Pty Ltd, 251 Hyde St, Yarraville	100.70	''	06/10/98
Nguyet Thi Thu Nguyen, 21 Grantham St, St Albans	123.65	''	07/08/97

Lenny Bruinse, T/a Carlton Radiator Services, 207 Dryburgh Street, North Melbourne	106.15	''	19/12/97
Bibiana Flores, 20 Kingsmead Cl, St Albans	959.97	''	20/04/98
Albert Trihey, Flat 1, 55 Filbert St, Caulfield South	180.95	''	29/01/98
Sally James, Mission 115 Droop Street, Footscray	372.70	''	30/08/96
Paul Lawrence Weight, 38 Autumn Crs, Mt Eliza	122.95	''	13/11/96
Paul Volkering, RSD 2, Yeovil Ct, Wheelers Hill	165.00	''	21/09/98
Akiko Ochiai, Unit 12, 34-50 Neill Street, Carlton	542.16	''	21/07/97
Melanie Dimattina, 203 Canning Street, Carlton	450.00	''	26/02/97
Julian Peter Laws, 116 Peel Street, Windsor	104.60	''	25/07/97
Alex Ernest King, PO Box 1072, Tullamarine	220.20	''	28/05/98
J. Holden, C/o 46 James Street, Pakenham	107.30	''	25/03/97
Thomas Hoy, PO Box 251, Bright	111.23	''	11/12/98
St Kilda Beach House Pty Ltd, 59A Newmans Road, Templestowe	142.60	''	14/11/97
Atsushi Matsuba, Flat 12, 43 Raleigh Street, Prahran	363.40	''	01/04/97
G. R. McPherson, PO Box 204, Shepparton	314.80	''	07/06/99
Ms Deborah Brown, T/a Tinker's, PO Box 434, Mornington	296.00	''	11/12/97
Mr P. C. Golombek, 47 Donald St, Prahran	149.45	''	21/12/98
Phuong D. Tran, 31 Sydney Rd, Coburg	102.40	''	04/12/98
Video Ezy Camelot Place Pty, T/a Video Ezy, 270 Settlement Road, Thomastown	131.86	''	21/05/99
Mornington House Euroscan Pty, T/a Mornington House, 2 Romney Avenue, Tootgarook	108.80	''	22/06/98
Danielle Yvette F. Enior, 42 Northleigh Ave, Craigieburn	137.95	''	13/11/98
Mr F. Filippone, Mornington Latent Images, 1150 Nepean Hwy, Mornington	104.45	''	13/01/98
Mr Roger Ledy Cake Shop, 192 Commercial Rd, Prahran	114.00	''	19/01/99
Giennie Tucker, 30 Earlston Circuit, Cranbourne	100.00	''	28/11/97
Taylor Made Prints Wayne & Tedty Ltd, T/a Taylor Made Prints, 41 Wood Street, Mandy Knight, Novation Leasing Company, Level 2, 479 St Kilda Road, Melbourne	137.25	''	09/06/99
Santina Di Natale, 26 Douglas Ave, Chelsea	154.70	''	19/05/99
N. G. Rogers, 8 Heather Ave, Pascoe Vale	112.20	''	22/05/99
Julie Maree Pappin, PO Box 175, Rochester	145.90	''	01/06/99
Debra Frances Parkinson, 36 Vernon Rd, Wangaratta	184.50	''	08/04/99
Andrew David Collins, 8 Stoneycreek Rd, Beaconsfield Upper	127.15	''	09/02/99
Sandy Traikovski, 10 Beaconsfield Pde, Northcote	126.55	''	31/10/97
McDonald John, 24 Webster Street, Alexandra	122.65	''	29/01/99
Gregory John Price, 59 Berrys Beach Rd, Ventnor	237.20	''	10/02/99
Malcolm John Cribbes, PO Box 122, Yarra Glen	129.75	''	11/05/99
Richard William Olney, 81 Creswell St, Crib Point	180.70	''	03/03/99
Peter Fulton, Suite 7 62a Young St Frankston	278.00	''	31/07/97
Dalal Smily, PO Box 530, Bayswater	131.77	''	26/04/99
Andrew Turner, 220 Larcombes Rd, Modewarre	320.45	''	12/11/98
Mark Francis Villella, 43 Brook Street, Hawthorn	271.87	''	08/06/99
Morrie Berrell, PO Box 7203, Karingal	122.40	''	26/05/99
Jumbahadur Gurung, 280 Sydney Road, Coburg	250.00	''	22/04/99
Alan James Buck, Valley Farm Rd, Healesville	205.00	''	14/10/98
Planet Internet Pty Ltd, 32 Glenferrie Rd, Malvern	179.55	''	05/05/98
Benadette Elinelech Linton, 15-17 Railway Avenue, Huntingdale	138.15	''	12/03/99
	100.60	''	12/01/99

Mr Peter Ferrett, J. Campbell-Ewp, Locked Bag 27, Box Hill	200.00	”	20/04/99
Randolfo Obregon, 14 Amelia Street, Wheelers Hill	100.00	”	23/10/97
Malcolm P. Stone, 107 Lorimers Lane, Dixons Creek	117.90	”	13/05/97
Astra Chauffeured Limonsines Pty Ltd, 184 Sydney Road, Coburg	128.91	”	01/03/99
Mr R. Tulshyan, Unit 3 14 Anderson St, Caulfield South	1,767.89	”	01/07/97
A. Paoli, 5 Burbridge Drv, Greenvale Matthew James Street, T/a Pro-Street Automotive, Factory 2, 6 Kitson Street, Frankston	123.75	”	23/04/99
Julie May Davidson, 1 Eric Crt, Oakleigh South	130.80	”	09/03/99
Vicki Deutsher, 7 Tibbles Street, Beaumaris	100.00	”	27/01/99
Katerina Tetera, Shop 2, 387 Glenhuntly Rd, Glen Huntly,	100.00	”	18/05/99
D. Sanicki, PO Box 5, Carlton South	129.95	”	11/05/99
Crestron Australia P/L, 1st Floor, 605 Keilor Road, Niddrie	243.20	”	15/11/96
	115.12	”	15/12/98

02147

CONTACT: TELSTRA CORPORATION LIMITED, PHONE: 1800 227 869

Unclaimed Moneys Act 1962

Register of Unclaimed Moneys held by the —

<i>Name of Owner on Books and Last Known Address</i>	<i>Total Amount Due to Owner</i>	<i>Description Of Unclaimed Money</i>	<i>Date when Amount first became Payable</i>
TELSTRA CORPORATION LIMITED – DIVIDENDS			
	\$		
A. & S. Torre Pty Ltd, PO Box 2085, Malaga, WA	130.00	Cheque	27/10/00
A. C. Engineers Pty Ltd, "Andromeda Account", C/- 1 Dulcie Street, Dulwich, SA	275.20	"	28/04/00
A. J. B. Investments Pty Ltd, 11 Richmond Court, Castle Hill, NSW	360.00	"	27/10/00
"Mishan Dahi A/C", PO Box 239, Box Hill	100.00	"	"
"Marvel Engineering S/F A/c", Unit 2, 20 Clearview Place, Brookvale, NSW	148.00		"
Abbef Pty Ltd "Abbeff P/L Employees S/F A/C" 386 Scarborough Beach Road, Innaloo, WA	150.00	"	"
Raymond Joff Abbott & Colleen Ann Ford, Loen 235, Abbott's Road, Coolup, WA	100.00	"	"
Raymond Joff Abbott, "Mariah Abbott Account", Post Office, Coolup, WA	100.00	"	"
Louise Anne Abbott, "Zoe A/c", 174 Park Road, Dundas, NSW	100.00	"	"
Mrs Ravinder Abbott, 58/81B Gerard St, Cremorne, NSW	100.00	"	"
Mansjur Abdat, 13 Greenview Road, Narara, NSW	100.00	"	"
Rozita Abdul-Rahman, 5 Desailly Crescent, Kambah, ACT	151.00	"	28/04/00
Rozita Abdul-Rahman, 5 Desailly Crescent, Kambah, ACT	250.00	"	27/10/00
Maxwell Charles Abrahams & Beverley Ann Abrahams, 23 Markham Avenue, Runaway Bay, Qld	100.00	"	"
Adrian Clive Abrams, 57 Woodland Street, Balgowlah Heights, NSW	120.00	"	"
Lea Acance, 10 Crofton Drive, Williamstown	100.00	"	"
ACC Serve Pty Ltd & Supportive Care Services Pty Ltd, PO Box 9063, Scoresby	160.00	"	28/04/00
ACC Serve Pty Ltd & Supportive Care Services Pty Ltd, PO Box 9063, Scoresby	200.00	"	27/10/00
Steve Accardo, 342 Morland Road, West Brunswick	100.00	"	"
Lubco Acevski, 8 Lacy Street, Avondale Heights	100.00	"	"
ACN 068907497 Pty Ltd, "DPA Super Fund A/c", Level 10/123 Lonsdale Street, Melbourne	152.00	"	28/04/00
ACN 068907497 Pty Ltd, "DPA Super Fund A/c", Level 10/123 Lonsdale Street, Melbourne	190.00	"	27/10/00
ACN 079 481 744 Pty Ltd, "ACN 079 481 744 S/Fund A/c", C/- William Beerworth, Level 10, 1 Alfred Street, Sydney, NSW	241.45	"	28/04/00
Acorn Consolidated Pty Ltd, "The Clam Account", 47 South Perth Esplanade, South Perth, WA	1,012.75	"	"

Anthony Mark Adamo & Deborah Anne McCombe, 1065 Riversdale Road, Surrey Hills	100.00	''	27/10/00
Brett Robert Adams, 225 Konagaderra Rd, Oaklands Junction	128.00	''	28/04/00
John Adams, Kooba Street, Rand, NSW	192.00	''	27/10/00
Mr Selwyn Ashcroft Adams & Mrs Jeanette Mary Adams, C/- Stewart Adams, Ssb L16 Grosvenor Place, 25 George Street, Sydney, NSW	482.35	''	28/04/00
Adelphi Business System Pty Ltd, 22 Goegan St, Werribee	181.30	''	''
Adelphi Business System Pty Ltd, 22 Goegan St, Werribee	300.00	''	27/10/00
ADG Technology Pty Ltd, Po Box 425, Belmont, WA	100.00	''	''
Paul Adler, 334 Bambra Road, Caulfield South	146.00	''	''
Victor Nicholas Adrian, 285 Wollongong Surf Leis, Fairy Meadow, NSW	100.00	''	''
Advent Pacific Pty Ltd, "The Barnaby Powys Invest A/c", PO Box 591, Kingsford, NSW	460.00	''	''
Advertising Gallery Pty Ltd, "Advertising Gallery S/F A/c", C/- Tasker & Co, 250 Flinders Street, Adelaide, SA	132.85	''	28/04/00
Javed Ahmed, 1/28 White Avenue, Bankstown, NSW	140.00	''	27/10/00
Helen Ahmed, 211 Dryburgh Street, North Melbourne	140.00	''	''
Aigion Pty Ltd, 104 Wright Street, Middle Park	460.00	''	''
James Ainsworth, Po Box 770, Mount Isa, Qld	140.00	''	''
Mr Alister Charles Air, Unit 1, 146 Pitt Street, Redfern, NSW	100.00	''	''
Airbarb Pty Ltd, PO Box 752, Robina, Qld	129.00	''	28/04/00
Airbarb Pty Ltd, PO Box 752, Robina, Qld	214.00	''	27/10/00
Brian Charles Aitchison & Kerry Elizabeth Aitchison, 7 Whitehead Street, Corowa, NSW	150.00	''	''
Kevin George Aitken, 138A Glen Iris Road, Glen Iris	150.00	''	27/10/00
Elsie Gwenneth Aitken, 61 Salisbury St, Inglewood, WA	160.00	''	28/04/00
Lee Aitken, 55 Fortescue Avenue, Newman, WA	248.00	''	''
Lee Aitken, 55 Fortescue Avenue, Newman, WA	310.00	''	27/10/00
Loula Aitken & Ian Kenneth Aitken, 22 Austral Terrace, Malvern, SA	100.00	''	''
Noor Mohammad Akbar, 11 Simmonds Place, Endeavour Hills	100.00	''	''
Carmel Phyllis Albanese & Domenic Jason Albanese & Charles Damien Albanese, Po Box 550, Robinvale	120.70	''	28/04/00
Andrew Albert, PO Box 33, Garfield	160.00	''	''
Maximilian F. W. Albrecht, 5 Belah Gardens, Vacluse, NSW	100.00	''	27/10/00
Mr Darren Peter Alderson, 11A Ewan Street, Coburg	100.00	''	''
David Alderson, C/- P. Alderson, Level 18, 20 Bono Street, Sydney, NSW	200.00	''	28/04/00
David Alderson, C/- P. Alderson, Level 18, 20 Bono Street, Sydney, NSW	250.00	''	27/10/00
Aldorn Pty Ltd "A. D. Moloney Super Fund A/c", 71 McCarthy Street, Bundaberg, Qld	340.80	''	28/04/00
Aldorn Pty Ltd, "A. D. Moloney Super Fund A/c", 71 McCarthy Street, Bundaberg, Qld	426.00	''	27/10/00
Aldorn Pty Ltd, "Alan Moloney Super Fund A/c", 71 McCarthy Street, Bundaberg, Qld	181.30	''	28/04/00
Aldorn Pty Ltd, "Alan Moloney Super Fund A/c", 71 Mccarthy Street, Bundaberg, Qld	300.00	''	27/10/00

Ariella Alexander, 94 Perry Drive, Chapman, ACT	100.00	''	''
Malcolm David Alexander, "Yulp Pty Ltd A/c", 4 Ida Court, Vermont	100.00	''	''
Pask Alexis & Anna Alexis, 7 Amber Court, Pascoe Vale	100.00	''	''
Alexius Nominees Pty Ltd, "Barile Super Fund A/c", 74 St Helier Drive, Sorrento, WA	175.00	''	''
Mr Zamir Alfie, 1/1 Salisbury Street, Caulfield	120.00	''	''
Ronaldo Lenon Alfonso, 11/9 Rockley Road, South Yarra	280.00	''	''
Stephen J. Alford, 21 Gladesville Drive, Kilsyth	152.00	''	28/04/00
Stephen J. Alford, 21 Gladesville Drive, Kilsyth	190.00	''	27/10/00
Alice Springs Camera Shop Pty Ltd, PO Box 412, Alice Springs, NT	280.00	''	''
All Metal Roofing Pty Ltd, 39 Sydenham Road, Brookvale, NSW	603.10	''	28/04/00
Niklaas Allain, 45 Geraldine St, Bassendeen, WA	149.70	''	27/10/00
Mark G. Allan, 618 Victoria Road, Ermington, NSW	110.00	''	''
Deborah Karen Allen, 11 Kempston Court, North Croydon	100.00	''	''
Elizabeth Anne Allen & Keith Frederick Allen & Meredith Jane Alle, 53 Goldsmith Avenue, North Ringwood	100.00	''	''
Brett David Allen, PO Box 200, Cherrybrook, NSW	200.00	''	''
Mr Robert John Allen, "The Bob Allen S/Fund A/c", 4 Maloney Street, Kensington	100.00	''	27/10/00
Kenneth D. Allen, PO Box 118, Tuart Hill, WA	283.35	''	28/04/00
Mr Paul Charles Allen, Level 9, 213 Miller Street, North Sydney, NSW	241.45	''	''
Allender Enterprises Pty Ltd, 107A Neville St, Middle Park	100.00	''	27/10/00
Timothy John Allerton, 12A Tivoli Street, Mosman, NSW	120.70	''	28/04/00
Christopher Allingham & Catherine Allingham, Fletcher Vale, Charters Towers, Qld	167.60	''	''
Christopher Allingham & Catherine Allingham, Fletcher Vale, Charters Towers, Qld	278.00	''	27/10/00
Gail Ann Allison & Geoffrey Alan Baker, 14/199 Noble Street, Newtown	100.00	''	''
Alltric Pty Ltd "Rogers Family A/c", 36 Green Street, Spalding, WA	128.00	''	28/04/00
Alltric Pty Ltd, "Rogers Family A/c", 36 Green Street, Spalding, WA	160.00	''	27/10/00
Fernando Aloe, 1 Doyles Road, Shepparton	100.00	''	''
Carmel Aloe, 1 Doyles Road, Shepparton	100.00	''	''
Aloe Family Pty Ltd "Aloe S Fund A/c", 1 Doyles Road, Shepparton	100.00	''	''
Peter Maurice Alter, C/- BMFInvestment Services PL, Level 53, MLC Centre, 19 Martin Place, Sydney, NSW	164.00	''	''
Jessica Leigh Alter, C/- BMF Investment Services PL, Level 53, MLC Centre, 19 Martin Place, Sydney, NSW	164.00	''	''
Corrine Lynne Rosemary Alter, C/- BMF Investment Services PL, Level 53 MLC Centre, 19 Martin Place, Sydney, NSW	164.00	''	''
Mr Peter Alter, Level 12, 15 Castlereagh St, Sydney, NSW	200.00	''	''
Mr Richard Anthony Amato, Unit 4, 27 Mangerton Road, Wollongong, NSW	100.00	''	''
Megan Elizabeth Ambler, 97 Woodland Street, Balgowlah, NSW	100.00	''	''

Alan Ambrose, 31 Addison Street, Elwood	176.00	''	28/04/00
Alan Ambrose, 31 Addison Street, Elwood	220.00	''	27/10/00
Roger Ambrosino, PO Box 328, Leederville, WA	112.00	''	28/04/00
Roger Ambrosino, PO Box 328, Leederville, WA	140.00	''	27/10/00
Vivienne Amery & Peter Smooker, 144 Mooltan Street, Ascot Vale	100.00	''	''
Manubhai Amin, 130 Peachey Road, Davoren Park, SA	100.00	''	''
Dr Bhupendra Kumar Manubhai Amin, 130 Peachey Road, Davoren Park, SA	100.00	''	''
Anastacia's Creations Pty Ltd, PO Box A1457, Sydney South, NSW	200.00	''	''
Mr Nicholas Anthony Ancona, 35 Kingsway, Kingsgrove, NSW	160.00	''	28/04/00
Mr Nicholas Anthony Ancona, 35 Kingsway, Kingsgrove, NSW	200.00	''	27/10/00
Mrs Rosemary June Andersen & Mr Grant Damian Andersen & Mr Mark Patrick Andersen			
"Andersen Family Account", 83A Central Rd, Avalon, NSW	301.55	''	28/04/00
Andersen Communications Pty Ltd, PO Box 265, Kedron, Qld	100.00	''	27/10/00
Ken Anderson, 8/33 Oxlade Drive, New Farm, Qld	336.00	''	28/04/00
Sandra Anderson, 5/3 193 Domain Road, South Yarra	120.00	''	''
Tom Anderson, 4 Macrobertson Cl, Fitzroy	120.70	''	''
Tom Anderson, 4 Macrobertson Cl, Fitzroy	200.00	''	27/10/00
Mrs Heather Josephine Anderson, 47 Mahratta Avenue, Wahroonga, NSW	315.00	''	''
Ms Jyllian Anderson, 904/21 Oxford Street, Bondi Junction, NSW	127.00	''	''
Mr Rodney Graeme Anderson, 3 Fernvale Crescent, Mulgrave	125.00	''	''
Maurice Kenneth Anderson, Unit 8, Belair, 33 Oxlade Drive, New Farm, Qld	173.65	''	28/04/00
Mr Colin Anderson, 17 Himley Street, Adelaide, SA	100.00	''	27/10/00
Oscar Lopez Andino & Oscar Andino, 1 Gellion Place, Roxburgh Park	100.00	''	27/10/00
Andjen Pty Ltd, Box 1014, Griffith, NSW	240.00	''	28/04/00
Andjen Pty Ltd, Box 1014, Griffith, NSW	300.00	''	27/10/00
Mr Raymond Andretich, "Joanne Andretich A/c", 68 Crowcombe Way, Karinyup, WA	232.00	''	28/04/00
Mr Raymond Andretich, "Joanne Andretich A/c", 68 Crowcombe Way, Karinyup, WA	290.00	''	27/10/00
Melinda C. Andrews, 119 North Street, Cottesloe, WA	190.00	''	''
Andrews Consulting Group Pty Ltd, "Andrews Family A/c", 42 Evans Street, Bronte, NSW	144.00	''	28/04/00
Andrews Consulting Group Pty Ltd "Andrews Family A/c", 42 Evans Street, Bronte, NSW	343.95	''	''
Josephine Ang, "Josan Ang A/c", 17 Clarkes Road, Ramsgate, NSW	140.00	''	27/10/00
Mrs Poh Yean Ang, 8 Endell Ridge, Mt Claremont, WA	1,507.25	''	28/04/00
Stephen Michael Angel, 6 Cook St, Muswellbrook, NSW	114.65	''	''
Mr Michael Lee Anghie, "Speedboat Superfund A/c" GPO Box W2106, Perth, WA	120.70	''	''
Carolyn Tracey Angus & Mark Gerard Angus, 680 Riddell Road, Sunbury	100.00	''	27/10/00
Mr Steven Ankers, PO Box 1184, Campbelltown, NSW	200.00	''	''

Kathleen Mary Anlezark, "Sara & Bridget Anlezark", 18 Latona Street, Winston Hills, NSW	100.00	"	"
Ann Grealis, 15/2 Pearson Street, Balmain, NSW	112.00	"	28/04/00
Anraz Pty Limited "Super Fund A/c", Unit 104, 66 Darling Point Road, Darling Point, NSW	179.20	"	"
Graham Martin Anscombe, 11 Melita Road, Cambridge Park, NSW	100.00	"	27/10/00
Annette Anskey & Edward Andrew Andrew Anskey, C/ Vitality Health Green Slopes, Shop Lo, Green Slopes, Qld	100.00	"	"
Ansore Pty Ltd, "Maiolo S/F A/c", 7 Dale Street, Brookvale, NSW	120.00	"	"
Lisa Anthony & Mark Danta, 3 Avona Avenue, Glebe, NSW	220.00	"	"
Giuliana Antolovich, 2A The Boulevard, Balwyn North	120.00	"	28/04/00
Enrique Antonio, 17 Younger Street, Coburg	112.00	"	"
Enrique Antonio, 17 Younger Street, Coburg	140.00	"	27/10/00
Rosamund Antoniou, 23 Barcoo St, East Roseville, NSW	160.00	"	"
Joseph Andrew Apap, 8 Burke Street, Blacktown, NSW	100.00	"	"
Mr Robert David Appleby, Level 7, 77 Pacific Highway, North Sydney, NSW	1,600.00	"	28/04/00
Linda Anne Apthorpe & Michael John Apthorpe, PO Box 194, Pendle Hill, NSW	100.00	"	27/10/00
Aqua Marine Freight Services, 10/75 Jersey Street, Hornsby, NSW	120.70	"	28/04/00
Taghreed Arasoul, 4/76-78 Williamsons Rd, Doncaster	128.00	"	"
Arbor Communications Pty Ltd, PO Box 681, Edgecliff, NSW	144.95	"	"
Arbor Oak Pty Ltd, "Mezic Family Super Fund A/c", 24 Edwin Terrace, Gilberton, SA	100.00	"	27/10/00
Anne Maria Archer, 2/37 Benelong Road, Cremorne, NSW	100.00	"	"
Mr David Archer, "Venetia E Archer A/c", 3 Tregunter Road, London Sw10 9ls United Kingdom	140.00	"	"
Anthony Arden & Felix Wilfrid Arden, "Anthony Arden S/Fund A/c", 308/201 Alexandra Wickham Te, Brisbane, Qld	140.00	"	"
Miss Nancy Arena & Mr Salvatore Maurizio Arena, 15 Bourke Street, Yokine, WA	112.00	"	28/04/00
Miss Nancy Arena & Mr Salvatore Maurizio Arena, 15 Bourke Street, Yokine, WA	140.00	"	27/10/00
Thanos Argyropoulos, 16 Holroyd Street, Kew,	385.00	"	"
Leon Argyropoulos & Aliko Argyropoulos, 16 Holroyd Street, Kew	200.00	"	"
Aliko Argyropoulos & Thanos Argyropoulos, 16 Holroyd Street, Kew	200.00	"	"
Mr Brock Arifovic, 4 Mirabella Court, Warrandyte	160.00	"	"
Brock Simon Arifovic & Corey Neil John Arifovic, 11 Mirabella Court, Warrandyte	200.00	"	"
Mr Tony Armiento, C/- Black & Krantz, Level 3, 222 Kingsway, South Melbourne	100.00	"	"
Armiento Nominees Pty Ltd, "Tony Armiento Family A/c", C/- Black & Krantz, Level 3, 222 Kingsway, South Melbourne	100.00	"	"
Stephen Charles Armitstead & Lorna Jean Armitstead, 109 Coulstock Street, Warrnambool	192.00	"	28/04/00

Peter Armstrong, 3 Harst Place, Belrose, NSW	100.00	''	27/10/00
Trevor Armstrong, 4 MacRobertson Cl, Fitzroy	120.70	''	28/04/00
Trevor Armstrong, 4 MacRobertson Cl, Fitzroy	200.00	''	27/10/00
Kevin Robert Armstrong, "Armstrong Super Fund A/c", 132 Avondale Road, Pitt Town, NSW	100.00	''	''
Barry Alfred Arnold, 10 Natham Road, South Lake, WA	224.00	''	''
Mr Darren Arnold, Unit 13, 20 Smith Street, Wollongong, NSW	100.00	''	''
Brenton R. Arnott-Smith Fairbanks, Lot 28, Mount Road, Bowral, NSW	120.00	''	''
Ador E Arredondo & Demetria Arredondo & Ador's Cleaning Contract Services, 1 Carlyle Court, Buderim, Qld	200.00	''	''
Henry James Arrow, 125 Julia Flynn Ave, Isaacs, ACT	120.00	''	''
Kenneth Edward Arthur & Shirley Margaret Arthur, 47 Juvenis Avenue, Oyster Bay, NSW	100.00	''	''
Artsoft Pty Ltd, 36 Saint Elmo Road, Ivanhoe	108.00	''	''
Arumpus Building Coy Pty Ltd, 125 Nepean Highway, Seaford	120.70	''	28/04/00
Arumpus Building Coy Pty Ltd, 125 Nepean Highway, Seaford	200.00	''	27/10/00
Dr Banu Arumugam, 31 Glenard Drive, Eaglemont	100.00	''	''
Nader Asace, 17/37 Paul Street, Bondi Junction, NSW	120.00	''	''
Remo Ascenzo, 700 Sydney Road, Coburg	120.00	''	28/04/00
Vicki Gail Ash, 6 Daniel Court, Planland, Qld	256.00	''	''
Vicki Gail Ash, 6 Daniel Court, Planland, Qld	320.00	''	27/10/00
Graham Joseph Ashby, 57 Fairlight Street, Fairlight, NSW	200.00	''	''
Mark Asher, 5 Pasteur Street, Elizabeth Vale, SA	325.00	''	''
Ashmaw Pty Limited "Ashmaw Super Fund A/c" PO Box 3686, Hamilton DC, NSW	125.00	''	''
Kerry Aspland, PO Box 1827, Windaroo Mackay, Qld	120.00	''	28/04/00
Wayne Aspland, PO Box 1827, Nindaroo Mackay, Qld	120.00	''	''
Mr Charles Assaf & Mrs Colette Assaf, 97 Wattle Street, Punchbowl, NSW	220.00	''	27/10/00
Martin Stackpool & Associate, 195 Mitchell Street, Stockton, NSW	180.00	''	''
Associated Planners Financial Services Limited, Locked Bag 26, Epping, NSW	100.00	''	''
Gregory Astegno, 5 Perceval Way, East Doncaster	249.60	''	28/04/00
Asterlink Pty Ltd, 21 Rosserdale Crescent, Mt Eliza	262.65	''	''
Asterlink Pty Ltd, 21 Rosserdale Crescent, Mt Eliza	435.00	''	27/10/00
Mr Dennis Aston, PO Box 109, Thornleigh, NSW	200.00	''	28/04/00
Ms Catherine Aston, PO Box 109, Thornleigh, NSW	200.00	''	''
C.E.M. Atahan, 5 Stratford Street, East Fremandle, WA	100.00	''	27/10/00
Alan John Atkins, 6 Ulva Place, Macquarie, ACT	100.00	''	''
Joan Susan Atkinson, 1 Onslow Street, Latham, ACT	120.00	''	28/04/00
James Chetwynd Atkinson, 503 Sandy Bay Road, Sandy Bay, Tas	100.00	''	27/10/00
Sharon Anne Atkinson, 15 Chuter Avenue, Southport, Qld	339.20	''	28/04/00
Sharon Anne Atkinson, 15 Chuter Avenue, Southport, Qld	424.00	''	27/10/00
Eric Atkinson, PO Box 243, Balgowlah, NSW	200.00	''	''
Ms Sharron Atkinson, 15 Chuter Avenue, Southport, Qld	160.00	''	28/04/00
Ms Sharron Atkinson, 15 Chuter Avenue, Southport, Qld	200.00	''	27/10/00

Ms Sharon Anne Atkinson, 6 St Pauls Place, Isle of Capri, Qld	100.00	''	''
Marguerite Ann Atkinson, 503 Sandy Bay Road, Sandy Bay, Tas	240.00	''	''
Mr Raymond George Atkinson, 1/62 Raglan Street, Mosman, NSW	112.00	''	28/04/00
Mrs Donna Marie Atkinson, 1 Monson Court, Leeming, WA	119.70	''	27/10/00
Mrs Marguerite Ann Atkinson & Mr James Chetwynd Atkinson "Atkinson Family A/c", 503 Sandy Bay Road, Sandy Bay, Tas.	100.00	''	''
Noeleen Atwell, 2/27 Radnor Street, Indooroopilly	140.00	''	''
Cheng Au, 4 Soderlund Drive, Doncaster	140.00	''	''
Raymond Au, 4 Soderlund Drive, Doncaster	140.00	''	''
Osama Auda, Unit 4, 74-78 Williamsons Road, Doncaster	102.55	''	28/04/00
Thomas John Auld & Brian William Auld, "Auld & Sons P/L S/Fund A/c", PO Box 321, Kyabram	100.00	''	27/10/00
Brian Auld & Thomas Auld, "Auld & Sons P/L S/Fund A/c", PO Box 321, Kyabram	144.00	''	28/04/00
Brian Auld & Thomas Auld, "Auld & Sons P/L S/Fund A/c" PO Box 321, Kyabram	180.00	''	27/10/00
Brian Auld & Eileen Auld, "MH&JF Auld & Sons PI SF A/c", PO Box 321, Kyabram	100.00	''	''
Lynette K. Aulick, 21 The Avenue, Montrose	190.00	''	''
Aurora Management Pty Limited, "Ehmcke Family S/Fund A/c", 3/3 Bellevue Park Road, Bellevue Hill, NSW	140.00	''	''
Aurora Management Pty Ltd, 3/3 Bellevue Park Road, Bellevue Hill, NSW	140.00	''	''
Tim John Austin, 16 Bevington Road, Glenunga, SA	100.00	''	''
Mr Philip Austin, C/- Hardings Solicitors, Level 1, 1 York Street, Sydney, NSW	160.00	''	''
Australian Fasteners Pty Ltd "Freeman Super Fund A/c", Lot1/45-53 Stern Road, Carbrook, Qld	180.00	''	''
Australian Gigahertz Network Pty Ltd, 11/155 Castlereagh Street, Sydney, NSW	160.00	''	28/04/00
Austrasin Pty Ltd, 2 Palana Road, City Beach, WA	512.65	''	''
Austrasin Pty Ltd, 2 Palana Road, City Beach, WA	850.00	''	27/10/00
Ourania Avelkiou, 29 Morotai Avenue, Ashburton	100.00	''	''
Patrica Fay Avery, Lot 1, Main Road, Mount Vincent, NSW	200.00	''	''
Irene May Avgenicos, 29 Moore Park Road, Centennial Park, NSW	100.00	''	''
Dimitrios Avgoulis & Eugenie Avgoulis, 21 Cooper Avenue, Altona North	205.60	''	28/04/00
AW Bell Pty Ltd, "Retirement Fund A/c", 4-6 King Street, Oakleigh	100.78	''	''
AW Bell Pty Ltd, "Retirement Fund A/c", 4-6 King Street, Oakleigh	166.60	''	27/10/00
AXA Trustees Limited, "B M Kinloch Pty Ltd S/F A/c", 2/65 Southbank Boulevard, South Melbourne	241.45	''	28/04/00
AXN Pty Ltd, "Riversdale A/c", 23A Redan Street, Balmoral, NSW	200.00	''	27/10/00
Axquest Pty Limited "Super Fund A/c", PO Box 79, Macquarie Fields, NSW	120.00	''	''

Peter Robert Axten & Julie Ann Axten, 12 Franklin Street, Alfredton	100.00	''	''
Nigel P. Aylott, TRL PO Box 249, Clayton	1,548.00	''	''
Mr John Ayre, 12a Chelmsford Avenue, Croydon, NSW	188.50	''	28/04/00
Mr John Ayre, 12a Chelmsford Avenue, Croydon, NSW	312.00	''	27/10/00
Steven Graham Ayre, 20 Bancks Street, McKellar, ACT	360.00	''	''
Joseph Roland John Ayres, 105 Duke Street, Brisbane, Qld	100.00	''	''
B. & L. Engineering Construction Pty Limited, "Stojanoski Super Fund A/c", PO Box 589, Queanbeyan, NSW	500.00	''	''
B. & M. Holdings Pty Ltd, 22 Aspendale Place, Hillarys, WA	133.00	''	''
B. C. Panen Pty Ltd, 602 Barkly Street, West Footscray	100.00	''	''
B. J. Barnell Pty Ltd, 117 King William St, Adelaide, SA	348.80	''	28/04/00
B. J. Barnell Pty Ltd, 117 King William St, Adelaide, SA	436.00	''	27/10/00
B. J. Rutherford Pty Ltd, "B Rutherford Family A/c", Crewkerne Station, Muttaborra, Qld	100.00	''	''
Mr Neville Janus Baay & Ms Natalya Williams, 55 Lady Penrhyn Drive, Beacon Hill, NSW	100.00	''	''
Howard William Babbage & Gregory Francis Smith, 25 16/22 Lyall Street, Leichhardt, NSW	100.00	''	''
Ms Melissa Ann Babbage, 106/14 Blues Point Road, McMahons Point, NSW	480.00	''	28/04/00
Geoffrey James Babington & Margaret Cunningham Babington, 23 Stanton Road, Haberfield, NSW	160.00	''	''
Geoffrey James Babington & Margaret Cunningham Babington, 23 Stanton Road, Haberfield, NSW	200.00	''	27/10/00
Ian William Bacchus, 41 Station Road, Otford, NSW	100.00	''	''
Jillian Kaye Baddeley & Corinne Therese Antonoff, PO Box 29, Omeo	100.00	''	''
Mr Guy Bader, 6/57 Liverpool Street, Rose Bay, NSW	120.00	''	''
Bafra Pty Ltd "Wilson A/c", 10 Pindari Road, City Beach, WA	100.00	''	''
Ross Anthony Baglin & Meredith Jean Baglin, 8 Clive Street, Alphington	160.00	''	28/04/00
Gurdev Kaur Bahia, 5 Diosma Court, Narre Warren	140.00	''	27/10/00
Bahja Holdings Pty Ltd, 133 Cross Rd, Highgate, SA	169.60	''	28/04/00
Bahja Holdings Pty Ltd, 133 Cross Rd, Highgate, SA	212.00	''	27/10/00
Anne Marie Bahnisch, 4/69 Oxford Street, Epping, NSW	100.00	''	''
Mr Lixiang Bai, 26 Barellan Avenue, Carlingford, NSW	120.00	''	''
Mary Lou Bailey, 12/1424 Leopold Street, South Yarra	151.00	''	28/04/00
Mary Lou Bailey, 12/1424 Leopold Street, South Yarra	250.00	''	27/10/00
Rodney John Bailey & Michelle Robyn Bailey, 24 Charkers Street, South Penrith, NSW	100.00	''	''
Mrs Margaret Bailey, 316 Maroondah Highway, Croydon	195.00	''	''
Tony Bainbridge, Unit 6, 38 Lissner Street, Toowong, Qld	120.00	''	28/04/00
Tony Bainbridge, Unit 6, 38 Lissner Street, Toowong, Qld	150.00	''	27/10/00
Bainsford Pty Limited, "Bainsford Super Fund A/c", PO Box 6101, Toowoomba, Qld	140.00	''	''
Elsbeth Baird & Sean Whelan, "Baird Films Super Fund A/c", 16 Conyngham Street, Glenside, SA	180.00	''	''

Elsbeth Baird & Sean Patrick Whelan, "Baird Films Prod S/Fund A/c", 16 Conyngham Street, Glenside, SA	180.00	"	"
Enver Bajraszewski, 48 Lucknow Street, Ascot Vale	362.15	"	28/04/00
Enver Bajraszewski, 48 Lucknow Street, Ascot Vale	600.00	"	27/10/00
Ms Alethea Bajraszewski, 48 Lucknow Street, Ascot Vale	120.70	"	28/04/00
Ms Alethea Bajraszewski, 48 Lucknow Street, Ascot Vale	200.00	"	27/10/00
Ms Alethea Anne Bajraszewski, 48 Lucknow Street, Ascot Vale	120.70	"	28/04/00
Ms Alethea Anne Bajraszewski, 48 Lucknow Street, Ascot Vale	200.00	"	27/10/00
Barry Terance Baker, PO Box 6333, Upper Mt Gravatt, Qld	100.00	"	"
Estate William John Baker, C/- Ken Faulkner, PO Box 236, Kyneton	100.00	"	"
Graeme Robert Baker, 6 Belmont Street, Belmont	100.00	"	"
Robyn Maree Baker, 154 Didbrook Street, Robertson, Qld	100.00	"	"
Mark Adam Baker, 154 Didbrook Street, Robertson, Qld	100.00	"	"
Catherine Maree Baker, 154 Didbrook St, Robertson, Qld	100.00	"	"
Mr Warren Baker, "James & Victoria Baker A/c", 105a Cecil Avenue, Castle Hill, NSW	110.00	"	"
John Winston Baker & Barbara Baker, "Baker Retirement Fund", 7 Thor Street, Victoria Point, Qld	110.00	"	"
Jennifer L Baker-Finch, 1/247 Park Street, South Melbourne	217.20	"	28/04/00
Jennifer L Baker-Finch, 1/247 Park Street, South Melbourne	360.00	"	27/10/00
Dicran Charles Bakirgian, PO Box 346, Mascot, NSW	112.00	"	28/04/00
Glenn Bakyew, 201 Mont Albert Road, Surrey Hills	460.00	"	27/10/00
Narelle Eunice Bakyew, 201 Mont Albert Road, Surrey Hills	460.00	"	"
Rama Balaraman & Dilip Viswanath Arcot, 16 Blackstone Road, Launceston, Tas.	100.00	"	"
Robert James Baldock & Bonnie Rosalind Baldock, 11 Dryden Avenue, Hazelwood Park, SA	100.00	"	"
Richard Baldwin, 5 Torrens Street, College Park, SA	132.85	"	28/04/00
Richard Baldwin, 5 Torrens Street, College Park, SA	220.00	"	27/10/00
Mr Richard John Baldwin, 5 Torrens St, College Park, SA	120.00	"	"
Mr David Allan Baldwin, 12 Phair Court, Altona	100.00	"	"
Mr Kevin John Baldwin, PO Box 1745, Port Moresby NCD, Papua New Guinea	369.50	"	28/04/00
Mr Kevin John Baldwin, PO Box 1745, Port Moresby NCD, Papua New Guinea	500.00	"	27/10/00
Anesh Balgobind, 19 Morris Drive, Keilor Downs	100.00	"	"
Miranda Jane Ball, 17 Glynne Road, Ringwood North	100.00	"	"
Nereda Anne Ball, PO Box 299, St Helens, Tas	100.00	"	"
Felicity Ann Ball, 9 Bell Street, Hawthorn	100.00	"	"
Mr Eric Oscar Balle, 4 Sollenerf, 1654 Huizingen, Belgium	120.00	"	"
Marjorie Brenda Ballingall, 27 View Terrace, East Fremantle, WA	160.00	"	"
David Charles Balog, 14 William Edward Street, Longueville, NSW	108.00	"	"
Mrs Antoinette Balog, 14 William Edward Street, Longueville, NSW	348.00	"	28/04/00
Sarah Balson, 32 Bryson Street, Canterbury	100.00	"	27/10/00
Ross Balson, 32 Bryson Street, Canterbury	100.00	"	"
Kathy Baltas, 4 Merbow Street, Oakleigh	143.00	"	"

Balvenor Pty Ltd, PO Box 5173, Nambour, Qld	560.00	''	''
Dr Kristina Bamford, "K Bamford Medical Pty Ltd S/F A/c", PO Box 363, Burnside, SA	108.00	''	''
Pankaj Kumar Bamola, 6 West Street, Bathurst, NSW	100.00	''	''
Mr James Banaghan, "Family A/c", 134 Fifth Avenue, Windsor	120.70	''	28/04/00
Mr James Banaghan "Family A/c", 134 Fifth Avenue, Windsor	200.00	''	27/10/00
Banchi Enterprises Pty Ltd, 10/170 Commercial Rd, Prahran	164.00	''	''
Bancoora Park Pty Ltd, PO Box 31, Chelsea	100.00	''	''
John Bancroft & Sharyn Bancroft, 118 Skellatar Stock Route, Museellark, NSW	100.00	''	''
Philip Bancroft, 36 Brook Street, Muswellbrook, NSW	120.00	''	''
Jason Bandouvakis, Po Box 775, West Perth, WA	260.00	''	''
Tina Bantias, 8 Parklea Close, Templestowe	112.00	''	28/04/00
Katrina McGarrity Banks, 29 Millstream Road, Werrington Downs, NSW	120.00	''	27/10/00
Mr Glenn David Banks, 495 Uhlmann Rd, Burpengary, Qld	100.00	''	''
Mr Wayne Banks & Ms Emma Seberry, PO Box 84, Beecroft, NSW	210.00	''	''
Christopher Patrick Bannah, 5 Dunluce Court, Keperra, Qld	134.20	''	''
Clare Bannenberg, 81 Gower Street, Kensington	100.00	''	''
Margaret L Bannister, 4 Yelgun Place, Lenah Valley, Tas.	100.00	''	''
Roslyn D Banwell, 3/1 Boronia Street, Wollstonecraft, NSW	105.60	''	28/04/00
Ivan James Baptist & Patricia Philomena Baptist, 91 Betula Street, Doveton	153.60	''	''
Milenco Barbaric, 299 Canterbury Road, St Kilda West	100.00	''	27/10/00
Barbary Coast Investments Pty Limited, Level 30, 133 Castlereagh Street, Sydney, NSW	160.00	''	28/04/00
Barbary Coast Investments Pty Ltd, Level 30, 133 Castlereagh Street, Sydney, NSW	160.00	''	''
Anita Barbuto, 51/192 Vimiera Road, Marsfield, NSW	100.00	''	27/10/00
Joseph Michael Barca, 21 Elora Road, South Oakleigh	100.00	''	''
Joseph Barca "Angela Barca A/c", 21 Elora Road, South Oakleigh	100.00	''	''
Jeffrey Barcham, 83 Nicholson Avenue, Thornleigh, NSW	100.00	''	''
Guy Esmond Baring, 126 Williams Road, Prahran	100.00	''	''
John Pallister Barkas, PO Box 281, Pymble, NSW	140.00	''	''
Leigh Anthony Barker, 2 Moondani Road, Beverly Hills, NSW	164.25	''	28/04/00
Leigh Anthony Barker, 2 Moondani Road, Beverly Hills, NSW	272.00	''	27/10/00
Jacqueline Barlow, 108 Bathurst Street, Pitt Town, NSW	140.00	''	''
Ron Barnacle, 49 Troy Street, Bonbeach	400.00	''	''
Janet Annie Barnard, 8 Power Street, Wavell Heights, Qld	120.70	''	28/04/00
Neil Gerard Barnden, 18 Barter St, Whyalla Playford, SA	200.00	''	27/10/00
Kenneth Barnes & Janice Elva Faye Barnes, Edenville Via Kyogle, NSW	100.00	''	''
Stephen John Barnett & Debbie Lorraine Barnett, Lot 2 Emily Street, Bridport, Tas.	128.00	''	28/04/00
Peter David Barr, 24 Stanley Street, Ivanhoe	150.00	''	27/10/00
Edna Curry Barr, 24 Stanley Street, Ivanhoe	150.00	''	''

Mr Joseph Patrick Barrett, 16/7 Braddock St, Robertson, Qld	100.00	''	''
Arthur Russell Barrie, 375 Glenfern Road, Upwey	100.00	''	''
Mr Colin Barrie & Mrs Lynette Barrie, 218 Village Baxter, 8 Robinsons Road, Baxter	100.00	''	''
Mrs Carla Suzanne Barrie, 17 Victoria Street, Oak Park	298.00	''	''
Simon James Barritt-Eyles, Sherwood Gardens, 15/14 Marr Street, Pearce, ACT	200.00	''	''
Mr Peter Barro, PO Box 18043, Melbourne	120.00	''	''
Paul Traynor Barry, 38 Wattle Avenue, Carina, Qld	144.95	''	28/04/00
Paul Traynor Barry, 38 Wattle Avenue, Carina, Qld	240.00	''	27/10/00
Bryan Joseph Barry "Jane Elizebeth Barry A/c", 36 Ensign Street, Narrogin, WA	100.00	''	''
Grahame J. Barry, 52 Carina Road, Oyster Bay, NSW	108.70	''	''
Mr Peter George Barry, 49 Spencer Street, Lawnton, Qld	195.00	''	''
Barry Petroleum Pty Ltd, "Barry Super Fund A/c", PO Box 435, Queanbeyan, NSW	130.00	''	''
John Alexander Barton, 16 Haughton Parade, Rosanna	127.90	''	28/04/00
John Alexander Barton, 16 Haughton Parade, Rosanna	212.00	''	27/10/00
Anthony John Thomas Basile & Antonina Basile, 188 Brougham Street, Kew	120.00	''	''
Antonia Basile, 29 Stewart Street, Richmond	120.00	''	''
Anthony John Thomas Basile & Antonia Basile, 29 Stewart Street, Richmond	120.00	''	''
Miranda Jane Baskerville, 53 Range Road, West Pennant Hills, NSW	100.00	''	''
Yasmine Helen Bassili, 33 Toxteth Road, Glebe, NSW	100.00	''	''
Howard Bastain, 10 Adamson Drive, Endeavour Hills	100.00	''	''
Charmaine June Bastion, 10 Adamson Drive, Endeavour Hills	100.00	''	''
Olivia Maria-Teresa Basto, 262A Annangrove Road, Annangrove, NSW	125.65	''	28/04/00
Christine Batchelor, 42 The Serpentine, Brisbane, Qld	100.78	''	''
Christine Batchelor, 42 The Serpentine, Brisbane, Qld	166.60	''	27/10/00
Cheryl Bate, 5 Sybil Street, Newport Beach, NSW	140.00	''	''
Anne Bate, C/- John Grace, Ms Rowena, GPFM, Level 7, 58 Pitt Street, Sydney, NSW	124.00	''	28/04/00
Jeanette Helen Bates, 12/306 West Coast Highway, Scarborough, WA	120.00	''	27/10/00
Mr Anthony Peter Bates, "Tony Bates S/F A/c", 122 Wallumatta Road, Newport, NSW	150.00	''	''
Kulvinder Bath & Gurmaj Singh, PO Box 331, Granville, NSW	151.00	''	28/04/00
Mr Jason Franco Battistessa, 72 Renwick Street, Drummoyne, NSW	160.00	''	''
Helen Laurel Bayley, 12 Maple Ave, Pennant Hills, NSW	100.00	''	27/10/00
Mr Craig A. Bayliss, Unit 23, 150 Forbes Street, Woolloomooloo, NSW	240.00	''	28/04/00
Baytron Pty Ltd, 9/174 Phillip Street, Sydney, NSW	240.00	''	27/10/00
Bazaarcha Pty Ltd, "Superarcher A/c", 264 Water Street, Spring Hill, Qld	103.00	''	''
Bazaarcha Pty Ltd "Superarcher A/c", 264 Water Street, Spring Hill, Qld	200.00	''	''
Bazello Pty Limited, 28 Clyde Avenue, Lockleys, SA	240.00	''	''
Est William Charles Beach, 8 Abelia St, Toowoomba, Qld	100.00	''	''

Stephanie Beale, 131/95 Elizabeth Bay Road, Elizabeth Bay, NSW	100.00	''	''
Robert Beard & Phoebe Beard & "Mark Beard A/c", 24 Berkdale Ave, Clarence Park, SA	120.70	''	28/04/00
Elizabeth Diana Beardall, 303 Autumn Street, Newtown	320.00	''	''
Elizabeth Diana Beardall, 303 Autumn St, Newtown	400.00	''	27/10/00
Alan Geoffrey Beardsmore, 3/12 Mons Avenue, West Ryde, NSW	100.00	''	''
Angela Michelle Beasley & Peter Hilton Beasley, 51/79 Boyce Road, Maroubra, NSW	100.00	''	''
Yvonne Mary Beath, 28 Busby Parade, Bronte, NSW	160.00	''	28/04/00
DAvid Murray Beaton, 13 Lockwood Street, Yokine, WA	100.00	''	27/10/00
Beudet Pty Limited, Po Box 1741, Neutral Bay, NSW	200.00	''	''
Beaumaris 3193 Pty Ltd, 26/164 Maquarie Street, St Lucia, Qld	370.00	''	''
Beaumont Trucking Pty Ltd, "Beaumont Trucking Super A/c", 36 Golf Circuit, Tura Beach, NSW	165.00	''	''
David J. Bebee, 124 Joel Terrace, Mount Lawley, WA	160.00	''	''
Bebo Holdings Pty Ltd, "The Empty Nest Whoppie Fund A/c", Unit 2, 512 Mulgrave Road, Cairns, Qld	188.00	''	''
Justine Beck, 7/66 Knotts Avenue, Bondi Beach, NSW	120.00	''	''
Anthony Beckingsale & Luke Jessica Beckingsale, 77A Furness Street, Kangaroo Flat	100.00	''	''
Bectore Investments Pty Ltd, PO Box 193, Vermont	132.85	''	28/04/00
Bectore Investments Pty Ltd, PO Box 193, Vermont	220.00	''	27/10/00
Bedford Investments Pty Ltd, 17 Portland Street, Nedlands, WA	116.00	''	28/04/00
Beeljay Holdings Pty Ltd, 490 Wellington Road, Mulgrave	261.60	''	''
Beeljay Holdings Pty Ltd, 490 Wellington Road, Mulgrave	327.00	''	27/10/00
Ronda Beer, 58 Auburn Grove, Hawthorn East	100.00	''	''
Paul Norman James Behn, "Behn Family A/c", 46 Penderlea Drive, West Pennant Hills, NSW	176.00	''	28/04/00
Elise Beilharz, 2 Margaret Ave, Bayswater	144.95	''	''
Elise Beilharz, 2 Margaret Ave, Bayswater	240.00	''	27/10/00
Robertino Belicovski, 27 Kelvin Road, Alphington	128.00	''	28/04/00
Robinco Belicovski, 27 Kelvin Road, Alphington	128.00	''	''
John Alexander Bell, 23/19 Blaxland Avenue, Newington, NSW	120.70	''	''
John Alexander Bell, 23/19 Blaxland Ave, Newington, NSW	200.00	''	27/10/00
Nigel Frank William Bell, 58 Mundy Street, Bendigo	192.00	''	28/04/00
Nigel Frank William Bell, 58 Mundy Street, Bendigo	240.00	''	27/10/00
Alistair Garrard Bell, "Emma Lucy May Bell A/c", 15 Blenheim Road, Lindfield, NSW	603.10	''	28/04/00
Alistair Garrard Bell, "Sophie Alexandra Bell A/c", 15 Blenheim Road, Lindfield, NSW	241.45	''	''
Geoffrey Thomas Bell, 3 Alfred Avenue, Cronulla, NSW	176.35	''	''
Nicholle Annette Bell, 10 Eldon Street, Dianella, WA	100.00	''	27/10/00
Mr R. Bell & Mrs E. Bell, "R. W. Bell Super Fund A/c", PO Box 1096, Niddrie	208.00	''	28/04/00
Mr R. Bell & Mrs E. Bell, "R. W. Bell Super Fund A/c", PO Box 1096, Niddrie	260.00	''	27/10/00

David Michael Bellamy, 8/67 Lincoln Street, Belfield, NSW	321.04	''	28/04/00
David Michael Bellamy, 8/67 Lincoln Street, Belfield, NSW	401.30	''	27/10/00
Louie Bellas, 44 Westbourne Lane, Highgate Hill, Qld	144.00	''	28/04/00
Louie Bellas, 44 Westbourne Lane, Highgate Hill, Qld	180.00	''	27/10/00
Frank Belzunce, 769 Canterbury Road, Surrey Hills	160.00	''	''
Michael Graham Benbow, 6 Trusley Way, Karrinyup, WA	100.00	''	''
Carla Gina Bendo & Larry Richard Watson, 7 Birnie Avenue, Kensington Park, SA	100.00	''	''
Denise Benedict, 51 Ballan Road, Werribee	100.00	''	''
Itzhakk Benedikt, 266 High Street, Prahran	100.00	''	''
Benmar Concretors (Vic) Pty Ltd, "Super Fund Account", 19 View Crescent, Montrose	100.00	''	''
Anthony Gordon Bennett, 48 Stewart Street, Boronia	104.00	''	28/04/00
Anthony Gordon Bennett, 48 Stewart Street, Boronia	130.00	''	27/10/00
Michael Griffin Bennett, 5673 Bass Highway, Elizabeth Town, Tas.	120.00	''	''
James Harry Bennett, 200b Raglan Street, Mosman, NSW	108.00	''	''
Mrs Jean Berah, 48 Harcourt Street, East Hawthorn	100.00	''	''
Mr Tony Bergin "Bergin Homes Super Fund A/c", C/- Clark & Assoc, PO Box 924, Springwood, Qld	233.60	''	28/04/00
Jean Berguistain, 1 Bimbil Street, Blacktown, NSW	100.78	''	''
Jean Berguistain, 1 Bimbil Street, Blacktown, NSW	166.60	''	27/10/00
Estate Leon Berk, C/- Windeyer Dibbs, 25 O'Connell Street, Sydney, NSW	208.00	''	''
Glenn Bermingham, 4 Kyeamba Grove, Toorak	272.85	''	28/04/00
Glenn Bermingham, 4 Kyeamba Grove, Toorak	452.00	''	27/10/00
Glen Bermingham & Joyce Bermingham, 4 Kyeamba Grove, Toorak	120.00	''	''
Glen Bermingham & Richard Bermingham, 4 Kyeamba Grove, Toorak	120.00	''	''
Glenn Bermingham & Nerida Bermingham, 4 Kyeamba Grove, Toorak	120.00	''	''
Glen Bermingham & Aaron Burmingham, 7 Cuthbert Court, Wantirna South	120.00	''	''
Robyn Bernitz, PO Box 5062, Kenmore East, Qld	256.00	''	28/04/00
Robyn Bernitz, PO Box 5062, Kenmore East, Qld	320.00	''	27/10/00
Harold Bernitz, PO Box 5062, Kenmore East, Qld	240.00	''	28/04/00
Harold Bernitz, PO Box 5062, Kenmore East, Qld	300.00	''	27/10/00
Megan Bernitz, "Harold Bernitz A/c", PO Box 5062, Kenmore East, Qld	160.00	''	28/04/00
Megan Bernitz, "Harold Bernitz A/c", PO Box 5062, Kenmore East, Qld	200.00	''	27/10/00
Danielle Bernitz, "Harold Bernitz A/c", PO Box 5062, Kenmore East, Qld	160.00	''	28/04/00
Danielle Bernitz, "Harold Bernitz A/c", PO Box 5062, Kenmore East, Qld	200.00	''	27/10/00
Harold Bernitz, PO Box 5062, Kenmore East, Qld	160.00	''	28/04/00
Harold Bernitz, PO Box 5062, Kenmore East, Qld	200.00	''	27/10/00
Dorothy Berry, 1 Conebush Crescent, Aarona, Qld	100.00	''	''
Mr Damian Timothy Berry, 223 Burke Road, Glen Iris	120.70	''	28/04/00
Mr James Berry, Unit 12C, 55/57 Wong Mai Chung Road, Happpy Valley, Hong Kong	120.70	''	''
Mr Mark Berryman, 43 McLean Avenue, Bentleigh	100.00	''	27/10/00

Bertold Nominees, "Bertold Super Fund A/c", 3 Porto Novo Mews, Secret Harbour, WA	100.00	"	"
Mr Muharem Besim, 3 Coleman Court, Dandenong North	100.00	"	"
Mr Paul John Best, PO Box 1023, Bendigo	151.00	"	28/04/00
Mr Paul John Best, PO Box 1023, Bendigo	250.00	"	27/10/00
Linda Mara Beston & Laurance Alan Beston, 5 Duxson Drive, Templestowe	110.00	"	"
Ms Carol Ann Betlinski, 89 Queen St, Muswellbrook, NSW	200.00	"	"
Mr Christopher John Betson, 8 Peter Street, Pinjarra, WA	110.00	"	"
James W. Beveridge, 42/5 Bronberg Ct, Southport, Qld	120.00	"	"
Frank Hendrik Beverwijk & Watchareeporn Beverwijk, 9 Waraker Road, Hillarys, WA	100.00	"	"
Ranya Bey, 9 Mons Street, Canterbury, NSW	120.70	"	28/04/00
Arun Bharadwaj & Ritu Bharadwaj, 11 Henry Smith Place, Croydon Hills	100.00	"	27/10/00
Mr Ravi Bhatia, 144 Kooyong Road, Toorak	301.55	"	28/04/00
Mr Ravi Bhatia, 144 Kooyong Road, Toorak	500.00	"	27/10/00
Ravi Bhatia, "Anuraag Bhatia A/c", 144 Kooyong Road, Toorak	100.00	"	"
Mr Sameer Bhatia, 144 Kooyong Road, Toorak	100.00	"	"
Mr Ravi Bhatia, 144 Kooyong Road, Toorak	100.00	"	"
Mrs Madhu Bhatia, 144 Kooyong Road, Toorak	1,033.00	"	"
Rakesh Bhushan, 10 Stuarts Road, Katoomba, NSW	105.00	"	"
Mr Yash Bhuta, 45 Station Street, Pymble, NSW	108.00	"	"
Mr Albert John Biagioni, Unit 102, 396 Scarborough Beach Road, Osborne Park, WA	100.00	"	"
Terence John Bianchi, 75/67 Broadbeach Boulevard, Broadbeach, Qld	120.00	"	"
Mr Dominic Biasi, 84 Sydney Street, St Marys, NSW	100.00	"	"
Julie Bickley & Graham Bickley, 18 Sommersea Drive, Raby Bay, Qld	100.00	"	"
Ms Jenny Biggin "Communicating Comp S/F A/c", PO Box H 124, Australia Square, Sydney, NSW	204.00	"	"
Mrs Audrey Wilma Biggs & Mr Ian Grainge Biggs, 3A Balfe Crescent, West Brunswick	100.00	"	"
Miss Christine Biggs, 1/12 Illiliwa Street, Cremorne, NSW	100.00	"	"
Mr Eric Bill, 120/369 Ratprarop Road, Rajathevee Phayathai, Bangkok 10400 Thailand	413.24	"	28/04/00
Indu Billimoria & Ashwin Billimoria, 15 Narallah Grove, Box Hill North	176.00	"	"
Indu Billimoria & Ashwin Billimoria, 15 Narallah Grove, Box Hill North	220.00	"	27/10/00
Billin Investments Pty Ltd "Billin Family A/c", PO Box 14I, Wooli, NSW	150.00	"	"
Geraldine Ruth Billing, 314 West Street, Cammeray, NSW	100.00	"	"
Michael S. Bilsborough, 10 Renwick Street, Glen Iris	272.00	"	28/04/00
Michael S. Bilsborough, 10 Renwick Street, Glen Iris	340.00	"	27/10/00
Peter Michael Bird, 'Bindarby' Modiabeen, Bindoon, WA	100.00	"	"
Fiona Mary Birkett, PO Box 249, North Hobart, Tas.	140.00	"	"
Mr David Birrell, 55 Cutler Road, Clontarf, NSW	169.60	"	28/04/00
Mr David Birrell, 55 Cutler Road, Clontarf, NSW	212.00	"	27/10/00
Alan Thomas Bishop, 47 Mannheim St, Kambah, ACT	140.00	"	"
Winston Bruce Bishop, 9 Rae Street, East Bentleigh	100.00	"	"

John Alexander Bishop, 17 Edmonds Avenue, Ashwood	100.00	''	''
Timothy James Bishop, PO Box 2934, Dubbo, NSW	100.00	''	''
Sergen Bitmansour & Valentina Onano, 30 Bettong Crescent, Bossley Park, NSW	112.00	''	28/04/00
Tryphena Dorothy Bixley, 48 Parsons Ave, Manning, WA	100.00	''	27/10/00
Bizinger And Assoc Pty Ltd, Level 4, 105 Pitt Street, Sydney, NSW	320.00	''	''
Rhonda Bjelan & Branko Bjelan, "Porosa Consolidated Pty Ltd S/F A/c", 8 Reserve Road, Belgrave	100.00	''	''
Nancy Black & John William Bradnock & Christopher John Devonport, PO Box 625, Gisborne, New Zealand	120.00	''	''
Black Ink Pty Ltd, 18 Dillon Street, Paddington, NSW	280.00	''	28/04/00
Mr Stuart Edwin Blackadder & Mr Edwin John Blackadder, Unit 2, 19 Sutherland Court, Darling Point, NSW	100.00	''	27/10/00
Peter Blackeby & Norrie Blackeby, A/11 Short Street, Hunters Hill, NSW	150.00	''	''
Blackrod Corporation Pty Ltd, PO Box Q161, QVB Post Office, NSW	104.00	''	28/04/00
Bladon Communication Pty Ltd, C/- BG Bladon, Ascot, Qld	120.00	''	27/10/00
Rosemary Scott Blair, 4/12 Flavelle St, Concord, NSW	100.00	''	''
Jonathanan MacDonald Blampied, 34 Billyard Avenue, Elizabeth Bay, NSW	120.00	''	''
Alyssa Ann Blanchard, 1/50 Dryden Street, Doncaster East	120.00	''	''
Graham Blandy, 7/75 Pacific Parade, Dee Why, NSW	158.20	''	28/04/00
Graham Blandy, 7/75 Pacific Parade, Dee Why, NSW	262.00	''	27/10/00
Wendy Helen Blanshard, 7/530 Marine Parade, Biggera Waters, Qld	150.00	''	''
Philip Albert Blashki, 11 Tandderwen Court, Narre Warren North	102.40	''	28/04/00
Philip Albert Blashki, 11 Tandderwen Court, Narre Warren North	128.00	''	27/10/00
Mr Damien Blason, 22 Wilson Street, Prospect, SA	100.00	''	''
Maxine Estelle Blaszcak, 22 Barcoo Drive, Moranbah, Qld	100.00	''	''
Ronald Charles Blines & Beryl Greta Blines, 37 Dauphin Terrace, Highgate Hill, Qld	160.00	''	28/04/00
Ronald Charles Blines & Beryl Greta Blines, 37 Dauphin Terrace, Highgate Hill, Qld	200.00	''	27/10/00
D & M Bloink "Super Fund A/c", 732 Hampton Street, Brighton	100.00	''	''
Mr Dean Charles Bloomer & Ms Helen Jennifer Louise Todd, PO Box 3144, Mount Isa, Qld	160.00	''	28/04/00
Mr Dean Charles Bloomer & Ms Helen Jennifer Louise Todd, PO Box 3144, Mount Isa, Qld	200.00	''	27/10/00
Brian Thomas Bloomer, 21 Alderney Rd, South Springvale	100.00	''	''
Stephen J. Blore, Littlewood, Balranald, NSW	100.00	''	''
Blue Carrara Pty Ltd, "Superannuation Fund A/c", PO Box 761, Launceston, Tas.	100.00	''	''

Bluecow Investments Pty Ltd, 3 Urunga Street, North Balgowlah, NSW	150.00	''	''
Bluefin Pty Ltd, 8 Creswick Street, Hawthorn	230.00	''	''
Grant Andrew Blythman, 63 Carter Street, Middle Park	150.00	''	''
BML Nominees Limited, "David Joanna L Holt A/c", GPO Box 7033, Sydney, NSW	408.00	''	''
BML Nominees Limited, "Leaming Pty Ltd A/c", C/- Macquarie Bank Ltd, 20 Bond Street, Sydney, NSW	320.00	''	28/04/00
Eric Bocquot, 5 Bowna Park Drive, Table Top, NSW	180.00	''	27/10/00
Mrs Johanna Margaret Bohm, 20 Ryedale Road, West Ryde, NSW	200.00	''	''
Mr Tibor Bohm, 20 Ryedale Road, West Ryde, NSW	200.00	''	''
Peter Boland, 14/91 Great Western Highway, Parramatta, NSW	100.00	''	''
Sylvia Pauline Bolton, "Emma Louise Bolton A/c", 20 Harold Street, Blackburn	120.70	''	28/04/00
Sylvia Pauline Bolton, "Emma Louise Bolton A/c", 20 Harold Street, Blackburn	200.00	''	27/10/00
Sylvia Pauline Bolton, "Bradley Paul Bolton A/c", 20 Harold Street, Blackburn	120.70	''	28/04/00
Sylvia Pauline Bolton, "Bradley Paul Bolton A/c", 20 Harold Street, Blackburn	200.00	''	27/10/00
Dilys Bolwell, 33 Kunyung Road, Mount Eliza	100.00	''	''
John Bolwell, "Wellstone Pty Ltd A/c", 33 Kunyung Road, Mount Eliza	132.85	''	28/04/00
John Bolwell, "Wellstone Pty Ltd A/c", 33 Kunyung Road, Mount Eliza	220.00	''	27/10/00
John Bolwell, "J. G. Bolwell Pty Ltd A/c", 33 Kunyung Road, Mount Eliza	169.20	''	28/04/00
John Bolwell "J. G. Bolwell Pty Ltd A/c", 33 Kunyung Road, Mount Eliza	280.00	''	27/10/00
Annette Della Bona, 20 Ferrington Road, Leeming, WA	100.00	''	''
Hilton Bonner, 17 Kanimbla Cres, Bil Plat Avalon Beach, NSW	140.00	''	''
Mr David Richard Booth, 12 Kerse Park, Alloway Ayr South Ayrshire, Scotland Ka7 4UT, United Kingdom	134.50	''	28/04/00
Mr David Richard Booth, 12 Kerse Park, Alloway Ayr South Ayrshire, Scotland Ka7 4UT United Kingdom	182.00	''	27/10/00
Mrs Fernanda Mesquita Borges-Nunes, 6/31 Railway Parade, Fairfield, NSW	101.76	''	28/04/00
Mrs Fernanda Mesquita Borges-Nunes, 6/31 Railway Parade, Fairfield, NSW	127.20	''	27/10/00
Malcolm John Dunlop Borland & Robyn Elizabeth Borland, PO Box 6025, South Penrith Business, South Penrith, NSW	100.00	''	''
Leonard Borrow & Mary Borrow, 48 Grove Street, Eltham	128.00	''	28/04/00
Peter Borsky, 24A The Crescent, Vacluse, NSW	169.60	''	''
Peter Borsky, 24A The Crescent, Vacluse, NSW	212.00	''	27/10/00
Anthony Boskovitz, 6 Cambridge Avenue, Vacluse, NSW	120.70	''	28/04/00

Boston Technology Corporation Pty Ltd, Po Box 7339, Cloister Square, WA	123.45	''	''
Boston Technology Corporation Pty Ltd, PO Box 7339, Cloister Square, WA	204.00	''	27/10/00
Rick Gregory Botha, 35 Julia Street, Burleigh Heads, Qld	100.00	''	''
Ms Katharine Bouffler & Mr Nigel Banks, 4 Edwin Street, Cammeray, NSW	120.00	''	''
Kelvin Thomas Bourke & Justin Thomas Bourke, 3 Vermeer Court, Grovedale	100.00	''	''
Darryl William Bourke & Kathleen Anne Bourke, 5 Adrian Court, Rockbank	100.00	''	''
Mr Alan Jeffrey Bourke & Mrs Melinda Cecily Bourke, 7 Milparinka Way, Berwick	169.60	''	28/04/00
Gail Margaret Bourne, C/- Deloitte Fin Services Ltd, Level 4, Grosvenor House, 225 George Street, Sydney, NSW	301.55	''	''
Gail Margaret Bourne, C/- Deloitte Fin Services Ltd, Level 4 Grosvenor House 225 George Street, Sydney, NSW	500.00	''	27/10/00
Alexandra Glenda-Joy Bowden & Carolyn Anne Bowden & Alexandra Glenda-Joy Bowden, 980 High Street, Armadale	100.00	''	''
Peter C. Bowden, PO Box 40938, Casuarina, NT	200.00	''	28/04/00
Peter C. Bowden, PO Box 40938, Casuarina, NT	250.00	''	27/10/00
Kathryn Bowe, "Harrison Donald Bowe A/c", PO Box 4, Tarrington	110.00	''	''
Warren Bowen, 3/43 Queen Street, Melbourne	100.00	''	''
Karen Lee Bowers & Peter William Bowers, 28/22 Ridge Street, North Sydney, NSW	120.00	''	''
Andrew Norman Bowey, 3 Arnold Place, Wodonga	160.00	''	''
Herbert James Bowles, 152 Albury Street, Harden, NSW	100.00	''	''
Gary Laurence Boyd, 13 The Fairway, Port Macquarie, NSW	100.00	''	''
Colin David Boyd & Gloria Dawn Boyd, "Force Marketing S/Fund A/c", 31 Staysail Crescent, The Moorings Robina, Qld	243.20	''	28/04/00
Shane Boyd, 30 Hillcrest Avenue, Nambour, Qld	120.00	''	''
Amanda Boyd, 12/69 Curlewis Street, Bondi Beach, NSW	140.00	''	27/10/00
Mr William Gerard Boydell, 77 Ludlow St, Chapel Hill, Qld	110.00	''	''
Robert Boykett, 4/1476 Malvern Road, Glen Iris	100.00	''	''
Susan Elizabeth Boyle & Robert David Robertson, 5/16a Charles Street, Carlingford, NSW	100.00	''	''
Nicholas Bozionelos & Georgina Perdikaris, 30 Mi Mi Street, Oatley, NSW	140.00	''	''
Ms Sylvia Braams, 47 Normanby Road, Kew	112.00	''	28/04/00
Mr Sasha William Gerrard Bracher, 4/3 Murdoch Street, Cremorne, NSW	146.90	''	27/10/00
Mrs Jodie Anne Brackenreg, 18 Armstrong Rd, Heathmont	128.00	''	28/04/00
Mr Adam Bracks, PO Box 1473, Poplar Bluff Mo 63901 USA	226.00	''	27/10/00
Barbara Laura Bradbury, PO Box 257, Quirindi, NSW	150.00	''	''
Mr Duncan Peter Bradford, 5 Anderson Street, Charters Towers, Qld	250.00	''	''
Robyn Gillies Darrin Gillies Bradii, 622 Macquarie Drive, Eleebana, NSW	118.90	''	''
Mr Arthur William Bradley, 8 Goodwin Street, Glen Iris	100.00	''	''
Keith William Brain, PO Box 576, Granville, NSW	136.65	''	28/04/00

Keith William Brain, PO Box 576, Granville, NSW	226.00	''	27/10/00
Mr Michael Clarence Braithwaite & Mrs Jennifer Anne Braithwaite, C- Whm Assetmanagement Ltd, GPO Box 385, Brisbane, Qld	120.70	''	28/04/00
Justin Braitling, 11/5 Elizabeth Bay Crescent, Elizabeth Bay, NSW	390.40	''	''
Henriette Myriam Brajtman, 76 Beresford Road, Rose Bay, NSW	317.00	''	27/10/00
Vanessa Lynne Brajtman, 76 Beresford Rd, Rose Bay, NSW	130.00	''	''
Antonetta Brancatisano, 9 Angela Court, Cranbrook, Qld	112.00	''	28/04/00
Brandamar Pty Ltd, 125 Nepean Highway, Seaford	100.00	''	27/10/00
Peter James Brasher, 20 William Street, Kingaroy, Qld	100.00	''	''
Andrew Simon Braun, 2/11 Erica Avenue, Glen Iris	100.00	''	''
William L. Bray, 11 Moss Avenue, Mount Helen	100.00	''	''
Mr Kerry John Breen, Unit 5, 232 Cotham Road, Kew	144.00	''	28/04/00
Mr Kerry John Breen, Unit 5, 232 Cotham Road, Kew	180.00	''	27/10/00
Mr Danny Dragan Brekalo, 20 Nasturtium Gardens, Beeliar, WA	100.00	''	''
Brendale Investments Pty Ltd, 30 Brendale Avenue, North Blackburn	100.00	''	''
Brenice Nominees Pty Ltd, 4 Jomary Court, Berwick	100.00	''	''
Brenine Cleaning Services Pty Limited, "Super Fund A/c", 6 Prout Place, Quakers Hill, NSW	150.40	''	28/04/00
Brennan Constructions Pty Ltd, 183 Halifax St, Adelaide, SA	160.00	''	27/10/00
Mr Thomas Patrick Brereton & Liberty Brereton, 34 Claremont Avenue, Malvern	120.70	''	28/04/00
Mr Thomas Patrick Brereton & Liberty Brereton, 34 Claremont Avenue, Malvern,	200.00	''	27/10/00
Andrew Thomas Brett, "Brett Investment A/c", 17 Stawell Road, Lower Plenty	128.00	''	28/04/00
Diana Lynne Brewer, 5 Westmeath Avenue, Killarney Heights, NSW	142.50	''	27/10/00
Brian Robert Gamble, Sandra E. Gamble, Keith G. Savory, Trustees Aurora Trust, 12 Mcbreen Avenue, Northcote Auckland, New Zealand	147.80	''	28/04/00
Brian Robert Gamble, Sandra E. Gamble, Keith G. Savory, Trustees Aurora Trust, 12 Mcbreen Avenue, Northcote Auckland, New Zealand	200.00	''	27/10/00
Mr Timothy Paul Brickhill, 4 Clyde St, North Bondi, NSW	1,094.80	''	''
Richard Bridger, 203 Bridge Road, Glebe, Nsw	288.00	''	28/04/00
Andrea Bridgewater, 448 Raglan Parade, Warrnambool	112.00	''	''
Andrea Bridgewater, 448 Raglan Parade, Warrnambool	140.00	''	27/10/00
Mr Matthew Peter Brien, 124 Port Road, Alberton, SA	100.00	''	''
Briers Investments Pty Ltd, 7 Castella Street, Ivanhoe East	100.00	''	''
Brigden Superannuation Fund Pty Ltd, 65/501 Queen Street, Brisbane, Qld	301.55	''	28/04/00
Brigden Superannuation Fund Pty Ltd, 65/501 Queen Street, Brisbane, Qld	500.00	''	27/10/00
Janice Margaret Bright, 16/11 Merlin St, Neutral Bay, NSW	207.80	''	28/04/00
Janice Margaret Bright, 16/11 Merlin St, Neutral Bay, NSW	344.00	''	27/10/00
Ms Hilda Britton, 3 Tiuna Grove, Elwood	100.00	''	''

D. J. Brockhoff & R. D. Brockhoff, "Super Fund A/c", 12 Park Street, Brighton	205.60	"	28/04/00
D. J. Brockhoff & R. D. Brockhoff, "Super Fund A/c", 12 Park Street, Brighton	257.00	"	27/10/00
Ms Simone I Brockman, 7 Tairora Street, Whalan, NSW	250.00	"	"
Elizabeth Stacey Broderick, 31 Olympic Ave, Cheltenham	100.00	"	"
Wayne Stuart Brodie, 1 Como Street, Blakehurst, NSW	108.00	"	"
Mr David A. Brokenshire, 34 Northey Court, Henley Beach, SA	100.00	"	"
Mr Graham Leslie Bromfield, 31 Spencer Street, Summer Hill, NSW	160.00	"	28/04/00
Mr Derek John Bromhead & Mr Anthony Bromhead, "Est Margaret L. Bromhead A/c", C/- Mr Anthony Bromhead, 21 Buttenshaw Drive, Coledale, NSW	140.00	"	"
Mr Derek John Bromhead & Mr Anthony Bromhead, "Est Margaret L Bromhead A/c", C/- Mr Anthony Bromhead, 21 Buttenshaw Drive, Coledale, NSW	232.00	"	27/10/00
Kerry Bronson, 2/70 West Street, Balgowlah, NSW	100.00	"	"
Christopher George Brookes, 180 Barkers Road, Hawthorn	140.00	"	"
Ms Patricia Ellen Brooks, 309 Ramsay St, Toowoomba, Qld	100.00	"	"
Gordon Brian Brooks & Kay Francis Brookers, 7 Ilawong Street, Lugaarno, NSW	100.00	"	"
Mr Scott Brotherton "Balloon Aloft A/c", Manor Farm House, Kenardington, Near Ashford, Kent TN26 2NE United Kingdom	120.70	"	28/04/00
John Phillip Broughton, 49 Myson Drive, Cherrybrook, NSW	120.00	"	27/10/00
Mr Raymond John Broughton & Mrs Cheryl Anne Broughton, Lot 33, Rigby Place, Sunbury	310.40	"	28/04/00
Sharon Brown, PO Box 132, Newport,	100.00	"	27/10/00
Eliza Jane Brown, 247 Loftus Avenue, Loftus, NSW	100.00	"	"
Ross Kevin Brown & Catherine Teresa Brown, 20 Adamson Avenue, Thornleigh, NSW	260.00	"	"
Desmond James Brown & Anna Yee-Brown, Po Box 735, Blacktown, NSW	150.00	"	"
Noel Alexander Brown, 26 Kingston Drive, Flinders View, Qld	100.70	"	"
Richard Thomas Brown & Leticia Sinfuego Brown, 6 Comino Street, Strathpine, Qld	120.70	"	28/04/00
Richard Thomas Brown & Leticia Sinfuego Brown, 6 Comino Street, Strathpine, Qld	200.00	"	27/10/00
William James Clarke Brown, 50 Philip Rd, Dalkeith, WA	181.30	"	28/04/00
William James Clarke Brown, 50 Philip Rd, Dalkeith, WA	300.00	"	27/10/00
Glynnis Brown, 36 Ritchard Avenue, Coogee, NSW	150.00	"	"
Mark Brown, 45 Yala Road, Bangor, NSW	200.00	"	"
Ms Julie Susan Cherry Brown, 2 Hexham Avenue, Myrtle Bank, SA	200.00	"	"
Mr Paul Hamilton Brown, 37 Bower Street, Manly, NSW	100.00	"	"
T.E. Rangimarie Zoline Brown & Milana Mia Milos, 4/13 Linsley Street, Gladesville, NSW	100.00	"	"
Betty Lorraine Brown, 4 Ashwin Walk, Horsham	212.00	"	"

Mr Adam Murray Brown, 26 Fraser Street, Wentworthville, NSW	200.00	''	28/04/00
Mr Christopher Mario Brown, 206/633 Church Street, Richmond	500.00	''	27/10/00
Mr David Peter Brown, 59 McMahons Rd, Ferntree Gully	300.00	''	''
Roger Lindsey Browne, 41 Simpson Ave, Forest Hill, NSW	157.05	''	28/04/00
Roger Lindsey Browne, 41 Simpson Ave, Forest Hill, NSW	260.00	''	27/10/00
Patrick Joseph Browne, 11 Templemore Avenue, Rathgar Dublin 6 Ireland	208.00	''	''
Bruce Way Motors Pty Ltd, 9 Sharp St, Matraville, NSW	120.00	''	''
Karl Brudell, 1/28 Alan Street, Cammeray, NSW	140.00	''	''
Mr Karl Brudell, Rear Block, 1/28 Alan Street, Cammeray, NSW	140.00	''	''
Mr Karl Brudell, 1/28 Alan Street, Cammeray, NSW	123.45	''	28/04/00
Mr Karl Brudell, 1/28 Alan Street, Cammeray, NSW	204.00	''	27/10/00
Gregory W. Bryce, 21 Tyalgum Avenue, Panania, NSW	146.00	''	''
Sharon Brygel, 19 Merton Street, Caulfield	100.00	''	''
Maurice Brygel, "Yael Brygel A/c", 19 Merton Street, Caulfield	100.00	''	''
Ms Li Bu, 1/24a Belmore Street, Ryde, NSW	115.00	''	''
Brett P. Bubeck, 6 Gwenmay Court, Ringwood	200.00	''	28/04/00
Brett P. Bubeck, 6 Gwenmay Court, Ringwood	250.00	''	27/10/00
Est Eileen Buchanan, 123 Archer Street, Chatswood, NSW	100.00	''	''
Sandra Buchanan, 1/13 Caramar Avenue, Brighton East	104.00	''	28/04/00
Sandra Buchanan, 1/13 Caramar Avenue, Brighton East	130.00	''	27/10/00
Mark William Buchanan, 69 Edmondstone Street, Newmarket, Qld	181.36	''	28/04/00
Mark William Buchanan, 69 Edmondstone Street, Newmarket, Qld	226.70	''	27/10/00
Mr Raymond Walter Buchanan & Mrs Coral Linda Buchanan, 15-17 Roebourne Court, Shailer Park, Qld	112.00	''	28/04/00
Sydney Buchbinder, 40 Tennyson Street, Elwood	300.00	''	27/10/00
Buchmuller Nominees Pty Ltd, 24 Hillside Crescent, Blackburn	120.00	''	''
Frances Buckeridge, PO Box 223, Jannali, NSW	208.00	''	28/04/00
Matthew Anthony Buckley, 10/1-3 Waltham Street, Coogee, NSW	110.00	''	27/10/00
Nora Buckley, 16 Liberty Stree, Stanmore, NSW	100.00	''	''
Jane Alison Buckley, 4/13 Princess Road, Nedlands, WA	192.00	''	28/04/00
Jane Alison Buckley, 4/13 Princess Road, Nedlands, WA	240.00	''	27/10/00
Stan Buckman, 10/69 Addison Rd, Manly, NSW	144.00	''	28/04/00
Stan Buckman, 10/69 Addison Rd, Manly, NSW	180.00	''	27/10/00
Buddies Australia Pty Ltd, PO Box 1636, Moorabbin	108.00	''	''
Adam Bude, 17 Castlewood Street, East Bentleigh	192.00	''	28/04/00
Budget Planners Pty Ltd, Level 3, 100 Dorcas Street, South Melbourne	120.00	''	27/10/00
Budhost Pty Ltd, "Pavuk Family Trust A/c", 33 Laycock Street, Neutral Bay, NSW	169.60	''	28/04/00
Budhost Pty Ltd "Pavuk Family Trust A/c", 33 Laycock Street, Neutral Bay, NSW	212.00	''	27/10/00

Reginald Bulner & Beryl Bulner, Tanya Mary Bulner A\C, 17 Oakland Avenue, Cloverdale, WA	100.00	”	”
Reginald Bulner & Beryl Bulner, 17 Oakland Avenue, Cloverdale, WA	100.00	”	”
Ruth Bungay, 13 Paxton Street, Malvern East,	120.70	”	28/04/00
Christopher Bunn, 121 Main Road, Thirroul, NSW	120.00	”	27/10/00
Alex Robert Bunt, 33 St Helena Parade, Eastlakes, NSW	110.18	”	28/04/00
Alex Robert Bunt, 33 St Helena Parade, Eastlakes, NSW	182.60	”	27/10/00
Alfred George Bunting & Gwyneth Evelyn Bunting, 11 Seymour Avenue, Dianella, WA	100.00	”	”
Mr Michael Anthony Bunting & Mrs Veridiana Almeida-Carvalho, PO Box 98560, Sloane Park 2152, Johannesburg, South Africa	200.00	”	”
Susan Bunworth, 8 Wenden Road, Mill Park	100.00	”	”
Irena Cvetka Burban, “Burban Super Fund A/c”, 48 Lyndale Road, Pullenvale, Qld	1,000.00	”	”
Sally Jane Burchard, 10 Rentoul Avenue, Netherby, SA	100.00	”	”
Leigh Terrence Burchat, 41 Eastwood Street, Kensington	120.00	”	”
Ms Deborah Tina Burfoot, 6 Macedon Crescent, Palmerston, ACT	100.00	”	”
David Barry Burge & Millicent Maky Burge, 6 Tristram Court, Glen Waverley	132.85	”	28/04/00
Mr Michael Joseph Burgess, 9 Goshawk Court, Leanyer, NT	100.00	”	27/10/00
Mr Peter James Burgess, “Burgess No 1 Super Fund A/c”, 20 Sagars Road, Kenthurst, NSW	120.70	”	28/04/00
Dianne Frances Burgham & Peter Rodney Burgham, 1/6-7 Gurrigal Street, Mosman, NSW	100.00	”	27/10/00
Peter Charles Burke, 165 South Creek Road, Dee Why West, NSW	100.00	”	”
Jeff Burke, 63 Maitland Road, Springfield, NSW	100.00	”	”
Derek Burke & Cecillia Burke, 79 Booran Rd, Caulfield	100.00	”	”
Burmac Pty Ltd, 127 Bridge Road, Richmond	370.00	”	”
Glen Birmingham & Merinda Birmingham, 7 Cuthbert Court, Wantirna South	120.00	”	”
Rostrevor Burnell, 6/14 Cranbrook Ave, Cremorne, NSW	100.00	”	”
Margaret B. Burnell, 6/14 Cranbrook Ave, Cremorne, NSW	100.00	”	”
Duncan Burns, 19 Kent Road, Rose Bay, NSW	217.20	”	28/04/00
Stephen C. Burns, 157 Hastings Pde, North Bondi, Sydney, NSW	400.00	”	27/10/00
Mr Warren Burns, 173 Heatherdale Road, Vermont	128.00	”	”
Mrs Suzanne Winifred Burns, 3 Wessex St, Carine, WA	350.00	”	”
Rhonda Burrows, 59 Warragoon Crescent, Attadale, WA	102.40	”	28/04/00
Burswood Electronics Pty Ltd, “Burswood Electronics A/c”, 28 Maple St, Lathlain, WA	160.00	”	27/10/00
Burswood Electronics Pty Ltd, “Burswood Electronics A/c”, 28 Maple St, Lathlain, WA	140.00	”	”
Olive Norma Burt, 11 Joy Street, Frankston	200.00	”	”
John Burton, 157 Dunbar Street, Stockton, NSW	108.60	”	28/04/00
John Burton, 157 Dunbar Street, Stockton, NSW	180.00	”	27/10/00
Anne Victoria Burton, 87 Queen Street, Woollahra, NSW	181.30	”	28/04/00

Anne Victoria Burton, 87 Queen Street, Woollahra, NSW	300.00	''	27/10/00
Mrs Barbara Margaret Bush, 4 Palm Drive, Albury, NSW	180.00	''	''
Mr Roy Peter Bushaway, C/- Jon Murphy, Serious Money, PO Box 6034 Halifax Street, Adelaide, SA	102.00	''	''
Business Computer Sys Pty Ltd, Unit 4, 1 Gwynne Street, Mount Waverley	120.70	''	28/04/00
Business Computer Sys Pty Ltd, Unit 4, 1 Gwynne Street, Mount Waverley	200.00	''	27/10/00
Kenneth Albert Butler, 22 White Cedar Close, Green Point, NSW	120.00	''	''
Jennifer Ellen Butler, 12 Montalto Avenue, Toorak	725.60	''	28/04/00
Jennifer Ellen Butler, 12 Montalto Avenue, Toorak	907.00	''	27/10/00
Bruce Leslie Butler & Georgina Lucas, 58 Campbell Street, Kensington, WA	100.00	''	''
John Ferdinand Butler, 2/17 Wentworth St, Wentworth, NSW	133.28	''	28/04/00
John Ferdinand Butler, 2/17 Wentworth St, Wentworth, NSW	166.60	''	27/10/00
Ryan James Butler, 80 Mt Pleasant Ave, Normanhurst, NSW	100.00	''	''
John Robert Buttle, 39 Lady Penrhyn Drive, Beacon Hill, NSW	342.30	''	''
Atsuko Byakuno, 41 Waterworks Road, Dynnyrne, Tas.	140.00	''	''
Mark William Byrne, 11A Spring Street, Sandringham	100.00	''	''
Mr Craig Byrne, "Dustin Byrne A/c", 5 Malcolm Court, Ringwood East	100.00	''	''
Mr Craig Byrne "Kristine Byrne A/c", 5 Malcolm Court, Ringwood East	100.00	''	''
Richard John Byrne, 7/110 Cascade St, Paddington, NSW	100.00	''	''
Ms Carolyn Byrnes, 20 Warrina Drive, Delacombe	240.00	''	28/04/00
Ms Carolyn Byrnes, 20 Warrina Drive, Delacombe	300.00	''	27/10/00
Mr Scott R. Byrnes, Po Box 13, Gravesend, NSW	250.00	''	''
Mrs Shirley Ellen Byron, 17 Grandville Street, Glenroy	100.00	''	''
Bywong Pty Ltd, 28 Allen Street, East Fremantle, WA	100.00	''	''
C. J. B. West Pty Ltd, 42 Drakeswood Rd, Warwick, WA	310.00	''	''
C. T. Pty Ltd, 658 Church Street, Richmond	4,210.00	''	''
C. T. Tan Superannuation Pty Ltd, "Ct Tan Family Super Account", 3 Bindaring Parade, Claremont, WA	840.00	''	''
C. & G. Technologies Pty Ltd, "Super Fund A/c", PO Box 479, Baulkham Hills, Nsw	104.00	''	28/04/00
Sam Caddy, 176 Balmorah Road, Port Pirie, SA	160.00	''	''
Terence Ambrose Cahalan & Nicholas John Cahalan & Therese Ellen Cahalan, 20 Bronhill Ave, East Ryde, NSW	200.00	''	27/10/00
Anne Cahill, "Rowena Susanna & Richard A/c", 42 Treatts Road, Lindfield, NSW	177.50	''	28/04/00
Anne Cahill, "Rowena Susanna & Richard A/c", 42 Treatts Road, Lindfield, NSW	294.00	''	27/10/00
Joshef Cahill, 3 Neilson Place, Footscray	160.00	''	''
Nicki Cahill, 555 Margaret Avenue, Paraburdoo, WA	100.00	''	''
Ms Anne Cahill, "Rowena Susana & Richard A/c", 42 Treatts Road, Lindfield, NSW	155.00	''	''
Chuan Cai, 13/44 Ernest Street, Lekemba, NSW	118.40	''	28/04/00
Abbey Geoffrey Caines & Jennifer Anne Caines, 1140 Gouldurn Road, Perthville, NSW	480.00	''	27/10/00

Mr Brian Thomas Caird, 2 Tui Road, Days Bay, Wellington, New Zealand	508.00	''	''
Cairnsmore Pty Limited, "DS Forbes Pension Fund A/c", C/- Rawcliffe & Associates, PO Box 636, Milsons Point, NSW	220.00	''	''
Cairnsmore Pty Ltd, "D S Forbes Pension Fund A/c", Private Box N613, Sydney, NSW	100.00	''	''
Sergio Miguel Antunes Calcarao, 296 Alfred Street, Milsons Point, NSW	128.00	''	28/04/00
Sergio Miguel Antunes Calcarao, 20/96 Alfred Street, Milsons Point, NSW	160.00	''	27/10/00
Malcolm John Calder, 70 Garden Grove Pde, Adamstown Heights, NSW	100.00	''	''
Caldor Glen Pty Ltd, "CJ Christian Pty Ltd SF A/c", 8 Harold St, Middle Park	674.82	''	28/04/00
Dianne Calistro, 7 Agg Street, Newport	100.00	''	27/10/00
Lynda A. Calistro, 167 Holland Road, Blackburn South	160.00	''	28/04/00
Josephine Calleja, 63 Greystanes Road, Greystanes, NSW	127.90	''	''
Josephine Calleja, 63 Greystanes Road, Greystanes, NSW	212.00	''	27/10/00
Ian Calley, 3/20 Leanyer Drive, Darwin, NT	100.00	''	''
Beverley Joyce Camamile, 88 Baringa St, Morningside, Qld	120.00	''	28/04/00
Anthionny Richard Camara & Michael Assi Camara, Po Box 370 29 Malley Avenue, Earlwood, NSW	224.00	''	''
Anthionny Richard Camara & Michael Assi Camara, Po Box 370 29 Malley Avenue, Earlwood, NSW	280.00	''	27/10/00
Cyril Alastair Benjamin Cameron, 11 Adelaide Street, Launceston, Tas.	100.00	''	''
Troy Cameron, 21 Alawah Avenue, Carss Park, NSW	216.00	''	28/04/00
Troy Cameron, 21 Alawah Avenue, Carss Park, NSW	270.00	''	27/10/00
Robyn Cameron, 3 Smart Street, Charlestown, NSW	192.00	''	28/04/00
Agnes Bennett Cameron, 47 Hider Street, Warrnambool	100.00	''	27/10/00
Alan Cameron, 25 Drumcliff Ave, Killarney Heights, NSW	482.35	''	28/04/00
Alan Cameron, 25 Drumcliff Ave, Killarney Heights, NSW	800.00	''	27/10/00
Tracey H. Cameron, 21 Tindale Road, Artarmon, NSW	485.00	''	''
Noel John Campbell, 5 Anka Close, Eltham	120.00	''	''
Fiona Campbell, "Kthr A/c", 11/110 Bay Rd, Waverton, NSW	100.00	''	''
Mr Martin Craig Campbell, 9 Nepean Ave, Penrith, NSW	256.00	''	28/04/00
Mr Martin Craig Campbell, 9 Nepean Ave, Penrith, NSW	320.00	''	27/10/00
Malcolm Campbell, 30 Roseberry Street, Hawthorn East	100.00	''	''
Shane A. Campbell, 2 Wiltshire Drive, Kew	157.00	''	''
Mrs Lynne Maree Campbell, 1/28 Marne Street, South Yarra	120.70	''	28/04/00
Mr Jamie Park Campbell, 39 Endeavour St, Red Hill, ACT	100.00	''	27/10/00
Candour Pty Ltd, 55/8 Birtley Place, Elizabeth Bay, NSW	301.55	''	28/04/00
Candour Pty Ltd, 55/8 Birtley Place, Elizabeth Bay, NSW	500.00	''	27/10/00
Ms Helen Canning, 111 Celtic Park Avenue, Whitehall Dublin 9, Ireland	118.24	''	28/04/00
Elizabeth Ling Cao, 40 Fernhill Street, Glen Waverley	100.00	''	27/10/00
Capegold Enterprises Pty Ltd, 1195 Hay Street, West Perth, WA	1,000.00	''	''
Raffaele Capetola, 224 Lygon Street, Brunswick	140.00	''	''
Capital (Holdings) Pty Ltd, PO Box 4, Burswood, WA	280.00	''	''

Capital Superannuation Pty Ltd, "AR Holden Wreck P/L S/F A/c", 21 Craig Hill Drive, Wheelers Hill	360.00	"	"
Caravaggio Pty Ltd, "Jules Wynhausen S/Fund A/c", 20 Glenview Street, Paddington, NSW	150.00	"	"
Domenic Carbone, "Bianca Megan Carbone A/c", 24 Lancelot Avenue, Hazelwood Park, SA	112.00	"	28/04/00
Domenic Carbone, "Carbone Family Trust A/c", 24 Lancelot Ave, Hazelwood Park, SA	112.00	"	"
Domenic Carbone, "Isabella M Carbone A/c", 24 Lancelot Avenue, Hazelwood Park, SA	112.00	"	"
Domenic Carbone, "Dion Giuseppe Carbone A/c", 24 Lancelot Avenue, Hazelwood Park, SA	112.00	"	"
Card WA Pty Ltd, 1/47 Harrison Street, Balcatta, WA	100.00	"	27/10/00
Caretaker Nominees Pty Ltd, "Woodfund Super Fund A/c", C/o Arnold Milton, 1201/1 Macquarie Place, Sydney, NSW	112.00	"	28/04/00
Brett Carey & Alexandra Carey, 35A Linton Lane, West Ryde, NSW	100.00	"	27/10/00
Est. Maxwell Charles Carey, C/- Hicks & Oakley, PO Box 2165, Mount Waverley	100.00	"	"
Garry Michael Caripis, 55 Carnarvon Drive, Frenchs Forest, NSW	100.00	"	"
Talia Carman, 10 Ferdinand Avenue, Balwyn North	308.00	"	"
Naava Carman, 10 Ferdinand Avenue, Balwyn North	240.00	"	"
Allan Thomas Carmichael, 14 Warratta Place, Oatlands, NSW	120.00	"	"
Teena Leslie Carmichael, 57 Mirrabooka Drive, Clifton Springs	240.00	"	"
R. J. Carnes & M. E. Carnes, 81 George Street, The Rocks, NSW	100.00	"	"
Lynda Joy Carnew, 24 Daphne Street, North Perth, WA	200.00	"	"
Nancy Carratelli, "Juliana Carratelli A/c", 49 Santa Rosa Boulevard, Doncaster East	100.00	"	"
Nancy Carratelli, "Carmen Carratelli A/c", 49 Santa Rosa Boulevard, Doncaster East	100.00	"	"
Nancy Carratelli, "Joel Carratello A/c", 49 Santa Rosa Boulevard, Doncaster East	100.00	"	"
Jack Carroll, 497 Ruthven Street, Toowoomba, Qld	240.00	"	"
Bernard Carroll, 3 Highbury Street, Geraldton, WA	120.70	"	28/04/00
Bernard Carroll, 3 Highbury Street, Geraldton, WA	200.00	"	27/10/00
Mr Paul Francis Carroll, 35 Holloway Drive, Everton Park, Qld	104.00	"	"
Carru Investments Pty Ltd, "Castiglia Family A/c", 1A Thomas Street, Coogee, NSW	262.65	"	28/04/00
Carru Investments Pty Ltd, "Castiglia Family A/c", 1a Thomas Street, Coogee, NSW	435.00	"	27/10/00
Carsen Pty Ltd, 5 Glenwood Road, Springfield, SA	116.20	"	"
Cartel Capital Investments Pty Ltd, C/- Hindal Corporate, Level 11, 350 Collins St, Melbourne	301.55	"	28/04/00
Valeska Carter, 2 Munster Court, Endeavour Hills	120.70	"	"
Brian Carty, 60 Jugan Street, Glendalough, WA	108.00	"	27/10/00
Brian David Carty, 235 Nicholson Street, Brunswick East	108.00	"	"
Bridgit Agnes Carver, 13/109 Penshurst Street, Willoughby, NSW	150.00	"	"

Mr Salvatore Casaceli & Mrs Agnese Casaceli, "S. & A. Casaceli S/F A/c", C/- Level 4, 115 Myers Street, Geelong	320.00	"	"
Mr Artemio Casahuilca, 4 Lilla Road, Pennant Hills, NSW	100.00	"	"
Mr Colin Arthur Case, PO Box 594, Humpty Doo, NT	176.00	"	28/04/00
Casino Investments Pty Ltd, "Ezy Super Fund Account", 96 Canterbury Street, Casino, NSW	200.00	"	27/10/00
Casio Calculator Company Pty Ltd, PO Box 7339, Cloister Square, WA	123.45	"	28/04/00
Casio Calculator Company Pty Ltd, PO Box 7339, Cloister Square, WA	204.00	"	27/10/00
Mr Paul Michael Cassano, 14 Pryor Place, Emerald Hill, NSW	100.00	"	"
Estate Brian James Cassidy & Betty Margaret Cassidy, 701/29 Yeo Street, Neutral Bay, NSW	169.60	"	28/04/00
Estate Brian James Cassidy & Betty Margaret Cassidy, 701/29 Yeo Street, Neutral Bay, NSW	212.00	"	27/10/00
Estate Brian James Cassidy, C/- Kemp Strang, Level 14, 55 Hunter Street, Sydney, NSW	212.00	"	"
Giuliana Marina Castro, 82 Davidson Ave, Concord, NSW	100.00	"	"
Hughes Catriona, 6 Nelson Street, Wooahra, NSW	257.00	"	"
Mr Ross Cattan "David & Tiffany Cattan A/c", 224 Darling Street, Balmain, NSW	100.00	"	"
Graeme John Cattanagh, 25 Ryan Street, Curtin, ACT	100.00	"	"
Mr Peter Cauchi, 3 Charles Street, Sunshine North	350.00	"	"
CBW Consulting Pty Ltd, 2 Austin Street, Footscray	100.00	"	"
Sheila Anne Cederblad & Dean Taylor Cederblad, Morgan Caravan Park, Main Road, Morgan, SA	100.00	"	"
Cee-Gee Star Pty Ltd, 187 Nelson Place, Williamstown	100.00	"	"
Barbara Celm, PO Box 38, Frankston	120.00	"	"
Elio Celotto, 20 Patterson Street, Middle Park	100.00	"	"
Domenic Cerantonio, 81 Church Street, Keilor	160.00	"	"
Andrew Joseph Ceravolo, 65 Nungerner, Balwyn	140.00	"	"
Peter Cervoni, 15 Darley Street, Shell Harbour, NSW	100.00	"	"
Dr Wee Beng Ch'ng & Dr Eileen Tumewa, "Summit Super Fund A/c", 602 Barkly Street, Footscray	100.00	"	"
Dr W. B. Ch'ng & Dr E. Tumewa, "Summit Super Fund A/c", 602 Barkly Street, Footscray West	120.00	"	"
Anthony Chadwick, C/- Patricia & Robert Chadwick, 29 Passchendaele Street, Hampton	100.00	"	"
Chris Chadwick, 20 Well Street, Brighton	100.00	"	"
Chalia Pty Ltd, PO Box 14, Fremantle, WA	100.00	"	"
Challock Pty Ltd, "R. A. Harrington S/Fund A/c", 2 Webb Street, Brighton	160.00	"	28/04/00
Challock Pty Ltd, "R. A. Harrington S/Fund A/c", 2 Webb Street, Brighton	200.00	"	27/10/00
Challock Pty Ltd, "R. A. Harrington S/Fund A/c", 2 Webb Street, Brighton	240.00	"	28/04/00
Challock Pty Ltd, "R. A. Harrington S/Fund A/c", 2 Webb Street, Brighton	300.00	"	27/10/00
Benjamin Todd Chamberlain & Brian John Chamberlain, 57 Crosby Road, Rosetta, Tas.	100.00	"	"

Dean Howard Chamberlain, 43 Leura Grove, Hawthorn East	112.00	''	28/04/00
Mr Jon D. Chamberlain, C/-World Vision, 1 Vision Drive, Burwood East	104.00	''	27/10/00
Bozena Iwulska Chambers & Michael Francis Chambers, 10 Newcastle Street, Warradale, SA	192.00	''	28/04/00
Bozena Iwulska Chambers & Michael Francis Chambers, 10 Newcastle Street, Warradale, SA	240.00	''	27/10/00
Miss Camilla Chambers, 110-1919b-Fourth Street, SW Calgary ABT251W4 Canada	100.00	''	''
Mr Erian Chambers, 110-1919b-Fourth Street, SW Calgary ABT251W4 Canada	100.00	''	''
Carolyn Chambers, 13/14 Abbott Street, Coogee, NSW	100.00	''	''
Kim Chan, PO Box 534, Kogarah, NSW	120.70	''	28/04/00
Kim Chan, PO Box 534, Kogarah, NSW	200.00	''	27/10/00
Terence Eng Hin Chan, 5/26 Dudley St, West Melbourne	100.00	''	''
Martin Chee-Mun Chan, 9/62 Bronte St, East Perth, WA	188.50	''	28/04/00
Martin Chee-Mun Chan, 9/62 Bronte St, East Perth, WA	312.00	''	27/10/00
Ingrid Chan, 6/18-22 West Crescent, McMahons Point, NSW	232.00	''	''
Linda Chan, 2/82 Wolseley Street, Bexley, NSW	163.15	''	28/04/00
Linda Chan, 2/82 Wolseley Street, Bexley, NSW	270.00	''	27/10/00
Po Yi Chan, 22 Lauer Street, Doncaster	181.30	''	28/04/00
Ronald Chan, 8 Retimo Close, St Ives, NSW	150.00	''	27/10/00
Tze Swee Chan, Unit 1, 1 Rosstown Road, Carnegie	120.00	''	''
Eric Chi Lik Chan, "Glenn Cheung Fai Chan A/c", 6 Barrie Street, Killara, NSW	100.00	''	''
Vivian Chan, PO Box 211, Hunters Hill, NSW	100.00	''	''
William Chan, PO Box 211, Hunters Hil, NSW	100.00	''	''
Tak Chan, C/- Swee Tock Chew, 32 Grandview Grove, Moorabbin	106.00	''	''
Ms Freda Chan, "Mandy Ng A/c", Unit 6A, 300 Marsden Road, Carlingford, NSW	100.00	''	''
Freda Chan, "Joyce Ng A/c", Unit 6A, 300 Marsden Road, Carlingford, NSW	100.00	''	''
Mr Colin Chan, 27 Keda Circuit, North Richmond, NSW	114.00	''	''
Miss Mee Lian Chan, 236 Farnham Rd, Quakers Hill, NSW	100.00	''	''
Mr Kwai Fong Chan & Mr Ken Fong Chan & Ms Mary Elizabeth Tan, "Cactus Family A/c", 5 Little Street, Glen Waverley	680.00	''	''
Mr Stephen David Chance, 38 Raymond Street, Mount Pleasant, WA	1,024.15	''	28/04/00
Swaras Chand, "Shaneel Chand A/c", 38 Dean Street, Strathfield South, NSW	100.00	''	27/10/00
Huai Ngin Chang, 18 Maling Road, Canterbury	100.00	''	''
May Ling Chang, 164 Churchill Avenue, Braybrook	120.00	''	''
Sin Wei Chang, PO Box 131, Carnegie	160.00	''	''
Yew Ling Chang, 18 Maling Road, Canterbury	135.00	''	''
Mee Yong Chang, 2 Brae Court, Eltham North	302.00	''	''
Yvonne Chang & Emily Chang, 95 Station Street, Petersham, NSW	150.00	''	''
Sheau Chang, 2 Brae Court, Eltham	100.00	''	''
Yut Fok Chang, 2 Brae Court, Eltham	100.00	''	''
Chi Min Chang, 107/192 Vimiera Road, Marsfield, NSW	100.00	''	''
Ian Edward Chanter, 4 Aster Court, Mount Waverley	100.00	''	''

Chantilly Pty Ltd, PO Box 137, Croydon	176.00	''	28/04/00
Chantilly Pty Ltd, PO Box 137, Croydon	220.00	''	27/10/00
Mr John Robert Chantrell, 27 Brisbane Street, Bondi Junction, NSW	120.70	''	28/04/00
Barry Raymond Chaplin, 109 Rothschild Avenue, Rosebery, NSW	108.00	''	27/10/00
Leonie Theresa Chapman & Barry John Chapman, 2 Starling Street, Lilyfield, NSW	120.00	''	''
Peter Chapman, 17 O'Briens Road, Hurstville, NSW	300.00	''	''
Alan David Chapman, 7 Henning Road, Raymond Terrace, NSW	200.00	''	''
Roger Henry Chapman, 14 Fred Street, Lilyfield, NSW	160.00	''	28/04/00
Roger Henry Chapman, 14 Fred Street, Lilyfield, NSW	200.00	''	27/10/00
Mr Steven Charles Chapman, 17 O'Briens Road, Hurstville, NSW	100.00	''	''
Mr Geoffrey Raymond Chapman, PO Box 346, Castletown, Hyde Park, Qld	320.00	''	27/10/00
Savvas Charalambous & Imgard Charalambous, 20 Charles Street, Aitkenvale, Qld	100.00	''	''
Alexander S Charalambous, 19 Coronation Street, Mount Waverley	160.00	''	''
Mr Robert B. Charlton, Telstra Multimedia Pty Ltd, Level 9, 157 Walker Street, North Sydney, NSW	112.88	''	28/04/00
Mr Robert B Charlton, Telstra Multimedia Pty Ltd, Level 9, 157 Walker Street, North Sydney, NSW	186.60	''	27/10/00
Russell Cecil Chase, 2/3 Murray Street, Gladstone, Qld	120.00	''	''
Chase Consulting Esp Pty Ltd, Cecil St, South Melbourne	1,160.00	''	''
Alison Helene Chaston, 1319 Reserve Creek Road, Reserve Creek, NSW	100.00	''	''
Ms Jennifer Dorothy Chatfield, 2/7 Eamon Court, Kew	100.00	''	''
Chatham Pastoral Co Pty Ltd, 3/37 Morton Street, Wollstonecraft, NSW	247.00	''	''
Pramila Chaturvedi & Rajeev Chaturvedi, 5/11 Flinders Street, Wollongong, NSW	100.00	''	27/10/00
Vincent Jeet Chaudhary, 18 Imlay Ave, Carlingford, NSW	163.20	''	28/04/00
Vincent Jeet Chaudhary, 18 Imlay Ave, Carlingford, NSW	204.00	''	27/10/00
Mrs Shagufta Nargis Chaudhry, 29 Rotary Street, Liverpool, NSW	100.00	''	''
Mrs Shagufta Nargis Chaudhry, "Iffat & Farah & Sadia Chaudhry A/c", 29 Rotary Street, Liverpool, NSW	104.00	''	''
Mrs Shagufta Nargis Chaudhry, "Saleh & Sohaib Chaudhry A/c", 29 Rotary Street, Liverpool, NSW	100.00	''	''
Marc Cheah, 31 Bellotti Avenue, Winston Hills, NSW	100.00	''	''
Mrs Rajdeep Kaur Cheema & Mr Kanwarpreet Singh Cheema, Unit 2, 15 Westerham Street, Taringa, Qld	120.70	''	28/04/00
Mrs Rajdeep Kaur Cheema & Mr Kanwarpreet Singh Cheema, Unit 2, 15 Westerham Street, Taringa, Qld	140.00	''	27/10/00
Mrs Margaret Lesley Chegwyn, Unit 10, 1 Lower Boyle Street, Mosman, NSW	603.10	''	28/04/00

Yiju Chen, 21 Falaise Place, Sunnybank Hills, Qld	100.00	''	27/10/00
You Kang Chen, 27 Lidbury Street, Berala, NSW	120.00	''	''
Susan Chen, 37 Bushlands Avenue, Gordon, NSW	200.00	''	''
Liefeng Tony Chen, Flat 160, 1/F Block B, Ming Yuen Mansions, (Phase 2), 26-72 Peacock Road, North Point	100.00	''	''
Pai-Lin Chen, Unit 5008, 343 Pitt Street, Sydney, NSW	120.00	''	''
Mr Xia Ping Chen, PO Box 628, Marrickville, NSW	120.00	''	''
Mr Qian Chen, 24 Birchgrove Crescent, Templestowe	100.00	''	''
Siew-Boon Cheng, 198/25 Best Street, Lane Cove, NSW	200.00	''	''
Tien Pole Cheng, 26 Eagle Circuit, Kambah, ACT	256.00	''	28/04/00
Tien Pole Cheng, 26 Eagle Circuit, Kambah, ACT	320.00	''	27/10/00
Sook Kan Tam Cheng, 26 Eagle Circuit, Kambah, ACT	256.00	''	28/04/00
Sook Kan Tam Cheng, 26 Eagle Circuit, Kambah, ACT	320.00	''	27/10/00
Shao-Wei Cheng, 5f Alley 7, Lane 181, 23 Chung Hsiao E Road, Section 4 Taipei 106	160.00	''	''
Dr James Richard Chenoweth & Mrs Barbara Jane Chenoweth, "Chenoweth Superfund A/c", Myrniong, Moorwatha Road, Hoelong, NSW	200.00	''	''
Amy Cheong, 27 Essex Street, Epping, NSW	100.00	''	''
Lucy Cheong, 1402/2 Marcus Clarke Street, Capitol Tower, Canberra City, ACT	320.00	''	''
Daisy Cheong, 93a Middle Harbour Road, Lindfield, NSW	100.00	''	''
Mr Peter D Cheong, PO Box 63, Bond University, Qld	100.00	''	''
Mr Aubrey B Cheong, PO Box 63, Bond University, Qld	100.00	''	''
Michael Alexander Chernov, 20 Domain Street, South Yarra	100.00	''	''
Aparna Cheruvu, 1/26 Lillimur Road, Ormond	200.00	''	''
David I. Cheshire, RMB 1490, Wangaratta	160.00	''	''
Betty D .Cheshire, RMB 1490, Wangaratta	150.00	''	''
Mr Jon Cheshire, 4 Bourke Street, Woolloomooloo, NSW	140.00	''	''
Lynette Kaky Chesterton, 35 Blytheswood Avenue, Warrawee, NSW	328.00	''	28/04/00
Ms Ivy Cheung, 62 Peppermint Grove, Knoxfield	100.00	''	27/10/00
Mr Tai Wai David Cheung, PO Box 321, Doncaster Westfield Shopping Centre, Doncaster	108.00	''	''
Elly Chew, 198/25 Best Street, Lane Cove, NSW	200.00	''	''
Jasmine Lee Siang Chew & Steven Lian Hock Chew, 2 Troon Cove, Connolly, WA	100.00	''	''
Juliana Chew, 5 Lyndal Close, Doncaster East	108.00	''	''
Charlie Chi & Jimmy Chi & Hsiu-Hsia Liu, 62 Woodward Avenue, Strathfield, NSW	235.35	''	28/04/00
Charlie Chi & Jimmy Chi & Hsiu-Hsia Liu, 62 Woodward Avenue, Strathfield, NSW	390.00	''	27/10/00
Cynthia Chia, 73 Koola Avenue, East Killara, NSW	144.95	''	28/04/00
Cynthia Chia, 73 Koola Avenue, East Killara, NSW	240.00	''	27/10/00
David Chiang, 67 Carrington Road, Wahroonga, NSW	176.00	''	28/04/00
Warren Neil Chick, PO Box 25, Summerland Point, NSW	100.00	''	27/10/00
Chickenfeed Super Fund, 69 Currey Rd, Wongawallan, Qld	169.00	''	''
Kim Chien, Po Box 477, Pacific Fair, Qld	160.00	''	''
Ming Chien, 31 Breeana Court, Mudgeeraba, Qld	157.05	''	28/04/00
Ming - Hui Chien & Ming - Ching Chien, 31 Breeana Court, Mudgeeraba, Qld	150.00	''	27/10/00

Mr Jack Bingham Child & Mrs Maren Elizabeth Child, 64 Woolner Cct, Hawker, ACT	400.00	''	28/04/00
Chiltern Towns Pty Ltd, 46 Murrumbidgee Drive, Echuca	100.00	''	27/10/00
Wai Lam Chim, 31 Stringer Road, Kellyville, NSW	120.70	''	28/04/00
Wai Lam Chim, 31 Stringer Road, Kellyville, NSW	200.00	''	27/10/00
Magdalene Chim, 31 Stringer Road, Kellyville, NSW	120.70	''	28/04/00
Magdalene Chim, 31 Stringer Road, Kellyville, NSW	200.00	''	27/10/00
Linda Chin & Wen-Hsien Chin, PO Box 61, Glenfield, NSW	120.70	''	28/04/00
Linda Chin & Wen-Hsien Chin, PO Box 61, Glenfield, NSW	200.00	''	27/10/00
Mr Mattes Chionchio & Mrs Pam Chionchio, 34 Mark Road, Rossmore, NSW	600.00	''	''
Chisbury Pty Ltd, Tok Corporate Centre, Level 1, 459 Toorak Road, Toorak	224.00	''	28/04/00
Chisbury Pty Ltd, Tok Corporate Centre, Level 1, 459 Toorak Road, Toorak	280.00	''	27/10/00
Ka Pik Chiu, 60 Headland Road, Castle Cove, NSW	176.35	''	28/04/00
Ka Pik Chiu, 60 Headland Road, Castle Cove, NSW	292.00	''	27/10/00
Bee Kek Chng & Hon King Wong, 33 Warrington Avenue, East Killara, NSW	360.00	''	''
Kai Hing Cho, 9 Hamilton Street, Home Bush, NSW	128.00	''	''
Chulwon Choi, 1702/127 Kent Street, Sydney, NSW	127.90	''	28/04/00
Chulwon Choi, 1702/127 Kent Street, Sydney, NSW	212.00	''	27/10/00
Peter Chu Ching Chong, 12/22 Henley Road, Homebush West, NSW	100.00	''	''
Margaret Chow, 2 Chestnut Court, Doncaster East	160.00	''	28/04/00
John Chow, 3/3 Rocklands Road, Wollstonecraft, NSW	200.00	''	27/10/00
Mr Charles Wing Sang Chow, Flat D 35/F, Tower 5 Tierra Verde, Tsing Yi, Hong Kong	300.00	''	''
Chun Hong Choy, 1007 Fifteenth Avenue, Rossmore, NSW	217.20	''	28/04/00
Chun Hong Choy, 1007 Fifteenth Avenue, Rossmore, NSW	360.00	''	27/10/00
Catherine Choy, 801/350 Latrobe Street, Melbourne	100.00	''	''
Nick Christ, 19/18 Knocklayde Street, Ashfield, NSW	128.00	''	28/04/00
George Emmanuel Christianos & Kirstyan Lisette Christianos, "Georgia E Christianos A/c", PO Box 818, Kensington, NSW	100.00	''	27/10/00
Hyland Charles Christopher, 8 Jefferies Place, Prairiewood, NSW	140.00	''	27/10/00
Samantha Sung Ngo Chua, 1/433 Glynburn Rd, Leabrook, SA	132.85	''	28/04/00
Samantha Sung Ngo Chua, 1/433 Glynburn Rd, Leabrook, SA	220.00	''	27/10/00
Zulaikha Djannah Chudori, 12 Barrallier St, Griffith, ACT	120.00	''	''
Mr Wong Kong Chue, C/- Montagu Pty Ltd, Po Box Z500, 5 Perth St Georges Tce, WA	1,205.70	''	28/04/00
Amelia Chun & Tony Lee, 41 Union St, Kogarah, NSW	392.00	''	27/10/00
John Graeme Church, 20 Hillcrest Road, Warrandyte South	168.00	''	''
Michelle Ciavarella, 38 Ferndale Road, Sunshine	134.40	''	28/04/00
Michelle Ciavarella, 38 Ferndale Road, Sunshine	168.00	''	27/10/00
Carlos Cid, 333 Pinjarra Road, Pinjarra Hills, Qld	100.00	''	''
Mrs Anna Cimino, Po Box 2106, Rowville	100.00	''	''
Mr Sam Paul Cimino & Mrs Rosetta Ann Cimino, 11 Kitchener Road, Pascoe Vale	100.00	''	''
Joe Cirillo & Ann Cirillo, 1/23 Shephardson, Isaacs, ACT	100.00	''	''
City View Plumbing Services Pty Ltd, "TLC Super Fund A/c", Unit 9, 28 Holland Crescent, Capalaba, Qld	100.00	''	''

City View Plumbing Services Pty Ltd, "Lachnick S/F A/c", 6 Bergin Creek Road, Bunya, Qld	110.00	"	"
City View Plumbing Services Pty Ltd, "TLC Superannuation Fund A/c", Unit 9, 28 Holland Crescent, Capalaba, Qld	200.00	"	"
Saveria Ciurleo, 145 Glasgow Avenue, Reservoir	108.00	"	"
CK Clothing Pty Ltd, 13-17 Hillwin Street, Reservoir	272.00	"	"
CI Pty Ltd, "CI Family A/c", 2 Marana Road, Northbridge, NSW	500.00	"	"
CL Pty Ltd, "C L Family Account", 2 Marana Road, Northbridge, NSW	188.00	"	"
Clairette Pty Limited, C/- BMF Investment Services P/L, Level 53, MLC Centre, 19 Martin Place, Sydney, NSW	164.00	"	"
Daniel Clancy, 6 Grove Road, Rosanna	100.00	"	"
Leonie Alice Clare & Cyril Dennis Clare, 4/5 Marmion Road, Abbotsford, NSW	100.00	"	"
Susan Elizabeth Clare, 25 Illoura Ave, Wahroongah, NSW	723.80	"	28/04/00
Susan Elizabeth Clare, 25 Illoura Ave, Wahroongah, NSW	1,200.00	"	27/10/00
Jonathan Peter Clare, 25 Illoura Avenue, Wahroonga, NSW	200.00	"	"
Ms Deborah Ann Clark, 8/10 Gordon Ave, Chatswood, NSW	100.00	"	"
Nicholas Paul Clark, RMB 265, Clarks Road, Waubra	120.00	"	28/04/00
Nicholas Paul Clark, RMB 265, Clarks Road, Waubra	150.00	"	27/10/00
Mr Graeme Clark & Ms Desley Haas, 5 Lyne Street, Alexandria, NSW	108.00	"	"
Ian Andrew Clark & Chanelle Louise Mcclure, 14 Alexander Avenue, Roma, Qld	100.00	"	"
Mr Benjamin John Clark & Miss Marnie Maree Clark, 7 Harper Place, Mill Park	100.00	"	"
Mary Clark, "Winslow A/c", 3 Toorak Road, South Yarra	100.78	"	28/04/00
Mary Clark, "Winslow A/c", 3 Toorak Road, South Yarra	166.60	"	27/10/00
Thomas John Clarke & Berniece Bridget Clarke, 80 Hunter Avenue, St Ives, NSW	220.00	"	"
Mr Robert Alexander Clarke, 66 Cutler Rd, Clontarf, NSW	130.00	"	"
Richard Clarke, CM Pacific Hwy & Terran, Banora Point, NSW	220.00	"	"
Peter Clarke, 70 Noorong Street, Barham, NSW	100.00	"	"
Lauris Clarke & Gavan Clarke, 32 Grandview Road, Pullenvale, Qld	120.00	"	28/04/00
Catherine Marjorie Clarke, 35 Park Drive, Parkville	168.00	"	27/10/00
Mr Peter Clarke & Mrs Susan Watts, "Essex Super Fund A/c", 60 Steeles Creek Rd, Yarra Glen	100.00	"	"
Mr John Edwin Alfred Clarke, 34 Octantis Street, Coorparoo, Qld	150.00	"	"
Est Noel Clarke, C/- Matthew Glossop & Assoc, 20 Beechboro Road, Bayswater, WA	150.00	"	"
Clarke & Dipauli Pty Ltd, "Dipauli Super Fund A/c", PO Box 88, Queanbeyan, NSW	210.00	"	"
Nathan R. Claxton, 234 Bayswater Road, Bayswater North	500.00	"	"
Pamela Clearwater, PO Box 872K, Melbourne	105.55	"	28/04/00
Pamela Clearwater, PO Box 872K, Melbourne	175.00	"	27/10/00
Cleary Construction Pty Ltd, "Cleary Super Fund Account", 6 Arden Court, Hillarys, WA	120.86	"	28/04/00
Mrs Olive Clegg, 15 Yallambee Way, Croydon, NSW	212.33	"	"

Mrs Olive Clegg, 15 Yallambee Way, Croydon, NSW	352.10	''	27/10/00
Colin Raymond Cleversley & Sherylee Therese Cleversley, 18 Winston Street, Yarragon	140.00	''	''
Wayde Peter Clews & Cherylynne Mae Clews, 90 Nelson Road, South Melbourne	100.00	''	''
James Dennis Clifford, 2 Cumming Place, Wanniasa, ACT	240.00	''	28/04/00
Cliffside Nominees Pty Ltd, 27 McMahens Rd, Bangholme	100.00	''	27/10/00
Mr John Ronald Closter, 62 Dickson St, Bacchus Marsh	100.00	''	''
Ms Teresa Clough, 10 Cyril Street, Ashburton	100.00	''	''
Brian Clouston & Kathleen Sheilah Clouston, 74/1 Moore Street, Taringa, Qld	200.00	''	''
Ms Elisabeth Gail Clout, PO Box 152, Noosaville, Qld	100.00	''	''
Club 1001 Pty Limited, Unit 5R, 27-31 William Street, Botany, NSW	440.45	''	28/04/00
Michael John Clutterbuck, PO Box 324, Buddina, Qld	100.00	''	27/10/00
Cng Australia Pty Ltd, 21 Drummond Place, Carlton	200.00	''	''
Winifred Hannah Coad, Ocean Gardens, 9/60 Kalinda Drive, City Beach, WA	120.70	''	28/04/00
Winifred Hannah Coad, Ocean Gardens, 9/60 Kalinda Drive, City Beach, WA	200.00	''	27/10/00
Glenn Desmond Coad, 5 Gordon Grove, South Yarra	100.00	''	''
Brenda Margaret Coatalen, PO Box 2173, Clovelly West, NSW	120.70	''	28/04/00
Mr Nathan Coates & Coates Brothers, C/- Alan Coates, 42 Young Street, Waterloo, NSW	240.00	''	27/10/00
Isabel Joy Coburn, 205 Drummond Street Nort, Ballarat	100.00	''	''
Charles David Coburn, 205 Drummond Street Nort, Ballarat	100.00	''	''
Raymond Cociolone, 55 Red Chapel Ave, Sandy Bay, Tas.	160.00	''	''
Maria Cochrane, 21 Clifton Street, Essendon	120.00	''	28/04/00
Peter Cochrane, 6 Rivers Street, Bellevue Hill, NSW	150.00	''	27/10/00
Helen Cocks, 379 Wattle Tree, East Malvern	120.00	''	''
Mrs Joann Narelle Cocks, 73a Garland Rd, Naremburn, NSW	100.00	''	''
Cocodon Pty Limited, 47 Garnet Street, Dulwich Hill, NSW	100.00	''	''
Cheryl Coe, 6 Milborne Crescent, Eltham	110.00	''	''
William A Coe & Faye E. Coe & "Super Fund A/c", PO Box 353, Miranda, NSW	243.35	''	28/04/00
William A. Coe & Faye E. Coe & "Super Fund A/c", PO Box 353, Miranda, NSW	403.00	''	27/10/00
Mr David Coelho, "Donald Michael Coelho A/c", 3 Middle Road, Camberwell	160.00	''	28/04/00
Martina Coffey & Christopher Crowley, Unit 14, 9 Brentham Street, Leederville, WA	100.00	''	27/10/00
Catherine Coffey, 10 Redesdale Rd, Ivanhoe	100.00	''	''
Mr Maurice Coffey, Unit 8, 19-21 Tintern Road, Ashfield, NSW	100.00	''	''
Cogent Pty Ltd, Petroleum House, 1/3 Brodie Hall Drive, Bentley, WA	108.00	''	''
Paul Cohen, 53 Lambeth Street, Panania, NSW	280.00	''	''
Paul Cohen, 1 Brisbane Avenue, Umina, NSW	169.20	''	28/04/00
Desmond Cohen, 1 Brisbane Avenue, Umina Beach, NSW	169.20	''	''
Desmond Cohen, 53 Lambeth Street, Panania, NSW	280.00	''	27/10/00
Jennifer Anne Cok, 36 Karangi Road, Whalan, NSW	112.00	''	28/04/00
Col-Tec Pty Ltd, 103 Riaweena Street, The Gap, Qld	327.00	''	27/10/00

Margaret Sophia Colbron, 7 Hillside Rd, Blackwood, SA	100.00	''	''
Michael James Colbron, 7 Hillside Road, Blackwood, SA	100.00	''	''
Mr Gordon M. Cole, 36/154 Subiaco Road, Subiaco, WA	200.00	''	28/04/00
Patricia Coleiro, "Renee Coleiro A/c", 240A Union Rd, Surrey Hills	150.00	''	27/10/00
Patricia Coleiro, 240A Union Road, Surrey Hills	300.00	''	''
Peter James Coleman, Unit 1, 20 Northcote Street, Wollongong, NSW	\$112.00	''	28/04/00
Mark Hugh Coleman, "Super Fund A/c", 91 Allinga Avenue, Glenunga, SA	100.00	''	27/10/00
Ian David Coleman, 3 Pearl Bay Avenue, Mosman, NSW	100.00	''	''
Mr Darren Coleman, 14 Simpson Street, South West Rocks, NSW	110.00	''	''
Gilbert Edgar Coles & Ian David Bloodworth, Private Box N613, Grosvenor Place, NSW	240.00	''	''
Mr Mak Coles, C/- KPMG, PO Box 22914, Melbourne	135.85	''	28/04/00
Mr Mak Coles, C/- KPMG, PO Box 22914, Melbourne	225.00	''	27/10/00
Ms Caterina Colleluori, 295 Jells Road, Mulgrave	100.00	''	''
John Gary Collins, 7 Keeler Street, Carlingford, NSW	100.00	''	''
Sarah Corinne Collins, 1/6 Bromley Avenue, Cremorne Point, NSW	140.00	''	''
Louise Mary Collins, 2 Dalsten Grove, Mount Eliza	100.00	''	''
Louise Mary Collins & Anthony John Collins, 2 Dalsten Grove, Mt Eliza	100.00	''	''
Lois Anne Collins, Ridgway Street, Childers, Qld	140.00	''	''
Mr Greg Joseph Collins, 12 Rivergum Place, Fig Tree Pocket, Qld	360.00	''	''
Mr William Collins, 6/15 Victoria Avenue, Penshurst, NSW	151.00	''	28/04/00
Mr Michael Richard Collins & Mr Sam Leo Radici, Unit 21, 26 Stanley Street, Mount Lawley, WA	180.00	''	27/10/00
Colorisation Pty Ltd, PO Box 1045, Alice Springs, NT	140.00	''	''
Colors Investment Management Pty Ltd, Ground Level, 161 Collins Street, Melbourne	400.00	''	28/04/00
Colors Investment Management Pty Ltd, Ground Level, 161 Collins Street, Melbourne	500.00	''	27/10/00
Ms Leanne Patricia Colson, 23 Monterey Crescent, Donvale	120.00	''	28/04/00
Dell Colwell, 25 London Road, Clayfield, Qld	241.45	''	''
Mr Basil Jim Combis, Unit 4, 511 Vulture Street, East Brisbane, Qld	320.00	''	27/10/00
Commercial Nominees of Australia Ltd, "High Trees S/F A/c", C/- Ms Jennifer Heath, Neutral Bay, NSW	100.00	''	''
Kathleen Mary Commins, Mr C. Mund, C/-66 Johnson Street, Chatswood, NSW	177.28	''	28/04/00
Mr John Christopher Compton, 44 Macgregor Street, Rockhampton, Qld	192.00	''	''
Brian Compton, 51 Arinya St, Kingsgrove, NSW	162.00	''	''
Brian Compton, PO Box 176, Kings Grove, NSW	162.00	''	''
Mr Brian P. Compton, Level 2, 400 George Street, Sydney, NSW	132.85	''	''
Paul Jeffrey Conaghan, 67 Kingfisher Parade, North Rockhampton, Qld	160.00	''	27/10/00

Concept Vision Pty Ltd, 15 Applegum Grove, East Doncaster	120.00	''	''
Paul Condell, CMC, GPO Box 560, Suva, Fiji	232.00	''	''
Michael Condoleon, 26 Woodlands Rd, Taren Point, NSW	120.00	''	''
Brett Stanley Condon, "Ashleigh Marina Condon A/c", 43 Glenhope Road, Pennant Hills West, NSW	140.00	''	''
Brett Stanley Condon, "Adam Thomas Condon A/c", 43 Glenhope Road, Pennant Hills West, NSW	140.00	''	''
Susanne Condos, 1 Dongola Road, Keilor Downs	240.00	''	''
Condra 21 Pty Ltd, 19 Shordley St, West Chermshire, Qld	120.00	''	''
Mr Malcolm John Condron, Unit 5/31 Mulgrave Street, Spring Hill, Qld	675.00	''	''
Est John Cyril Conley, C/- Alexanders, PO Box 756, Maroubra Junction, NSW	100.00	''	''
Paul Antony Conn, 2/92 Mount Street, Coogee, NSW	157.05	''	28/04/00
Paul Antony Conn, 2/92 Mount Street, Coogee, NSW	260.00	''	27/10/00
Ms Jennifer Marie Conn, 119 Stoney Creek Road, Upper Beaconsfield	140.00	''	''
John Irwin Connal, 20 Maria Street, Petersham, NSW	100.00	''	''
Estate Leo Paul Connellan, C/- Mr G Connellan, 372 Main Road, Lower Plenty	201.60	''	28/04/00
Estate Leo Paul Connellan, C/- Mr G Connellan, 372 Main Road, Lower Plenty	252.00	''	27/10/00
Elizabeth Connor, 11 Elizabeth Street, Mayfield, NSW	200.00	''	''
Geoff Connor, 6 Webb Place, Blign Park, NSW	100.00	''	''
Stephen Connor, 1/51 Kenilworth Road, Parkside, SA	100.00	''	''
Stephen Connor, Lv/70 Hindmarsh Square, Adelaide, SA	100.00	''	''
Dennis O'Connor, 20 Cumming Avenue, Birchip	100.00	''	''
Duane Patrick O'Connor, 21 Stephenson St, Wulguru, Qld	144.95	''	28/04/00
Duane Patrick O'Connor & Mark James O'Connor, 21 Stephenson Street, Wulguru, Qld	144.95	''	''
Mark James O'Connor, 21 Stephenson Street, Wulguru, Qld	144.95	''	''
Conserv Pty Ltd, 444 City Road, Southbank	100.00	''	27/10/00
Mrs Elissa Constable, Mr Haydn Constable, 87 Mitchell Street, Stockton, NSW	100.00	''	''
George Constantinescu, 1/99 MacKinnon Parade, North Adelaide, SA	100.00	''	''
Ian Russell Construction, "Super Fund A/c", 10 Mayfield Avenue, Malvern	115.00	''	''
Lomax Consultants "Superannuation Fund", 486 George Street, Fitzroy	460.00	''	''
Peter Conte & Marianne Conte, 45 Wellington St, Coburg	100.00	''	''
Peter Contencin & Yvonne Contencin, 20 Springfield Drive, Narre Warren	100.00	''	''
Linda Convery, 31 Kardinia Drive, Yallambie	160.00	''	28/04/00
Linda Convery, 31 Kardinia Drive, Yallambie	200.00	''	27/10/00
Joshua Convery, 31 Kardinia Drive, Yallambie	160.00	''	28/04/00
Joshua Convery, 31 Kardinia Drive, Yallambie	200.00	''	27/10/00
Bernard Convery, 31 Kardinia Drive, Yallambie	160.00	''	28/04/00
Bernard Convery, 31 Kardinia Drive, Yallambie	200.00	''	27/10/00
Nicole Ann Conway, 53 Williamsons Road, Doncaster	160.00	''	27/10/00
Kevin Conway, 8 Foster Place, Griffith, NSW	151.00	''	28/04/00
Kevin Conway, 8 Foster Place, Griffith, NSW	250.00	''	27/10/00

Richard Cook & Michelle Anger, 3/29 Ocean Avenue, Double Bay, NSW	100.00	''	''
Phillip Charles Cook, 9 Cedardale Way, Safety Bay, WA	144.95	''	28/04/00
Phillip Charles Cook, 9 Cedardale Way, Safety Bay, WA	240.00	''	27/10/00
Paul William Gilbert Cook & Estate Dorothy Cook, 18 Chipping Road, City Beach, WA	100.00	''	''
Mr Michael Cook, Unit 8, 26–28 Melrose Parade, Clovelly, NSW	457.60	''	28/04/00
Mr Norman Leslie Cook, 40 Morehead Avenue, Mount Druitt, NSW	120.70	''	''
Amanda Susan Cook, 1/1b Whateley Street, Newtown, NSW	144.95	''	''
Amanda Susan Cook, 1/1b Whateley Street, Newtown, NSW	240.00	''	27/10/00
Anne Cook, 46 Louisa Road, Birchgrove, NSW	301.55	''	28/04/00
Anne Cook, 46 Louisa Road. Birchgrove, NSW	500.00	''	27/10/00
Peter James Cook, 19 Douglas Street, Stanmore, NSW	100.00	''	''
Michael Cooke, 204 Talbot St, Ballarat	100.00	''	''
Peter C. Cooke, 80 Bellata Street, The Gap, Qld	169.60	''	28/04/00
Peter C. Cooke, 80 Bellata Street, The Gap, Qld	212.00	''	27/10/00
Estate Abram Coombes & Barbara Phyllis Coombes, Villa 316, Bayview Gardens, Bayview, NSW	152.00	''	28/04/00
Livinia Clare Coombes, 18 Quartersession Road, Westleigh, NSW	100.00	''	27/10/00
Mr Jesse Lee Coombs, 14 Sullivan St, Somerton Park, SA	140.00	''	''
James Lawrence Coomes, "Belinda Louise Coomes A/c", 34 Chaucer Crescent, Canterbury	255.00	''	''
Peter Thomas Cooney, PO Box 5173, SCMC Mail Centre, Nambour, Qld	100.00	''	''
Peter Cooney, "Balvenor S Fund A/c", PO Box 3173, Nambour, Qld	260.00	''	''
Ashton Cooper & Traciee Cooper & Joshua Cooper & Erinn Cooper, 29 D'Arbon Avenue, Singleton Height, NSW	100.00	''	''
David Cooper, 8 Plaister Court, Sandy Bay, Tas.	100.00	''	''
Daniel Edward Cooper, 10a Bowen Street, Kensington, SA	100.00	''	''
Andrea Austin Cooper, "Childrens Account", 61 Campbell Road, East Hawthorn	137.80	''	28/04/00
Andrea Austin Cooper, "Children's Account", 61 Campbell Road, East Hawthorn	228.00	''	27/10/00
B. W. Cooper, PO Box 36A, Mount Waverley	100.00	''	''
Timothy Cooper, PO Box 36, Jamestown, SA	100.00	''	''
Mr Justin Heath Cooper, 45 Mitcham Avenue, Lower Mitcham, SA	240.00	''	28/04/00
Kithsiri Alex Cooray, "Kac Holdings Pty Ltd A/c", PO Box 9063, Scoresby	160.00	''	''
Kithsiri Alex Cooray, "Kac Holdings Pty Ltd A/c", PO Box 9063, Scoresby	200.00	''	27/10/00
Ms Emma Patricia Coote, PO Box 67, Narromine, NSW	100.00	''	''
Mr Richard Montgomery Coote, PO Box 5663, Mackay, Qld	320.00	''	28/04/00
Mr Richard Montgomery Coote, PO Box 5663, Mackay, Qld	400.00	''	27/10/00
Wesley Allen Copeland, PO Box 227, Dongara, WA	200.00	''	''
Copper Beautiful One Pty Ltd, 301/30 Buckland Street, Chippendale, NSW	108.00	''	''

Gerard Corbett, 2 Finuge Court, Victoria Point, Qld	100.00	''	''
Stephen Corbett, 4/31 Gordon Street, Manly Vale, NSW	120.70	''	28/04/00
Stephen Corbett, 4/31 Gordon Street, Manly Vale, NSW	200.00	''	27/10/00
Mr David William Hugh Corbin, 4/1 Childers Rd, Malvern	100.00	''	''
Patricia Margaret Corbitt, 26C Hilly Street, Mortlake, NSW	116.00	''	28/04/00
Mr Richard Corboy, "Richard Corboy S/Fund A/c", C/- 5 Henry Street, Highett	100.00	''	27/10/00
Mr Edwin Michael Corboy, 80 Keightley Road, Shenton Park, WA	320.00	''	''
Cord Investments Pty Limited, 19 Arnold St, Killara, NSW	200.00	''	''
Trudy Cordell-Mcdougall, 65 Coppin Street, East Malvern	100.00	''	''
Corela Pty Ltd, Po Box 5133, West Chatswood, NSW	120.00	''	''
Jacqueline Anne Cormack, 3/2 Billyard Avenue, Elizabeth Bay, NSW	100.00	''	''
Marina G. Cornell, PO Box 267, Doveton	262.00	''	''
Corporate Painting Maintenance Pty Ltd, PO Box 218, Corinda, Qld	169.60	''	28/04/00
Corporate Painting Maintenance Pty Ltd, PO Box 218, Corinda, Qld	212.00	''	27/10/00
Paul Alexander Corrick, 20 Preston Ave, Brighton, SA	240.00	''	''
Mr David Corrick, 53 New South Head Rd, Vaucluse, NSW	120.70	''	28/04/00
Rocco Corsaro & Silvana Corsaro, 110 Queen Street, Berry, NSW	120.70	''	''
Edward Leslie Bernard Corser & Barbara Merrilyn Corser, "ELB BM Corser Super A/c", 12 Jack Place, Kuraby, Qld	900.00	''	27/10/00
Giles Peter Cortis, 12 Carslaw Street, Chifley, ACT	150.00	''	''
Gos Cory, PO Box 245, Goulburn, NSW	230.00	''	''
Elizabeth A. Cosgriff, 03 Clunes Place, Epping	151.00	''	28/04/00
Elizabeth A. Cosgriff, 03 Clunes Place, Epping	250.00	''	27/10/00
Est Mary Josephine Cossins, C/- Boulton Julian Squire, 6th Floor, 60 York Street, Sydney, NSW	225.60	''	28/04/00
Santo Costanzo & Ninette Costanzo, 2 Silvana Court, Doncaster East	200.00	''	''
Mr Joseph Costanzo, "Costanzo Family Super A/c", 2A Yamma Street, Sefton, NSW	150.00	''	27/10/00
Joseph Costanzo, 31 Wakeford Road, Strathfield, NSW	102.40	''	28/04/00
Joseph Costanzo, 31 Wakeford Road, Strathfield, NSW	128.00	''	27/10/00
Est Henry Lancelot Costello, 40 Minimbah Road, Northbridge, NSW	120.70	''	28/04/00
Est Henry Lancelot Costello, 40 Minimbah Road, Northbridge, NSW	200.00	''	27/10/00
Padraic Liam Costigan, 15/27 Dickens Street, Elwood	150.00	''	''
Tim Costigan, Clyde Park Old Highw, Glenrowan	120.00	''	''
Adam Grant Cogle, PO Box 328, The Junction, NSW	132.85	''	28/04/00
Adam Grant Cogle, PO Box 328, The Junction, NSW	220.00	''	27/10/00
Patricia Mary Coulter, 9 Greyleaves Ave, Burradoo, NSW	100.00	''	''
County Pty Ltd, PO Box 1567, Adelaide, SA	284.95	''	28/04/00
County Pty Ltd, PO Box 1567, Adelaide, SA	472.00	''	27/10/00
Douglas Charles Courtney, 18 Smallburn Ave, Newborough	100.00	''	''
Brian Anthony Coutts & Anne Elizabeth Coutts, 962 High Street, Reservoir	200.00	''	''
Coverfate Pty Ltd, 126A Lawrence Street, Harbord, NSW	109.00	''	''

Mr Gordon James Cowe & Mrs Marie Alison Cowe, 12922 Lake Center Run, Houston Texas 77041 USA	107.16	”	28/04/00
Mr Gordon James Cowe & Mrs Marie Alison Cowe, 12922 Lake Center Run, Houston Texas 77041 USA	145.00	”	27/10/00
Mrs Siobhan Mary Cowell, 10/114 Bonney Avenue, Clayfield, Qld	100.00	”	”
Jennifer Cowell, 126 River Avenue, Chatswood, NSW	176.00	”	28/04/00
Alistair Stewart Cowie, 7 Bilkurra Avenue, Bilgola, NSW	100.00	”	27/10/00
Donald W. Cox & Joan E. Cox, “Calivil Mgmt Svcs S/F A/c”, PO Box 180, Essendon	144.95	”	28/04/00
Donald W. Cox & Joan E. Cox, “Calivil Mgmt Svcs S/F A/c”, PO Box 180, Essendon	240.00	”	27/10/00
Joan Elizabeth Cox, PO Box 180, Essendon	100.00	”	”
Donald William Cox, PO Box 180, Essendon	100.00	”	”
Andrew Cox, PO Box 2527, North Parramatta, NSW	100.00	”	”
Donald Cox & Joan Cox, “Calivil Mgt Serv S Fund A/c”, PO Box 180, Essendon	144.95	”	28/04/00
Donald Cox & Joan Cox, “Calivil Mgt Serv S Fund A/c”, PO Box 180, Essendon,	240.00	”	27/10/00
Joan Cox, 5 Riverview Road, Essendon	100.00	”	”
Don Cox, 5 Riverview Road, Essendon	100.00	”	”
Rosemary Cox, 141 Railway Avenue, Laverton	250.00	”	”
Mr Donald Cox, PO Box 180, Essendon	100.00	”	”
Stuart Anthony Cox & Anne-Marie Cox, 2/60 Drummond Street, Chadstone	200.00	”	”
Richard Norman Cox, PO Box 1054, Griffith, NSW	160.00	”	28/04/00
Cox Property Limited, 75 Rose Street, Essendon	140.00	”	27/10/00
Max Coxhead, C/- Capital Creation, 321 Glenhuntly Road, Elsternwick	100.00	”	”
Mr Bruce Edward Coyle, C/-Ernst & Young, 321 Kent Street, Sydney, NSW	350.00	”	”
Patrick David Coyne, 45 Brownhill St, Mundingburra, Qld	150.00	”	”
Brendan Vincent Coyne, 45 Brownhill Street, Mundingburra, Qld	120.00	”	”
Mr Trevor John Crabtree & Mrs Kylie Janine Crabtree, 14 Ellt Crescent, Noble Park	110.00	”	”
Mr Kylie Janine Crabtree, 14 Ellt Crescent, Noble Park	100.00	”	”
Andrew John Craig, 13 Toolaby Avenue, Beaumont, SA	100.00	”	”
Ms Fiona Elspeth Craig, 45/1 Hughes Avenue, Main Beach, Qld	100.00	”	”
Lisa Nicole Crane, 104 Jerrang Street, Indooroopilly, Qld	120.00	”	28/04/00
Ronald Thomas Crane, 22/187 Mckean Street, North Fitzroy	177.70	”	27/10/00
Mr Anthony Phillip Cranston, 22 James Street, Pakenham	120.70	”	28/04/00
Mr Cyril Francis Crasto, Unit 1, 15 Nelson Street, Chatswood, NSW	100.00	”	27/10/00
Brett Glendinning Crawford, 31 Dixon St, Wulkuraka, Qld	138.90	”	28/04/00
Brett Glendinning Crawford, 31 Dixon St, Wulkuraka, Qld	230.00	”	27/10/00
Christopher G Crawford, 25 Pinehill Drive, Frankston	112.00	”	28/04/00
Mr Leslie Owen Crawford, 42 Attewell Street, Nundah, Qld	100.00	”	27/10/00
Miles Andrew Crawley & Helen Mary Crawley, “Crawley Super Fund A/c”, 11 Westbury St, Hackney, SA	140.00	”	”
Createl Enterprises Pty Ltd, PO Box 466, Moonee Ponds	150.00	”	”
David Creed, 13 Delmont Court, Cranbourne	108.60	”	28/04/00

Robert Creek, PO Box 42301, Casuarina, NT	100.00	''	27/10/00
Torry James Creglin, 4/64 Collingwood Street, Paddington, Qld	160.00	''	''
Crellin Nominees Pty Ltd, "Crellin Super Fund A/c", 31 Bannick Court, Anning Vale, WA	208.00	''	28/04/00
Mavis Eileen Cretier, PO Box 1242, Toowong, Qld	112.00	''	''
Mavis Eileen Cretier, PO Box 1242, Toowong, Qld	140.00	''	27/10/00
Bruno Crisafi & Teresa Crisafi, 79 Regent Street, East Preston	100.00	''	''
Victor Robert Critoph, 72/47 Neridah St, Chatswood, NSW	200.00	''	''
Sue Elaine Croall, 7 Methuen Road, Mosman, NSW	192.00	''	28/04/00
Sue Elaine Croall, 7 Methuen Road, Mosman, NSW	240.00	''	27/10/00
Crocpot Pty Ltd, Harts Parade, East Hawthorn	100.00	''	''
Annabel Rosalind Cropper, 29 Cascade Street, Paddington, NSW	560.00	''	''
Ms Annabel Rosalind Cropper, 29 Cascade Street, Paddington, NSW	800.00	''	''
Thomas Ross Charles Cropper, Greenhills, Willow Tree, NSW	800.00	''	28/04/00
Geoffrey Francis Cross & Janet Clare Savage, 6 Parsons Street, Fannie Bay, NT	100.00	''	27/10/00
Est John Kenneth Cross, C/- Herbert Smith & W. B. Phillips, 'Beanbah', Level 3, 235 Macquarie St, Sydney, NSW	500.00	''	''
Deborah Jane Cross, 8 Yacca Street, Whyalla Stuart, SA	112.00	''	28/04/00
Cheryl Anne Cross & Colin James Cross, 39 McFarlane Street, South Grafton, NSW	128.00	''	27/10/00
Colin John Crow, "Saubee Super Fund A/c", 21 Shonagh Court, Birkdale, Qld	100.00	''	''
Mrs Leisa Crowe, 5 Richmond Court, Castle Hill, NSW	124.00	''	''
John Adrian Crowley, 12 Trinity Place, Robina, Qld	120.70	''	28/04/00
Reita May Cruickshank, 356 Abernethy Road, Cloverdale, WA	100.00	''	27/10/00
Mrs Renae Patricia Cruickshank, 150 Brookdale Street, Floreat, WA	100.00	''	''
Roslyn June Cruse, 131 Trafalgar Street, Stanmore, NSW	120.70	''	28/04/00
Roslyn June Cruse, 131 Trafalgar Street, Stanmore, NSW	200.00	''	27/10/00
Mr John Csaki, 90 Baracchi Crescent, Giralang, ACT	137.60	''	28/04/00
CSC Superannuation Fund, Unit 2/25 Research Road, Pooraka, SA	152.80	''	''
Mr Jason Adam Cseszko, 41 Missouri Avenue, Wagga Wagga, NSW	180.00	''	27/10/00
Robert Cucinotta & Jane Elizabeth Cucinotta, 56 Madeline Street, Preston	200.00	''	''
Cuckfield Pty Ltd, Suite 25, Kobold House, 17 Prowse Street, West Perth, WA	528.00	''	28/04/00
Ned Culic & Karen Culic, 17 Grafton Street, Elsternwick	100.00	''	27/10/00
Judith Cullen, 15 Denny Road, Picnic Point, NSW	100.00	''	''
David John Cullip, 11 Hillview Street, Dromana	120.00	''	''
Gerald Cummings & Anna Cummings, 11B Regal Avenue, Kings Langley, NSW	100.00	''	''
Mrs Jacqueline Mary Cummins, 1942 Chambers Flat Road, Munruben, Qld	160.00	''	28/04/00

Mrs Jacqueline Mary Cummins, 1942 Chambers Flat Road, Munruben, Qld	200.00	''	27/10/00
Keith Cummins, RSD 186, Cohuna	100.00	''	''
Elizabeth Cummins, RSD 186, Cohuna	100.00	''	''
Mr Terry Leslie Cummins, "The Cummins Family S/F A/c", Unit 3, 4 Skyline Place, Frenchs Forest, NSW	120.00	''	''
Elizabeth Alecia Cumper, 2/14 Strickland Street, South Perth, WA	100.00	''	''
Mr Sean Michael Cunial, 4/48 Ben Boyd Road, Neutral Bay, NSW	160.00	''	''
Alexander Gerald Cunningham, 219 Stanley Rd, Carina, Qld	120.00	''	28/04/00
Karen Cunningham-Dunlop, 22 Hazelwood Loop, Carine, WA	175.25	''	28/04/00
Karen Cunningham-Dunlop, 22 Hazelwood Loop, Carine, WA	290.00	''	27/10/00
Karen Cunningham-Dunlop, "Kimberley Cunningham-Dunlop A/c", 22 Hazelwood Loop, Carine, WA	140.00	''	''
Mr Paul Anthony Curnow, 10 Bignold Avenue, Bendigo	132.50	''	''
Michael John Curran, 1 Kirk Court, Samford, Qld	100.00	''	''
James Donald Curtis, 4 Mengler Ave, Claremont, WA	160.00	''	28/04/00
Ms Sally Anne Curtis, 14 McTaggart Crescent, Kambah, ACT	100.00	''	27/10/00
Curtis Tebbutt Super Pty Ltd, 15 Browns Road, Montrose	100.00	''	''
Curtis Tebbutt Super Pty Ltd, 15 Browns Road, Montrose	100.00	''	''
Trent James Cusack, 100 Ward Street, Indooroopilly, Qld	100.00	''	''
Ms Claudia Cuschieri, 79 Wood Street, Manly, NSW	100.00	''	''
Ms Sarah Cutter-Russell, PO Box 130, Thornleigh, NSW	120.70	''	28/04/00
Ms Sarah Cutter-Russell, PO Box 130, Thornleigh, NSW	200.00	''	27/10/00
Peter Cutting, PO Box 5118, Middle Park	100.00	''	''
Cyrulla's Instruments Pty Limited, 11/4 Garling Road, Kings Park, NSW	230.00	''	''
Andrew Czechowicz, PO Box 153, Glenside, SA	100.00	''	''
Barbara Czerwinski, 29 Hazel Street, Pendle Hil, NSW	132.60	''	''
D. & D. Machinery Pty Ltd, Box 1014, Griffith, NSW	240.00	''	28/04/00
D. & D. Machinery Pty Ltd, Box 1014, Griffith, NSW	300.00	''	27/10/00
D. & J. Cole Pty Ltd, ATF "Burdeki N. Park Super Fund A/c", 94 George Street, Singleton, NSW	108.00	''	''
D. E. & B. L. Nominees Pty Ltd, "Super Fund A/c", 76 Toolamba Road, Mooroopna	100.00	''	''
Mr Bruno D'Annolfo, 2 Aitken Drive, Winthrop, WA	100.00	''	''
Walter D'Onofrio & Marie Rostek, 401 Napier Street, Fitzroy	100.00	''	''
Daphne Lucille D'Souza, 10A Yanagin Place, West Pennant Hills, NSW	160.00	''	28/04/00
Daphne Lucille D'Souza, 10A Yanagin Place, West Pennant Hills, NSW	200.00	''	27/10/00
Mr Clarence D'Souza, "D'Souza S/F A/c", 10A Yanagin Place, West Pennant Hills, NSW	150.40	''	28/04/00
Mr Clarence D'Souza, "D'Souza S/F A/c", 10A Yanagin Place, West Pennant Hills, NSW	188.00	''	27/10/00
Mr Wayne Oliver John Dade, 5 Pearce Street, Hove, SA	104.00	''	''
Ms Anne Clarissa Dade, 5 Pearce Street, Hove, SA	104.00	''	''
Mr Wayne Oliver John Dade & Mrs Anne Clarrisa Dade, "A. & L. Dade Family Trust A/c", 5 Pearce St, Hove, SA	104.00	''	''
Mrs Evonne Marion Daff, 1 Edith Street, Darlington, WA	160.00	''	28/04/00

Stuart Daffy, 9 William Place, North Rocks, NSW	150.00	''	27/10/00
Chandra Dahia, PO Box 239, Box Hill	100.00	''	''
Karishma Dahia, PO Box 239, Box Hill	100.00	''	''
Vanita Dahia, PO Box 239, Box Hill	100.00	''	''
Dahia Pty Ltd, PO Box 239, Box Hill	100.00	''	''
James Dale, 1/91 Hastings Street, Scarborough, WA	124.60	''	''
Diane Janet Dale, 41 Mill Street, Koroit	110.00	''	''
Dalenet Pty Ltd, "Integral Resources S/F A/c", 7 Kamira Road, Lilli Pilli, NSW	200.00	''	''
Roderick Graham Dagleish & Helen Renae Dever, 79 Dolphin Crescent, Whale Beach, NSW	100.00	''	''
Mr Joseph John Dall, PO Box 845, Nedlands, WA	100.00	''	''
Sarah Dallen, 23 Brierley Street, Mosman, NSW	240.00	''	''
Ian Dallen, 23 Brierley Street, Mosman, NSW	240.00	''	''
Mr Frank Dalmati & Mrs Nadia Dalmati, "Super Fund Account", 7 Saltbush Place, Bossley Park, NSW	200.00	''	''
Dalsio Pty Ltd, "Dalsio Pty Ltd S/Fund A/c", 10 Bishopgate Street, Wickham, NSW	120.00	''	''
Mr James Edward Dalton, 11/2 Pearson St, Balmain, NSW	229.30	''	28/04/00
Mr James Edward Dalton, 11/2 Pearson St, Balmain, NSW	380.00	''	27/10/00
Ms Anna Catherine Dalton, C/- 14 Trevor Road, Newport Beach, NSW	229.30	''	28/04/00
Ms Anna Catherine Dalton, C/- 14 Trevor Road, Newport Beach, NSW	380.00	''	27/10/00
Bradley James Dalton & Alison Mary Dalton, "Dalton Super Fund A/c", 158 Stawell Street, Burnley	160.00	''	28/04/00
Bradley James Dalton & Alison Mary Dalton, "Dalton Super Fund A/c", 158 Stawell Street, Burnley	200.00	''	27/10/00
Mr Brian Dalton, PO Box 60, Oatley, NSW	146.00	''	''
Paul Anthony Daly & Robyn Frances Daly, 19 Erang Avenue, Kirrawee, NSW	200.00	''	''
Timothy Daly, 39 Kethel Road, Beecroft, NSW	160.00	''	''
Rupert Daly, 10/45 Duet Drive, Mermaid Waters, Qld	126.75	''	28/04/00
Rupert Daly, 10/45 Duet Drive, Mermaid Waters, Qld	210.00	''	27/10/00
John Dam, 3/84 Leylands Parade, Belmore, NSW	100.00	''	''
Frank Damiano, 40 Denison St, Villawood, NSW	260.00	''	''
Mr Gregory James Daniel, 14 Rayner Road, Whale Beach, NSW	151.00	''	28/04/00
Ms Tara Lynette Daniel, 39 Boomerang Street, Turramurra, NSW	120.70	''	''
Ms Tara Lynette Daniel, 39 Boomerang Street, Turramurra, NSW	200.00	''	27/10/00
Mr Ben Edwin Daniels, 283 Edward Street, Brunswick East	168.00	''	28/04/00
Mr Colin F Dannevig & Mrs Gloria J. Dannevig, 54 Carara Avenue, Thagoona, Qld	100.00	''	27/10/00
James Danson, 118 Castlecrag Dr, Kallaroo, WA	160.00	''	''
Dartec Industries Pty Ltd, PO Box 189, Mount Eliza	100.00	''	''
Miles Benjamin Darveniza & Margaret Patricia Darveniza, Ms 216, Henderson Drive, Innisfail, Qld	120.70	''	28/04/00
Daryn-Milea Pty Ltd, 75 Rose Street, Essendon	140.00	''	27/10/00
Dat Investments Pty Ltd, Level 18, 644 Chapel Street, South Yarra	100.00	''	''
Shachi Dave, Unit 2, 33-35 Forster St, West Ryde, NSW	100.00	''	''

Marjorie Ysobel Davey, 5 Greenwood Ave, Belmont, NSW	100.00	''	''
Peta Lee Davey, 17 Bimbil Place, Castle Hill, NSW	100.00	''	''
Linda Maria Davey, 11 Cahill Street, Aitkenvale, Qld	262.65	''	28/04/00
Lancelot Howard Davids, 89 Australia St, Bass Hill, NSW	140.00	''	27/10/00
Paul Davids, 172/71 Victoria Street, Potts Point, NSW	250.00	''	''
Jennifer Helen Davidson, Memagong, Young, NSW	212.00	''	28/04/00
Jennifer Helen Davidson, Memagong, Young, NSW	265.00	''	27/10/00
Mrs Leanne Sheryl Davidson & Mr Shamus Bruce Davidson, 3 Agnes Street, Shorncliffe, Qld	150.00	''	''
Davidson Music Pty Ltd, "Davidson Super Fund A/c", 5 Sandy Bay Road, Clontarf, NSW	160.00	''	''
Kenneth Lindsay Davies & Bernadette Gillian Ganley, 38 Giles Street, Alice Springs, NT	100.00	''	''
John Lloyd Davies, PO Box 242, Gordon, NSW	100.00	''	''
Dorothy Annie Davies, 2 McKenna Court, Retreat Road, Bendigo	100.00	''	''
Glyn Davies, 652 Canning Street, Carlton North	160.00	''	28/04/00
Mr Eiddon Luther Davies, Jl Pendidikan No 64, Mataram, Lombok NTB, Indonesia	100.00	''	27/10/00
Joan Frances Marion Davies, 616 Main Road, Eltham	100.00	''	''
Mr Jonathan Robert Davies, 8 Ionic Place, Shelley, WA	212.80	''	28/04/00
Rachel Alexandra Davis, 75 Coolawin Road, Northbridge, NSW	256.00	''	''
Rachel Alexandra Davis, 75 Coolawin Road, Northbridge, NSW	320.00	''	27/10/00
Fredrick Howard Davis, 22 Clovelly Rd, Randwick, NSW	120.00	''	''
Judith Davis, 53 Beaumont Street, Rose Bay, NSW	112.00	''	28/04/00
Mr James Patrick Davis, Unit 29, 1-5 Russell Street, Wollstonecraft, NSW	1,280.00	''	''
Dyrelle Davis, 19 Pryor Place, Emerald, Qld	100.00	''	27/10/00
Ms Terese Davis, 12/27 Heaslip Street, Coniston, NSW	110.00	''	''
Hugh Charles Davison, PO BOX 302, Walkerville, SA	360.00	''	28/04/00
Hugh Charles Davison, PO Box 302, Walkerville, SA	450.00	''	27/10/00
Estate William Dawbin, 3/6 Ray St, Turrumurra, NSW	170.30	''	28/04/00
Mr Amit Navnit Dawda, PO Box 4552, Ringwood	100.00	''	27/10/00
Janet A Dawes, 3/13 Brougham Street, Box Hill	224.00	''	28/04/00
Janet A Dawes, 3/13 Brougham Street, Box Hill	280.00	''	27/10/00
Mrs Diane Dawkins, PO Box 969, Mandurah, WA	1,191.00	''	''
Mr Anthony Dawkins, PO Box 969, Mandurah, WA	1,212.00	''	''
Mrs Diane Dawkins & Mr Anthony Dawkins, PO Box 969, Mandurah, WA	408.00	''	''
Stephen James Dawson, 14 Godwin Street, Cranbourne	168.00	''	28/04/00
Mr Alexander Tamerlane Dawson, 64 Ruthven Street, Bondi Junction, NSW	100.00	''	27/10/00
Peter Louis Day, 49 Barnes Road, Llandilo, NSW	150.00	''	''
Ms Rebecca Louise Day, 1 King Street, Mile End, SA	170.00	''	''
Ms Rebecca Louise Day, 8 Kalmia Avenue, Crafers, SA	136.00	''	28/04/00
Maria Donzilia Marques De & Sousa Ferraz, 15 Barton Street, Mount Isa, Qld	120.00	''	27/10/00
Maria Op De Beeck, "Sarah M Samarghandi A/c", 12 Adare Place, Killarney Heights, NSW	112.00	''	28/04/00
Mr Frank De Bloois & Mrs Alice Debloois, 20779 Wellhouse Court, Ashburn, Virginia 20417 USA	100.00	''	27/10/00

John Ribot De Bresac, Po Box 751f, Melbourne	160.00	''	28/04/00
John Ribot De Bresac, Po Box 751f, Melbourne	140.00	''	27/10/00
Mr Pierre De Dassel, Top Flat, 910 Military Road, Mosman, NSW	160.00	''	28/04/00
Mr Pierre De Dassel, 910 Military Road, Mosman, NSW	120.70	''	''
Anthony De Fazio, Development - Voice Products, Locked Bag 2030, Box Hill	151.00	''	''
Anthony De Fazio, Development - Voice Products, Locked Bag 2030, Box Hill	250.00	''	27/10/00
Raoul Zani De Ferranti & Margot Ziani Simington, C/- 34 Bremer Street, Griffith, ACT	110.00	''	''
Mr Angelo Antonio De Grazia & Mrs Charlotte Ella De Grazia, "De Grazia Super Fund A/c", Great Alpine Rd, Myrtleford	104.00	''	28/04/00
Sophie Louise De Jersey, 8 Rigg Place, Mcdowall, Qld	100.00	''	27/10/00
Humbert De Lambilly, PO Box 679, Hawthorn	160.00	''	28/04/00
Lyndall De Marco & Louise De Marco & Alison De Marco, 25 Timbarra Crescent, Jindalee, Qld	120.00	''	27/10/00
Sonia De Melis, 15 St David Street, Northcote	130.00	''	''
Mr Dominic De Minaur, 2-23 Court Rd, Double Bay, NSW	120.00	''	''
Luigi De Paolis, 183 Amelia Street, Balcatta, WA	100.00	''	''
Sam De Petro, PO Box 31, Avondale Heights	120.00	''	28/04/00
Grace De Petro, PO Box 31, Avondale Heights	120.00	''	''
Andrew Jamie De Rooy, 19 Molonglo Road, Seven Hills, NSW	208.00	''	''
Andrew Jamie De Rooy, 19 Molonglo Road, Seven Hills, NSW	260.00	''	27/10/00
Mr Don Simon Patabandi Bandu De Silva, 16 Wijesekara Mawatha, Mirihana, Nugegoda, Sri Lanka	120.70	''	28/04/00
Don Patabandi Uresh De Silva, 16 Wijesekara Mawatha, Mirihana, Nugegoda, Sri Lanka	120.70	''	''
Sultana De Souza & Riyaz De Souza, C/- Tower Trust Limited, PO Box Z5484, Perth, WA	100.00	''	27/10/00
Philip Howard Deall & Janet Anne Deall, PO Box 126, Urana, NSW	140.00	''	''
Barry Dean, 3 Coral Road, Cronulla, NSW	100.00	''	''
Mrs Catherine Jane Deane, Merrill Lynch, Ropemaker Place 25 Ropemaker Street, London EC 2Y9IY, United Kingdom	100.00	''	''
Trevor Deb, 11/196 Forbes Street, Darlinghurst, NSW	204.00	''	''
Corinne Decastro-Basto, 107 Kirribilli Ave, Kirribilli, NSW	120.70	''	28/04/00
Deepwoods Investments Pty Ltd, 16 Ainslie Road, North Fremantle, WA	500.00	''	27/10/00
Bonefacia Catharina Degraaf, 11 Bareena Court, Palmwoods, Qld	120.00	''	''
Bonefacia Catharina Degraaf, 6 Bareena Court, Palmwoods, Qld	120.00	''	''
Mr John Dehne & Ms Diann Green, 64 Lipton Drive, Thomastown	100.00	''	''
Mr Chris John Delahunty, 39 George Street, Ballarat	120.70	''	28/04/00
Leon Delcampo & Rosemary Ann Delcampo, 3 Lockwood Crescent, Whyalla Jenkins, SA	160.00	''	''
Leon Delcampo & Rosemary Ann Delcampo, 3 Lockwood Crescent, Whyalla Jenkins, SA	200.00	''	27/10/00

Ms Kylee Maree Delios, 32 Porter Road, Balwyn	200.00	''	''
Claude Dellabona, 20 Farrington Road, Leeming, WA	100.00	''	''
Angelo Deluca & Emilia Deluca, 130 Cumberland Rd, Pascoe Vale	120.00	''	''
Brenton M. Delurant, 45 Bristol Terrace, Hillcrest, SA	151.00	''	28/04/00
Brenton M. Delurant, 45 Bristol Terrace, Hillcrest, SA	250.00	''	27/10/00
Marija Demic, 144 Foveaux Street, Surry Hills, NSW	100.00	''	''
Denban Pty Ltd, "The Bourke Family A/c", 133 Zigenfusz Road, Thornlands, Qld	542.95	''	28/04/00
Hui Yi Deng, PO Box K28, Haymarket, NSW	100.00	''	27/10/00
Mr Richard Denness Jnr, 405 Majestic Cove, Alpharetta, Georgia 30004 USA	160.00	''	''
Zofia Depczynski, 176 Franklin Street, Matravill, NSW	415.00	''	''
Derby Falls Pty Ltd, "The Pikora Super Fund A/c", PO Box 128, Subiaco, WA	117.20	''	28/04/00
Derby Falls Pty Ltd, "The Pikora Super Fund A/c", PO Box 128, Subiaco, WA	146.50	''	27/10/00
Mr Christian Paul Derrick, 48/41 Rocklands Road, Crows Nest, NSW	207.50	''	''
Ben Mark Derwent, Level 67, MLC Centre, Martin Place, Sydney, NSW	133.00	''	''
Design Cad Super Fund, 2 Neptune Crescent, West Beach, SA	127.90	''	28/04/00
Design Plan Pty Ltd, "Super Fund A/c", C/- Fenwick Ennis Rie, C/n Old & New Street, North Adelaide, SA	1,000.00	''	27/10/00
Ms Mary-Lou Desmond, 4/59 Budley Street, Coogee, NSW	100.00	''	''
Shaheen Desouza, C/- Tower Trust Limited, PO Box Z5484, Perth, WA	160.00	''	''
Clinton Desouza & Riyaz Deouza, C/- Tower Trust Limited, PO Box Z5484, Perth, WA	160.00	''	''
George Despinoudis, 10 Glenunga Ave, Glenunga, SA	120.70	''	28/04/00
George Despinoudis, 10 Glenunga Ave, Glenunga, SA	200.00	''	27/10/00
Anita Deutsch, 34/108 Greville Street, Prahran	296.00	''	28/04/00
George Durairaj Deva & Esther Maud Nesamalar Deva, "George & Nesa Deva A/c", 11 Garonne St, Kearns, NSW	100.00	''	27/10/00
Devami Pty Ltd, 2/174 Phillip Street, Sydney, NSW	100.00	''	''
Ms Deborah Maree Devattimo, 12 Lawley Road, Lesmurdie, WA	100.00	''	''
Barry Michael Devine & Vicki Leanne Devine, 26 Rocca Street, Denistone East, NSW	120.70	''	28/04/00
Vicki Leanne Devine & Barry Michael Devine, 26 Rocca Street, Denistone East, NSW	101.40	''	''
Alice Devine, PO Box H239, Australia Square, Sydney, NSW	100.00	''	27/10/00
Steven Peter Devine, 20 Fulford Street, Scarborough, WA	161.60	''	28/04/00
Michael William Devlin, 92 Mt Pleasant Road, Belmont	112.00	''	''
Ms Annemarie Devlin, RMB 1160, Glenrowan	100.00	''	27/10/00
Mr Ali Dhorajiwala, PO Box 4647, North Rocks, NSW	580.00	''	''
Mr Ian Hugh Alexander Dhu & Mrs Norma Dhu, PO Box 325, Burleigh Town, West Burleigh, Qld	100.00	''	''
Francis Dhuray, 24 Launceston Avenue, Banksia Park, SA	187.00	''	''
Mr Lou Di Lazzaro & Mrs Denise Di Lazzaro, 21 Winchcombe Place, Castle Hill, NSW	349.00	''	''
Maria G. Di Losa, 15 Alexander Street, Concord, NSW	120.00	''	''

Christopher Di Losa, 15 Alexandria St, Concord, NSW	120.00	''	''
Christopher Di Losa & Maria Di Losa, 15 Alexandera Street, Concord, NSW	120.00	''	''
Luana Michelle Di-Domenico, Unit 2, 152 Smith Street, Larrakeyah, NT	100.00	''	''
Antonio Di-Mase, 474 Canning St, North Carlton	100.00	''	''
Mr George Diamataris, 9 Richard Road, Oyster Bay, NSW	150.00	''	''
Elizabeth Jean Diamond, Unit 3, 16 Rutherford Street, Yorkey's Knob, Qld	100.00	''	''
Diamond Rock Pty Ltd, 35 Emma Street, Collingwood	288.00	''	28/04/00
Diamond Rock Pty Ltd, 35 Emma Street, Collingwood	360.00	''	27/10/00
Dianne Yee, 7 Yarrabin Crescent, Berowra, NSW	100.00	''	''
Mr Russell Wilfred Dibble, 307 Glenmore Road, Paddington, NSW	100.00	''	''
Mrs Gillian Denise Dibble, 307 Glenmore Road, Paddington, NSW	100.00	''	''
Mr Russell Wilfred Dibble, "Jackson Alexander Dibble A/c", 307 Glenmore Road, Paddington, NSW	100.00	''	''
Mrs Gillian Denise Dibble, 103 Moncur Street, Woollahra, NSW	120.70	''	28/04/00
Mrs Gillian Denise Dibble, 103 Moncur Street, Woollahra, NSW	200.00	''	27/10/00
Kathleen Teresa Dibbs, PO Box 431, Morningside, Qld	200.00	''	''
Ms Sylvia May Dickerson, 19/57 Cobar Street, Dulwich Hill, NSW	160.00	''	28/04/00
Barry Francis Dickson, 129 St Georges Road, Northcote	100.00	''	27/10/00
Dickson Secretarial Services Ltd, 8 Huntingfield Street, Doncaster East	100.00	''	''
Mr Tole Digalovski & Mrs Gorica Digalovski, Level 2, 263 George St, Sydney, NSW	362.15	''	28/04/00
Mr Tole Digalovski & Mrs Gorica Digalovski, Level 2, 263 George Street, Sydney, NSW	600.00	''	27/10/00
Mr Courtney Diggins, 21 Liquidamber Hts, Mirrabooka, WA	160.00	''	''
Digital One Pty Ltd, "Digital One Pty Ltd A/c", Level 7, 186 Blues Point Road, North Sydney, NSW	100.00	''	''
Rebecca Dilosa, 15 Alexandra Street, Concord, NSW	120.00	''	''
Est Geoffrey John Dineen, C/- Zeeman Kable & Page, PO Box 300, Launceston, Tas.	100.00	''	''
Jiewen Ding, PO Box 136, Crows Nest, NSW	328.00	''	''
Jie Wen Ding, PO Box 136, Crows Nest, NSW	108.00	''	''
Mr Carlos Dinis & Mrs Cheryl Dinis, 16 Burns Circuit, McKellar, ACT	150.00	''	''
Mr Michael Samuel Diss, 10/14A Acland Street, St Kilda	100.00	''	''
Kaylene Diston, "Brett Diston A/c", 4 Wattle Valley Road, Mount Evelyn	100.00	''	''
Leslie James Dix, 23 Ultimo Street, Mansfield	100.00	''	''
Dorothy Elisabeth Dix, 23 Ultimo Street, Mansfield	100.00	''	''
Megan Louise Dixon, 3670 South Gippsland Highway, Koo Wee Rup	120.00	''	''
Elliot James Dixon, 3670 South Gippsland Hwy, Koo Wee Rup	120.00	''	''
Norman L. Dixon, Locked Bag 7011, Parramatta, NSW	160.00	''	28/04/00
Norman L. Dixon, Locked Bag 7011, Parramatta, NSW	200.00	''	27/10/00

D.J. Lunnay Pty Limited, "Superannuation Fund A/c", PO Box 685, Kempsey, NSW	212.00	"	"
D.J. Mullan & Associates Pty Ltd, "Shamrock Super Fund A/c", 317 High Street, Melton	603.10	"	28/04/00
D. J. Mullan & Associates Pty Ltd, "Shamrock Super Fund A/c", 317 High Street, Melton	1,000.00	"	27/10/00
Emily Stephana Djauhari, 3 Page Street, Attadale, WA	100.00	"	"
D.N. Pearce Plant Maintenance Superannuation Fund, 1468 Old Cleveland Road, Belmont, Qld	119.00	"	"
Ms Megan Doak, 158 Barcom Avenue, Darlinghurst, NSW	100.00	"	"
Meagan Doak, 158 Barcom Avenue, Darlinghurst, NSW	100.00	"	"
Giao Doan, 8 Burlison Street, Warwick Farm, NSW	130.00	"	"
Damian Dobbin, 330 Alma Road, Caulfield Nth	126.75	"	28/04/00
Damian Dobbin, 330 Alma Road, Caulfield Nth	210.00	"	27/10/00
Mark Norman Doberer, PO Box 298, Prahran Melbourne	100.00	"	"
Nicky M. Dobos, 56 Cole Street, Brighton	128.00	"	28/04/00
Robert James Dodd, 57b Coogee Road, Ardross, WA	100.00	"	27/10/00
Helen Margaret Doddridge, Warrawee, Kiewa Valley Highway, Kerguryah	217.20	"	28/04/00
Musa Dogan, 16/157 Crown Street, Wollongong, NSW	419.25	"	"
Mary Delma Doherty, 15 Aldridge St, Auchenflower, Qld	100.00	"	27/10/00
Paul Doherty, 39 Sanoni Avenue, Dolls Point, NSW	100.00	"	"
William Glenn Doig, 312 Playfair Place, Emu Ridge, ACT	270.00	"	"
Peter Michael Dole & Wendy Rexine Dole, 33 Cheryl Crescent, Ferntree Gully	150.00	"	"
Domenic Carbone Pty Ltd, "Super Fund A/c", 24 Lancelot Avenue, Hazelwood Park, SA	112.00	"	28/04/00
Domestic Security Pty Ltd, "Domestic Security Super A/c", Unit 10, 5 Hoddle Street, Abbotsford	120.70	"	"
Margaret Donald, 66 Henry Street, Kalinga, Qld	200.00	"	27/10/00
Peter Donaldson, 147 Woongarra Street, Bundaberg, Qld	100.00	"	"
Dondakin Investments, PO Box 28 Corrigin, Corrigin, WA	120.70	"	28/04/00
Dondakin Investments, PO Box 28 Corrigin, Corrigin, WA	200.00	"	27/10/00
Edward Hadley Donkin, 119 Maitland Rd, Sandgate, NSW	100.00	"	"
Patrick Donnan, 19 Thompson Street, Tamarama, NSW	100.00	"	"
Michael Donnan, 19 Thompson Street, Waverley, NSW	100.00	"	"
Adam Donnelley, 42a Pentecost Avenue, St Ives, NSW	120.00	"	"
Dianne Lee Donnelly, 2 Jindee Street, Bunbury, WA	100.00	"	"
Elizabeth Donnelly, "Eugene Lynch Account", 39 Eric Avenue, Lower Templestowe	100.00	"	27/10/00
Mr Robert John Donovan, 18 Vale Street, Wilston, Qld	240.00	"	28/04/00
Mr Mark Jonathan Dooley, 37 Hopetoun Street, Paddington, NSW	250.00	"	27/10/00
Philip Alexander Dorrian, 68 Landra Avenue, Mount Colah, NSW	120.00	"	"
Dotie Pty Ltd, "Super Fund A/c", 69 Tamarind Drive, Unanderra, NSW	300.00	"	"
Dotie Pty Ltd, 69 Tamarind Drive, Unanderra, NSW	280.00	"	"
Doublet Pty Ltd, "Super Fund A/c", 65 Coppards Road, Newcomb	240.00	"	28/04/00
John William Doughty & Margaret Ann Doughty, PO Box 1208, Cooma, NSW	100.00	"	27/10/00

James Campbell Douglas, 15 Dean Street, Kew	640.00	''	28/04/00
Kristy Douglas, 15/108 Mary Street, Richmond	100.00	''	27/10/00
Douglas West Investments Pty Ltd, PO Box 185, West Perth, WA	120.70	''	28/04/00
Douglas West Investments Pty Ltd, PO Box 185, West Perth, WA	200.00	''	27/10/00
Miss Mary Margaret R. Doumany, PO Box 25, Nerang, Qld	113.55	''	28/04/00
Vicki Dourios, 18 Plunkett St, West Heidelberg	192.00	''	''
Jim Doust, 35 Hyland Terrace, Rosslyn Park, SA	100.00	''	27/10/00
Mr Gregory Robert Doust, 162 Flood St, Leichhardt, NSW	269.80	''	28/04/00
Yvonne Emilia Dowling, 3 Shetland Drive, Wantirna	120.00	''	27/10/00
Alan Francis Dowling, 3 Shetland Drive, Wantirna	160.00	''	''
Alan Dowling, "Sarah Emilia Dowling A/c", 3 Shetland Drive, Wantirna	160.00	''	''
Alan Dowling, "Matthew John Dowling A/c", 3 Shetland Drive, Wantirna	120.00	''	''
Patrick Joseph Downey, 55 Keith Street, Moorabbin	292.00	''	''
Mr Russell David Downham, 3/2 McGrath Court, Richmond	160.00	''	28/04/00
Mr Kenneth Downie, 20 Matthew Street, Bedford Park, SA	100.00	''	27/10/00
Shri Muniwiyathi Doyle, 40 Fernhill Road, Sandringham	100.00	''	''
Adrian Doyle & Kylie-Ann Doyle, Unit 2, 46 St Thomas Street, Bronte, NSW	100.00	''	''
Coralie Kathleen Doyle, 13 Willard Close, Hillards Park Estate, Wellington Point, Qld	110.00	''	''
Dr Y. K. Ho Nominees Pty Limited, "Staff Superannuation A/c", PO Box 168, Keiraville, NSW	435.00	''	''
John Dribbin, 25 Curraweena Rd, Caulfield South, Melbourne	164.25	''	28/04/00
John Dribbin, 25 Curraweena Rd, Caulfield South, Melbourne	272.00	''	27/10/00
Driftelle Pty Ltd, 371 Clayton Road, Clayton	323.00	''	''
Mr Peter Drivas, "James Drivas A/c", 3 Carlisle Street, Ashfield, NSW	100.00	''	''
Mr Peter Drivas, "Andrew Drivas A/c", 3 Carlisle Street, Ashfield, NSW	100.00	''	''
Lara Drobis, 586 Swanston Street, Carlton	240.00	''	28/04/00
Mr Tony Drobnjak, 174 McDovall Stuart Ave, Whyalla, SA	160.00	''	''
Debbie Drobnjak, 174 McDouall Stuart Avenue, Whyalla Norrie, SA	260.00	''	''
Mr T Drobnjak, "Drobnjak Family A/c", 174 McDouall Stuart Avenue, Whyalla, SA	261.60	''	''
Ms Barbara Mary Drum, Unit 4, 202 Bowen Terrace, New Farm, Qld	135.85	''	''
Jean Drummond, 28 Wicklow Street, Ormond	250.00	''	27/10/00
Sally Drummond, 6/24 Park Street, Moonee Ponds	126.13	''	28/04/00
Sally Drummond, 6/24 Park Street, Moonee Ponds	208.60	''	27/10/00
Jean Drummond, 28 Wicklow Street, Ormond	782.00	''	''
Kevin James Jude Dsouza & Karen Joan Dsouza, 35 Blackett Drive, Castle Hill, NSW	100.00	''	''
David John Dudderidge, 81 Lindrum Crescent, Holt, ACT	100.00	''	''
Mr Ryan Dudley, "The Tazanne Investment A/c", 230 East 71st Street, Apt 6E New York NY 10021 USA	320.00	''	''
Peter Lewis Duff, 137 Kent Street, Ascotvale	100.00	''	''
Sally Jane Duff, RMB 221 Pheasants Rd, Wedderburn, NSW	140.00	''	27/10/00

Karen Elizabeth Duff, "Ked Superannuation Fund A/c", 26 Kasouka Road, Camberwell	100.00	"	"
Vivienne Louise Dugdale, 13A Ethel Street, Malvern	163.15	"	28/04/00
Vivienne Louise Dugdale, 13A Ethel Street, Malvern	270.00	"	27/10/00
C.J. Duggan, "Duggan S/F A/c", PO Box 1177, Gosford, NSW	120.00	"	"
Eric Owen Crickett Duggin, PO Box 853, Brookvale, NSW	240.00	"	"
Ronald Neil Duggin & Annette Gaye Duggin, "Duggin Super Fund A/c", 33 Lowood Rd, Mt Barker, WA	214.40	"	28/04/00
Ronald Neil Duggin & Annette Gaye Duggin, "Duggin Super Fund A/c", 33 Lowood Rd, Mt Barker, WA	108.00	"	27/10/00
Sanjey Dulloo, 3/26 Harris Street, Harris Park, NSW	160.00	"	"
Ms Kate Louise Dumas, 155 New Street, Brighton	100.00	"	"
Gawain Duncan, 6 Brooker Street, Glenunga, SA	100.00	"	"
Stanley Victor Dunham, 122 Racecourse Road, Mornington	100.00	"	"
Robert Edward Dunks, PO Box 12, Sumner Park, Qld	160.00	"	28/04/00
Robert Edward Dunks, PO Box 12, Sumner Park, Qld	200.00	"	27/10/00
John Dunlop, 16 Shiers Street, Alphington	265.60	"	28/04/00
John Dunlop, 16 Shiers Street, Alphington	332.00	"	27/10/00
Barry John Dunn & Shirley Elizabeth Dunn, 1136 Kangaroo Valley Road, Berry, NSW	120.00	"	"
Paul Stephen Dunn, 22 Connex Road, Umina, NSW	241.45	"	28/04/00
Paul Stephen Dunn, 22 Connex Road, Umina, NSW	400.00	"	27/10/00
John Hayward Dunning & Patricia Lynette Dunning, "J H Dunning Super Fund A/c", 769 Doncaster Road, Doncaster	100.78	"	28/04/00
John Hayward Dunning & Patricia Lynette Dunning, "J H Dunning Super Fund A/c", 769 Doncaster Road, Doncaster	166.60	"	27/10/00
Thi Tot Duong & Lawrence Quoc Hoa Duong, Unit 1102, 5 Albert Road, Strathfield, NSW	120.00	"	28/04/00
Nguyen H. Duong, 7 Kambara Drive, Mulgrave Durham Road Nominees Pty Ltd,	230.10	"	"
"Tyler Super Fund A/c", 313 Glenferrie Road, Malvern	240.00	"	27/10/00
Mr Kevin Alan Durston, 20 Millicent St, Greystanes, NSW	160.00	"	28/04/00
Mr Kevin Alan Durston, 20 Millicent St, Greystanes, NSW	432.50	"	27/10/00
Marie Micheline Duval, 9 Whitehaven Crescent, North Noble Park	100.00	"	"
Kieran Anthony Dwyer, Lot 11, Chellow Dene, Stanwell Park, NSW	100.00	"	"
Mr Craig Dymke, C/- Rosemount Pty Ltd, GPO Box 1428, Brisbane, Qld	100.00	"	"
Dynamedia Pty Ltd, 23 Bonney Street, Ainslie, ACT	104.00	"	"
Dynamic Customs Services Pty Ltd, "Superannuation Fund A/c", PO Box 443, Mascot Sydney, NSW	253.55	"	28/04/00
Dynamic Customs Services Pty Ltd, "Superannuation Fund A/c", PO Box 443, Mascot Sydney, NSW	420.00	"	27/10/00
Mr Andrew Leopold Dytkowski, 113 Deakin Street, Silverwater, NSW	100.00	"	"
Mr Robert Dzik, 15/1 Wellington Street, Clayfield, Qld	132.85	"	28/04/00

E. J. E. C. Nominees Pty Ltd, "Portmans Hardware A/c", 23 Balmoral Drive, Parkdale	100.00	"	27/10/00
E. T. Lawrence Pty Ltd, "Lawrence Family A/c", 10 Treffos Place, Newstead, Tas.	100.00	"	"
E-Sharevest Pty Limited, 9 Hibiscus Close, Alford's Point, NSW	100.00	"	"
Geoffrey Robert Eadie & Jacqueline Susan Eadie, 25 Hallett Road, Erindale, SA	200.00	"	"
Ms Lesley Joy Early, 131 Little Cove Road, Warrior, Alabama 35180USA	110.00	"	"
Jill M. Earnshaw, 300 Buckley Street, Essendon	168.00	"	28/04/00
Earthsciences Pty Ltd, "Super Fund Account", 3 Neville Road, Dalkeith, WA	120.70	"	"
Earthsciences Pty Ltd, "Super Fund Account", 3 Neville Road, Dalkeith, WA	200.00	"	27/10/00
Mr Stephen John East & Mrs Susan Kay East, 36 Tallong Drive, Lake Cathie, NSW	100.00	"	"
East Group Pty Ltd, 106 Caroline Chisholm Drive, Winston Hills, NSW	100.00	"	"
John Norman Easter, 58 Llewellyn Street, Oatley, NSW	160.00	"	28/04/00
Charles William Mahon Easton, 100 Alexandra St, Bardon, Qld	120.00	"	27/10/00
David Murray Eccleston, 12 Phonix Place, Illawong, NSW	140.00	"	"
Mr Nicholas Economo, 6 Minerva Way, Carine, WA	100.00	"	"
Edata Image Pty Ltd, 5/12 Stanley Street, Box Hill South	110.00	"	"
Bruce Eddings, Lizard Is Lodge, PMB 40, Cairns, Qld	100.00	"	"
James Joshua Edelman, 12 Riversea View, Mosman Park, WA	134.00	"	"
Narele Anne Edgar, 54 Fitzgerald Street, Northbridge, WA	241.45	"	28/04/00
Narele Anne Edgar, 54 Fitzgerald Street, Northbridge, WA	400.00	"	27/10/00
Carolyn Ruth Edgar, 144 Esplanade, Port Noarlunga South, SA	116.00	"	"
Dr Gamini Edireweera, PO Box 173, Taihape, New Zealand	130.00	"	"
Mr Stuart Edmond, Unit 2, 86 West Esplanade, Manly, NSW	100.00	"	"
David Edwards & Isabella Gray Edwards, RMB 1622, Jackson Road, Foster	100.00	"	"
Gareth Stuart Edwards, 83 Grey St, Carlton, NSW	100.00	"	"
Colin Edwards, "C A & M R Edwards S/F A/c", C/- Colin Edwards & Assoc, PO Box 468, Ashgrove, Qld	100.00	"	"
Helena Clare Edwards, 5/54A Darling Point Road, Darling Point, NSW	150.00	"	"
Mr Craig Edwards, 12/188 Bronte Road, Waverley, NSW	120.00	"	"
Mr Alexander Thomas Edwards, Apt 5A, 104 East 35th Street, New York – NY 10016 USA	108.00	"	"
Robyn Campbell Edwards & Elizabeth Anne Edwards, "The Edwards Super Fund A/c", C/- Ist Floor, 225 Chapel Street, Prahran	140.00	"	"
Tiang Heng Ee & Jenny Ee, 3/43 Megalong St, Nedlands, WA	100.00	"	"
Tiang Heng Ee, 3/43 Megalong Street, Nedlands, WA	100.00	"	"
Anthony J. Egan, Albert Street, Bendigo	240.00	"	28/04/00
Anthony J. Egan, Albert Street, Bendigo	300.00	"	27/10/00
Mr Michael Egan, PO Box 972, Mullumbimby, NSW	100.00	"	"
Samuel James Egger, 22 Jenner St, Seaforth, NSW	181.30	"	28/04/00
Egghead Software Computer Company Pty Ltd, PO Box 7339, Cloister Square, WA	123.45	"	"

Egghead Software Computer Company Pty Ltd, PO Box 7339, Cloister Square, WA	204.00	''	27/10/00
Julie Ann Ehmcke, "Ehmcke Family S/Fund A/c", 3/3 Bellevue Park Road, Bellevue Hill, NSW	120.70	''	28/04/00
Julie Ann Ehmcke, "Ehmcke Family S/Fund A/c", 3/3 Bellevue Park Road, Bellevue Hill, NSW	200.00	''	27/10/00
W. H. G. Ehmcke, 3/3 Bellevue Park Road, Bellevue Hill, NSW	100.00	''	''
Eight Penumbra Nominees Pty Limited, "Woodward Super Fund A/c", 3 Horsley Street, Bentleigh	200.00	''	''
Trevor Errol Eime & Anna Eime, Lot 9, Karwin Road, One Tree Hill, SA	120.00	''	28/04/00
Nilumi Ekanayake, 11 Argyle Street, Warrnambool	100.00	''	27/10/00
Sharon El-Makki, PO Box H139, Australia Square, NSW	100.00	''	''
Suraiyah Elahi, 5 Tennyson Drive, Delahey	100.00	''	''
Mrs Bernice Joy Elder, 32 Warragoon Crescent, Attadale, WA	120.00	''	''
Mr Verne William Elder, 32 Warragoon Crescent, Attadale, WA	120.00	''	''
Ms Sherrene Robin Elder, 32 Warragoon Crescent, Attadale, WA	100.00	''	''
Susan K. Eldridge, 6 Magazine Court, Ballarat	110.00	''	''
Strata Electrics, 14 Pondana Mews, Ballajura, WA	100.00	''	''
Elementary Watson Pty Ltd, 158 Hopetoun Avenue, Watsons Bay, NSW	150.00	''	''
Elenprom Pty Ltd, PO Box 176, Kew	104.00	''	''
Nora Eley, 32/6 McMaster Street, Victoria Park, WA	160.00	''	''
Thomas M. Elford, RMB 2165, Benalla	100.00	''	''
Sam J. Elias, 19a Blue Hills Crescent, Blacktown, NSW	140.00	''	''
Brendan James Elkington, 4 Uther Street, Carindale, Qld	100.00	''	''
Nancy Carra Elli, "Craig Carratelli A/c", 49 Santa Rosa Boulevard, Doncaster East	100.00	''	''
Joan Valda Ellingsen, 9 The Close, Frankston	140.00	''	''
Harry Ellingsen, 9 The Close, Frankston	140.00	''	''
Margaret Mary Elliot, 1 Kennedy Street, West Ipswich, Qld	120.00	''	''
Valerie Claire Elliott, 6 Courang Road, Glen Iris	120.00	''	''
Sandra Elliott, 1/26 St Georges Crescent, Drummoyne, NSW	120.00	''	28/04/00
Brian Elliott, Unit 1, 26 St Georges Crescent, Drummoyne, NSW	120.00	''	''
Anne Christina Elliott, 2/141 Kurraba Road, Neutral Bay, NSW	112.00	''	''
Anne Christina Elliott, 2/141 Kurraba Road, Neutral Bay, NSW	140.00	''	27/10/00
David William Elliott, L14/179 Elizabeth Street, Sydney, NSW	160.00	''	28/04/00
David William Elliott, L14/179 Elizabeth Street, Sydney, NSW	200.00	''	27/10/00
Ms Valerie Claire Elliott, 6 Courang Road, Glen Iris	100.00	''	''
Christopher John Elliott & Kellie Terese Elliott, 19 Garfield Street, Launceston, Tas.	100.00	''	''
Gary John Ellis & Gaylene Rae Ellis, PO Box 30, Pearcedale	140.00	''	''
Mrs Joan Stewart Ellis, 10B Dromorne Road, Remuera, Auckland, New Zealand	475.70	''	''

Lindsay Ellison, 19/2 Pacific Street, Bronte, NSW	100.00	''	''
Anne Marie Ellison & Gerard Craddock, 57 Wigram Road, Glebe, NSW	185.75	''	28/04/00
Anne Marie Ellison & Gerard Craddock, 57 Wigram Road, Glebe, NSW	308.00	''	27/10/00
Robert Andrew Ellison-Smith, 46 Ellsa St, North Balwyn	280.00	''	28/04/00
Robert Andrew Ellison-Smith, 46 Ellsa St, North Balwyn	350.00	''	27/10/00
Ms Maj-Lis Ellman, 55 Wedgebill Parade, Burleigh Waters, Qld	200.00	''	''
Elm Park Pty Ltd, "S Fund A/c", 106B/30 Campbell Street, Blacktown, NSW	300.00	''	''
Lee-Anne Elms, Lot 1, Clear Mountain Rd, Clear Mountain, Qld	100.00	''	''
Lee-Anne Elms & Murray Heath, Lot 1 Clear Mountain Rd, Clear Mountain, Qld	100.00	''	''
Lee-Anne Elms & Betty Heath & Murray Heath, Lot 1 Clear Mountain Rd, Clear Mountain, Qld	100.00	''	''
Janice Margaret Elsworth, 54-56 Sims Street, Sandringham	200.00	''	''
Barrie Elvish & Karen Elvish, 3 Lambeth Walk, Kings Park, SA	150.00	''	''
Barrie Elvish, 3 Lambeth Walk, Kings Park, SA	150.00	''	''
Rory Elwell-Sutton, 383 Swan Street, Richmond	225.60	''	28/04/00
Margot Joy Emanuel, 12 Auburn Road, Berala, NSW	120.70	''	''
Margot Joy Emanuel, 12 Auburn Road, Berala, NSW	200.00	''	27/10/00
Leslie Lynne Embersits, 4/28 New South Head Road, Vaucluse, NSW	200.00	''	''
Embros Pty Ltd, 62 Buckingham Street, Surry Hills, NSW	274.32	''	28/04/00
Embros Pty Ltd, 62 Buckingham Street, Surry Hills, NSW	342.90	''	27/10/00
Rosemarie Stephanie Emerson & Matthew Lee Emerson & Michaela Maree Emerson, 55 Hay Street, Tewantin, Qld	177.36	''	28/04/00
Rosemarie Stephanie Emerson & Matthew Lee Emerson & Michaela Maree Emerson, 55 Hay Street, Tewantin, Qld	221.70	''	27/10/00
Emmanuel Trust, Level 12/55 Clarence, Sydney, NSW	140.00	''	''
Toomsalu Endel, 14 Cann Street, Bass Hill, NSW	100.00	''	''
Mr P. Endre, PO Box 469, Bondi Junction, NSW	100.00	''	''
Mr Peter Endrey, PO Box 469, Bondi Junction, NSW	100.00	''	''
Mr Joseph Engel, 7 Marlin Terrace, Victor Harbor, SA	128.00	''	''
Alexis D. Von Harmann Engel, 2211 Cape McCan, Rockport, Texas 78382 USA	100.00	''	''
Margaret England, Waterline Howlong Road, Albury, NSW	192.00	''	28/04/00
Anne E. Englefield, Po Box 3384, Cedar	169.60	''	''
Anne E. Englefield, Po Box 3384, Cedar	212.00	''	27/10/00
Halyna English & Matthew Stephen English, 88 Third Avenue, Mount Lawley, WA	220.00	''	''
Willard Frances Enterprises, 73 Wood Street, Beechworth	100.00	''	''
Estate Beatrice Ellen M. Entwistle & Cyril Entwistle, C/-Bruce Petrie & Co Solicitor, 66 King St, Sydney, NSW	100.00	''	''
Alan Entwistle, 82 Australia Avenue, Umina, NSW	100.00	''	''
Udi Epstein, 11 Gerard Street, Caulfield	160.00	''	''
Jonathan Jacob Epstein & Rodney Epstein, 1 Hemingford Road, East Bentleigh	190.00	''	''
Suzanne Gail Erickson & Paul Erickson, 87 Lee Road, Winnmalee, NSW	100.00	''	''

Mark Hunter Erickson, 2 Birdvale Street, Taringa, Qld	140.00	''	''
Simon James Erskine, 35 St Leonards Avenue, West Leederville, WA	188.00	''	''
Erskine Estates Pty Ltd, 2/147 Kent Court, Toorak	240.00	''	28/04/00
Erskine Estates Pty Ltd, 2/147 Kent Court, Toorak	300.00	''	27/10/00
Mr Noel Esguerra, 11320 Mighty Oak Court, Orlando Florida 32821 USA	100.00	''	''
Eskimodowns Pty Ltd, "Super Fund A/c", Capital Creation, 221 Glenhantly Rd, Elsternwick	100.00	''	''
Esperanue Nominees Pty Ltd, "Johannsen Super Fund A/c", 103-113 Stanley Street, West Melbourne	240.00	''	28/04/00
Esperanue Nominees Pty Ltd, "Johannsen Super Fund A/c", 103-113 Stanley Street, West Melbourne	300.00	''	27/10/00
Janette Maree Etherington, 2/13 Maria Avenue, Nunawading	100.00	''	''
Leo Evangelista, 22 Gabriel Ave, Baulkham Hills, NSW	180.00	''	''
Allan William Evans, 26 Cahill Street, Dandenong	160.00	''	''
E. J. Evans & J. K. Evans, 7 Swallow Court, Patterson Lakes	100.00	''	''
Event Works Pty Ltd, 13 Erindale Avenue, Elsternwick	100.00	''	''
Elaine Everett, 30 Kennedy St, Melville, WA	100.00	''	''
David Evian & Shelley Rose Evian & David Evian Optometrist, PO Box 709, Crows Nest, NSW	120.00	''	''
Robert J, Ewens, 42 Mortlock Circuit, Kaleen, ACT	500.00	''	''
Mr Paul Robert Ewing, 32 Elizabeth St, Ashfield, NSW	160.00	''	28/04/00
Mr Paul Robert Ewing, 32 Elizabeth St, Ashfield, NSW	200.00	''	27/10/00
Executive Press Nom Pty Ltd, PO Box H58, Hurlstone Park, NSW	100.00	''	''
Mr Paul Anthony Ezzy, 11/82 Russell Terrace, Indooroopilly, Qld	160.00	''	''
F. M. D. Pty Ltd, 79 Welwyn Parade, Deer Park	100.00	''	''
Mr Paul Facey, 32 Derby Street, Highgate Hill, Qld	670.00	''	''
Nidai Fahri, 5 Toby Close, Razorback, NSW	200.00	''	''
Gregory Thomas Fahy, 4/167 Vincent St, North Perth, WA	100.00	''	''
Marlene Faint, 21 Bondell Avenue, Gymea, NSW	100.00	''	''
Fair-Trade Pty Ltd "Superannuation Fund A/c", 2/50 Assembly Drive, Tullamarine	436.00	''	''
Mr Robert Faircloth, Watercraft Venture, Bldg 3510, Rizal Highway, Subic Bay Freeport Zone, Subic Bay 2222	200.00	''	''
Fairlie Lloyd Pty Ltd, "The J. L. Friend Family A/c", 3 Bailey Street, Point Lonsdale	890.00	''	''
Mr Ernest Fajwul, PO Box 6602, Silverwater DC, NSW	100.00	''	''
Paul Richardson Fanshawe, 8 Ruby Street, Ormond	200.00	''	28/04/00
Mr James Farlow, 4 Selkirk Street, Tingalpa	100.00	''	27/10/00
Gregory Anthony Farmer, L13/99 Elizabeth Street, Sydney, NSW	100.00	''	''
Wayne Morris Farmer, 620 Weegen Road, Weegen, Tas.	100.00	''	''
Fee Leng Farn, 7 Max Forman Court, Como, WA	120.00	''	''
Timothy Michael Farndon, 18 Mary Street, Richmond	250.00	''	''
Shumaila Farooqui, 1/28 White Avenue, Bankstown, NSW	140.00	''	''
Scott Andrew Farquhar, 7/2 Hampden Ave, Cremorne, NSW	160.00	''	28/04/00
Scott Andrew Farquhar, 7/2 Hampden Ave, Cremorne, NSW	200.00	''	27/10/00

Mrs Patricia Margaret Farr, 8 Plummer Road, Mentone	170.00	”	”
Susanne Farrell, 37 Brian Avenue, Mount Pleasant, WA	256.00	”	28/04/00
Mr Brian Desmond Farrell, 4 Varzin Avenue, Surrey Hills	108.00	”	27/10/00
Mr Clive Christopher Farrelly, 3/3–5 Flood Street, Clovelly, NSW	110.00	”	”
Mr William Thomas Farrelly, PO Box 3281, Norman Park, Qld	150.00	”	”
Mr Andrew Charles Farriss & Mrs Shelley Margaret Farriss, 48 Flinders Avenue, St Ives, NSW	100.00	”	”
Dennis Leslie Farrugia, 6 Mulgowrie Crescent, Balgowlah Heights, NSW	100.00	”	”
Clive Murdoch Faul, “M R & H J Faul A/c”, PO Box 882, Wodonga	120.00	”	”
Mr William Favero, 7 Stewart Street, Parramatta, NSW	120.00	”	28/04/00
Daniel Eddie Favot, 34 Crieff Street, Ashbury, NSW	112.00	”	”
Faxback Australia Pty Ltd, “Staff Super Fund A/c”, PO Box 2232, Fitzroy	127.90	”	”
Faxback Australia Pty Ltd, “Staff Super Fund A/c”, PO Box 2232, Fitzroy	212.00	”	27/10/00
Anthoy John Fay, 16 Campbell Street, Birchip	100.00	”	”
Mr Greg Fearn, 314 Cliveden Avenue, Corinda, Qld	152.00	”	”
Robert Fearnley & Patricia Fearnley, “The Fearnley Property A/c”, 55 Santa Cruz Boulevard, Clear Island Waters, Qld	100.00	”	”
Michelle Featherstone, PO Box 1238, Eagle Farm Bc, Qld	100.00	”	”
Brian Feeley, 3040 Midland Hwy, Nalinga	100.00	”	”
Robert Loring Feeney, 76 Claremont Avenue, Malvern	100.00	”	”
Melanie C. Feez, PO Box 516, South Yarra	176.00	”	28/04/00
Melanie C. Feez, PO Box 516, South Yarra	220.00	”	27/10/00
Jane Feller, 82/177 Bellevue Road, Double Bay, NSW	100.00	”	”
Frank Feng & Yu Qin Feng, 8 Bristol Avenue, Pymble, NSW	188.00	”	”
Elaine Yu Feng, PO Box 154, Strawberry Hills, NSW	100.00	”	”
Mr Jeffrey Kevin Fennell & Ms Alison Juno Chalmer, 84 Shields Street, Flemington	100.00	”	”
Shelley Lola Fenton, 246 North Rocks Road, North Rocks, NSW	120.00	”	”
Shelley Lola Fenton & Damon James Thompson, 246 North Rocks Road, North Rocks, NSW	120.00	”	”
Mr Brec Alexander Fenton, 16 Picasso Crescent, Carseldine, Qld	185.00	”	”
Mr Sean Alexander Fenton, 45/4 New Mclean Street, Edgecliff, NSW	200.00	”	”
Dharsh Ferando, 11 Milford Avenue, Wheelers Hill	200.00	”	”
Mrs Sandra Fergeus, 26 Strickland Drive, Wheelers Hill	185.45	”	28/04/00
Petraí Shay Ferguson, 6 Furorie St, Sunnybank Hills, Qld	176.00	”	”
Petraí Shay Ferguson, 6 Furorie St, Sunnybank Hills, Qld	220.00	”	27/10/00
Mr Lawrence Ferguson, GPO Box 4422, Darwin, NT	120.00	”	”
Joanne Robyn Ferguson & Graham John Ferguson & Robert James Ferguson, 5A Fifth Avenue, St Peters, SA	300.00	”	”
Fermi Investments Pty Ltd, “Fermi Family A/c”, 113 Smith Street, Darwin, NT	100.00	”	”

Joseph Jumbo Fernandez, C/- Mrs J Manjiviona, 27 Holmbury Bvd, Mulgrave	120.00	''	''
Christine Fernandez, 184 Hargrave St, Paddington, NSW	482.35	''	28/04/00
Christine Fernandez, 184 Hargrave St, Paddington, NSW	800.00	''	27/10/00
Warren F. Fernandez, 20 Wesley Drive, Narre Warren	140.00	''	''
Irene Cecilia Fernando. 15 Downey Drive, Manning, WA	120.70	''	28/04/00
Irene Cecilia Fernando, 15 Downey Drive, Manning, WA	200.00	''	27/10/00
John Fernon, 37 Baroona Road, Northbridge, NSW	248.00	''	''
Christopher Nicholas Feros, 27 Gow Avenue, Port Hacking, NSW	100.00	''	''
Vincent Ferrara, 47 Phoebe Street, Islington, NSW	100.00	''	''
Mr Anton Lawrence Ferrari & Mrs Monique Elizabeth Ferrari, 1/44 Eric Street, Como, WA	100.00	''	''
Ferrari Enterprises Pty Ltd, "Bouffier Family A/c", 53 Welwyn Avenue, Manning, WA	100.00	''	''
Filipe Sousa Ferraz, 15 Barton Street, Mount Isa, Qld	128.00	''	28/04/00
Filipe Sousa Ferraz, 15 Barton Street, Mount Isa, Qld	160.00	''	27/10/00
Filipe Sousa Ferraz & Sandra Sousa Ferraz, 15 Barton Street, Mount Isa, Qld	132.85	''	28/04/00
Filipe Sousa Ferraz & Sandra Sousa Ferraz, 15 Barton Street, Mount Isa, Qld	220.00	''	27/10/00
Manuel Antonio Dias Ferraz, 15 Barton St, Mount Isa, Qld	100.00	''	''
Raymond W. Ferry, 14 Cope Street, Hamersley, WA	200.00	''	28/04/00
Raymond W. Ferry, 14 Cope Street, Hamersley, WA	250.00	''	27/10/00
Fertha View Pty Ltd, 21 Manning Road, Malvern East	128.00	''	28/04/00
Fertha View Pty Ltd, 21 Manning Road, Malvern East	160.00	''	27/10/00
Mr Joseph Feychell, 25 Birchwood Boulevard, Hoppers Crossing	140.00	''	''
Fidura Pty Limited, C/- Powell Kwok & Co, Level 7, 350 Kent Street, Sydney, NSW	384.00	''	28/04/00
Fidura Pty Limited, C/- Powell Kwok & Co, Level 7, 350 Kent Street, Sydney, NSW	480.00	''	27/10/00
Fidura Pty Ltd, C/- Powell Kwok & Co, Level 7, 350 Kent Street, Sydney, NSW	134.40	''	28/04/00
Fidura Pty Ltd, C/- Powell Kwok & Co, Level 7, 350 Kent Street, Sydney, NSW	168.00	''	27/10/00
Elizabeth Fiegert, 2/77 Dolphin Street, Coogee, NSW	100.00	''	''
Janette Virginia Field & Robert Hugh Haywood, Matlock, PO Box 118, Mount Macedon	100.00	''	''
Mr Richard Anthony Field, PO Box 159, Yerecoin, WA	120.00	''	''
Simon Wares Fieldhouse, PO Box 949, Pymble, NSW	181.30	''	28/04/00
Daniel Fielding, 61 Nimmo Street, Middle Park	128.00	''	27/10/00
John Austin Fienieg, 5 Sybil Street, Newport, NSW	181.30	''	28/04/00
John Austin Fienieg, 5 Sybil Street, Newport, NSW	300.00	''	27/10/00
MR Gerald Edward Figg & Mrs Kay Lynn Figg, 5 Grevillea Street, Wulguru, Qld	100.00	''	''
Judith File, 3 Kellys Esplanade, Northwood, NSW	179.20	''	28/04/00
Filekit Pty Limited, "Tom Keck Super Fund A/c", 6/108 Bilyana Street, Balmoral, Qld	160.00	''	27/10/00
Lloyd Filer & Catherine Filer, 8 Explorers Court, Vermont South	100.00	''	''
Alvise Filippi, 113 Bellevue Road, Figtree, NSW	240.00	''	28/04/00

Financial Success Planning Pty Ltd, "Finance Success Planning A/c", 71 Plateau Road, Bilgola Plateau, NSW	192.00	"	"
Financial Success Planning Pty Ltd, "Finance Success Planning A/c", 71 Plateau Road, Bilgola Plateau, NSW	240.00	"	27/10/00
Ms Sharen Fink, 20 Carters Avenue, Toorak	500.00	"	"
Russell Charles Finlay & Richard Stephen Weston & Management Recruiters P/L, 19 Agnes St, East Melbourne	168.00	"	"
Mr Victor Finn & Mrs Helen Finn, 320 Whitehall Street, Yarraville	304.00	"	28/04/00
Mr Victor Finn & Mrs Helen Finn, 320 Whitehall Street, Yarraville	380.00	"	27/10/00
Mrs Johanna Margaretha Finnholm, 12/7 O'Brien Street, Bondi Beach, NSW	230.00	"	"
Mark Alan Finnigan, 28/18 Drummoyne Avenue, Drummoyne, NSW	100.00	"	"
Mrs Judith Anne Firman, C/- Truman Dawson, 6/490 Bourke Street, Melbourne	332.00	"	"
Neil Alexander Firth, PO Box 9, Hahndorf, SA	200.00	"	28/04/00
Neil Alexander Firth, PO Box 9, Hahndorf, SA	250.00	"	27/10/00
Robert Henry Firth, Lot No 4 Creek Road, Currumbin, Qld	133.28	"	28/04/00
Robert Henry Firth, Lot No 4 Creek Road, Currumbin, Qld	166.60	"	27/10/00
Rosemary Fisher, 19 Station Street, Pymble, NSW	100.00	"	"
Richard Fisher, 59 Carlingford Rd, Epping, NSW	120.00	"	"
Raymond Valentine Fisher, 3/15 St Leonards Court, South Yarra	140.00	"	"
Mavis Phyllis Fitton, 126 Frank Street, Labrador, Qld	108.60	"	28/04/00
Mary Helen Fitzgerald, 10 Rowena Place, Cherrybrook, NSW	150.00	"	27/10/00
Gregory Fitzgerald, 24A Alkaringa Road, Yowie Bay, NSW	100.00	"	"
Dawn Fitzgerald, 24A Alkaringa Road, Yowie Bay, NSW	100.00	"	"
Scott David Fitzgerald, 28 Willow Grove, East Kew	120.00	"	28/04/00
Scott David Fitzgerald, 28 Willow Grove, East Kew	150.00	"	27/10/00
Colleen Michelle O'Connor, John Edward Fitzgerald, C/- Ms M. O'Connor, 5 Grahame Street, Devonport – Auckland, New Zealand	660.00	"	"
Anthony John Fitzgerald & Susan Joy Fitzgerald, 5 Friar Place, Ingleburn, NSW	100.00	"	"
Mr Peter Fitzgerald & Neil Price & Maurice Gallen, PO Box 1574, Byron Bay, NSW	100.00	"	"
John M Fitzgerald, PO Box 532, Nambour, Qld	250.00	"	"
John Edward Fitzgibbon & Barbara Ellen Fitzgibbon, PO Box 2070, Mildura	200.00	"	"
Daniel Fitzgibbons, 31A Berkeley St, Speers Point, NSW	260.00	"	"
Fitzwood Pty Ltd, PO Box 1175, Collingwood	108.60	"	28/04/00
Fitzwood Pty Ltd, PO Box 1175, Collingwood	180.00	"	27/10/00
Fiveline Pty Ltd, PO Box 161 Goraki, 120 Spingville Road, Coraki, NSW	416.00	"	28/04/00
Jessie Flaherty, 133 Konyung Road, Mount Eliza	100.00	"	27/10/00
William Flannery, PO Box 47, Canowindra, NSW	100.00	"	"
B. Fletcher, "Baryn Emp Prov Fund A/c", Sequester Quays, 25 Morala Avenue, Runaway Bay, Qld	160.00	"	28/04/00
Claudia Fleuten, 3 Altarnun Road, Langwarrin	100.00	"	27/10/00

FLH Nominees Pty Ltd, "Blue Star Super A/c", Suite 102, 370 Pitt Street, Sydney, NSW	362.15	"	28/04/00
FLH Nominees Pty Ltd, "Blue Star Super A/c", Suite 102, 370 Pitt Street, Sydney, NSW	600.00	"	27/10/00
Geoffrey Alan Flick, 18D Phillip Street, Sydney, NSW	181.30	"	28/04/00
Geoffrey Alan Flick, 18D Phillip Street, Sydney, NSW	300.00	"	27/10/00
Flinders NSW Pty Ltd, 1 Caledonia Street, Paddington, NSW	100.00	"	"
John Flint, 11 Romilly Street, Peakhurst, NSW	100.00	"	"
Mr Liam Damien Flood, 127 Duncan St, Maroubra, NSW	100.00	"	"
Alan Anthony Flores, 51 Bundeena Road, Woodbine, NSW	100.00	"	"
Paul Thomas Florian, PO Box 1055, Oxley, Qld	126.75	"	28/04/00
Paul Thomas Florian, PO Box 1055, Oxley, Qld	210.00	"	27/10/00
Beverley Florida & Robert Florida, 16 Lukas Avenue, Kenthurst, NSW	352.00	"	"
John Francis Flynn, 4/21 Dunbar Terrace, Glenelg East, SA	100.00	"	"
Foigea Investments & John Fois & Stephen Geagea, 38 Kerr Street, Fitzroy	120.00	"	"
Joan Shirley Foley & Timoty Foley, 13 Moseley Street, Port Hedland, WA	260.00	"	"
Luke Adrian Follett, PO Box 675, Robinvale	100.00	"	"
Elizabeth Foo, 29 Park Drive, Parkville	140.00	"	"
Ahkow Foo, 1198 Centre Road, Clayton South	140.00	"	"
Matthew Ted Phin Foo, 450 Botany Rd, Alexandria, NSW	182.40	"	28/04/00
Matthew Ted Phin Foo, 450 Botany Rd, Alexandria, NSW	228.00	"	27/10/00
Foodex Pty Ltd, Suite 1, 208 St Andrews Street, Brighton	500.00	"	"
Foodtex Pty Ltd, PO Box 1047, North Fitzroy	100.00	"	"
Peter Richard Forbes, 302 Balcombe Road, Beaumaris	100.00	"	"
Douglas Kenneth Ford & Denise Joy Ford, 3 The Ridge, Lilydale	100.00	"	"
Colleen Ann Ford, Post Office, Coolup, WA	100.00	"	"
Jon Ford, PO Box 46, Annerley, Qld	220.00	"	"
Mr Glenn Ford, "Mr G. Ford Super Fund A/c", 6-12 Gordon Street, West Perth, WA	352.25	"	28/04/00
Mr Glenn Ford, "Mr G. Ford Super Fund A/c", 6-12 Gordon Street, West Perth, WA	584.00	"	27/10/00
Michael John Ford, 86 Jerrang Street, Indooroopilly, Qld	100.00	"	"
Fordyce Investments Pty Limited, PO Box 404, Wahroonga, NSW	112.00	"	"
Henry Alan Forman & Sarah Jane Foreman, "Henry Alan Forman A/c", 24/92 Guineas Creek Road, Currumbin, Qld	120.00	"	"
Ian Forman, 71 Iberia Street, Padstow, NSW	151.00	"	28/04/00
Mr Donald Forrest & Mrs Marie Forrest, "D & M Forrest Super Fund Ac", C/-Trustwest, PO Box 809, Stirling, WA	120.70	"	"
Mrs Helen Wendy Forrester, 3 Wood St, Eastwood, NSW	400.00	"	27/10/00
Mr Tony Matthew Forsyth, 25 Ranelagh Crescent, South Perth, WA	316.80	"	28/04/00
Mr Tony Matthew Forsyth, 25 Ranelagh Crescent, South Perth, WA	396.00	"	27/10/00
Fortfirst Yeneb Pty Ltd, 2113 Coimadai Road, Toolern Vale	140.00	"	"

Victor Foruria & Angelina Lucia Foruria, PO Box 5363, Bundaberg West, Qld	100.00	''	''
Miss Hannah Foster, 6 Caughley Crescent, Waiouru, NZ	132.10	''	''
Mr Samuel Foster, 6 Caughley Crescent, Waiouru, NZ	132.10	''	''
Lesley Ann Foster, 18 Lightfoot Street, Mont Albert	100.00	''	''
Mr Gary Fouche, 2/26 Ebden Street, Brighton	120.00	''	''
Andrew Kenneth Foulstone, 17 O'Shanassy Street, North Melbourne	169.60	''	28/04/00
Rex Fox, 19 High Street, Trentham	104.00	''	''
Rex Fox, 19 High Street, Trentham	130.00	''	27/10/00
Est Ivan Alan Fox, 20 Sulman Place, Phillip, ACT	110.00	''	''
Elise Foxworth, 4/29 Raglan Street, St Kilda East	100.00	''	''
Douglas Michael Franc, 3 The Crescent, Mosman, NSW	120.70	''	28/04/00
Caroline Margaret Francis, 68 Carabella St, Kirribilli, NSW	132.85	''	''
Perry G. Franich, 69 Roycroft Avenue, Mill Park	176.00	''	''
Perry G. Franich, 69 Roycroft Avenue, Mill Park	220.00	''	27/10/00
Jacqueline Aziza Frank, 67 Ruthven St, Bondi Junction, NSW	100.00	''	''
Franklin Dell Pty Ltd, 265A Springvale Rd, Glen Waverley	390.00	''	''
Franklin Dell Pty Ltd, PO Box 1309, Mount Waverley	250.53	''	28/04/00
Franklin Dell Pty Ltd, PO Box 1309, Mount Waverley	415.60	''	27/10/00
Ms Catherine Louise Franks & Ms Lynda Jane Franks, Tolmer Place, Norwood, SA	301.55	''	28/04/00
Tonino Franze, 90 West Street, Hurstville, NSW	120.00	''	''
Tonino Franze, 90 West Street, Hurstville, NSW	150.00	''	27/10/00
Erick Valentin Franzen, Unit 14, 14 Queen Street, King's Beach, Qld	122.60	''	''
Rose-Marie Fraser, Hansen Yuncken, Level 3, 33-35 Belmont Street, Sutherland, NSW	100.00	''	28/04/00
Rosemary Gaye Frazer, 2 Prince Street, Forbes, NSW	150.00	''	27/10/00
Colin Fredericks, PO Box 81, Hamilton Hill, WA	260.00	''	''
Ms Janette Free, 18 Panorama Crescent, Cooee, Tas.	110.00	''	''
Mr John Peter Freeman, 60 Sunnybank Road, Langwarrin	100.00	''	''
Ms Catherine Freestone & Mr Brendon Kirby, 2nd Floor/104A Priory Road, West Hampstead, London NW6 3NS United Kingdom	110.85	''	28/04/00
Ms Catherine Freestone & Mr Brendon Kirby, 2nd Floor/104a Priory Road, West Hampstead, London NW6 3NS United Kingdom	150.00	''	27/10/00
Alan French, 85 Hochstrasse, Basel, Switzerland Ch 4053	178.84	''	28/04/00
Alan French, 85 Hochstrasse, Basel, Switzerland Ch 4053	242.00	''	27/10/00
Helen French, "French Property U Nit A/c", Moorillah Property, Monaro Highway, Chakolah, NSW	100.00	''	''
Jacqueline Therese French, 1/11 Stuart Street, Manly, NSW	198.40	''	28/04/00
Jacqueline Therese French, 1/11 Stuart Street, Manly, NSW	248.00	''	27/10/00
Ms Natasha Cheree Freney, 38 Drayton Avenue, Castle Hill, NSW	100.00	''	''
Robina Yvonne Frew, 30 Willowtree Crescent, Belrose, NSW	200.00	''	''
Mr Robert Friedman, 5 Lynedoch Avenue, St Kilda East	100.00	''	''
William Sidney Friend, C/- Post Office, Mapleton, Qld	100.00	''	''
Frontline Systems Australia Pty Ltd, PO Box 3272, Pymble, NSW	181.30	''	28/04/00
Frontline Systems Australia Pty Ltd, PO Box 3272, Pymble, NSW	300.00	''	27/10/00

Yolande Frost, 4 Wellesley Street, Mont Albert	100.00	''	''
Antonia Froutzis, 3 Flowerdrum Close, Templestowe	250.00	''	''
Mr Thomas Richard Fry & Mrs Nicole Maria Fry, C/- Tom Fry, JB Were, GPO Box 5264, Sydney, NSW	108.00	''	''
Mr Steven Fryer, GPO Box 1838Q, Melbourne	272.00	''	''
Roger Chong - Chi Fu, 145/1 Queensberry St, Carlton	206.40	''	28/04/00
Roger Chong - Chi Fu, 145/1 Queensberry St, Carlton	258.00	''	27/10/00
Kent Fu, 145/1 Queensberry Street, Carlton	125.65	''	28/04/00
Kent Fu, 145/1 Queensberry Street, Carlton	208.00	''	27/10/00
Hsieh Mei Lan Fu, 145/1 Queensberry St, Carlton	206.40	''	28/04/00
Hsieh Mei Lan Fu, 145/1 Queensberry St, Carlton	258.00	''	27/10/00
Patricia Ann Fuary, 115 Schlich Street, Yarralumba, ACT	100.00	''	''
Mr Douglas Gordon Fuller, PO Box 135, Kallangur, Qld	150.00	''	''
Mrs Alison Fuller, 17 Kingfisher Street, Dubbo, NSW	100.00	''	''
Robert Stanley Fuller, 18 Arana, Manly Vale, NSW	100.00	''	''
Nigel Stewart John Fuller, 1/12 Clifford Avenue, Fairlight, NSW	140.00	''	''
Kuei Fung, GPO Box 3844, Sydney, NSW	152.15	''	28/04/00
Kuei Fung, GPO Box 3844, Sydney, NSW	252.00	''	27/10/00
Choi Luen Fung, GPO Box 3844, Sydney, NSW	152.15	''	28/04/00
Choi Luen Fung, GPO Box 3844, Sydney, NSW	252.00	''	27/10/00
Kuei Fung, Shop D3, Sussex Centre, 60 Dixon Street, Sydney, NSW	181.30	''	28/04/00
Kuei Fung, Shop D3, Sussex Centre, 60 Dixon Street, Sydney, NSW	300.00	''	27/10/00
Choi Luen Fung, Shop D3, Sussex Centre, 60 Dixon Street, Sydney, NSW	185.75	''	28/04/00
Choi Luen Fung, Shop D3, Sussex Centre, 60 Dixon Street, Sydney, NSW	308.00	''	27/10/00
Mr Kuei Fung & Mrs Choi Luen Fung, 131 Gale Road, Maroubra, NSW	301.55	''	28/04/00
Mr Kuei Fung & Mrs Choi Luen Fung, 131 Gale Road, Maroubra, NSW	500.00	''	27/10/00
Ha Shee Fung, 77 Mason Street, Maroubra, NSW	176.00	''	28/04/00
Ha Shee Fung, 77 Mason Street, Maroubra, NSW	220.00	''	27/10/00
Choi Luen Fung, 131 Gale Road, Maroubra, NSW	207.80	''	28/04/00
Choi Luen Fung, 131 Gale Road, Maroubra, NSW	344.00	''	27/10/00
Kuei Fung, 131 Gale Road, Maroubra, NSW	207.80	''	28/04/00
Kuei Fung, 131 Gale Road, Maroubra, NSW	344.00	''	27/10/00
Choi Luen Fung, Shop 41-43, Level One QVB, 455 George Street, Sydney, NSW	185.75	''	28/04/00
Choi Luen Fung, Shop 41-43, Level One QVB, 455 George Street, Sydney, NSW	308.00	''	27/10/00
Kuei Fung, Shop 41-43, Level One QVB, 455 George Street, Sydney, NSW	185.75	''	28/04/00
Kuei Fung, Shop 41-43, Level One QVB, 455 George Street, Sydney, NSW	308.00	''	27/10/00
Kuei Fung & Choi Luen Fung, 131 Gale Road, Maroubra, NSW	113.55	''	28/04/00
Kuei Fung & Choi Luen Fung, 131 Gale Road, Maroubra, NSW	188.00	''	27/10/00
Fung Pacific Pty Ltd, 131 Gale Road, Maroubra, NSW	904.65	''	28/04/00
Fung Pacific Pty Ltd, 131 Gale Road, Maroubra, NSW	1,500.00	''	27/10/00

Victoria Rozel Funnell, "William Funnell A/c", 45 Dorrington Avenue, Glen Iris	120.00	"	"
Ms Holly Furness, TCP No 5122, Dymocks Building, 428 George Street, Sydney, NSW	160.00	"	28/04/00
Ms Holly Furness, TCP No 5122, Dymocks Building, 428 George Street, Sydney, NSW	200.00	"	27/10/00
Estate Roslyn Naomi Furse, 4/24 Rangers Road, Cremorne, NSW	300.00	"	"
Paul Justin Fyson, 288 Williams Road, Toorak	120.00	"	"
G C C K Pty Ltd, 658 Church Street, Richmond	4,350.00	"	"
G W Symons Nominees Pty Ltd, PO Box 74, Walkerville, SA	100.00	"	"
Alexander Gabriel, 21 Urquhart Street, Hawthorn,	100.00	"	"
John Gaffey, 34 Bunday Street, Magill, SA	160.00	"	28/04/00
John Gaffey, 34 Bunday Street, Magill, SA	200.00	"	27/10/00
Mervyn Paul Galea, PO Box 608, Wentworthville, NSW	100.00	"	"
Prudence Francis Galea, 360 Oligvie Avenue, Echuca	112.00	"	28/04/00
Prudence Francis Galea, 360 Oligvie Avenue, Echuca	140.00	"	27/10/00
Edward Anthony Gallagher, 13/21 Alison Road, Kensington, NSW	200.10	"	28/04/00
Edward Anthony Gallagher, 13/21 Alison Road, Kensington, NSW	332.00	"	27/10/00
Mr Michael Saverio Gallenti & Mrs Belinda Gae Gallenti, 18 Russell St, Caulfield South	100.00	"	"
Ross Andrew Gallienne, 39 Amaroo Street, Chadstone	120.70	"	28/04/00
Joy Gan, 1001/221 Sturt Street, Southbank	140.00	"	27/10/00
Hok Mo Gan, Po Box 1520, Macquarie Centre, NSW	100.00	"	"
Gananan Pty Ltd, 3/7 Boston Road, Balwyn	100.00	"	"
Ganimp Pty Ltd, "B. & B. Superfund Account", 60 Perry Street, Matraville, NSW	200.00	"	"
Lynne Edmonston Gannon, 47 Sutherland Road, Plenty	100.00	"	"
Mr Ralph Garbers, 26 Grange Road, Frankston	100.00	"	"
Mr Ralph Garbers, "Super Fund A/c", 26 Grange Road, Frankston	158.90	"	28/04/00
Warren Christopher Gardiner, 9 Jackaman Street, Bondi, NSW	140.00	"	27/10/00
Estate Richard Gardiner, 40 Rupert Street, Subiaco, WA	100.00	"	"
Ricki Gardiner, 40 Rupert Street, Subiaco, WA	100.00	"	"
Miss Natalie Jane Gardiner, 19 Aroona Crescent, Terranora, NSW	144.00	"	28/04/00
Miss Natalie Jane Gardiner, 19 Aroona Crescent, Terranora, NSW	180.00	"	27/10/00
Mr David Linton Gardiner, "Vertex Fund A/c", PO Box 52, Richmond	100.00	"	"
Ross Graham Gardyne, 8/9 Murray Street, Lane Cove, NSW	120.00	"	"
Michael Joseph Garimort, PO Box 272, Parap, NT	140.00	"	"
Lisa Karen Garland & Timothy James Garland, 60 Fairway Drive, Casino, NSW	100.00	"	"
Phil Garlic, PO Box 349, Carmavon, WA	120.00	"	"
Phillip Norman Garlick, PO Box 349, Carnarvon, WA	160.00	"	"
David John Garnett & Leonie Kathleen Garnett, 7 Walkington Avenue, Margaret River, WA	200.00	"	"

John Joseph Garnsey, Level 62 MLC Centre, Martin Place, Sydney, NSW	327.00	''	''
Benjamin Nigel Garrett, C/- Perpetual Trustee, 30 Hunter Street, Sydney, NSW	190.00	''	''
Bruce Robert Garrison, 17 Barnsbury Road, Deepdene Garry Fair Car Sales Pty Ltd, "Super Fund A/c", 318 Wagga Road, Lavington, NSW	200.00	''	''
Mr Brian Jack Garstang, 4/13 Small Street, Hampton	150.00	''	''
Michael James Gascoigne, 28 Lexton St, Stretton, Qld	100.00	''	''
Max Gaskin & Sandra Gaskin, 39 Rathmullen Rd, Boronia Gaspar Investments Pty Ltd, "The D. Gaspar A/c", 89 Edgevale Road, Kew	120.00	''	''
Mr Brian Michael Gaudry, 158 Alfred St, Narraweena, NSW	138.90	''	28/04/00
Mr Brian Michael Gaudry, 158 Alfred St, Narraweena, NSW	212.00	''	''
Robert Theodore Gauld, 19 Rochester Terrace, Normanby, Qld	265.00	''	27/10/00
Robert Theodore Gauld, 19 Rochester Terrace, Normanby, Qld	182.40	''	28/04/00
Robert Theodore Gauld, 19 Rochester Terrace, Normanby, Qld	228.00	''	27/10/00
Earnest James Gault, 18 Hill Street, Bega, NSW	112.00	''	28/04/00
Earnest James Gault, 18 Hill Street, Bega, NSW	140.00	''	27/10/00
Mr Peter Gavin, 5/12 St James Road, Armadale	120.70	''	28/04/00
Janice S. Gaynor, 484 Koorringal Road, Wagga Wagga, NSW	200.00	''	''
Janice S. Gaynor, 484 Koorringal Road, Wagga Wagga, NSW	250.00	''	27/10/00
Sarah Gazia, 7 Dean Street, Kew	128.00	''	28/04/00
Sarah Gazia, 7 Dean Street, Kew	160.00	''	27/10/00
GC (T) Pty Ltd, "Morton Family A/c", 398 Jackson Road, Sunnybank Hills, Qld	100.00	''	''
GC Securities Pty Limited, "The Bungan Super A/c", C/- MGC Financial Management, GPO Box 4265, Sydney, NSW	800.00	''	28/04/00
GC Securities Pty Limited, "The Bungan Super A/c", C/- MGC Financial Management, GPO Box 4265, Sydney, NSW	1,000.00	''	27/10/00
GC Securities Pty Limited, "Jones Family A/c", C/- MGC Financial Management, Limited, GPO Box 4265, Sydney, NSW	560.00	''	28/04/00
Mr Julius Paul Gedey, 170 Hotham Street, East Melbourne	100.00	''	27/10/00
Ibrahim Adam Geha & John Peter Adam Geha, 1/34 Mary Street, Como, WA	140.00	''	''
Norma Elaine Gelder & Raymond Thomas Gelder, Kalina Weelsby Park Drive, Cawdor, NSW	240.00	''	28/04/00
Norma Elaine Gelder & Raymond Thomas Gelder, Kalina Weelsby Park Drive, Cawdor, NSW	300.00	''	27/10/00
GEM Investigations Pty Ltd, C/- Mr T Seymour, PO Box 181, Umina, NSW	130.00	''	''
Carmelo Salvatore Genovese, 93 Hayes Avenue, Dianella, WA	100.00	''	''
Geojac Pty Ltd, 12 Third Avenue, St Peters, SA	400.00	''	27/10/00
Mary George, 17 Forest Glen, Cherrybrook, NSW	120.70	''	28/04/00
Mary George, 17 Forest Glen, Cherrybrook, NSW	200.00	''	27/10/00
Miss Renay Cara George, 29/2-10 Quarrymaster Drive, Pyrmont, NSW	112.00	''	''
George Antony Georgiou, PO Box 969, Alice Springs, NT	100.00	''	''
Natasha Georgius, 44 Richer Street, Toowong, Qld	100.00	''	''

James Philip Gerhardy & Janette Ann Gerhardy, 35 Edgeworth Street, Prospect, SA	120.00	''	28/04/00
Mr Ian Gerrard, 7731 Falstaff Rd, McLean VA 22102, USA	125.63	''	''
Margaret Gettingby, 467 North Beach Road, Gwelup, WA	190.00	''	27/10/00
Edward Gettingby, 467 North Beach Road, Gwelup, WA	190.00	''	''
Ms Margaret Gettingby, "Jason Gettingby A/c", 467 North Beach Road, Gwelup, WA	110.00	''	''
Michael Geuder, "Kirsten Lee Geuder A/c", Po Box 11, Baulkham Hills, NSW	337.90	''	28/04/00
Michael Geuder "Kirsten Lee Geuder A/c", Po Box 11, Baulkham Hills, NSW	560.00	''	27/10/00
Mary Gharib, 46A Evans St, Fairfield Heights, NSW	100.00	''	''
Shahrzad Ghayomian, 9/10 Epping Road, Lane Cove, NSW	120.70	''	28/04/00
Shahrzad Ghayomian, 9/10 Epping Road, Lane Cove, NSW	200.00	''	27/10/00
Miss Lily Ghraiche, 33 Maxim Street, West Ryde, NSW	120.00	''	''
Antonio R. Giacomantonio, LMB 3537, Brisbane, Qld	188.50	''	28/04/00
Antonio R. Giacomantonio, LMB 3537, Brisbane, Qld	312.00	''	27/10/00
Norman Gianatti, Lot 84, West Swan Rd, West Swan, WA	100.00	''	''
Ronald Roy Gibbins, 41 Loch Lomond Drive, Modbury, SA	100.00	''	''
John A. Gibbons & Leonie B. Gibbons, 15 Nirranda Street, Concord West, NSW	100.00	''	''
Peter Cyril Gibbs & Karin Bartels, 8 Faulkner Street, Hampton	120.00	''	''
Stephen Abel Gene Gibellini, 61 Pavetta Crescent, Forrest Field, WA	169.20	''	28/04/00
Stephen Abel Gene Gibellini, 61 Pavetta Crescent, Forrest Field, WA	280.00	''	27/10/00
Julianne Gibson, 29 Sutherland Road, Armadale	100.00	''	''
Gilarth Pty Ltd, "Gilarth Staff S/Fund A/c", 24 Talbot Avenue, St Kilda East	157.05	''	28/04/00
Gilarth Pty Ltd, "Gilarth Staff S/Fund A/c", 24 Talbot Avenue, St Kilda East	260.00	''	27/10/00
James Gilbert, 9 Penrhyn Avenue, Burwood	140.00	''	''
Arthur Laurence Gilbert, 24 Cordeaux St, Hill End, Qld	100.00	''	''
Mr Lee Joseph Gilbertson, 51 Clydesdale St, Como, WA	100.00	''	''
Ms Rebecca Gilboa, Akasaka Park Building, 2-20 Akasaka 5-Chome, Minato-Ku Tokyo 107-6151 Japan	147.80	''	28/04/00
Ms Rebecca Gilboa, Akasaka Park Building, 2-20 Akasaka 5-Chome, Minato-Ku Tokyo 107-6151, Japan	200.00	''	27/10/00
Gilead Pty Ltd, 32 Princess Street, Kew	217.60	''	28/04/00
Kathleen Giles, 31 Willis Street, Gordon Park, Qld	120.00	''	27/10/00
George William Gill & Joan B. Gill & First Novtex Pty Ltd, "Super Fund A/c", 6 Vernon Avenue, West Heidelberg	100.00	''	''
Malcolm Royce Dodds Gill, 379 Lygon Street, Carlton	100.00	''	''
Anke Gill, 17 B Tower 2 Euston Court, 6 Park Road, Midlevels Hong Kong Sar	100.00	''	''
Margaret Celeste Gillard, 125 Overport Road, Frankston	120.00	''	''
Graham Robert Gillard, 125 Overport Road, Frankston	120.00	''	''
Mr Bruce Gillett & Mrs Jill Gillett, GPO Box 1598, Brisbane, Qld	500.00	''	''
Mr Craig Gillette, 1/222 Walsh Street, South Yarra	140.00	''	''
Mr Barry David Gillette, 7 Cawoor Place, Rosemeadow, NSW	120.00	''	''

Sarah Jane Gillingham, 45 Bradleys Head Road, Mosman, NSW	192.95	''	28/04/00
Sarah Jane Gillingham, 45 Bradleys Head Road, Mosman, NSW	320.00	''	27/10/00
Mr Paul Graham Gillis, 58A Pleasant Avenue, Glandore, SA	110.00	''	''
Mr Joel Gillman, 5021 47th Avenue, S W Seattle, Washington 98136 USA	148.00	''	''
Gillon Construction Pty Ltd, 29 Bundeena Avenue, Kealba	100.00	''	''
Gillon Construction Pty Ltd, "Kotev Superannuation Fund", C/ Cerantonio & Salvalagio, 47 McIntyre Rd, North Sunshine	100.00	''	''
John Stanley Gillroy, PO Box 708, Strawberry Hills, NSW	140.00	''	''
Edward J. Gilmour, 9 Garrick Terrace, Herston, Qld	300.00	''	''
Dean L. Gingell, 5 Napier Street, Lindfield, Nsw	250.00	''	''
Rohan Ginnane, 111 Sternberg Crescent, Wanniasa, ACT	100.00	''	''
Estate Giovanni Gioia, 129 Avenue Road, Mosman, NSW	100.00	''	''
Jasmin Gioskos, 34 Bird Street, Deer Park	140.00	''	''
Jasmin Gioskos, 34 Bird Street, Deer Park	140.00	''	''
Claire Girdler, 45 Essey Street, Wembley, WA	180.00	''	''
John Gismondi, 8 Hadley Close, Kealba	100.00	''	''
Gita Investments Pty Ltd, Level 2, 111 Collins Street, Melbourne	640.00	''	28/04/00
Gita Investments Pty Ltd, Level 2, 111 Collins Street, Melbourne	800.00	''	27/10/00
Gita Investments Pty Ltd, Level 2, 111 Collins Street, Melbourne	640.00	''	28/04/00
Gita Investments Pty Ltd, Level 2, 111 Collins Street, Melbourne	800.00	''	27/10/00
Mr Hans Gitmans, 18 Rangitirna Avenue, Takapuna, Auckland, New Zealand	800.00	''	''
Sebastian Lo Giudice, 10 Longview Road, North Balwyn	113.55	''	28/04/00
Mr Gamal Giurgius, PO Box 3110, Parramatta, NSW	104.00	''	27/10/00
Mr Gamal Giurgius, "Mary Giurgius A/c", PO Box 3110, Parramatta, NSW	104.00	''	''
Julie Glanvill, 7 Mulheran Ave, Wentworth Falls, NSW	220.00	''	''
Leonard Matthew Gleeson & Est Teresa Johanna Gleeson, "LM & TJ Gleeson Ret Farmrs A/c", 80 Darley Circle, Bull Creek, WA	100.00	''	''
Estate Marlene Ann Gleeson, 2 Almurta Rd, East Bentleigh	288.00	''	28/04/00
Mr James Anthony Gleeson, C/- First Pacific Stockbrokers, Level 31 Gateway, 1 Macquarie Place, Sydney, NSW	100.00	''	27/10/00
Ms Michelle Rose Gleeson, Spring Grove Mail Service 979, Monto, Qld	100.00	''	''
Scott Robert Glendinning, 16 Richardson Terrace, Daglish, WA	100.00	''	''
Glennrae Pty Ltd, "Nelson Family A/c", PO Box 232, Kallangur, Qld	104.00	''	28/04/00
Glennrae Pty Ltd, "Nelson Family A/c", PO Box 232, Kallangur, Qld	130.00	''	27/10/00
Helen Glezer & Leon Glezer, 35 Swinburne Ave, Hawthorn	150.00	''	''
Globell Glen Pty Limited, 21 Moss St, West Ryde, NSW	252.35	''	28/04/00
Globell Glen Pty Limited, 21 Moss St, West Ryde, NSW	418.50	''	27/10/00
Glorill Pty Ltd, "Superannuation Fund A/c", 8 Macarthur Street, Mackay South, Qld	100.00	''	''

Mr Laurence Graham Glossop, "Mark Darren Glossop A/c", 19 Calcite Place, Forrestfield, WA	100.00	"	"
Mr Paul James Goddon, 28 Balston Street, St Kilda East	120.70	"	28/04/00
Deanne Godfrey, 1 Ellen Street, Subiaco, WA	232.00	"	27/10/00
Robert Cleveland Godfrey, "Est Phylis Ester Godfrey A/c", 78 Sutherland Street, Paddington, NSW	200.00	"	"
Belita Margaret Godinho & Anthony Joseph Godinho, 5 Camfield Place, Beechboro, WA	100.00	"	"
David Clinton Godwin, 5 Lae Drive, Runaway Bay, Qld	100.00	"	"
Godwulf Pty Ltd, "CT Tan Family Account", 3 Bindaring Parade, Claremont, WA	160.00	"	"
Mr David Andrew Goffman, "David Goffman A/c", Unit 22/70 Delfin Drive, MacGregor, Qld	470.00	"	"
Andy Goh, 4 Ithaca Court, Chadstone	120.00	"	"
Chor Cheng Goh, 6 Anglers Esplanade, Runaway Bay, Qld	100.00	"	"
Chor Lim Goh, 222 Station Road, Sunnybank, Qld	140.00	"	"
Mrs Lian Goh, 10 Page Crescent, Panorama, SA	870.00	"	"
Mr Jeremy Louis Goldberg, 41 Wellington St, Bondi, NSW	100.00	"	"
Andrew Goldsmith, "Eulah S Fund A/c", PO Box 44, Crows Nest, NSW	208.00	"	28/04/00
Andrew Goldsmith, "Eulah S Fund A/c", PO Box 44, Crows Nest, NSW	260.00	"	27/10/00
Jennifer Gomez, 1 Burke Court, Cobram	100.00	"	"
Carlos Goncalves & Vanessa Andreia Goncalves & Elizabeth Samanta Goncalves, 63 Blenheim Street, Croydon Park, NSW	120.70	"	28/04/00
Ms Maria A Goncalves, PO Box 3244, East Doncaster	192.95	"	"
Miss Michele Gontier, 12/30 Drummoyne Avenue, Drummoyne, NSW	108.00	"	27/10/00
Mrs Milagro Gonzalez, 2 Marsh Street, Wakeley, NSW	100.00	"	27/10/00
Francisca Gonzalo-Puebla, 22 Brereton St, Garran, ACT	169.60	"	28/04/00
Francisca Gonzalo-Puebla, 22 Brereton St, Garran, ACT	212.00	"	27/10/00
Mrs Alma Mabel Gooch, C/- Allmand Partners, Level 7, 459 Collins Street, Melbourne	100.00	"	"
David Richard Gooch, 5 Whitney Crescent, Mt Claremont, WA	100.00	"	"
David Gooch, 5 Whitney Crescent, Mt Claremont, WA	140.00	"	"
Kim Goodridge & Ingrid Goodridge, "K & I Goodridge Super A/c", 80 Thomas Street, Nedlands, WA	120.70	"	28/04/00
Kim Goodridge & Ingrid Goodridge, "K & I Goodridge Super A/c", 80 Thomas Street, Nedlands, WA	200.00	"	27/10/00
Paula Ann Goodwin, 46 Graylands Rd, Claremont, WA	100.00	"	"
Charles Henry Scott Goodwin, 50 Cluny Road, Plimmerton, Wellington, New Zealand	112.00	"	28/04/00
Charles Henry Scott Goodwin, 50 Cluny Road, Plimmerton, Wellington, New Zealand	140.00	"	27/10/00
Mr Charles Henry Scott Goodwin & Ms Rochelle Mary Handley, 50 Cluny Road, Plimmerton, Wellington, New Zealand	217.20	"	28/04/00

Mr Charles Henry Scott Goodwin & Ms Rochelle Mary Handley, 50 Cluny Road, Plimmerton, Wellington, New Zealand	360.00	”	27/10/00
Mr Frank Goon, C/- Burdett Buckeridge Young Ltd, GPO Box 4663, Sydney, NSW	1,000.00	”	”
Merridy Susan Gordon, 5 Hood Terrace, The Gardens, NT	110.00	”	”
Hali Gordon, Suite 401, 73 Flinders Lane, Melbourne	200.00	”	”
Lisa Michelle Gorey, 15 McDonald Street, Beaumaris	110.00	”	”
Peter Richard Gorman & Jane Katherine Gorman, PO Box 197, Scone, NSW	100.00	”	”
John Michael Gorman & Elaine Hazel Gorman, 20 Pearse Road, Aireys Inlet	100.00	”	”
Mr Peter Gorog, 3 Bernie Street, Toorak	100.00	”	”
Roslyn Louise Gorrie, 309 Shakespeare St, Mackay, Qld	200.00	”	”
Garrick George Gorrie, 309 Shakespeare St Mackay, Qld	120.70	”	28/04/00
Garrick George Gorrie, 309 Shakespeare St, Mackay, Qld	200.00	”	27/10/00
G. G. Gorrie, “Gorrie Dis A/C”, 309 Shakespeare Street, Mackay, Qld	120.70	”	28/04/00
G. G. Gorrie, “Gorrie Dis A/C”, 309 Shakespeare Street, Mackay, Qld	200.00	”	27/10/00
Leo Gothelf, “Camrik Pty Ltd Super Fund”, 48 Wallaroy Rd, Woollahra, NSW	280.00	”	”
Leo Gothelf & Nina Gothelf, 48 Wallaroy Road, Woollahra, NSW	100.00	”	”
Margarkt Gottlieb & Ian Goodenough, 19 Bay Road, Waverton, NSW	100.00	”	”
Valerie Joan Gotts, 285 Dore Road, Nar Nar Goon	120.00	”	”
Bradley Goudie, 2 Alexandra Court, Melton	110.00	”	”
John Gough, 2/27 Radnor Street, Indooroopilly, Qld	140.00	”	”
John Stewart Gough, C/- Ernst/Young, GPO Box 67B, Melbourne	960.00	”	”
Raoul Gough, 2/27 Radnor Street, Indooroopilly, Qld	100.00	”	”
Derrick Gould & Sheila Gould, 18 Stack St, Fremantle, WA	100.00	”	”
Judith Anne Gould, 3e Elegance Court, Hillgrove Village, Discovery Bay, Lantau Island	100.00	”	”
Walter Gowans, 2 Vermouth Place, Carseldine, Qld	250.00	”	”
GP Australia Pty Ltd, “GP Australia S/Fund A/c”, 210 Riversdale Rd, Hawthorn	110.00	”	”
Kirsten Grace, 7/2A Milner Cres, Wollstonecraft NSW	132.85	”	28/04/00
Kirsten Grace, 7/2A Milner Cres, Wollstonecraft, NSW	220.00	”	27/10/00
Patricia Anne Gradwell, “Alannah Beryl Gradwell A/c”, Henderson Lane, Lennox Head, NSW	120.00	”	28/04/00
Daniel James Gradwel, Henderson Lane, Lennox Head, NSW	120.00	”	”
George Graham, 6/1 Grant Street, East Malvern, NSW	100.00	”	27/10/00
Barbara Elizabeth Graham, 13 Woids Avenue, Hurstville, NSW	100.00	”	”
David Graham, PO Box 12332, Abeckett Street, Melbourne	169.60	”	28/04/00
Mr Robert Hamilton Graham, 31 Peninsular Road, Maylands, WA	150.00	”	27/10/00
Graham Bailey Pty Ltd, “Fortescue Fund A/c”, 20 Keane Street, Peppermint Grove, WA	1,000.00	”	”
Grand Indulgence Pty Ltd, “Spinazzola Family Trust A/c”, 12 Annan Court, Greenvale	120.00	”	”

Granite Enterprises Pty Ltd, "Granite Ent P/L Super A/c", PO Box 59, Burswood, WA	100.00	"	"
Mr Patrick Grant & Mrs Jacqueline Grant, "Grant Super Fund A/c", PO Box 7001, Karingal	360.00	"	"
Ms Stephanie Lucille Grant, PO Box 30, Balfour, New Zealand	156.67	"	28/04/00
Ms Stephanie Lucille Grant, PO Box 30, Balfour, New Zealand	212.00	"	27/10/00
Georgina Grantham, 21 St Bernards Drive, Keilor East	100.00	"	"
Jessica Emma Ann Grassick, 111 Eaton Road, West Pennant Hills, NSW	100.00	"	"
Grateling Pty Ltd Super Fund, 209 Birrell St, Bondi, NSW	200.00	"	"
Ms Kaye Frances Gratton, 57 Lake View Drive, Edgewater, WA	100.00	"	"
Roderick Dhu Gray, 115 Blues Point Road, North Sydney, NSW	305.60	"	28/04/00
Elizabeth Patricia Gray, 26 Moynihan Street, Ascot, Qld	240.00	"	27/10/00
Isabella Gray, 32 Williason Road, Carlton, NSW	120.70	"	28/04/00
Isabella Gray, 32 Williason Road, Carlton, NSW	200.00	"	27/10/00
Henri Gray, 32 Willison Road, Carlton, NSW	120.70	"	28/04/00
Henri Gray, 32 Willison Road, Carlton, NSW	200.00	"	27/10/00
Mario Gerald Graziano & Patricia Graziano, 32 Norfolk Avenue, Collaroy, NSW	208.00	"	"
Greater Kailash Pty Ltd, 144 Kooyong Road, Toorak	100.00	"	"
Dorothy Green & Georgina Green, 16/14 Wilga Street, Bondi, NSW	100.00	"	"
Andrew Green, 77 Wellington Street, Richmond	192.00	"	28/04/00
Janice Holt Green, 83 Elimatta Rd, Mona Vale, NSW	160.00	"	"
Janice Holt Green, 83 Elimatta Rd, Mona Vale, NSW	200.00	"	27/10/00
Mr John Green, Unit 4, 407 Swanston Street, Melbourne	225.00	"	"
Mr Simon Geoffrey Green, 21 Beacon Vista, Port Melbourne	1,000.00	"	"
Dorothy Green & Leslie Green, "Georgina Rose Green A/C", 238 Military Road, Dover Heights, NSW	100.00	"	"
Kristie Erica Greening & Jacqueline Lee Greening & Cara Maree Greening, RMB 3428, Dogtrap Road, Somersby, NSW	132.85	"	28/04/00
Kristie Erica Greening & Jacqueline Lee Greening & Cara Maree Greening, RMB 3428, Dogtrap Road, Somersby, NSW	220.00	"	27/10/00
David Eric Greening & Evelyn Ruth Greening, RMB 3428, Dogtrap Road, Somersby, NSW	120.70	"	28/04/00
David Eric Greening & Evelyn Ruth Greening, RMB 3428, Dogtrap Road, Somersby, NSW	200.00	"	27/10/00
Ellen Kay Greenleaf, PO Box 748, Potts Point, NSW	100.00	"	"
Greenmay Pty Ltd, "Clt Super A/c", 17 Lawborough Avenue, Parkdale	100.00	"	"
David Geoffrey Greenwood & Margery Jane Greenwood, 9 Duncan Street, Mackay, Qld	126.13	"	28/04/00
David Geoffrey Greenwood & Margery Jane Greenwood, 9 Duncan Street, Mackay, Qld	208.60	"	27/10/00
Eileen Mary Greer, 9 Wilson Street, Surrey Hills	160.00	"	28/04/00
Eileen Mary Greer, 9 Wilson Street, Surrey Hills	200.00	"	27/10/00
Greg Hunt Pty Ltd, 21a Seaview Road, Tennyson, SA	250.00	"	"

Mr Murray S. Gregg, 21 Kensington Gardens, Kingston Upon Thames, KT12JU United Kingdom	110.00	''	''
Mr Murray S. Gregg, 21 Kensington Gardens, Kingston Upon Thames, KT12JU United Kingdom	121.25	''	''
Mrs Maria Beatriz Gregorios, PO Box 232, Surrey Hills	596.00	''	28/04/00
Mrs Maria Beatriz Gregorios, PO Box 232, Surrey Hills Estate Bernadette Paula Greig, 55 Maraket Avenue, Blaxland, NSW	660.00	''	27/10/00
Mr Timothy Greville, 30 Bulwarra Road, Pyrmont, NSW	100.00	''	''
Edward Grewar, 105 Murton Avenue, Holland Park, Qld	108.60	''	28/04/00
Phyllis H. Grey, 15 Trafalgar Road, Camberwell	120.00	''	27/10/00
Phyllis H. Grey, 15 Trafalgar Road, Camberwell	160.00	''	28/04/00
Phyllis H. Grey, 15 Trafalgar Road, Camberwell	200.00	''	27/10/00
Helen Maree Griffin, 134 Irby Boulevarde, Sisters Beach, Tas.	100.00	''	''
Mr Gary Griffin, 49 Wills Street, Largs Bay, SA	100.00	''	''
Mrs Debbie Griffin, 128 Normandy Drive, Greenvale	100.00	''	''
Mrs Kelvin James Griffin, 128 Normandy Drive, Greenvale	100.00	''	''
Mr Warren John Griffin, "Status Management S/F A/c", 9 Carlton Crescent, Kogarah Bay, NSW	100.00	''	''
Matthew Griffiths, PO Box 409, Prahran	120.00	''	''
Brittney Griffiths, 2 Yaralla Street, Newtown, NSW	200.00	''	''
Ella Mary Griffiths, 38 Malga Ave, Roseville Chase, NSW	200.00	''	''
Mr Timothy John Griffiths, 6 Wentworth Strreet, Dover Heights, NSW	100.00	''	''
Julie A. Grills, PO Box 186, Tamworth, NSW	100.00	''	''
Michelle Elizabeth Grogan, 26 Delphinium Place, Kellyville, NSW	100.00	''	''
Mr Jeremy Richard Gronow, 5 Shoobra Road, Elsternwick	100.00	''	''
Cameron Jacob Grove, Lot 111, Wattleup Rd, Wattleup, WA	100.00	''	''
Nicholas William Grove, Lot 11, Wattleup Road, Wattleup, WA	100.00	''	''
Grovemoss Pty Ltd & "Greenwell Super Fund A/c", 18 Shearn Crescent, Doubleview, WA	100.00	''	''
Kenneth William Groves, 39/71 Victoria St, Potts Point, NSW	108.00	''	''
Mrs Elizabeth Grozdanovski, 22 Second Ave, Eastwood, NSW	157.05	''	28/04/00
Mrs Elizabeth Grozdanovski, 22 Second Ave, Eastwood, NSW	260.00	''	27/10/00
Mr Walter Marcel Grzentic, 19 Donaldson Street, Ivanhoe Est Wiktorja Grzyb & Est Antoni Grzyb, 51 Manningford Street, Elizabeth South, SA	100.00	''	''
Mr Mingu Gu, 36 Catalina Street, Heidelberg West	256.00	''	28/04/00
Dr Yong Quan Gu & Ms Hui Liu, Vascular Surgery Laboratory Austin Hospital, Heidelberg	108.00	''	27/10/00
Ms Zuo Ping Guan, Unit 29b-Block B, Yuanling-Yuanzhou Garden, Hong Li Road, Shenzhen	100.00	''	''
Helen Gucllel, 101 Dooring St, Dickson, ACT	1,500.00	''	''
Helen Gucllel, 101 Dooring St, Dickson, ACT	120.70	''	28/04/00
John Gudgeon, 113 Wattle St, O'connor, ACT	200.00	''	27/10/00
Ms Gilba Guerra, PO Box 484, Rosanna	100.00	''	''
Zhizhen Gui, Dept of Economics, University Of New England, Armidale, NSW	120.70	''	28/04/00
Frederick Albert Gundry, 29 Comara Terrace, Crescent Head, NSW	560.00	''	27/10/00
Robin J. Gunn, 18 Fraser Crescent, Wantirna South	100.00	''	''
Jareth Rhys Gunner, 103 Mcpherson, Essendon	100.00	''	''
	192.00	''	28/04/00

Gurawon Investments Pty Ltd, "Chan Super Fund A/C", 63 Clanville Rd, Roseville, NSW	2,000.00	"	27/10/00
Mr Robert James Guthrie, 14 South Street, Fremantle, WA	150.00	"	"
Mrs Margaret Anne Guthrie, 3A Rain Place, Bayswater, WA	160.00	"	"
Peter Heins Gutwein, 30 Sutherland Road, Armadale	315.00	"	"
Julian Guy, "Zodiac Tooling S/F No 5 A/c", 21 Scanlan Street, Berwick	120.00	"	28/04/00
Julian Guy, "Zodiac Tooling S/F No 5 A/c", 21 Scanlan Street, Berwick	150.00	"	27/10/00
Mr Lee W. Gwilliam, 23 Division Street, Coogee, NSW	108.00	"	"
Kenneth Tai K. H., 18 Mcculloch Rise, Bull Creek, WA	120.00	"	"
An Ha, 11 Empire St, Footscray	100.00	"	"
Quoc Huan Ha, 158 Chapel Road, Banktown, NSW	100.00	"	"
Graham Habgood, RMB 2324, Main Road, Fullerton Cove, NSW	280.00	"	"
Mr Joshua Habib, 24 Brennan Street, Yagoona NSW	112.00	"	28/04/00
Mr Joshua Habib, 24 Brennan Street, Yagoona, NSW	140.00	"	27/10/00
Mr Ashley Wayne Hack, PO Box 3031, Rundle Mall, SA	140.00	"	"
Susanne Hacker, 'Aschau', Dalgety Road, Jindabyne, NSW	160.00	"	"
Daniel Hahling, PO Box 786, South Perth, WA	200.00	"	"
Christopher C. Haigh, 17 Lily Street, Bentleigh	240.00	"	28/04/00
Halbiji Pty Ltd, Vitality Health Food, Greenslopes Shop Mall, Greenslopes, Qld	100.00	"	27/10/00
Mr Robert Geoffrey Hale, 249 Extons Road, Kinglake	100.00	"	"
Mr Trevor Hales, PO Box 367, Clifton Hill	144.00	"	28/04/00
Mr Trevor Hales, PO Box 367, Clifton Hill	180.00	"	27/10/00
Mr Trevor Hales, PO Box 367, Clifton Hill	120.00	"	"
Mr Ivan Halim, 31 Congewoi Rd, Mosman, NSW	362.15	"	28/04/00
Halith Pty Ltd, 385 Sydney Rd, Coburg	200.00	"	"
Halith Pty Ltd, 385 Sydney Rd, Coburg	250.00	"	27/10/00
Michael George Hall & Pamela Joyce Hall, 15 Suffolk Crescent, Mount Martha	212.00	"	"
Terrie Hall, 4/24 Castlebar Street, Kangaroo Point, Qld	100.00	"	"
Mr Brian Hall, 58 Murdoch Street, Cremorne, NSW	220.00	"	"
Glenn Cornel Hall, PO Box 1442, Parramatta, NSW	100.00	"	"
Hallam Street Nominees Pty Ltd, Level 2, 111 Collins Street, Melbourne	160.00	"	28/04/00
Hallam Street Nominees Pty Ltd, Level 2, 111 Collins Street, Melbourne	200.00	"	27/10/00
Ian Stuart Halliday, PO Box 394, Frankston	169.20	"	28/04/00
Ian Stuart Halliday, PO Box 394, Frankston	280.00	"	27/10/00
Lindy Diane Halliday, 96 Wallandra Rd, Mudgeeraba, Qld	120.00	"	28/04/00
Lindy Diane Halliday, 96 Wallandra Rd, Mudgeeraba, Qld	150.00	"	27/10/00
Mr David William Halliday, 13 St Andrew Street, Balmain, NSW	181.30	"	28/04/00
Lisa Jane Halloran, 90 Charles Street, Erskineville, NSW	100.00	"	27/10/00
Halpron Pty Ltd, PO Box 965, Bankstown, NSW	240.00	"	"
Ronald Bruce Halstead, PO Box 4528, Darwin, NT	200.00	"	"
Ms Mary Halvatis, 10 Leatherwood Crescent, Meadow Heights	120.70	"	28/04/00
Ms Faye P. Hambour, "FPH S Fund A/c", PO Box 888, Burnside, SA	520.00	"	27/10/00

Ms Fay Hambour "FPH Super Fund A/c", PO Box 888, Burnside, SA	400.00	"	"
Mrs Anne Louise Hamersley, 22 Davies Road, Dalkeith, WA	120.00	"	"
Robert Macaulay Sommerville Hamilton, "Marymac Super Fund A/C", The Head Road, Ms 488, Carneys Creek, Qld	100.00	"	"
Luke Hamilton, 40 Kunyung Road, Mt Eliza	120.00	"	"
Peter John Hamilton & Jeanette Lee Hamilton, 36 Amelia Close, Beaconsfield	220.00	"	"
Wayne O Hamilton, 122 Wharf Street, Cannington, WA	112.00	"	28/04/00
Wayne O. Hamilton, 122 Wharf Street, Cannington, WA	140.00	"	27/10/00
Mark John Hamlyn, 84 Hawthorn Road, Chatswood, NSW	100.00	"	"
Sandra Hammill, 9 Eveli Close, Narre Warren Nth	100.00	"	"
Tony Hance, 53 North Road, Brighton	100.00	"	"
Mr Francis Thomas Hancock & Mrs Helen Elizabeth Hancock, "F & H Hancock A/C", C/- Invia Custodian Pty Ltd, GPO Box 4595 Ss, Melbourne	104.00	"	28/04/00
Ian Gilbert Handcock, 28 Allen Street, East Fremantle, WA	100.00	"	27/10/00
Margaret Mary Handcock, 28 Allen St, East Fremantle, WA	100.00	"	"
Rochelle Maree Handley, C/- Marvel Loch Gene, Marvel Loch, WA	112.00	"	28/04/00
Rochelle Maree Handley, C/- Marvel Loch Gene, Marvel Loch, WA	140.00	"	27/10/00
John Hankins, C/- PO Box 886, Perth, WA	120.00	"	28/04/00
John Hankins, C/- PO Box 886, Perth, WA	150.00	"	27/10/00
Amir Hanna, 17 Renou Road, Wantirna	100.00	"	"
Melissa Jayne Hannam, 4 Navel Close, Armadale, WA	100.00	"	"
Ross Cameron Hannant, 13 Princess Court, Kingaroy, Qld	182.40	"	28/04/00
Ross Cameron Hannant, 13 Princess Court, Kingaroy, Qld	228.00	"	27/10/00
Edward P. Hannon, 28 Fairfax Rd, Bellevue Hill, NSW	100.00	"	"
Carl Rupert Hansen, Applegrove, Grove, Tas.	180.00	"	"
Mark Rupert Hansen, Aplegrove, Grove, Tas.	100.00	"	"
Coral May Hansen & Loren Hansen, 54 Keona Road, McDowall, Qld	200.00	"	"
Mark Hanson, 855 Pacific Highway, Pymble, NSW	120.70	"	28/04/00
Hanson Consulting Group Pty Ltd, 77 Pigdon Street, Carlton North	240.00	"	27/10/00
Xu Haorui, Unit 4/18 Macquarie Road, Auburn, NSW	100.00	"	"
Maree C. Harcourt, 19 High Street, Trentham	282.40	"	28/04/00
Maree C. Harcourt, 19 High Street, Trentham	353.00	"	27/10/00
Mr Bill Hardge, 125/416a St Kilda Road, Melbourne	141.50	"	"
Peter Nelson Hardiman, 1/123 Sydney Rd, Fairlight, NSW	100.00	"	"
Mr Peter W Harding, 16 Roslyn Street, Burwood	265.00	"	"
Graham Hardy, 24 Kneen St, North Fitzroy	284.00	"	"
Mr Fazlun Mohamed Haris & Mrs Fathima Sabrina Haris, "Haris Super Fund Account", 109 Crozier Circuit, Kambah, ACT	100.00	"	"
Bernadette Harkin, 20 Ernest Street, Windsor, Qld	140.00	"	"
Angela Harlington, PO Box 144, Richmond	100.00	"	"
Harmony System Consultants Pty Ltd, "Superfund No 99 978 805 A/c", 137 Nelson Street, Annandale, NSW	222.64	"	28/04/00

Harmony System Consultants Pty Ltd, "Superfund No 99 978 805 A/c", 137 Nelson Street, Annandale, NSW	278.30	"	27/10/00
Ashwani Kumar Harnal, "Harnal Fmly Supr Fund A/c", 1 The Grange, Yallambie	108.00	"	"
Mr Robert Harney, 34B Pacific Boulevard, Beaumaris	124.60	"	"
Sian Harper, 1 Wairoonga Crt, Glen Iris	100.00	"	"
Don Harper, 3/24A Belmore Street, Ryde, NSW	200.00	"	"
W Peter Harper, GPO Box 4309, Sydney, NSW	100.00	"	"
David John Harrington, 58b Lower Fort Street, Millers Point, NSW	176.00	"	28/04/00
David John Harrington, 58B Lower Fort Street, Millers Point, NSW	220.00	"	27/10/00
Mark Alan Harris, 10 Wannan Court, Melton South	110.00	"	"
Valma Harris, 24 Mona Vale Road, Pymble, NSW	100.00	"	"
Bradley Harris, 11 Chapmans Road, Castlemaine	248.00	"	"
Reginald Harris, 252 Belgrave Esplanade, Sylvania Waters, NSW	100.00	"	"
Samuel John Harris, 47 Collingrove Ave, Broadview, SA	100.00	"	"
Mr Michael Paul Harris, 5 Hoylake Crescent, West Lakes SA	160.00	"	28/04/00
Mr Michael Paul Harris, 5 Hoylake Crescent, West Lakes, SA	200.00	"	27/10/00
Matthew James Harris, 49 Victoria Rd, N. Malvern	100.00	"	"
David I. Harris, 4/242 Exhibition Street, Melbourne	345.60	"	28/04/00
David I. Harris, 4/242 Exhibition Street, Melbourne	432.00	"	27/10/00
Mr Maxwell Wansbrough Harris, 12 Grandview Road, Glen Iris	176.00	"	28/04/00
Mr Maxwell Wansbrough Harris, 12 Grandview Road, Glen Iris	220.00	"	27/10/00
Mr Michael Paul Harris & Mr Paul Paterson Harris, "Michael Harris S/Fund A/C", 263 Grange Rd, Findon, SA	301.55	"	28/04/00
Mr Michael Paul Harris & Mr Paul Paterson Harris, "Michael Harris S/Fund A/C", 263 Grange Rd, Findon, SA	500.00	"	27/10/00
Andrew John Harrison, 28 Chapel Street, Glen Waverley	100.00	"	"
Stephen Harrison, 19 Union Street, Richmond	152.00	"	28/04/00
Stephen Harrison, 19 Union Street, Richmond	190.00	"	27/10/00
Mr Barrie John Harrop, 19 Park Terrace, Gilberton, SA	181.30	"	28/04/00
Sam David Hart, 9 Rosedale Ave, Fairlight, NSW	178.00	"	27/10/00
Mr Dormer C. Hart Mrs Lesley Hart, 4 Wallace Street, Congupna	100.00	"	"
Riccardo Wilfred Hart & Vanessa Bernadine Gomez, 56 Boyd St, Dandenong North	200.00	"	"
Mr Paul Desmond Harte & Ms Julie Maree Hanley, "Harte Foundation S/F A/C", 84 Mitford Street, Elwood	108.00	"	"
Liam T. Harte, 21 Wycombe Avenue, Brighton-Le-Sands, NSW	100.00	"	"
Morgan Hartley & Lavinia Hartley, 30 Rutherford Street, South Hedland, WA	100.00	"	"
Mr Andrew John Hartwig & Mrs Lia Hartwig, Lakefield, PMB 29, Cairns Mail Centre, Qld	100.00	"	"
Harvco Nominees Pty Ltd, PO Box 7625, Cloisters Square, WA	325.80	"	28/04/00
Stephen Clive Harvey, 163 Sycamore St, Caulfield South	144.00	"	"

Stephen Clive Harvey, 163 Sycamore St, Caulfield South	180.00	''	27/10/00
Ms Suzanne Marie Harvey, "E&S Harvey&J O'Sullivan A/c", 109 Cabernet Crescent, Bundoora	100.00	''	''
Anthony Hasham & Mira Hasham, 4/15 Clyde Street, Croydon Park, NSW	100.00	''	''
Seyed Reza Hashemi-Nezhad, 7 Larool Cres, Thornleigh, NSW	232.00	''	28/04/00
Mrs Beverley Haswell, 55 Churchill Street, Fairfield, NSW	240.00	''	27/10/00
Ms Maryella Hatfield, 3A/13 Fletcher Street, Bondi, NSW	100.00	''	''
Miss Alissa Anne Hattersley, PO Box 1, Lindfield, NSW	100.00	''	''
Mr Minh Ca Hau, 30 Killara Avenue, Riverwood, NSW	200.00	''	''
Gabriel Hau, 29 Roenfeldt Dr, Tanunda, SA	120.70	''	28/04/00
Gabriel Hau, 29 Roenfeldt Dr, Tanunda, SA	200.00	''	27/10/00
Travis Jay Haupstein & Patricia Leonie Haupstein, "Jayton Zac Haupstein A/c", 17 Cooraminta St, Brunswick	110.00	''	''
Ian Phillip Hawes, 205 Anthony Place, Sawyers Valley, WA	100.00	''	''
Mr Peter Hawkins, 58 Tilson Drive, Vermont	127.90	''	28/04/00
Mr Peter Hawkins, 58 Tilson Drive, Vermont	212.00	''	27/10/00
Andrew Hawkins, 5/132 Albert Road, South Melbourne	240.00	''	''
Peter John Hawton, 80 Southernview Drive, Albury, NSW	100.00	''	''
Jason Hay, 11 College Av, Bellevue Heights, SA	100.00	''	''
Robert Jeffrey Haybrow, "Superannuation Fund A/c", Level 2, 65 Berry Street, North Sydney, NSW	217.20	''	28/04/00
Justin Peter Hayden, 26 Allambie Drive, Goonellabah, NSW	100.00	''	27/10/00
Cecelia Anne Haydon, PO Box 30, Valentine, NSW	160.00	''	28/04/00
Mr Philip Hayes, 4/7 Gurner Street, St Kilda	100.00	''	27/10/00
Valerie Elaine Hayes, 8 Bass Court, Shepparton	160.00	''	''
Karen Leanne Hayes, 8 Bass Court, Shepparton	110.00	''	''
David George Hayes, "Mitchell Grant Hayes A/c", 8 Bass Court, Shepparton	110.00	''	''
David George Hayes, "Connor James Hayes A/c", 8 Bass Court, Shepparton	110.00	''	''
David George Hayes, 8 Bass Court, Shepparton	160.00	''	''
Grant Cameron Hayes, 8 Bass Court, Shepparton	110.00	''	''
Hayles Pty Ltd, "Auburna A/C", 1 Barrett St, Wembley, WA	168.00	''	28/04/00
Ronald Brett Haywood, 34 Faversham St, Beckenham, WA	160.00	''	27/10/00
Mr Matthew Hazard, PO Box 95, Waterloo, NSW	366.00	''	''
Tony Hazard, 6 Jilpangi Cresnet, Ashmore, Qld	169.20	''	28/04/00
Hazel Howard Start Pty Ltd, PO Box 555, Fortitude Valley, Qld	160.00	''	27/10/00
Hazell Corp Pty Ltd, "The TJ Hazell No1 A/c", 8 Redgrove Avenue, Birkdale, Qld	100.00	''	''
Dave Hazeltine, PO Box 445, Civic Square, ACT	322.00	''	''
Mr Trevor Romanis Hazlewood, 15 Astor Terrace, Spring Hill, Qld	100.00	''	''
Mukesh Hazrat & Alka Hazrat, 34 Fooks St, Carindale, Qld	140.00	''	''
HCG Holdings Pty Ltd, 77 Pigdon Street, Carlton North	240.00	''	''
HCG Investments Pty Ltd, 77 Pigdon Street, Carlton North	240.00	''	''
Lucy Yu Mei He, PO Box 860, Bankstown, NSW	315.00	''	''
Fang Xiao He & Chun Xin He, 6/49 Sherwood Street, Revesby, NSW	100.00	''	''

Mr James Walter Head & Mrs Nance Elizabeth Head, 11 Spring Street, Mt Keira, NSW	330.00	''	''
Mr Travis Leigh Heal, Unit 8, 516 Moreland Rd, Brunswick Dorothy Lynne Healey & John Reginald Healey, 8 Katrina Avenue, Mona Vale, NSW	150.00	''	''
Patrick Raymond Healey, 1/40 Chaucer Street, St Kilda	120.70	''	28/04/00
Mr Alex Healey, "Healey Superfund A/c", C/- Milton Toal, 19 Village Avenue, Doncaster	102.00	''	27/10/00
Robert Healy, 26 North Street, Frewville, SA	208.10	''	28/04/00
Roger Kenneth Healy, 23 Damon Road, Lutwyche, Qld	200.00	''	27/10/00
James M. Healy, 106 Barrack Street, Merredin, WA	246.40	''	28/04/00
James M. Healy, 106 Barrack Street, Merredin, WA	240.00	''	''
Michael James Heap, PO Box 1820, Toowong, Qld	300.00	''	27/10/00
Michael James Heap, PO Box 1820, Toowong, Qld	401.60	''	28/04/00
Michael James Heap, PO Box 1820, Toowong, Qld	352.00	''	27/10/00
Mary Anne Heap, PO Box 1820, Toowong, Qld	136.00	''	28/04/00
Mary Anne Heap, PO Box 1820, Toowong, Qld	170.00	''	27/10/00
Donna Heard, 12 Napier Street, Carina, Qld	120.00	''	''
Patrick John Hearn, 22 Frances Street, Lindfield, NSW	180.00	''	''
Paolina Joan Hearn, 21a Seaview Road, Tennyson, SA	1,145.60	''	28/04/00
Samuel Heath, 19 Kellaway Street, Doonside, NSW	120.00	''	27/10/00
David John Heath & Ann Mercia Heath, 11 Kwinana Street, South Hedland, WA	100.00	''	''
David John Heath, 11 Kwinana Street, South Hedland, WA	200.00	''	''
Nicholas Heath, 25 Glenrosa Road, Red Hill, Qld	100.00	''	''
Nicholas Heath, Lot 1, Clear Mountain Road, Clear Mountain, Qld	100.00	''	''
Nicholas Heath & Lee-Anne Elms, Lot 1 Clear Mountain Rd, Clear Mountain, Qld	100.00	''	''
Nicholas Heath & Murray Heath, Lot 1 Clear Mountain Rd, Clear Mountain, Qld	100.00	''	''
Nicholas Heath & Lee-Anne Elms & Murray Heath, Lot 1, Clear Mountain Rd, Clear Mountain, Qld	100.00	''	''
Betty Heath, Lot 1, Clear Mountain Rd, Clear Mountain, Qld	100.00	''	''
Betty Heath & Nicholas Heath, Lot 1, Clear Mountain Rd, Clear Mountain, Qld	100.00	''	''
Betty Heath & Murray Heath, Lot 1, Clear Mountain Rd, Clear Mountain, Qld	100.00	''	''
Betty Heath & Lee-Anne Elms, Lot 1, Clear Mountain Rd, Clear Mountain, Qld	100.00	''	''
Nicholas Heath & Betty Heath & Murray Heath, Lot 1, Clear Mountain Rd, Clear Mountain, Qld	100.00	''	''
Nicholas Heath & Betty Heath & Lee-Anne Elms, Lot 1, Clear Mountain Rd, Clear Mountain, Qld	100.00	''	''
Mr David John Heath, 11 Kwinana Street, South Hedland, WA	1,500.00	''	''
Heath Fielding Australia Superannuation Fund Pty Ltd, "RJ Whybrow Super Fund", Lvl 2/65 Berry Street, North Sydney, NSW	128.00	''	28/04/00
Beverly Heaton, 4 Kamiri Street, Seaforth, NSW	315.00	''	27/10/00
Neville Francis Hedge, 33/125 Park Road, Dundas, NSW	100.00	''	''
Michael J. Heeney, Locked Mail Bag 3806, Brisbane, Qld	176.00	''	28/04/00

Michael J. Heeney, Locked Mail Bag 3806, Brisbane, Qld	220.00	''	27/10/00
Sally Jane Heeps, 80 Croft Rd, Nar Nar Goon North	100.00	''	''
Mr David Linsey Hegarty, "Hegarty Investment A/C", C/- Rolins Chartered Accountants, GPO Box 640, Canberra, ACT	800.00	''	''
Mr David Linsey Hegarty, C/- Rolins Chartered Accountants, GPO Box 640 Canberra, ACT	700.00	''	''
Michael Deane Hehir, 16 Pohlman St, Latham, ACT	100.00	''	''
Barbara Elizabeth Hehir, 16 Pohlman Street, Latham, ACT	100.00	''	''
Heidi-Bee Investments Pty Ltd, "Colenbrander S Fund A/c", PO Box 530, Pymble, NSW	275.20	''	28/04/00
Heidi-Bee Investments Pty Ltd, "Colenbrander S Fund A/c", PO Box 530, Pymble, NSW	344.00	''	27/10/00
Janjan Margaret Heine, Faraway Farm, Aura Vale Road, Menzies Creek Heiton Pty Ltd,	362.15	''	28/04/00
"Page Family A/C", 14 Berry Street, East Melbourne Heiton Pty Ltd,	120.70	''	''
"Page Family A/C", 14 Berry Street, East Melbourne Hekeik Building Coy Pty Ltd,	200.00	''	27/10/00
"A & R Hekeik Super Fund", PO Box 955, Parramatta, NSW	100.00	''	''
Mr Colin James Helliwell & Mrs Marilyn Joan Helliwell, 10 Acer Glen, Duncraig, WA	240.00	''	28/04/00
Mr Neil William Hemington, Unit 5, 9-15 Fregon Road, Clayton	177.60	''	''
Mr Neil William Hemington, Unit 5, 9-15 Fregon Road, Clayton	222.00	''	27/10/00
Anna Henderson, 8 Scott Street, Essendon	157.05	''	28/04/00
David Ian Henderson, 8 Scott Street, Essendon	157.05	''	''
David Ian Henderson & Anna Henderson, 8 Scott Street, Essendon	157.05	''	''
Ms Sandra Henderson-Kelly, 57 Williamson Street, Holder, ACT	160.00	''	27/10/00
Sandra Marguerite Heng & Robert Heng, 11 Donavon Rise, Murdoch, WA	160.00	''	''
Mrs Sandra Marguerite Heng, 11 Donavon Rise, Murdoch, WA	100.00	''	''
Mark Clayton Henley & Jennifer Esther Henley, PO Box 177, Crafers, SA	100.00	''	''
Mrs Patricia Henneberry, "PLR&V Matsen A/c", 95 Pinjarra Road, Pinjarra, WA	100.00	''	''
Patricia June Hennerberry, 95 Pinjarra Road, Pinjarra, WA	100.00	''	''
Robert Newman Reid Henry, PO Box 1180, Woden, ACT	100.00	''	''
P. Henry, 61 Byron Place, Adelaide, SA	149.26	''	28/04/00
P. Henry, 61 Byron Place, Adelaide, SA	247.20	''	27/10/00
Mr Stephen Henschke, 11/79 Cambridge St, Carina, Qld	208.00	''	''
Henslowe Nominees Pty Ltd, 2/11 Ventnor Avenue, West Perth, WA	100.00	''	''
Mrs Joan Betsy Hepburn, PO Box 134, Queenstown, New Zealand	180.00	''	''
Shane Jonathon Herbert, PO Box 393, Hahndorf, SA	169.60	''	28/04/00
Shane Jonathon Herbert, PO Box 393, Hahndorf, SA	212.00	''	27/10/00

Mr Peter Herbert, 54 Bokhara Circuit, Kaleen, ACT	144.95	''	28/04/00
Olivia M Herdiman & Herdiman T. Pohan & Inggriati Selamat, 2/9 East Terrace, Adelaide, SA	100.00	''	27/10/00
Westley John Herring, 12 Walwa Street, Mitcham	100.00	''	''
Antonius Hertog & Doreen Hertog, 6 Amsterdam Circuit, Wagaman, NT	160.00	''	28/04/00
Colin Joseph Heskey, PO Box 6251, Tweed Heads, NSW	120.70	''	''
Colin Joseph Heskey, PO Box 6251, Tweed Heads, NSW	200.00	''	27/10/00
Lambertus John Hesterman, 10 Quandong Street, O'Connor, ACT	160.00	''	''
James Heyward & Sarah Heyward, PO Box 429, Richmond	192.00	''	28/04/00
Michael John Hibbert, 9 Randall Street, Agnes Banks, NSW	157.05	''	''
Michael John Hibbert, 9 Randall Street, Agnes Banks, NSW	260.00	''	27/10/00
Hibworth Pty Limited, "The Jane Kypreos Family A/c", 18 Carnarvon Road, Caulfield North	120.70	''	28/04/00
Jamie Hickey, 16 Abbott Street, Quirindi, NSW	120.00	''	27/10/00
David Hickman, 52 Baden Street, Greystanes, NSW	152.00	''	28/04/00
David Hickman, 52 Baden Street, Greystanes, NSW	190.00	''	27/10/00
Gary Higgan, PO Box 300, Ringwood BC	277.30	''	28/04/00
Debra A. Higginson, 1 Orange Street, Braybrook	151.00	''	''
Margaret Jean Higgs, "Julian Selby Higgs A/c", 24 Herring Street, Moorooka, Qld	120.00	''	27/10/00
Higgs & Associates "Super Fund A/c", 9 Baliol Street, College Park, SA	120.00	''	''
John Hildred, 617 Bourke Street, Surry Hills, NSW	112.00	''	28/04/00
John Hildred, 617 Bourke Street, Surry Hills, NSW	140.00	''	27/10/00
Debra Hill, 51 Millar Road, Tullamarine	100.00	''	''
Jacqueline Hill, 15 Queen Victoria St, Drummoyne, NSW	105.55	''	28/04/00
Jacqueline Hill, 15 Queen Victoria St, Drummoyne, NSW	175.00	''	27/10/00
Geoffrey Robert Hill, 15 Queen Victoria Street, Drummoyne, NSW	125.89	''	28/04/00
Geoffrey Robert Hill, 15 Queen Victoria Street, Drummoyne, NSW	208.30	''	27/10/00
Trevor Clive Hill, 51 Millar Road, Tullamarine	100.00	''	''
Susan Hill, 2 Lloyd Street, Kerang	120.00	''	''
Matthew Hill, PO Box 280, Foster, NSW	100.00	''	''
John Thomas Hill, "Christopher Kyle Hill A/c", 98 Makins Parade, Nobby Beach, Qld	100.00	''	''
Darren J. Hill, 72 Lloyd Avenue, Reservoir	151.00	''	28/04/00
Mr Michael Manners Hill, "M M Hill Super Fund A/C", C/- PO Box Y3046 East, St Georges Terrace, Perth, WA	600.00	''	27/10/00
Jonathan Hillman, 86 Cantrell Street, Yagoona, NSW	100.00	''	''
Joseph Hillmen, 16/35 Pennant Hills Road, North Parramatta, NSW	100.00	''	''
Peter Hills, 20 Kambrook Road, Caulfield	200.00	''	''
Luisse Hills, 2d Excelsior Avenue, Castle Hill, NSW	160.00	''	28/04/00
Luisse Hills, 2d Excelsior Avenue, Castle Hill, NSW	200.00	''	27/10/00
Alan John Hilton, 4 High Street, Edgecliff, NSW	100.00	''	''
Mr Kevin James Hinchcliff, Jl Siligitha Block F10, Nusa Dua Bali, Indonesia	100.00	''	''
Margaret J. Hindle, 4"B" Barron Road, Birkdale, Qld	100.00	''	''
Mark Alen Hing, 64 Lorraine Avenue, Arncliffe, NSW	378.00	''	''
Mr Roy Hirschowitz, 6/246 Chalmers St, Redfern, NSW	120.70	''	28/04/00

Mr Roy Hirschowitz, 6/246 Chalmers St, Redfern, NSW	200.00	''	27/10/00
Mr Alexander Hislop, 8 Browne Street, Subiaco, WA	151.00	''	28/04/00
Christine Hitchcock & Darryl Hitchcock, 19 Regency Court, Oatlands, NSW	212.00	''	27/10/00
Jason Scott Hitchison, 4/11 State Circle, Forrest, ACT	135.00	''	''
Cuong Quang Ho, 4 Hannam Street, Turrella, NSW	120.70	''	28/04/00
Mr Cam Thanh Ho, 243 Main Road East, St Albans	100.00	''	27/10/00
Mrs Po Ho, Unit 4/45 King Street, Doncaster East	100.00	''	''
Ms Alice Ho, 16 Covelee Circuit, Middle Cove, NSW	140.00	''	''
Stephen Ho, 4 Golf Road, Coburg North	100.00	''	''
Dan Thuy Hoang, 158 Chapel Road, Banktown, NSW	100.00	''	''
Jan Hoare, 2/191 McKean Street, Fitzroy North	180.00	''	''
Ms Barbara Jean Hobbs, 74 Hannah Street, Beecroft, NSW	140.00	''	''
David Hobbs, 16/242 Exhibition Street, Melbourne	100.00	''	''
David Hobbs, 13 Winton Street, Burwood	120.00	''	28/04/00
Mr John Ian Hobbs, 74 Hannah Street, Beecroft, NSW	240.00	''	27/10/00
Mr David W. Hobbs, PO Box 259, Burwood	328.00	''	28/04/00
Mr John Keith Hodge, "J&A Supertrust Ltd A/c", 6 Coles Road, Harbord, NSW	500.00	''	27/10/00
Mrs Mary Eugene Hodges, PO Box 179, Brunswick Heads, NSW	120.00	''	''
Jason Peter Hodges, 140 Bowman Street, Pyrmont, NSW	100.00	''	''
Mr Wayne Hodges, 12 Andamifi Court, Mildura	100.00	''	''
Lawrence Hoffman, "Hoffmann S Fund A/c", 19 Strickland Street, Rose Bay, NSW	376.00	''	''
Lawrence Hoffmann, 19 Strickland Street, Rose Bay, NSW	376.00	''	''
Lawrence Hoffmann, 19 Strickland Street, Rosebay, NSW	104.00	''	''
Adolf Hofmann, 57 Kelvinside Road, Noble Park	120.00	''	28/04/00
John Hogan, 80 Correys Avenue, Concord, NSW	100.00	''	27/10/00
Mr Phillip Hogan, 54 Harold Street, Bulleen	176.00	''	28/04/00
Ms Sally Hogg, 34 Union Street, Armadale	108.00	''	27/10/00
Peter George Hohaus, 15 Berrima Avenue, East Malvern	100.00	''	''
Julie Maxine Holah, 8 Alexandra Crescent, Surrey Hills	100.00	''	''
Michael Holbrook, "Michael Hilton Holbrook A/c", 29 Talbot Avenue, Balwyn	100.00	''	''
Dennis Holden, "Jessy&Charlie Canvert A/c", 409 Keilor Road, Niddrie	169.60	''	28/04/00
Dennis Holden, "Jessy & Charlie Canvert A/c", 409 Keilor Road, Niddrie	212.00	''	27/10/00
Felicity Holding, 343 Wattletree Road, East Malvern	104.00	''	28/04/00
Genevieve Malion Holland & Christopher Holland, 148 Simpson Street, Melbourne East	100.00	''	27/10/00
Genevieve Marion Holland & Declan James Holland, 148 Simpson St, Melbourne East	100.00	''	''
Genevieve Marion Holland & Mothy Holland, 148 Simpson Street, Melbourne East	100.00	''	''
Mr John Douglas Holland & Mrs Carolyn Joy Matthews, "Holly John Douglas Ave Holland", 38 Brentwood Road, Wattle Grove, WA	100.00	''	''
Hollar Pty Ltd, 50 Claremont Street, South Yarra	160.00	''	''
Stuart Holliday, 37 Bunarong Drive, Frankston	100.00	''	''
Mr Joe Hollowa, C/- Adventure (PNG) Pty Ltd, PO Box 6361, Boroko NCD, Papua New Guinea	189.55	''	28/04/00

Holloway Superannuation Nominees Pty Ltd, 5 Glenferrie Street, Caulfield North	242.01	''	''
Diana Margaret Holly, Fairview, Broomehill, WA	160.00	''	''
Karen Jill Holmes, 697 Spencer Street, West Melbourne	100.00	''	27/10/00
Mrs Beatrice Margaret Holmes, 31 Lilley Street, Ballarat	301.55	''	28/04/00
Mrs Beatrice Margaret Holmes, 31 Lilley Street, Ballarat	500.00	''	27/10/00
Stephen Holohan, "The Holohan Family Super A/c", 7 Simpson Place, Kingslangley, NSW	100.00	''	''
Torod Peter Holst, 13 Queens Avenue, Vaucluse, NSW	200.00	''	''
Jennifer Ann Holt, 8/9 Military Road, Watsons Bay, NSW	100.00	''	''
Mr John Holt, "Personal Super Fund A/c", 20 Cumberland Street, Newtown	100.00	''	''
Art Holycross, 16 Montrose Way, Nollamara, WA	100.00	''	''
Mrs Karen Hong, 17 Mccrae Close, Scoresby	100.00	''	''
Beverly Hong-Fincher, Asian Studies Faculty ANU, Canberra, ACT	120.00	''	''
Kerrie Hood, 55 Grosvenor Street, Neutral Bay NSW	106.40	''	28/04/00
Kerrie Hood, 55 Grosvenor Street, Neutral Bay, NSW	133.00	''	27/10/00
Hing Lee Hooi, 52/24 Dunmore Terrace, Auchenflower, Qld	100.00	''	''
Mr Hing Lee Hooi, 59 Pandora Drive, City Beach, WA	1,121.35	''	28/04/00
Mrs Serina Ai Ling Hooi, 59 Pandora Drive, City Beach, WA	904.65	''	''
Virginia Danielle Hookham, 19 Pembroke Place, Belrose, NSW	100.00	''	27/10/00
Ms Ruth L Hooley, 11/15 Marsden Street, Granville, NSW	100.00	''	''
John Phillip Hooper, 3/121 Edward St, Osborne Park, WA	150.00	''	''
Antony Bramston Hooper & Kerry Elizabeth James & Hooper James Consultants, 10 Curtin Avenue, Wahroonga, NSW	120.00	''	28/04/00
Carrie Hooper, PO Box 184, Mudgee, NSW	100.00	''	27/10/00
Ms Kathleen D. Hooper, 6 Oxford Parade, Forest Lake, Qld	115.45	''	28/04/00
Hooperbailie Industries Pty Ltd, PO Box 568, Noble Park	151.00	''	27/10/00
Gregory Neil Hope & Gael Hope, 36 Payne Street, Mulwala, NSW	100.00	''	''
Chun Ying Hor, 6/15 Lane Cove Road, Ryde, NSW	100.00	''	''
Horizon Systems Consulting Pty Ltd, 3 Waterloo Road, North Epping, NSW	800.00	''	28/04/00
Josephine May Lin Horne & Nestor Horne, 2 Pearce Ridge, Winthrop, WA	100.00	''	27/10/00
Andrew Gilbert Horne, 3 Francis Street, Longueville, NSW	144.95	''	28/04/00
Andrew Gilbert Horne, 3 Francis Street, Longueville, NSW	240.00	''	27/10/00
Michael Hornsby, 14 Empress Road, Surry Hills NSW	301.55	''	28/04/00
Michael Hornsby, 14 Empress Road, Surry Hills, NSW	500.00	''	27/10/00
Anne Hornstra, PO Box 166, Sherwood, Qld	100.00	''	''
Anne Hornstra, "Grace Hornstra A/c", RMB 166, Sherwood, Qld	100.00	''	''
Anne Hornstra, "Michael Hornstra A/c", RMB 166, Sherwood, Qld	100.00	''	''
Anne Maree Hornstra, "David Hornstra A/c", RMB 166, Sherwood, Qld	100.00	''	''
Joan Horsfall, 6 Scattergood Place, Spence, ACT	100.00	''	''
Pauline Horsnell, PO Box 30, Oakbank, SA	200.00	''	''
Mr John Horsnell, PO Box 30, Oakbank, SA	200.00	''	''

Anna Zofia Mirecka Horsten, 98 Felstead Street, Everton Park, Qld	100.00	''	28/04/00
Dorina Antonella Hortin, 190 Kew Street, Kewdale, WA	140.00	''	27/10/00
Ian Horton, 16 Lang Road, Kenthurst, NSW	128.00	''	''
Donald Horton, 16 Lang Road, Kenthurst, NSW	128.00	''	''
Horwich Holdings Pty Ltd, "Provident Fund A/c", 11 Balls Head Road, Waverton, NSW	112.00	''	28/04/00
Horwich Holdings Pty Ltd, "Provident Fund A/c", 11 Balls Head Rd, Waverton, NSW	140.00	''	27/10/00
Keith Hoskins & Emily Hoskins, 5/40 First Avenue, Loftus, NSW	100.00	''	''
Hospital Laundry Services P/L, Factory 4, 49 Garden Drive, Tullamarine	110.00	''	''
Ms Virginnia Margaret Hottes, 8/13 Nook Avenue, Neutral Bay, NSW	100.00	''	''
Afsaneh Hourfar & Airen Youhanna, 32/3 Cottell Way, Baulkham Hills, NSW	100.00	''	''
Julie Hourigan, 6/39 Southey Street, Elwood	100.00	''	''
Leslie Houseman, 7 Nelson Road, Lindfield, NSW	150.00	''	''
Mr Diarmuid Michael James Houston, PO Box 418, Kuranda, Qld	400.00	''	28/04/00
David Robert Hovenden, 82 Napier Crescent, Essendon	100.00	''	27/10/00
Claude Ivan Howard & Colleen Dawn Howard, PO Box 464, Yass, NSW	100.00	''	''
Robyn Howard, PO Box 7088, Lismore Heights, NSW	120.00	''	''
Steven John Howard, "Est Barry Paton A/c," 197 Old Canterbury Road, Dulwich Hill, NSW	460.00	''	''
Mr Ross Stephen Howard, 30 The Esplanade, Jacobs Well, Qld	200.00	''	''
John James Howard, 35 Kooloona Crescent, West Pymble, NSW	100.00	''	''
Max Lawrence Howard, 12 Stack Street, Balmain, NSW	100.00	''	''
Peter Alan Howe, PO Box 537, Busselton, WA	100.00	''	''
Craig C. Howie, 2 Waebra Court, Chadstone	188.30	''	''
Campbell Barton Howie, 31 Central Park Rd, Malvern East	140.00	''	''
Katrina Howison, 13A Smarts Cres, Cronulla, NSW	110.00	''	''
Tristan Howison, 13A Smarts Cres, Cronulla, NSW	110.00	''	''
Stephanie Howison, 13A Smarts Cres, Cronulla, NSW	110.00	''	''
Greg Howison, 13A Smarts Cres, Cronulla, NSW	110.00	''	''
Benjamin Howison, 13A Smarts Cres, Cronulla, NSW	110.00	''	''
Gregory John Howison & Stephanie Anne Howison, 13a Smarts Crescent, Cronulla, Nsw	150.00	''	''
Suzzane Therease Hoyne & Mark John Genney, 117 Park Road, Cheltenham	100.00	''	''
Luciana Hristianopoulos & Antonios Hristianopoulos, 31 Hanworth St, Balcatta, WA	100.00	''	''
Richard Yao-Jen Hsu, 7th Floor, 291 Chung Hsiao East Road, Section 5, Taipei	200.00	''	''
Mrs Mei-Ling Hsu, 2 Melissa Place, Cherrybrook, NSW	300.00	''	''
Ms Hui Ying Hsu, Fl 12, No. 18 Hsin Chen Road, Jiu Chiu Tang, Kaohsiung Hsien, Taiwan	475.00	''	''
Mr Bang Chanh Hua, 54 Hawkhurst Street, Spotswood	200.00	''	''
Jason C. Huang, 86 Hinkler Road, Glen Waverley	315.00	''	''

Albert Huang & Atsuko Katano, 323A High Street, Chatswood, NSW	166.40	''	28/04/00
Albert Huang & Atsuko Katano, 323A High Street, Chatswood, NSW	208.00	''	27/10/00
Zheng Guo Huang, 126 Lakemba Street, Lakemba, NSW	100.00	''	''
Chernee Lee Hubber, PO Box 1141, Bunbury, WA	100.00	''	''
Annette Huddy, 157 Martyn Street, Manunda Cairns, Qld	120.00	''	''
William Hudson, 54 Richelieu Street, Maidstone	100.00	''	''
Mr Stuart James Hudson, 12/30 Murphy Street, South Yarra	124.60	''	''
Virginia Jane Hudson & Simon Eric Jones, "Hudson-Jones Family A/c", 88 Watt Street, Spotswood	100.00	''	''
Mrs Melinda Jane Hudson, 1111 Bradfield Crescent, Sherwood Village, Dainfern Johannesburg, South Africa	160.00	''	''
Mr Harris Hudson, PO Box 294, Scullin, ACT	100.00	''	''
Van Kim Hue, 12 Harkness Street, Monash, ACT	100.00	''	''
Kylie Marie Huggett, 15 Warwillah Rd, Russell Lea, NSW	120.00	''	''
Vincent Anthony Hughes, 28 Bursill St, Guildford NSW	120.70	''	28/04/00
Vincent Anthony Hughes, 28 Bursill St, Guildford, NSW	200.00	''	27/10/00
Pamela May Hughes, 10 Stott Place, Stirling, SA	120.00	''	''
Sharon Hughes & Russell Johnstone, 34 Grandview Crescent, Upper Ferntree Gully	220.00	''	''
Miss Oriel Gwynneth Hughes, PO Box 14, Coorparoo, Qld	128.00	''	28/04/00
Mr Kerry Hughes & Mrs Sharron Eileen Hughes, PO Box 745, Boronia	200.00	''	27/10/00
Paul William Hughes, 22 Anne William Drive, West Pennant Hills, NSW	100.00	''	''
Ms Jackie Mary Hughes, PO Box 68, Kew East	100.00	''	''
Miss Oriel Gwynneth Hughes, PO Box 14, Coorparoo, Qld	482.35	''	28/04/00
Hughes Industries Pty Ltd, 4 Dobson Crescent, Baulkham Hills, NSW	100.00	''	27/10/00
Jason Philip Hughston, PO Box 776, Victoria Park, WA	260.00	''	''
Lau Joseph Hui Hui & Chung Nguik Mee, PO Box 197, St Lucia, Qld	157.05	''	28/04/00
Lau Joseph Hui Hui & Chung Nguik Mee, PO Box 197, St Lucia, Qld	260.00	''	27/10/00
Lorraine Veronica Humphrey, 15 Andrew Court, Pakenham	100.00	''	''
Anthony John Humphreys, PO Box 6, Launceston, Tas.	190.00	''	''
Mr Sam Humphris & Miss Megan Humphris, 82 Powlett Street, East Melbourne	100.00	''	''
Fung Kam Hung, 108/1618 Wassell Street, Matraville, NSW	100.00	''	''
Miss Samantha Sze Hung, 1 Stanhope Road, Killara, NSW	140.00	''	''
Man Chor Hung, 36A Whittens Lane, Doncaster	315.00	''	''
Harold Ernest Hunt & Elizabeth Harrison Hunt, 4B Rockton Rd, Nedlands, WA	100.00	''	''
Leonty Marie Hunt, 23 Elizabeth Street, Rooty Hill, NSW	100.00	''	''
Mr Whynton Alan Hunt, Unit 3, 5 Stewart Street, Scarborough, WA	280.00	''	28/04/00
Mr Whynton Alan Hunt, Unit 3, 5 Stewart Street, Scarborough, WA	350.00	''	27/10/00
Mr Adam Richard Hunt, 5/208 Alison Rd, Randwick, NSW	100.00	''	''
Mr Edward Charles Hunt & Mrs Deborah Elizabeth Hunt, 221 Haly St, Kingaroy, Qld	100.00	''	''

Mr Troy Antony Hunter, Unit 5, 489 Bronte Road, Bronte, NSW	160.00	”	28/04/00
Mr Troy Antony Hunter, Unit 5, 489 Bronte Road, Bronte, NSW	200.00	”	27/10/00
Malcolm Ernest Hunter, 61 Turner Street, Augusta, WA	260.00	”	”
Maurice Hunter & Joyce Mary Hunter, “Anthony M Hunter A/c”, 4 Vonne Court, Camp Mountain, Qld	112.00	”	28/04/00
Maurice Hunter & Joyce Mary Hunter, “Anthony M Hunter A/c”, 4 Vonne Court, Camp Mountain, Qld	140.00	”	27/10/00
Maurice Hunter & Joyce Mary Hunter, “Catherine J Hunter A/c”, 4 Vonne Court, Camp Mountain, Qld	140.00	”	”
Bradley Paul Hunter, 3 Swallow Court, Churchlands, WA	100.00	”	”
Mr John Hunter, 16 Old Bathurst Road, Woodford, NSW	120.70	”	28/04/00
Morgan Suzanne Hunter & Bradley Paul Hunter, “Hunter Family Trust A/c MSH”, C/- Whitines, PO Box 1340, Osborne Park, WA	100.00	”	27/10/00
Denham Bradley Hunter & Bradley Paul Hunter, “Hunter Family Trust A/c DBH”, C/- Whitings, PO Box 1340, Osborne Park, WA	100.00	”	”
Jacqueline Paull Hunter & Bradley Paul Hunter, “Hunter Family A/c”, C/- Whitings, PO Box 1340, Osbourne Park, WA	100.00	”	”
Joyce M. Hunter, 4 Vonne Court, Camp Mountain, Qld	576.00	”	28/04/00
Joyce M. Hunter, 4 Vonne Court, Camp Mountain, Qld	720.00	”	27/10/00
Maurice P. Hunter, 4 Vonne Court, Camp Mountain, Qld	576.00	”	28/04/00
Maurice P. Hunter, 4 Vonne Court, Camp Mountain, Qld	720.00	”	27/10/00
David Huntley, 72 Plenty Lane, Greensborough	140.00	”	”
Kenneth Hurn, 46 Murrumbidgee Drive, Echuca	100.00	”	”
Janine Hurn, 46 Murrumbidgee Drive, Echuca	100.00	”	”
Hurry Last Days Pty Ltd, 1 Ian Avenue, North Curl Curl NSW	640.00	”	28/04/00
Hurry Last Days Pty Ltd, 1 Ian Avenue, North Curl Curl, NSW	800.00	”	27/10/00
Kym William Hursell, 4/40 Virginia St, Wollongong, NSW	100.00	”	”
Mr David John Hurst, 2 Bond Street, Willaston, SA	111.60	”	28/04/00
Susan Wendy Huse, 65 Mulcahy Road, Pakenham	160.00	”	27/10/00
Alister Ian Huth, 153 Ballantyne Street, Thornbury	100.00	”	”
Neale Huth, PO Box 10533, Adelaide Street, Brisbane, Qld	100.78	”	28/04/00
Neale Huth, PO Box 10533, Adelaide Street, Brisbane, Qld	166.60	”	27/10/00
Neale Stewart Huth, 16/16 Barnsley Street, West End, Qld	100.78	”	28/04/00
Neale Stewart Huth, 16/16 Barnsley Street, West End, Qld	166.60	”	27/10/00
Mrs Elizabeth Leanne Huth & Mr Michael William Huth, 39 Bute Street, Sherwood, Qld	150.00	”	”
Michelle Hutson, 15 Shannon Close, Woodvale, WA	120.70	”	28/04/00
Michelle Hutson, 15 Shannon Close, Woodvale, WA	200.00	”	27/10/00
Mr Peter Huxley & Mrs Linda Huxley, “The Huxley Super Fund A/c”, 111 Livingstone Avenue, Pymble, NSW	960.00	”	”

Mr Peter Huxley & Mrs Linda Huxley, "The Huxley Super Fund A/c", 111 Livingstone Ave, Pymble, NSW	300.00	"	"
Aaron Huynh, 32 McCrossin Avenue, Birrong, NSW	140.00	"	"
Linh Thi Huynh, 251 Drake Street, Morley, WA	100.00	"	"
Mr Duc Bao Huynh, 83 Elizabeth Street, Richmond	100.00	"	"
Yann Ling Hwang, 1/69 Malcolm Street, West Perth, WA	200.00	"	"
Hycon Australia Data & Electrical Pty Ltd, 31 Kardinia Drive, Yallambie	100.00	"	"
Lawrence Hyde, 16 Renny Street, Paddington, NSW	100.00	"	"
Alan Hyde, PO Box 39672, Winnellie, NT	151.00	"	28/04/00
Alan Hyde, PO Box 39672, Winnellie, NT	250.00	"	27/10/00
Hydrasol Pty Ltd & Russell Charles Price, "Super Fund A/c", PO Box 248, Young, NSW	100.00	"	"
Kieran Hynes, 308 Kingston Park, Griffith, ACT	100.00	"	"
Frank Iannuzzelli, 50 Como Road, Oyster Bay, NSW	249.60	"	28/04/00
Rosalie Iannuzzelli, 9 Tennant Street, CASULA, NSW	100.00	"	27/10/00
Jeremy Iannuzzelli, 9 Tennant Street, Casula, NSW	100.00	"	"
Tony Iaria, 53-55 Canterbury Road, Montrose	140.00	"	"
Hugh Bennet Ibbotson & Susanne Kathryn Ibbotson, 2 Azalea Court, Knoxfield	112.00	"	28/04/00
Idem Pty Ltd, 18 Stack Street, Fremantle, WA	120.00	"	27/10/00
Idem Pty Ltd, 18 Stack Street, Fremantle, WA	100.00	"	"
Idem Pty Ltd, 18 Stack Street, Fremantle, WA	112.00	"	28/04/00
Idem Pty Ltd, 18 Stack Street, Fremantle, WA	140.00	"	27/10/00
Vithianny Iem, 12/46 Dartbrook Road, Auburn, NSW	138.90	"	28/04/00
Vithianny Iem, 12/46 Dartbrook Road, Auburn, NSW	230.00	"	27/10/00
Laurence Melville Iffla, "Iffla Family A/c", 8 Walter Street, Claremont, WA	144.95	"	28/04/00
Laurence Melville Iffla, "Iffla Family A/c", 8 Walter Street, Claremont, WA	240.00	"	27/10/00
IFS (Med) Pty Ltd, "Super Fund A/c", 44 Billyard Avenue, Wahroonga, NSW	603.10	"	28/04/00
Mrs Nilufer Ilhan, PO Box 3072, Broadmeadows Shopping Centre, Broadmeadows	120.00	"	27/10/00
Harry Illingworth & Gwen Illingworth, PO Box 339, Moss Vale, NSW	100.00	"	"
Imperic Pty Limited, PO Box 1041, Crows Nest, NSW	160.00	"	28/04/00
Imperic Pty Limited, PO Box 1041, Crows Nest, NSW	200.00	"	27/10/00
Peter Ind, 67 McLean Street, Coolangatta, Qld	160.00	"	28/04/00
Info Power (Aust) Pty Ltd, 3/107 Alison Road, Randwick, NSW	260.00	"	27/10/00
Nicholas Inglis, 44 Crest Street, Mount Gravatt, Qld	100.00	"	"
Sharlene P. Ingram, 11 Sycamore Street, Camberwell	240.00	"	28/04/00
Graeme Inkster, 16/7 Gardea Street, Pelopea, NSW	120.70	"	"
Graeme Inkster, 16/7 Gardea Street, Pelopea, NSW	200.00	"	27/10/00
Integrated Memory Systems Pty Ltd, Research Park, Bond University, Qld	140.00	"	"
Lafayette International, Level 2, 263 George Street, Sydney, NSW	301.55	"	28/04/00
Lafayette International, Level 2, 263 George Street, Sydney, NSW	500.00	"	27/10/00
International Negotiations Pty Ltd, PO Box 5115, Kingston, ACT	125.00	"	"

International Negotiations Pty Ltd, PO Box 5115, Kingston, ACT	120.70	''	28/04/00
International Negotiations Pty Ltd, PO Box 5115, Kingston, ACT	200.00	''	27/10/00
International Sports Television Pty Ltd, "ISTV Super Fund A/c", GPO Box 5456, Sydney, NSW	800.00	''	''
International Sports Television Pty Ltd, GPO Box 5456, Sydney, NSW	800.00	''	''
International Trading Company Pty Ltd, "ITC Pty Ltd Super Fund A/c", 154-160 Gilles Street, Adelaide, SA	200.00	''	27/10/00
Interprop Pty Ltd, Level 2, 111 Collins Street, Melbourne	640.00	''	28/04/00
Interprop Pty Ltd, Level 2, 111 Collins Street, Melbourne	800.00	''	27/10/00
Tonietta Iogha, 14 Pritchard Street, Mount Pritchard, NSW	200.00	''	''
Frank Iorfino & Lisa Traianedes, 23 Fellows St, Mitcham	160.00	''	''
Lilian Ip, 2 Ottway Close, St Ives, NSW	100.00	''	''
Mr Noshewan Byram Irani, 33 Provincial Road, Lindfield, NSW	310.00	''	''
Chris Ireland, 21 Armmeay Road, Remuera, Auckland, NZ	500.00	''	''
Justin Irons, 58 Finlay Street, Bankstown	100.00	''	''
Heather Irvine, PO Box 1463, Wodonga	120.70	''	28/04/00
Margaret Irvine, 36 Sunny Avenue, Wavell Heights, Qld	120.70	''	''
Margaret Irvine, 36 Sunny Avenue, Wavell Heights, Qld	200.00	''	27/10/00
David Irvine, "Dw Irvine S Fund A/C", 7 Cornish Place, Aspley, Qld	200.00	''	''
Margaret Shane Isaac, 6 Rotherwood Road, East Ivanhoe	168.00	''	''
Mr Maurice Isaac, 19 Moons Avenue, Lugarno, NSW	100.00	''	''
Isaac Mordecai Pty Ltd, "Super Fund A/c", 14/78 Wolseley Road, Point Piper, NSW	200.00	''	''
Mrs Ran Ishida, 15 The Esplanade, Drummoyne, NSW	200.00	''	''
Mr Tatsuya Wesley Ishizaki, 20-10-307 Ichiban-Cho, Tokyo 102-0082 Japan	1,100.00	''	''
Rodney Ison, 14 Cawarra Street, Ballina, NSW	297.00	''	''
Rodney Ison, 19 Simmons Street, Lismore, NSW	280.00	''	''
Felicity M. Ison, PO Box 449, Lismore, NSW	240.00	''	''
Richard Ison, 19 Simmons Street, North Lismore, NSW	308.00	''	''
Jean Ison, 14 Cawarra Street, Ballina, NSW	240.00	''	''
Rodney Ison, PO Box 150, Coraki, NSW	200.00	''	''
Mr Richard Ison, 19 Simmons Street, Lismore, NSW	240.00	''	''
Iterum Pty Ltd, 33 Summerhill Ave, East Malvern	120.70	''	28/04/00
Boris Ivancic, "Ivancic Super Fund A/c", 64 May Road, Beaconsfield	120.00	''	27/10/00
Alexandra Ivanidis, 22 Allister Street, Mount Waverley	676.00	''	''
J & K Newcombe Pty Ltd, "The Newcombe Family S/F A/c", 7 Rees Street, Kelvin Grove, Qld	100.00	''	''
J. J. K. Investments P/L, 1 Ibis Court, Patterson Lakes	100.00	''	''
J. J. K. Trading P/L, 1 Ibis Court, Patterson Lakes	100.00	''	''
J. McIntosh Pty Ltd, "Jm Nirvana S/F A/C", 23 Averdeen Grove, Northcote	110.00	''	''
J. R. Superannuation Pty Ltd, "JR Superannuation Fund A/C", 50 Blackwood Park Road, Ferntree Gully	241.45	''	28/04/00

J. R. Superannuation Pty Ltd, "JR Superannuation Fund A/c", 50 Blackwood Park Road, Ferntree Gully	400.00	"	27/10/00
J. W. Buchanan Pty Ltd, "Super Fund A/c", 8 Percy Street, Balwyn	132.85	"	28/04/00
J. W. Lock Pty Ltd, "J. W. Lock Superannuation A/c", C/- Tower Trust, GPO Box 860, Adelaide, SA	100.00	"	27/10/00
Mr Ahmed Zakki Abdul Jabbar, 29/75 Drummond Street, Carlton	100.00	"	"
Jabil Nominees Pty Ltd, "Koutsantonis Family A/c", 156 Haughton Road, Huntingdale	100.00	"	"
William Alexander Jack, 20 Thanet Street, Malvern	127.90	"	28/04/00
William Alexander Jack, 20 Thanet Street, Malvern	212.00	"	27/10/00
Christopher John Jack, PO Box 41, Bencubbin, WA	100.00	"	"
Isobel Mary Willet Jack, 136 Edinburgh Road, Castlecrag, NSW	149.70	"	"
Fiona Jack, 20 Thanet Street, Malvern	127.90	"	28/04/00
Fiona Jack, 20 Thanet Street, Malvern	212.00	"	27/10/00
Mr Bruce Ian Jackson, 2 Nix Avenue, Malabar, NSW	170.00	"	"
Shaun Peter Jackson, Edgewater Quays, 7/167 Wynnum Esplanade, Wynnum, Qld	208.00	"	28/04/00
Shaun Peter Jackson, Edgewater Quays, 7/167 Wynnum Esplanade, Wynnum, Qld	130.00	"	27/10/00
Brian Alan Jackson, 113 Wattle Road, Jannali, NSW	260.80	"	28/04/00
Mrs Joy Lesley Jackson, C/- Wilson Htm Ltd, PO Box 222, Hervey Bay, Qld	192.00	"	"
Michael Jacob & Vijay Lakshmi Jacob, 26 Cormorant Avenue, Hinchinbrook, NSW	100.00	"	27/10/00
Matthew Jacobs, 2/17 Woodbine Street, Balgowlah North, NSW	149.00	"	"
Ariela Jacobs, C/-11 Wanda Road, Caulfield	100.00	"	"
Adina Jacobs, C/-11 Wanda Road, Caulfield	100.00	"	"
Steven Jacquier & Tania Jacquier, 4 Riverway Place, Kidman Park, SA	100.00	"	"
Robin George Jakins, 27 Lamberth Road, Regents Park, Qld	176.00	"	28/04/00
Robin George Jakins, 27 Lamberth Road, Regents Park, Qld	220.00	"	27/10/00
Sharon Maria Jaklofsky, 26 East Street, Dubbo, NSW	128.00	"	"
Mr Rick Jaksch, 12b Chivers Road, Templestowe	252.00	"	28/04/00
Jorry Jakubovic, 1/1 Mutz Street, North Caulfield	183.40	"	27/10/00
John Allan James & Colleen Jill James, 42 Kinnard Way, Kellyville, NSW	112.00	"	28/04/00
Jannine Eileen James, PO Box 284, Alyangula, NT	120.00	"	"
Anita Jane James, PO Box N278, Sydney, NSW	120.70	"	"
David Boyd James, 886 Station Street, Box Hill North	152.00	"	"
David Boyd James, 886 Station Street, Box Hill North	190.00	"	27/10/00
Wendy Susan James, 8 Anchor Place, Safety Bay, WA	120.70	"	28/04/00
Wendy Susan James, 8 Anchor Place, Safety Bay, WA	200.00	"	27/10/00
Gregory James, 8 Anchor Place, Safety Bay, WA	120.70	"	28/04/00
Gregory James, 8 Anchor Place, Safety Bay, WA	200.00	"	27/10/00
Mr David Charles James, 6 Mepsted Crescent, Athelstone, SA	100.00	"	"
Colin Mervyn James & Patricia Mavis James, 5C Taylor Street, Rockhampton North, Qld	140.00	"	"

Margaret Miller Jamieson, 3/14 Manningtree Rd, Hawthorn	100.00	''	''
Miss Sue Ellen Jamieson, Euston Lodge, Stoke Road, Clare, Suffolk CO10 8HG	554.25	''	28/04/00
Miss Sue Ellen Jamieson, Euston Lodge, Stoke Road, Clare, Suffolk CO10 8HG	750.00	''	27/10/00
Ms Penelope Jane Jamieson & Ms Shana Louise Jamieson & Mr Blair David Jamieson, 27 Hovea Crescent, City Beach, WA	100.00	''	''
Richard Hillary Jamieson & Angela Ruth Jamieson, 529 Lockyer Avenue, Paraburdoo, WA	120.00	''	''
Jammon Services Pty Ltd, 15 Bakewell St, Tusmore, SA	100.00	''	''
David D. Jan, PO Box 38618, Winnellie, NT	110.00	''	''
Janatos Pty Ltd, 130 Beecroft Road, Beecroft NSW	252.00	''	28/04/00
Janatos Pty Ltd, 130 Beecroft Road, Beecroft, NSW	315.00	''	27/10/00
Roman Janczuk, 10 Boscowan Crescent, Bellbird Park, Qld	555.00	''	''
Barbara Janczuk, 10 Boscowan Crescent, Bellbird Park, Qld	555.00	''	''
Stephen J. Jannese, PO Box 208, Yagoona, NSW	132.85	''	28/04/00
Stephen J. Jannese, PO Box 208, Yagoona, NSW	220.00	''	27/10/00
Janru Investments Pty Ltd, 1 John Street, Innisfail, Qld	400.00	''	''
Ruth Marjorie Jansen & Charles Rick Jansen, 670 Hampton Street, Brighton	100.00	''	''
Mr Daniel Jap, 11/37 Oak Street, Ashfield, NSW	100.00	''	''
Mrs Yvonne Jarick, 29 Johnstone Street, Peakhurst, NSW	120.70	''	28/04/00
Mrs Yvonne Jarick, 29 Johnstone Street, Peakhurst, NSW	200.00	''	27/10/00
Falgun Jariwala, 114/22 Great Western Highway, Parramatta, NSW	128.00	''	28/04/00
Richard J. Jarrett, Lot 16, Martin Street, Coraki, NSW	250.00	''	27/10/00
Jarr Holdings Pty Ltd, "J & R Singh Trust A/c", Unit 20/147, Grande Parade, Monterey, NSW	100.00	''	''
Jaslob Pty Ltd, "Werbelloff S/F A/c", 59/1 Koorunga Road, Chatswood, NSW	400.00	''	''
Jasmarr Pty Ltd, 4 Lane Cove Road, Ingleside, NSW	105.00	''	''
Tyrone W. Jaspers, 184 Ross Street, Port Melbourne	376.00	''	28/04/00
Tyrone W. Jaspers, 184 Ross Street, Port Melbourne	470.00	''	27/10/00
Jacqueline Isobel Jauncey-Cooke & Matthew Gerard McFadden, 50 School Road, The Gap, Qld	100.00	''	''
Peter Andrew Jay, 138 Commerce Street, Taree, NSW	100.00	''	''
Usha Jayaswal, 32 Danielle Street, Cleveland, Qld	212.00	''	''
Dr Dylan Jayatilaka, Unit 2/17 The Avenue, Nedlands, WA	150.00	''	''
Peter Jenetsky, 23 Brereton Street, Gladesville, NSW	100.00	''	''
David Randal Jenkins & Samantha Jane Chadwick, 4/25 Sackville Terrace, Scarborough, WA	100.00	''	''
Mr Michael Jenkins, 2A The Boulevard, Balwyn North	120.00	''	28/04/00
Mr Anthony Stephen Jenkins, PO Box 52, Derby, WA	100.00	''	27/10/00
Noel Jenkins, PO Box 4198, East Richmond	132.85	''	28/04/00
Mr Anthony Steven Jenkins & Ms Heather Anne Jenkins, "Jenkins Family Super A/c", 55 Panguna Street, Trinity Beach, Qld	150.00	''	27/10/00
Sydney Terrence Jenkins, 15 Shalvey Close, Duncraig, WA	120.70	''	28/04/00
Sydney Terrence Jenkins, 15 Shalvey Close, Duncraig, WA	200.00	''	27/10/00
Mr Max Jenkins, PO Box 284, Alyangula, NT	100.00	''	''
Mr Andrew Philip Jennings, PO Box 635, Forestville, NSW	101.00	''	''
Mark Andrew Jennings, PO Box 870, Belmont	100.00	''	''
Joan Margaret Jennings, PO Box 1149, Canning Vale, WA	150.00	''	''

Mrs Diane Rose Jensen, 11 Mina Street, Toowoomba, Qld	240.00	''	28/04/00
Jenta Investments Pty Ltd, PO Box 577, Armadale, WA	240.00	''	27/10/00
Ric Jentzsch & Barbara Ledger, PO Box 4693, Kingston, ACT	100.00	''	''
Jenwo Pty Ltd, "Oliver Family A/c", C/-Tower Trust,GPO Box 546, Adelaide, SA	181.30	''	28/04/00
Jenza Pty Limited, C/- Mr James Harvey, Grant Thornton, GPO Box 1270, Adelaide, SA	500.00	''	27/10/00
Jenza Pty Ltd, 54 Clifton Street, Prospect SA	240.00	''	''
Jenza Pty Ltd, 54 Clifton Street, Prospect, SA	151.50	''	''
Alma M Jeremiah, 9 Narrell Court, Sunnybank Hills, Qld	190.70	''	28/04/00
Alma M. Jeremiah, 9 Narrell Court, Sunnybank Hills, Qld	316.00	''	27/10/00
Mr Andrew Jerram, PO Box 305, Kew	112.00	''	28/04/00
Michael Anthony Jesina, 51 Lea Road, Mulgrave	100.00	''	27/10/00
Jetblack Nominees Pty Ltd, "The Rankine-Wilson S/F A/C", 30 Bates Way, Warnbro, WA	181.30	''	28/04/00
Neerja Jha, 10 Waverley Park Drive, Cranbourne	140.00	''	27/10/00
Mr Xiao Xi Jia & Mrs Xiao Yan Kang, 22 Forrest Road, Ryde, NSW	200.00	''	''
Xiao Fang Jiang, 98 Bellevue Parade, Hurstville, NSW	200.00	''	''
Mrs Xiao Chun Jiang, 40 Frederick St, Pendle Hill, NSW	100.00	''	''
Jias Malpco, PO Box 177, Eltham	220.00	''	''
Mr Chiong Hung Jiew, PO Box 368, Rundle Mall PO, SA	100.00	''	''
Jimco Developments Pty Ltd, "Iliopoulos Family Super A/c", 51 Oakland Drive, Warrandyte	250.00	''	''
Sarsam Anne Joargenson, 4/251 Melody Court, Warana, Qld	100.00	''	''
Joe Cross Pty Limited, "Superannuation Fund A/c", PO Box N656, Grosvenor Place, Sydney, NSW	112.00	''	28/04/00
William Joseph Joeh & Teresa Joeh, 96 Horizon Drive, Middle Park, Qld	100.00	''	27/10/00
Raymond Joff & Kathryn Abbott, Post Office, Coolup, WA	100.00	''	''
Jogwen Pty Ltd, 16 Donald Street, Guildford, NSW	160.00	''	28/04/00
Jogwen Pty Ltd, 16 Donald Street, Guildford, NSW	200.00	''	27/10/00
Joan Johannsen & Lindsay Johannsen, RMB 41, Alice Springs, NT	150.00	''	''
Diane Eileen John & Michelee Diane John & Graeme David John, PO Box 513, Cheltenham	100.00	''	''
Ms Fiona Margaret John, 192 Moore Road, Millendon, WA	112.00	''	28/04/00
John Gillroy & Associates Pty Ltd, PO Box 708, Strawberry Hills, NSW	140.00	''	27/10/00
John L Robertson Pty Ltd, PO Box 4007, Loganholme, Qld	236.50	''	28/04/00
John L. Robertson Pty Ltd, PO Box 4007, Loganholme, Qld	392.00	''	27/10/00
John Louise Pty Ltd, "Aust Strategic Exec S/F A/c", C/- Lek, Lvl 10, IBM Tower, 160/160 City Road, Southbank	672.00	''	28/04/00
John Louise Pty Ltd, "Aust Strategic Exec S/F A/c", C/- Lek, Lvl 10, IBM Tower, 160/160 City Rd, Southbank	840.00	''	27/10/00
John Martin Kozlowski Pty Ltd, "Kozlowski Family A/c", 33A Garthowen Crescent, Castle Hill, NSW	320.00	''	''
John Newing Pty Ltd, C/- London Partners PAS, PO Box 748, West Perth, WA	120.70	''	28/04/00

John Storey Pty Limited, East Point Tower, 509/180 Ocean Street, Edgecliff, NSW	220.00	''	27/10/00
Renee Jeanne Johnson & Timothy Robert Johnson, 3 The Crescent, Vaucluse, NSW	220.00	''	''
Dorothy Joan Johnson, GPO Box 2850AA, Melbourne	100.00	''	''
Tania Lee Johnson & Trevor Lindsay Johnson, 45 Amy Loop, Craigie, WA	169.60	''	28/04/00
Tania Lee Johnson & Trevor Lindsay Johnson, 45 Amy Loop, Craigie, WA	212.00	''	27/10/00
Reginald Johnson, GPO Box 2850AA, Melbourne	100.00	''	''
Randolph Johnson, 35 Jasmine Avenue, Quakers Hill, NSW	120.00	''	''
Monica Johnson, 35 Jasmine Avenue, Quakers Hill, NSW	100.00	''	''
Fiona Johnson, 35 Jasmine Avenue, Quakers Hill, NSW	140.00	''	''
Edna May Johnson, 181 Mount Ommanry Drive, Jindalee, Qld	168.00	''	28/04/00
Edna May Johnson, 181 Mount Ommanry Drive, Jindalee, Qld	210.00	''	27/10/00
Verne Barry Johnson, 5 Earl Street, Hunters Hill, NSW	140.00	''	''
Peter Antony Johnston, Po Box 62, Winton, Qld	100.00	''	''
Suzanne Agnes Johnston, 168 Macedon Road, Lower Templestowe	140.00	''	''
Joined Up Thinking Pty Ltd, C/- Ddb Advertising, 76 Berry Street, North Sydney, NSW	115.00	''	''
Joined Up Thinking Pty Ltd, "Blampied A/c", 34 Billyard Avenue, Elizabeth Bay, NSW	120.70	''	28/04/00
Joined Up Thinking Pty Ltd, "Blampied A/c", 34 Billyard Avenue, Elizabeth Bay, NSW	200.00	''	27/10/00
Peter Eduard John Jollie, 94 Elliott Street, Balmain, NSW	160.00	''	28/04/00
Valisia Jollie, 94 Elliott Street, Balmain, NSW	120.70	''	''
Raymond Maxwell Jolliffe, 64 Meredith St, Newcastle, NSW	120.00	''	27/10/00
Matthew David Jones, 175 Edgecliff Rd, Woollahra, NSW	100.00	''	''
Christopher John Jones, 6 Gatakers Lane, Point Vernon, Qld	100.00	''	''
Leo John Jones, 14 Wright Street, Essendon	160.00	''	28/04/00
Leo John Jones, 14 Wright Street, Essendon	200.00	''	27/10/00
Raymond John Jones, 19 Lauderdale Avenue, Fairlight, NSW	200.00	''	''
Raymond John Jones, 135 Harbord Road, Harbord, NSW	120.70	''	28/04/00
Mr Stephen Jones, C/- Fletcher Challenge Energ, Private Bag 92114, Auckland, New Zealand	118.24	''	''
Mr Darren Wayne Jones, Unit 22, 1 Leclair Place, Buderim, Qld	100.00	''	27/10/00
Noelene Gloria Jones, 12 Suburban Avenue, Ballarat	100.00	''	''
Peter Jones, 37 Owen Street, Mitcham	108.00	''	''
Mr Simon Jones & Ms Virginia Jane Hudson, 88 Watt Street, Spotswood	100.00	''	''
Mr Andrew David Jones, 2 Zeppelin Strasse, Gutersloh 33334 Germany	156.67	''	28/04/00
Kim Jun Jong, 31 Henry Kendall Cresce, Mascot, NSW	112.00	''	''
Kim Jun Jong, 31 Henry Kendall Cresce, Mascot, NSW	140.00	''	27/10/00
Kellie Anne Jorgensen, 3 Dulcie Court, Noble Park	160.00	''	28/04/00
Alex Joseph, PO Box 4181, Kalgoorlie, WA	100.00	''	27/10/00
Neville Joseph, 15 Harlingford Court, Wheelers Hill	100.00	''	''
Mrs Leah Joseph, 75 West Coast Drive, Waterman, WA	150.00	''	''
Gregory James Josephson, 25 George Street, North Hobart, Tas.	151.00	''	28/04/00
Anthony Colin Joyner, 45 Holland Street, Wembley, WA	120.70	''	''

Anthony Colin Joyner, 45 Holland Street, Wembley, WA Mr Kenneth Malcolm Judge, C/- Hawkins Christie Management Services, 168 Stirling Highway, Nedlands, WA	200.00	”	27/10/00
Julagee Pty Ltd, 212 Aqueduct Road, Diamond Creek	240.00	”	”
Julianne McLean Marketing Pty Ltd, “Mclean Marketing S/F A/c”, C/-Mrs Julianne McLean, 70 Wandeen Road, Clareville, NSW	140.00	”	”
Julianne McLean Marketing Pty Ltd, “Mclean Marketing S/F A/C”, C/-Mrs Julianne Mclean, 70 Wandeen Road, Clareville, NSW	102.40	”	28/04/00
Julman Pty Ltd, “Super Fund A/c”, 33 Aruma Way, City Beach, WA	128.00	”	27/10/00
Jun Chen, Unit 9, 14-16 Tintern Avenue, Carlingford, NSW	100.00	”	”
Jun Chen, Unit 9, 14-16 Tintern Avenue, Carlingford, NSW	172.80	”	28/04/00
Chan-Hack Jung & Seol Jung & Hyun Jung, 11 Orchard Place, Eight Mile Plains, Qld	216.00	”	27/10/00
Robert Junge, “Sarj Fund A/c”, PO Box 41, Cootamundra, NSW	180.00	”	”
Robert Junge, “Sarj Fund A/c”, PO Box 41, Cootamundra, NSW	112.00	”	28/04/00
Vlado Jurcic, “Jurcic Family A/c”, 309 La Trobe Terrace, Geelong	140.00	”	27/10/00
Ryszard Jurdeczka, 4 Crown Street, Epping, NSW	120.00	”	”
Ian Jurgens, 13/3 Durham Close, North Ryde, NSW	120.70	”	28/04/00
Ian Jurgens, 13/3 Durham Close, North Ryde, NSW	237.30	”	”
Mrs Valentina Jurkovic & Mr Boris D Jurkovic, 10 Patricia Avenue, Bundoora	393.00	”	27/10/00
Juss Investments Ltd, 28 Woodlands Rd, Taren Point, NSW	100.00	”	”
John R. Justice, 95 Humevale Road, Humevale	100.00	”	”
Wladyslaw Juszcze & Teresa Juszcze, “Luke John Brymora A/c”, 79 Cooper Road, Birrong, NSW	435.00	”	”
K. & G. Partners Pty Ltd, 45 C/O Minto Mall, Minto, NSW	100.00	”	”
K. & G. Partners Pty Ltd, 45 C/O Minto Mall, Minto, NSW	120.00	”	28/04/00
K. & H. Funds Management Pty Ltd, “K. & H. Super Fund A/c”, 18 Kendall Street, Elwood	150.00	”	27/10/00
K. Bamford Medical Pty Ltd, “Super Fund A/c”, PO Box 363, Burnside, SA	200.00	”	”
K. Chandler Wholesale Pty Ltd, “K Chandler Retirement A/c”, PO Box 442, Mount Martha	100.00	”	”
K. M. Electronic Developments Pty Ltd, 4 Faraday Road, Croydon South	150.00	”	”
K. M. Electronic Developments Pty Ltd, 4 Faraday Road, Croydon South	126.75	”	28/04/00
Mr Tesfaye Belay Kahsay, 20/4 Murray Avenue, Mosman Park, WA	210.00	”	27/10/00
Maxium Wharekawa Kahuroa & Margaret Kahuroa, 101 Hilma Street, Ardeer	111.10	”	”
Kalaburn Pty Ltd, 256 Queen Street, Melbourne	100.00	”	”
Gideon Kalatzis, 14 Estelle Street, Sunshine	100.00	”	”
Cebe Kalevski & Snezana Kalevska, 12 Tantallon Avenue, Arncliffe, NSW	420.00	”	”
	112.00	”	28/04/00

Cebe Kalevski & Snezana Kalevska, 12 Tantallon Avenue, Arncliffe, NSW	140.00	”	27/10/00
Frederik W Kalsbeek, 9 The Grange, Nerang, Qld	165.00	”	”
Kamabra Pty Ltd, “Super Fund A/c”, 449 Hammond Road, Dandenong	160.00	”	28/04/00
Kamabra Pty Ltd, “Super Fund A/c”, 449 Hammond Road, Dandenong	200.00	”	27/10/00
Anastasia Kambitsis, 6 Marina Crescent, Greenacre, NSW	127.90	”	28/04/00
Jeena Kambo, F-146 Malcho Marg, Diplomatic Enclave, N. Delhi 110 021 India	329.60	”	”
Kamo Pty Ltd, 6th Floor, 600 Bourke Street, Melbourne	838.40	”	28/04/00
Kamo Pty Ltd, 6th Floor, 600 Bourke Street, Melbourne	1,048.00	”	27/10/00
Richard Kamper, 73 Mowbray Road, Willoughby, NSW	100.00	”	”
Thomas John Supple Kane, 119/283 Spring St, Melbourne	100.00	”	”
Yung-Chou Kao, No 49-11 Liu-Lin Village, Shui-Shang Town, Chia-Yi County, Taiwan 608	201.01	”	28/04/00
Yung-Chou Kao, No 49-11 Liu-Lin Village, Shui-Shang Town, Chia-Yi County, Taiwan 608	272.00	”	27/10/00
Lois Kapernick, 2/57 Dunmore Terrace, Auchenflower, Qld	100.00	”	”
Lawrence Lyle Kappler, 162 Marks Landing, Swan Reach, SA	160.00	”	28/04/00
Lawrence Lyle Kappler, 162 Marks Landing, Swan Reach, SA	200.00	”	27/10/00
Dimitra Karanasis, 39a Sussex Street, Brighton	108.00	”	”
Daniella Dianne Cathy Kariotis & Sofia Kariotis & Dimitrios James Kariotis, 45 Solent Crescent, Taylors Lakes	100.00	”	”
Gamini J Kariyawasam & Shanthini R. Kariyawasam, 3/24 Kennedy Street, Kingsford, NSW	104.00	”	28/04/00
Gamini J Kariyawasam & Shanthini R. Kariyawasam, 3/24 Kennedy Street, Kingsford, NSW	130.00	”	27/10/00
Karpin Consultants Pty Ltd, 2 St Georges Court, Toorak	120.00	”	28/04/00
Karri Pty Limited, 48 Fergusson Crescent, Deakin, ACT	160.00	”	”
Mrs Nairi Kashkerian, Unit 22, 700 Victoria Rd, Ryde, NSW	120.00	”	27/10/00
Bessie Kass & Andreas Ilias Kass & Alexander John Kass, 6/27 Rickard Avenue, Bondi, NSW	260.00	”	”
Bessie Kass, 61 Latimer Road, Bellevue Hill, NSW	100.00	”	27/10/00
Bessie Kass, “Alexander John Kass A/c”, 61 Latimer Road, Bellevue Hill, NSW	100.00	”	”
Bessie Kass, 61 Latimer Road, Bellevue Hill, NSW	100.00	”	”
Samuel Katsambis, 20 Stone Street, West Preston	120.00	”	”
Athena Katsambis, 20 Stone Street, West Preston	120.00	”	28/04/00
Mr Charles Dennis Katz, C/- Mr R H Perlov, GPO Box 2646, Sydney, NSW	120.70	”	”
Mr Charles Dennis Katz, C/- Mr R. H. Perlov, GPO Box 2646, Sydney, NSW	200.00	”	27/10/00
John Kavanagh & Phyllis Pauline Kavanagh, GPO Box 886, Sydney, NSW	220.00	”	”
Chie Kawazoe, 19/18 Knockklayde Street, Ashfield, NSW	128.00	”	28/04/00
Gulbahar Kaya & Serif Kaya, “Young Turks Super Fund A/c”, 3A Mugga Way, Forrest, ACT	208.00	”	”
Gulbahar Kaya & Serif Kaya, “Young Turks Super Fund A/c”, 3A Mugga Way, Forrest, ACT	260.00	”	27/10/00
Kealba Nominees Pty Ltd, “Diamond Property A/c”, 29 Calverton Road, Kealba	104.00	”	28/04/00

Stephen Kearney & Morag Easton & Rowan Kingstone, 17 Weybridge Street, Surrey Hills	100.00	”	27/10/00
Stepehn Peter Kearney & Morag Piri Easton & Rowan Stanley Kingstone, 17 Weybridge Street, Surrey Hills	100.00	”	”
Kearney & Tyrrell Pty Ltd, 53 Rose Street, Essendon	100.00	”	”
Kearney And Tyrrell Pty Ltd, “Super Fund A/c”, 53 Rose Street, Essendon	217.20	”	28/04/00
Kearney And Tyrrell Pty Ltd, “Super Fund A/C”, 53 Rose Street, Essendon	360.00	”	27/10/00
Mr Adam Robert Keats, “McKeat Family A/c”, 30 Hewitt Avenue, Rose Park, SA	181.30	”	28/04/00
Robert Kechenovich & Jacqueline Kechenovich, “Kechenovich Superfund A/c”, 14 Aberfelde St, Essendon	160.00	”	27/10/00
Gizella Kechenovich, 14 Aberfeldie Street, Essendon	120.00	”	”
Alex Kechenovich, 14 Aberfeldie Street, Essendon	120.00	”	”
Mr Anthony John Keenan, 165 Argyle Street, Fitzroy	100.00	”	”
David Keet, 17 Unwin Crescent, Salter Point, WA	100.00	”	”
Bernard Keet, 17 Unwin Crescent, Salter Point, WA	100.00	”	”
Annette Keet, 17 Unwin Crescent, Salter Point, WA	100.00	”	”
Alan Keet, 17 Unwin Crescent, Salter Point, WA	100.00	”	”
Adrian Keet, 17 Unwin Crescent, Salter Point, WA	100.00	”	”
Emmanuel Steve Kefalas, 7 Inglewood Court, Gladstone Park	100.00	”	”
Erik Jan Keijzer, 41 King Street, Manly Vale, NSW	100.00	”	”
Jason Keir, 7 Stewart Place, Barrack Heights, NSW	100.00	”	”
Mr Craig Henry Keithley & Miss Jenneane Margaret Betts, 307 Oban Road, Ringwood North	100.00	”	”
Mr Rommel Kelaida & Mr Ronald Kelaida & Mr Raymond Kelaida, 12 Attunga Street, Chadstone	120.00	”	”
Kelanda Pty Ltd, “Lack Super Fund A/c”, 11 Studley Park Road, Kew	320.00	”	”
Cynthia Kelbourne, Lot 6 Redgum Place, Loomberah, NSW	140.00	”	”
Marjorie Kelbourne, Lot 6 Redgum Place, Loomberah, NSW	140.00	”	”
Geoffrey Dale Keleher, 11 Kingswood Drive, Dingley	100.00	”	”
Mr Denis Kelleher, 9 Kelvedon Avenue, Taroom, Tas.	100.00	”	”
David Paul Kelleher, PO Box 7, Mount Hawthorn, WA	100.00	”	”
Ms Linda Jane Kelly, 45 Lawndale Ave, North Rocks, NSW	100.00	”	”
Neil Edward Kelly, PO Box 58, Eidsvold, Qld	100.00	”	”
Susan Joy Kelly, PO Box 58, Eidsvold, Qld	100.00	”	”
Mr John Thomas Kelly & Mrs Jessie McKay Kelly, “Family A/c”, 13 Windsor Court, Warnambool	112.00	”	28/04/00
Mr John Thomas Kelly & Mrs Jessie McKay Kelly “Family A/c”, 13 Windsor Court, Warnambool	140.00	”	27/10/00
Kearin Kelly, PO Box 568, Kalgoorlie, WA	100.00	”	”
Michael Barry Kelly & Jeanen Maree Kelly, “Merrivale Exe A/c”, 111 Park Street, Moonee Ponds	104.00	”	28/04/00
Paul Kelly, 56 Bobbin Head Road, Turramurra, NSW	100.00	”	27/10/00
Richard Kelly, 5 Ellerslie Crescent, Taringa, Qld	120.00	”	”
Sue Kelly, 47 Coolawin Road, Northbridge, Nsw	480.00	”	28/04/00
Graham Kelly, 47 Coolawin Rd, Northbridge, NSW	480.00	”	”
Michael Barry Kelly & Jenene Maree Kelly, “Merrivale Exec S/F A/c”, PO Box 215, Essendon	136.00	”	”
Frances Louise Kelly, 32 McGregor Street, Nagambie	100.00	”	27/10/00
Gregg Kelly, 21 Wentworth Drive, Liberty Grove, NSW	164.25	”	28/04/00

Gregg Kelly, 21 Wentworth Drive, Liberty Grove, NSW	272.00	''	27/10/00
Kelmine Pty Ltd, 18 The Esplanade, Perth, WA	128.00	''	28/04/00
Kelmine Pty Ltd, 18 The Esplanade, Perth, WA	160.00	''	27/10/00
Mrs Emma Kemeny, "Michael Kemeny A/c", 81 Bulkara Road, Bellevue Hill, NSW	100.00	''	''
Mrs Emma Kemeny, "Sarah Kemeny A/c", 81 Bulkara Road, Bellevue Hill, NSW	100.00	''	''
Jim Kemister, PO Box 61, St Leonards, NSW	120.00	''	''
James Eric Kemp, C/- 19 Hunter Street, Euroa	120.00	''	''
Mrs Kim Kemp & Mrs Lynn Elaine Telfer, C/- 23 Hamilton Street, East Fremantle, WA	140.00	''	''
Kevin Jeffrey Kempin & Christa Kempin, 4 Sylvia Way, Eden Hill, WA	155.00	''	''
Ms Sallie Elizabeth Kendall, 11A Warringah Road, Mosman, NSW	230.40	''	28/04/00
Ms Sallie Elizabeth Kendall, 11A Warringah Road, Mosman, NSW	288.00	''	27/10/00
Ronald Hodges Kennedy, 4/38 Warrigal Road, Mentone	181.30	''	28/04/00
Ronald Hodges Kennedy, 4/38 Warrigal Road, Mentone	300.00	''	27/10/00
Andrea Robyn Kennedy & Simon James Uthmeyer, The Mandalay 23/18-20 The Esplanade, St Kilda	304.00	''	28/04/00
Andrea Robyn Kennedy & Simon James Uthmeyer, The Mandalay 23/18-20 The Esplanade, St Kilda	380.00	''	27/10/00
Belinda Kennedy, 349 Victoria Street, Abbotsford	256.00	''	28/04/00
Belinda Kennedy, 349 Victoria Street, Abbotsford	320.00	''	27/10/00
Mr Wayne Kennedy, 16 Whitworth Street, Geraldton, WA	100.00	''	''
Philip J. Kennedy, 24 Alfred Street, Rozelle, NSW	362.15	''	28/04/00
Philip J. Kennedy, 24 Alfred Street, Rozelle, NSW	600.00	''	27/10/00
Andrew J. Kennedy, 13 Rozells Avenue, Colonel Light Gardens, SA	220.00	''	''
Mr Robert William Kennedy, Oaklodge, 3 Oak Avenue, Surfers Paradise, Qld	161.60	''	28/04/00
Meredith Jayne Kenner, 16 Berkeley Court, Mount Eliza	112.00	''	''
Colin Michael Kennerley, 10 Doone Street, MacGregor, Qld	100.00	''	27/10/00
Vera Doreen Kent, 22 Rosebud Parade, Viewbank	100.00	''	''
Christopher John Keogh, 11/1064 Old Princes Highway, Engadine, NSW	112.00	''	28/04/00
Christopher John Keogh, 11/1064 Old Princes Highway, Engadine, NSW	140.00	''	27/10/00
Est Judith Elaine Kerdel, PO Box 204, Black Rock	112.00	''	28/04/00
Est Judith Elaine Kerdel, PO Box 204, Black Rock	140.00	''	27/10/00
Gysbertus Kerkhof, PO Box 6077, Karingal	100.00	''	''
Miss Janelle Ruth Kerkow, 13 Churchill St, Churchill, Qld	100.00	''	''
John Kermeen, 141 Hindmarsh Rd, Victor Harbour, SA	100.00	''	''
Ian Richard Kerr, 3a William Street, Epping, NSW	100.00	''	''
Mr Justin John Kerr, 329A Rainbow Street, Coogee, NSW	102.40	''	28/04/00
Mr Justin John Kerr, 329A Rainbow Street, Coogee, NSW	128.00	''	27/10/00
Belinda Kerr, Level 14, 20 Bond Street, Sydney, NSW	100.00	''	''
Kerwin Nominees Pty Ltd, "Derwin Williams Family A/c", C/- Dr D. R. Williams, 3 Rectory Walk, Springfield, Sa	100.00	''	''
Norman John Keshan, PO Box 1446, North Sydney, NSW	300.00	''	''
Michael Kessissoglou, 6/132 Mounts Bay Road, Perth, WA	160.00	''	28/04/00
Michael Kessissoglou, 6/132 Mounts Bay Road, Perth, WA	200.00	''	27/10/00

Simon P. Ketch, 2/6 Faulkner Street, Bentleigh	132.85	''	28/04/00
Simon P. Ketch, 2/6 Faulkner Street, Bentleigh	220.00	''	27/10/00
Edmond Keur, 265 The Boulevard, East Ivanhoe	217.20	''	28/04/00
Edmond Keur, 265 The Boulevard, East Ivanhoe	360.00	''	27/10/00
Edmond Jacobus J. L. Keur, 265 The Boulevard, East Ivanhoe	205.05	''	28/04/00
Edmond Jacobus J. L. Keur, 265 The Boulevard, East Ivanhoe	340.00	''	27/10/00
Rudolf Khaikin & Eva Gin, 10/18 Roselea Street, Caulfield South	120.00	''	''
Hamida Khan, Level 4, 469 Latrobe Street, Melbourne	100.00	''	''
Ayub Khan, 6/250 Collins Street, Melbourne	132.85	''	28/04/00
Ayub Khan, 6/250 Collins Street, Melbourne	220.00	''	27/10/00
Erica Khattar, 6 Parkham Road, Oatlands, NSW	120.00	''	''
Adam Kheireddine & Liana Kheireddine, "A. & L. Kheireddine A/c", 8/141 Oberon St, Coogee, NSW	100.00	''	''
Cecilia Khoo, Flat 2 24/F Block B, Kingsfield Tower, 64-68 Pokfulam Road, Hong Kong	100.00	''	''
Sheau Pau Khor, 35 Northcote Avenue, Balwyn	100.00	''	''
Joyce Sheau-Pau Khor, 35 Northcote Avenue, Balwyn	100.00	''	''
Dr Johannes Khiam-Lin Khor, Unit 2, 139 Glen Iris Road, Glen Iris	400.00	''	''
Mr Balose Khoshbakht, PO Box 5022, Mordialloc	210.00	''	''
Thi Kim Thuy Khuat, 1/55 Northumberland Road, Auburn, NSW	100.00	''	''
Duc Khiem Khuu & Lam-Chen Ung, 28 Kara Crescent, Para Hill, SA	200.10	''	28/04/00
Duc Khiem Khuu & Lam-Chen Ung, 28 Kara Crescent, Para Hill, SA	332.00	''	27/10/00
Bik Khuu, 8/83 Hughes Street, Cabramatta, NSW	344.00	''	''
Duc Khiem Khuu & Lam Chen Ung, "Khuu & Ung Super Fund A/c", 28 Kara Crescent, Para Hill, SA	181.30	''	28/04/00
Duc Khiem Khuu & Lam Chen Ung, "Khuu & Ung Super Fund A/c", 28 Kara Crescent, Para Hill, SA	300.00	''	27/10/00
Mrs Hien Uyen Khuu, 35 Quondong Avenue, Parafield Gardens, SA	100.00	''	''
Mr Khai Kien Khuu, 28 Kara Crescent, Kara Hills, SA	100.00	''	''
Mrs Hien Uyen Khuu. "Yao J. Ly A/c", 35 Quondong Avenue, Parafield Gardens, SA	100.00	''	''
Mrs Hian Uyen Khuu, "Hank J. Ly A/c", 35 Quondong Avenue, Parafield Gardens, SA	100.00	''	''
Mr Khiem Duc Khuu, 28 Kara Crescent, Para Hills, SA	100.00	''	''
Ms Hien Uyen Khuu & Mr Hav Ly, 35 Quondong Avenue, Parafield Gardens, SA	100.00	''	''
Chih Lin Kiang, 31 Frederick Street, Sydenham, NSW	118.40	''	28/04/00
Chih Lin Kiang, 31 Frederick Street, Sydenham, NSW	148.00	''	27/10/00
Wassil Kich & Maria Kich, 3 Willow Drive, Mossvale, NSW	200.00	''	''
Mr Wassil Bohdan Kich, 8 Emily Circuit, Bowral, NSW	100.00	''	''
Mrs Maria Kich, 8 Emily Circuit, Bowral, NSW	100.00	''	''
Miss Amy Claire Kich, 8 Emily Circuit, Bowral, NSW	100.00	''	''
Mr Wassil Bohdan Kich, "Adam Kich A/c", 8 Emily Circuit, Bowral, NSW	100.00	''	''

Kay Kiehle, PO Box 7231, East Brisbane, Qld	100.00	''	''
Glen Francis Kierge, "Kierse Family A/c", 83 The Boulevard, Ivanhoe	100.00	''	''
Killarney International Investments Limited, C/- Bell Securities Limited, Level 33, 225 George Street, Sydney, NSW	603.10	''	28/04/00
Paul Killeen, 40 Aldershot Drive, Keilor Downs	231.60	''	27/10/00
Peter A. Kilvert, 40 Bertram Street, Gardenvale	120.70	''	28/04/00
Peter A. Kilvert, 40 Bertram Street, Gardenvale	200.00	''	27/10/00
Yae Jin Kim & Christopher Hyoung Jin Kim, Unit P4, 38 Victoria Street, Epping, NSW	198.40	''	28/04/00
Ms Beverly Anne Kimmorley, 42 Schonell Circuit, Oxley, ACT	100.00	''	27/10/00
Mr David Kimmorley, 42 Schonell Circuit, Oxley, ACT	140.00	''	''
Peter Rodney Kimpton, RMB 1010, Glenoak Mail, Wagga, NSW	100.00	''	''
Kindicorp Pty Ltd, 19 Orinoco Street, Pymble, NSW	140.00	''	28/04/00
Kindicorp Pty Ltd, 19 Orinoco Street, Pymble, NSW	232.00	''	27/10/00
Kenneth Michael Kinealy, 1 Chisholm Avenue, Clareville, NSW	360.00	''	''
Michael King & Greg Stephens & Bruce Levy, "Luft Australia Super A/C", 140 Mont Albert Road, Canterbury	800.00	''	''
Samuel Charles King, 37 Airlie Street, South Yarra	240.00	''	28/04/00
Louis Evans King, 4 Follett Street, Torquay	100.00	''	27/10/00
King York Investments Pty Ltd, PO Box S32, Broadway, NSW	100.00	''	''
Simone Gwendoline Kinghorn, 2/7 Quarry Street, Hamilton, Qld	130.00	''	''
Mr Maxwell Howard Kingston, Unit 10, 6 Mortimer Lewis Drive, Huntleys Cove, Tarban, NSW	140.00	''	''
Tanya Kirchner & Bruce Kirchner, 48 Clyde Rd, Hurston, Qld	168.00	''	28/04/00
Tanya Kirchner & Bruce Kirchner, 48 Clyde Rd, Hurston, Qld	210.00	''	27/10/00
Mrs Margaret M. Kirkman, 41 Ben Boyd Road, Neutral Bay, NSW	160.00	''	28/04/00
Mrs Margaret M. Kirkman, 41 Ben Boyd Road, Neutral Bay, NSW	200.00	''	27/10/00
Helen Kirkman, "Kirkman Family A/c", 59 Cormiston Rd, Riverside, Tas.	100.00	''	''
Kis Pty Ltd, 27 Swinton Avenue, Kew	100.00	''	''
James Lewis Kissick, PO Box 32, Curlwaa, NSW	120.00	''	''
Tomoko Kitano, PO Box U180, University of Wollongong, Wollongong, NSW	208.00	''	28/04/00
Tomoko Kitano, PO Box U180, University of Wollongong, Wollongong, NSW	260.00	''	27/10/00
Mr Paul John Kitson, 307 Seaview Rd, Henley Beach, SA	100.00	''	''
Kiverdale Pty Ltd, 3 Coleman Court, North Dandenong	100.00	''	''
David Norman Kleeman & Jacqueline Kleeman, 13 Burton Road, Lilydale	100.00	''	''
Mark Klein, 1/32 Ocean Street, Bondi, NSW	100.00	''	''
Ms Louise Klein, 39 Haines Street, Hawthorn	100.00	''	''
Katherine Marie Klinger, 70 Waterview St, Balmain, NSW	100.00	''	''
Rosa Klinger, 146 Wycomba Rd, Neutra Bay, NSW	280.00	''	''

Rebecca Agnes Knapp, 3/44 Hyland Street, Warrnambool	100.00	''	''
Margaret Knazko, 112 Bridge Road, Glebe, NSW	448.00	''	28/04/00
Christopher Knight, 28 Oakover Street, East Fremantle, WA	100.00	''	27/10/00
Julie Knight, 10/108 Reserve Road, Artarmon, NSW	100.00	''	''
Lorraine Dawn Knight, 2/21 Hatton Court, Bassendean, WA	100.00	''	''
Knight Computing Services "Super Fund A/c", 21 Waratatah Street, Harbord, NSW	100.00	''	''
Henry Knott, "Korty Family A/c", 47 Carr Street, Waverton, NSW	135.85	''	28/04/00
Henry Knott, "Korty Family A/c", 47 Carr Street, Waverton, NSW	225.00	''	27/10/00
Mr Steven Knowles, 3 Cintra Avenue, St Kilda	100.00	''	''
R. K. Knox & G. F. Knox, "C, & T, & K, Knox A/c", 16 Ardwick Street, Moorabbin	120.00	''	''
Jeanette Marie Knox, 74A Louisa Road, Birchgrove, NSW	100.00	''	''
Mr Greg Knox, Unit 5, 20 Durham Street, St Lucia, Qld	166.60	''	''
Suzanne Gaye Knox, 3 Ridgeway Avenue, Kew	288.00	''	28/04/00
Suzanne Gaye Knox, 3 Ridgeway Avenue, Kew	360.00	''	27/10/00
Ms Fiona Knox, 9 Singleton Road, Balwyn North	120.00	''	28/04/00
Ms Jacqueline Knox, Unit 11/30 Park Drive, Parkville	112.00	''	27/10/00
Allan Ko & Emily Ko, PO Box 5086, Kenmore, Qld	205.05	''	28/04/00
Allan Ko & Emily Ko, PO Box 5086, Kenmore, Qld	340.00	''	27/10/00
Est Boon Chen Ko, C/- Libman Davis & Associates, PO Box 272, Balwyn	250.00	''	''
Ms Lauretta Koch, "Roger Koch Super Fund A/c", Unit 6, 694 Riversdale Road, Camberwell	336.00	''	28/04/00
Ms Lauretta Koch, "Roger Koch Super Fund A/c", Unit 6, 694 Riversdale Road, Camberwell	420.00	''	27/10/00
Jury Kogan, 1/209 Bamba Road, Caulfield South	112.88	''	28/04/00
Jury Kogan, 1/209 Bamba Road, Caulfield South	186.60	''	27/10/00
Olga Kohut, U2/18 Wheatley Rd, Bentleigh	120.00	''	''
Mirella Koleszko, 4/145 Marmion Street, Fremantle, WA	100.00	''	''
Kon Klados & Associates Pty Limited, "The Klados Super Fund A/C", 11 Huskisson Avenue, Lalor	290.00	''	''
Soon Sim Kong, 446 Avoca Street, Kingsford, NSW	100.00	''	''
Fui Lip Kong & Wendy Khi Tshing Kong, 42/1-9 Yardley Avenue, Waitara, NSW	160.00	''	28/04/00
Fui Lip Kong & Wendy Khi Tshing Kong, 42/1-9 Yardley Avenue, Waitara, NSW	200.00	''	27/10/00
Kontaz Projects Pty Ltd, 7 McColl Road, Box Hill North	140.00	''	''
Auli Kontkanen, 4/498 Bourke Street, Surry Hills, NSW	140.00	''	''
Mr James Tam Chao Koo, 23 Beahan Place, Cherrybrook, NSW	400.00	''	''
Mr James Koo, 23 Beahan Place, Cherrybrook, NSW	100.00	''	''
Charan Singh Kooner & Kirpal Kaur Kooner & Rajdeep Singh Kooner, 21 Matong Place, Gympie Bay, NSW	360.00	''	''
Siew Mam Koot, 10 Holway Street, Eastwood, NSW	100.00	''	''
Judith Clare Kor, 30 Garling Street, Lane Cove, NSW	100.00	''	''
Spiridoula Kordas, 72 Abinger Street, Richmond	288.00	''	28/04/00
Tobi Kornwasser, 24 Talbot Ave, St Kilda East	100.00	''	27/10/00
Leslie Kornwasser, "Zev Aryeh Kornwasser A/c", 24 Talbot Avenue, St Kilda East	130.00	''	''
Mr Frank Paul Kosik, 26 Ievers Street, Parkville	300.00	''	''

George Kosmakos, 2 Walsh Street, Broadmeadows	100.00	''	''
Anthony Leo Kost, 157 Mountain View Road, Briar Hill	160.00	''	28/04/00
Zarija Kostovski, "Bianca Kostovski A/c", 3 Maywood Drive, Epping	130.00	''	27/10/00
Shantilal Narandas Kotecha, 42 Goodwyn Road, Berowra, NSW	210.00	''	''
Mary Elizabeth Koth & Bruce Eric Koth, PO Box 1030, Tamworth, NSW	100.00	''	''
Bun-Ho Kouch, 238 St Johns Road, St Johns Park, NSW	176.00	''	28/04/00
Bun-Ho Kouch, 238 St Johns Road, St Johns Park, NSW	220.00	''	27/10/00
Dimosthenis Kourlas & Stratoula Kourlas, PO Box 283, Loxton, SA	120.00	''	''
Mr Constantinos Kourtis, 275 Mahoneys Road, East Burwood	120.70	''	28/04/00
Mr Constantinos Kourtis, 275 Mahoneys Road, East Burwood	100.00	''	27/10/00
Konstantina Koutropoulos, 104 Wright Street, Middle Park	260.00	''	''
Ms Konstantina Koutropoulos & Ms Fotina Koutropoulos, 104 Wright Street, Middle Park	150.00	''	''
Philomel Koutsoubou, 72 Freya St, Karella, NSW	177.60	''	28/04/00
George Koutsouridis & Elizabeth Koutsouridis, 2 Carlson Drive, North Haven, SA	100.00	''	27/10/00
Kaz Kowaleczko & Irena Kowaleczko, 41 Anderson Rd, Kings Langley, NSW	120.70	''	28/04/00
Kaz Kowaleczko & Irena Kowaleczko, 41 Anderson Rd, Kings Langley, NSW	200.00	''	27/10/00
Ron Kramer, "Benjamin Kramer A/c", 45 Beresford Road, Rose Bay, NSW	100.00	''	''
Leo Krashias & Maria Krashias, 40 Avalon Parade, Avalon Beach, NSW	120.00	''	''
Rick Ashley Kreeck, 25/9-19 Miller Street, Fitzroy North	100.00	''	''
Ms Kathleen Kreig, 11 Westwood Avenue, Belmore, NSW	100.00	''	''
Mr Thomas Neville Kreig, 11 Westwood Avenue, Belmore, NSW	120.00	''	''
Scott Vaclav Krejzlik, Unit 8, 15 Queens Avenue, Parramatta, NSW	128.00	''	28/04/00
Scott Vaclav Krejzlik, Unit 8, 15 Queens Avenue, Parramatta, NSW	160.00	''	27/10/00
Michael Kretschmer, 28 Wilton Cres, Wheelers Hill	125.65	''	28/04/00
Kristim Nominees Pty Ltd, "Superannuation A/c", 71 Douglas Street, Stanmore, NSW	301.55	''	''
Peter Kronborg & Leonie Kronborg, 38 Carlington Street, Canterbury	160.00	''	''
Peter Kronborg & Leonie Kronborg, 38 Carlington Street, Canterbury	200.00	''	27/10/00
Noel Francis Kropp & Pamela Joy Kropp, "Kropp Retirement S/F A/c", PO Box 464, Kew	243.00	''	''
Mr Paul James Krueger, 18 Dalrello Street, Carina, Qld	100.00	''	''
Leanne Kruss, "Truss Children Family A/c", 1/1 Moignard Street, Manooora, Qld	120.00	''	''
Mrs Eleonore Kueshall, 39 Dulkara Road, Ingle Farm, SA	160.00	''	''
Mss Thu Kuhat, "Nguyen Khuu A/c", 1/55 Northumberland Street, Auburn, NSW	100.00	''	''
Mrs Jawdokia Kuhlmann, C/- Mrs V Clarke, 1/2 Bradford Avenue, Kew	600.00	''	28/04/00

Mrs Jawdokia Kuhlmann, C/- Mrs V Clarke, 1 / 2 Bradford Avenue, Kew	750.00	''	27/10/00
Sachin Suresh Kumar, 10/14 Park Avenue, Burwood, NSW	105.00	''	''
Goran Kuna, 32 Turner Street, Pascoe Vale South	100.00	''	''
Leisa Mei Hui Kuo, 98 Menser Street, Clamvale, Qld	100.00	''	''
Mr Jung-Hsin Kuo, 42 Nicholson Street, Chatswood, NSW	250.00	''	''
Prince Kavantissa Kuruppu, 15 Lotus Crescent, Mulgrave	100.00	''	''
Renee Kuzl & Nachum Baihelfer, 104 Tucker Road, East Bentleigh	100.00	''	''
Mr Seng Choon Kwa, 5 Betchel Court, Rivervale, WA	140.00	''	''
Deborah Louise Kydd, 68 Electra Street, Williamstown	120.70	''	28/04/00
Deborah Louise Kydd, 68 Electra Street, Williamstown	200.00	''	27/10/00
L. & D. Secretarial Services Pty Ltd, "Super Fund A/c", PO Box 45, Ringwood East	100.00	''	''
L. & M. Doupe P/L, S/Fund A/c, 963 Doncaster Road, East Doncaster	100.00	''	''
L. J. Nicolas Nominees Pty Ltd, 12 Desaumarez, Kensington Park, SA	248.00	''	''
Stephen F. Labady & Joan M Labady, PO Box 317, Bentleigh East	100.00	''	''
Labour Hire Pty Ltd, 108 Sydney Road, Coburg	108.00	''	''
Mr Lucien Edouard Lagrange, "Alastair M. Lagrange A/c", 105 Heytesbury Road, Subiaco, WA	100.00	''	''
Mr Lucien Edouard Lagrange, "Annabel Jane Lagrange A/c", 105 Heytesbury Road, Subiaco, WA	100.00	''	''
Mr Lucien Edouard Lagrange, "Claudia M. Lagrange A/c", 105 Heytesbury Road, Subiaco, WA	100.00	''	''
Mr Stanley Wai Hung Lah, Floor 32, Flat F, Block 2, Le Sommet, 28 Fortress Hill Road, North Point	900.00	''	''
Gang Lai & Bei Cai, 21/9 Burley Street, Lane Cove, NSW	160.00	''	28/04/00
Dianne Victoria Lakshmanan, 28 Newton Road, Strathfield, NSW	100.00	''	27/10/00
Bill Lam, 15 Arden Street, North Melbourne	158.20	''	28/04/00
Laurene Lam, 15/391 Mowbray Road, Chatswood, NSW	138.90	''	''
Mrs Pauline Lam, GPO Box 929, Sydney, NSW	100.00	''	27/10/00
Mr Wah Lam, 18 Park Hill Way, Doncaster	100.00	''	''
Mr Ming Hei Lam & Ms Pui Shan Yan, 12 Bass Street, Box Hill	138.90	''	28/04/00
Gary Ross Lamb, 5827 Wolseley Avenue, Cote St Luc, Quebec, Canada H4W 219	100.00	''	27/10/00
Peter Henry Lamb, Unit 2/19 Porter St, Kalgoorlie, WA	100.00	''	''
Ruchi Lamba, 6/24 Ethel Street, Eastwood, NSW	100.00	''	''
Ms Deborah Michelle Lamicela, 177 The Avenue, Coburg	271.75	''	28/04/00
Ms Deborah Michelle Lamicela, 177 The Avenue, Coburg	300.00	''	27/10/00
Leona Lamovie, 7/1 Brookville Road, Toorak	160.00	''	28/04/00
Leona Lamovie, 7/1 Brookville Road, Toorak	200.00	''	27/10/00
Christopher James Lancaster, "Benjamin Lancaster A/c", 9 Ferncliffe Road, Glenhaven, NSW	120.00	''	''
Mr Peter Jesse Landon, "The Augusta S/F A/c", 28 Boondooma Circuit, Albany Creek, Qld	100.00	''	''
Susan Mary Landy, 1/521 Toorak Road, Toorak	640.00	''	28/04/00
Susan Mary Landy, 1/521 Toorak Road, Toorak	800.00	''	27/10/00
David Griffith Lang, Po Box Z5225, Perth, WA	112.00	''	''

Mr David John Lang & Ms Lin Asher Walden, "Janet M B Lang A/c", PO Box 388, Bentleigh East	140.00	"	"
Robert William Lang, 2/27 Seaside Avenue, Mermaid Beach, Qld	120.70	"	28/04/00
Robert William Lang, 2/27 Seaside Avenue, Mermaid Beach, Qld	200.00	"	27/10/00
Ann Lang, 2/27 Seaside Avenue, Mermaid Beach, Qld	120.70	"	28/04/00
Ann Lang, 2/27 Seaside Avenue, Mermaid Beach, Qld	200.00	"	27/10/00
Robert Langer & Elizabeth Langer, PO Box 68, Burwood	200.00	"	"
Mr Peter Evan Langfelder, 19 A Maud St, Balwyn North	220.00	"	"
John Langford, "The Hilliard Super Fund A/c", 37 Mortimer Avenue, Mount Stuart, Tas.	300.00	"	"
Kerry Langley, 5 Byrne Crescent, Maroubra, NSW	128.00	"	28/04/00
Kerry Langley, 5 Byrne Crescent, Maroubra, NSW	160.00	"	27/10/00
Kenneth Robert Langley & Wendy Jean Langley, 12 Davenport Terrace, Wayville, SA	100.00	"	"
Mark Gordon Langsworth, 48 Barwon Avenue, Turrumurra, NSW	100.00	"	"
Langwarrin Hotel Pty Ltd, "Langwarrin Hotel Super A/c", 220 Cranbourne Road, Langwarrin	300.00	"	"
Charles Lankester Junior, 12 Faulkner Street, Wembley Downs, WA	160.00	"	28/04/00
Charles Lankester Junior, 12 Faulkner Street, Wembley Downs, WA	200.00	"	27/10/00
William John Lannan, 104 Mons Avenue, Maroubra, NSW	100.00	"	"
Helene May Lannan, 104 Mons Avenue, Maroubra, NSW	100.00	"	"
Lantalia Pty Limited, "The Edwards Super Fund A/C", 40 Andrews Street, Capalaba, Qld	120.00	"	"
Mario Lanza, "Onofrio Lanza A/c", 36 Parker Street, Lower Templestowe,	120.00	"	"
Roald Larsen, 56 The Outlook, Bilgola Plateau, NSW	210.00	"	"
Fae Larsen, 56 The Outlook, Bilgola Plateau, NSW	210.00	"	"
Fae Larsen & Roald Larsen, "Bjorn Larsen A/c", 56 The Outlook, Bilgola Plateau, NSW	150.00	"	"
Fae Larsen & Roald Larsen, "Tenar Larsen A/c", 56 The Outlook, Bilgola Plateau, NSW	150.00	"	"
Fae Larsen & Roald Larsen, "Michael Steven Larsen A/c", 56 The Outlook, Bilgola Plateau, NSW	150.00	"	"
Roald Larsen & Fae Larsen, "Sara-Late Larsen A/c", 56 The Outlook, Bilgola Plateau, NSW	150.00	"	"
Costas Nikolas Laskaris & Elizabeth Jane Laskaris, Barwon Avenue, South Turrumurra, NSW	100.00	"	"
Lasomount Pty Ltd, 91 Dover Road, Dover Heights, NSW	100.00	"	"
Anastasios Laspas & Catherine Laspas, 6 Westbrook Street, Chadstone	100.00	"	"
Amy Lasscock, 5 Annells Ct, Grange, SA	110.00	"	"
Garth Delon Lategan, 8 Walter Street, South Yarra	144.00	"	28/04/00
Zbig Charles Laube, 12 Shellbank Parade, Cremorne, NSW	160.00	"	"
Sally Laue, 19 Dartford Road, Thornleigh, NSW	100.00	"	27/10/00
Morris Paul Lauga, 115 Magee Street, North Rockhampton, Qld	100.00	"	"
Ross Douglas Laurence, 107/185 Elizabeth Street, Sydney, NSW	150.00	"	"

Ross Laurence, 107/185 Elizabeth Street, Sydney, NSW	150.00	''	''
Miss Joanna Poi Laurie, PO Box 62, Riddells Creek	249.60	''	28/04/00
Mr Paul Lavelle, 202 Barkly Street, St Kilda	120.00	''	27/10/00
Harold Laver, "Shaun Michael Laver Account", 10 Hayes Street, Bentleigh	100.00	''	''
Laverton Engineering & Manufacturing Pty Ltd, 79 Welwyn Parade, Deer Park	100.00	''	''
Martin Law, 11 Pindrie Place, Belrose, NSW	100.00	''	''
Hock Ching Law, PO Box 168, Moonee Ponds	100.00	''	''
Mr David Stuart Law, "Dunbar A/c", Box 1003, Nedlands, WA	110.00	''	''
Estate Clement Elliott Lawford, PO Box 498, Hamilton Central, Qld	937.60	''	28/04/00
Adam David Lawler & Angela Lawler, 411 Learmonth Street, Buninyong	130.00	''	27/10/00
Karen Michelle Lawler, 6/49 Kirkham Hill Terrace, Maylands, WA	100.00	''	''
William Cabled Lawrance, RMB 7193, Esperance, WA	160.00	''	''
Robin Lawrence, 9 Kylie Street, Sunnybank, Qld	160.00	''	''
Mrs Rosemary Lawrence, 43B Adams St, Curl Curl, NSW	100.00	''	''
James Anthony Lawrence & Peter James Lawrence, 529 Cudgen Road, Cudgen, NSW	100.00	''	''
Mr Antony Marc Lawrence, 10 Stevens Place, Kardinya, WA	193.00	''	''
Susan Mary Lawson, 39 Rothesay Avenue, East Malvern	100.00	''	''
Fa Lim Lay, 18 Kurtz Street, Toowoomba, Qld	240.00	''	28/04/00
Sin Hau Lay & Ki Hau Lay & Xiao Hong Lay, 8/59 Garfield Street, Five Dock, NSW	180.00	''	27/10/00
Peter Lay, 182 Franklin Street, Sydney, NSW	100.00	''	''
David Layton, "Layton Family A/c", 3/102 Carrington Road, Waverley, NSW	120.70	''	28/04/00
David Layton, "Layton Family A/c", 3/102 Carrington Rd, Waverley, NSW	200.00	''	27/10/00
Con Lazaris, 17 Bayliss Street, Preston	200.00	''	''
Mr Glen Lazarus, 11 Merton Street, Ivanhoe	132.50	''	''
Robert William Lazell, 2/9 Parkview Close, Dandenong	100.00	''	''
Robert Secundo Lazzarini, PO Box 831, Strawberry Hills, NSW	100.00	''	''
Ms Wendy Lazzarini, 4 Kruse Place, The Gap, Qld	262.00	''	''
LCMS Australia Pty Limited, "Skilleter Family A/c", PO Box 762, Castle Hill, NSW	100.00	''	''
Brian Le Leu, 21 Stuckey Ave, Underdale, SA	132.85	''	28/04/00
Brian Le Leu, 21 Stuckey Ave, Underdale, SA	220.00	''	27/10/00
Ian Joseph Le Nepveu, 474 Bridge Road, Richmond	100.00	''	''
Elizabeth B Le Page, 48 Dunloe Avenue, Box Hill North	100.00	''	''
Paul Lea, 6 Soper Drive, North Nowra, NSW	100.00	''	''
Noel Thomas Leach & Margaret Anne Leach, PO Box 19, Penshurst, NSW	160.00	''	28/04/00
Noel Thomas Leach & Margaret Anne Leach, PO Box 19, Penshurst, NSW	200.00	''	27/10/00
Leo Leader, 52 Cliff Avenue, Northbridge, NSW	100.00	''	''
Brian Anthony Leahy & Dorothy Margaret Leahy, "Leahy Super Fund A/c", Post Office, Garboc	192.00	''	28/04/00
Dimitria Lear, 31/26 Cranbrooke Avenue, Cremorne, NSW	200.00	''	27/10/00

St Dimitria Lear, 31/26 Cranbrooke Ave, Cremorne, NSW	100.00	''	''
Mr James Edwin John Leary, 2715 MacPherson Street, Waverley, NSW	149.00	''	''
Leck Logic Pty Ltd, C/- Nigel Leck, 12 Beconsfield Street, Newport, NSW	200.00	''	''
Mr Derek Leddie, 30 Burton Street, East Sydney, NSW	120.00	''	''
John Lee & Penelope Lee, 200 Young St, Annandale, NSW	200.00	''	''
Amanda Lee, 6 Warrego Ave, Sylvania Waters, Nsw	100.00	''	''
You-Ok Lee & Kyu-Shik Lee, 62 McIntyre Street, Gordon, NSW	120.00	''	''
Doris Lee, 6 Warrego Avenue, Sylvania Waters, NSW	100.00	''	''
Kai-Ming Lee, 9/57 Brisbane Street, St Lucia, Qld	100.00	''	''
Kenneth Lee, 6 Warrego Avenue, Sylvania Waters, NSW	220.00	''	''
Eva Waiman Lee, 42 Forest Way, Frenchs Forest, NSW	127.90	''	28/04/00
Eva Waiman Lee, 42 Forest Way, Frenchs Forest, NSW	212.00	''	27/10/00
Adam Lee & Anny Lee, 21 Avanti St, Mermaid Waters, Qld	182.40	''	28/04/00
Adam Lee & Anny Lee, 21 Avanti St, Mermaid Waters, Qld	228.00	''	27/10/00
Mei Lin Lee, 22 Cordeaux Crescent, Sylvania Waters, NSW	100.00	''	''
Wai Ying Lee, 61 Myall Street, Concord West, NSW	150.00	''	''
Christopher Milman Lee, 27 Palmer Street, Portland	256.00	''	28/04/00
Christopher Milman Lee, 27 Palmer Street, Portland	320.00	''	27/10/00
Foo Y. Lee, 9 Wisteria Court, Clarinda	400.00	''	28/04/00
Mr Andrew Lee, 10 Daffodil Street, Eastwood, NSW	663.20	''	''
Mrs Eva Birgitta Lee, GPO Box 2755, Sydney, NSW	100.00	''	27/10/00
Mr David Lee, Lot 100, Oakley Road, Long Point, NSW	240.00	''	28/04/00
Mr David Lee, Lot 100, Oakley Road, Long Point, NSW	300.00	''	27/10/00
Mr Phil Lee, 78/3 Williams Parade, Dulwich Hill, NSW	150.00	''	''
Mr John Lee, Unit 16, 49 Albert Road, Strathfield, NSW	200.00	''	''
Edgar Leech, 3 Kallaroo Street, Corlette, NSW	128.00	''	28/04/00
Edgar Leech, 3 Kallaroo Street, Corlette, NSW	160.00	''	27/10/00
Brian Lees, 9 Morgan Avenue, Croydon	200.00	''	28/04/00
Brian Lees, 9 Morgan Avenue, Croydon	250.00	''	27/10/00
Rith Lees, 9 Morgan Avenue, Croydon	200.00	''	28/04/00
Rith Lees, 9 Morgan Avenue, Croydon	250.00	''	27/10/00
Christine Lefevre-Smith & Jim Smith, "Springmount Ponds S/F A/C", 30 Lyons Road, Drummoyne, NSW	100.00	''	''
Margaret Anne Legge, 3A Lambert Road, Toorak	151.00	''	28/04/00
Margaret Anne Legge, 3A Lambert Road, Toorak	250.00	''	27/10/00
Sam Jonathan Lehman, PO Box 170, Fullarton, SA	265.00	''	''
Ian Leitch, 25 Rivers Street, Weston, ACT	169.60	''	28/04/00
Ian Leitch, 25 Rivers Street, Weston, ACT	212.00	''	27/10/00
Lena Lejmanoski, 111 Royal Street, Tuart Hill, WA	120.00	''	''
Mr John R. Lemiere, 63 Landcox Street, Brighton East	176.00	''	28/04/00
John Frances Lenarcic, PO Box 838, Noble Park	100.00	''	27/10/00
Jacobus Lengkeek & Tania Lengkeek, 56 Smith Street, Dianella, WA	200.00	''	''
Christine Lennon, 15 Cronulla Avenue, Mermaid Beach, Qld	300.00	''	''
Robert Matthew Lenon, Rmb 1006a, Mooroopna	100.00	''	''
Lenport Pty Ltd, 19 Martin Place, Sydney, NSW	260.00	''	''
Mr Jean-Pierre Leonard, 10/2 Kettle Street, Redfern, NSW	177.60	''	''
Marzio Leone, "D & A Leone A/C", 24 Tesron Court, Werribee	100.00	''	''

Ng Kan Leong, 42 Meadowland Road, Peakhurst, NSW	320.00	''	''
Susan May Leong, 10 Storey Street, Maroubra, NSW	100.00	''	''
Hooi Heng Leong, 42 Meadowland Road, Peakhurst, NSW	200.00	''	''
Kok Yin Leong & Angelita Cornelia Leong, 1 Bluewater Court, Balnarring	100.00	''	''
Lescarcot Pty Ltd, 45 Ballast Point Road, Birchgrove, NSW	390.40	''	28/04/00
Lescarcot Pty Ltd, 45 Ballast Point Road, Birchgrove, NSW	488.00	''	27/10/00
Leslie W. K. Gan Ltd, "Super Fund A/c", 2 Palana Road, City Beach, WA	100.00	''	''
Leslie Wee Kee Gan Pty Ltd, "Super Fund A/c", 2 Palana Road, City Beach, WA	100.00	''	''
Mr Shane Gordon Stewart Lester, 202 Australia Street, Newtown, NSW	160.00	''	''
Mr Philip Baron Lethbridge & Mr Bruce Ronald MacPherson & Mr Peter Anthony McGowan, Bingara, Daysdale, NSW	112.00	''	28/04/00
Mr Philip Baron Lethbridge & Mr Bruce Ronald MacPherson & Mr Peter Anthony McGowan, Bingara, Daysdale, NSW	140.00	''	27/10/00
Michael Letts, 70 Jacka Crescent, Campbell, ACT	115.00	''	''
Pak Leung, 11/639 Princes Highway, Rockdale, NSW	155.00	''	''
Donald Leung, PO Box 522, Balwyn North	100.00	''	''
Anna Leung, PO Box 522, Balwyn North	100.00	''	''
Cecilia Leung & Daniel Leung, 18/18 Northcote Street, St Leonards, NSW	104.00	''	''
Rene Leuu, 75 South Valley Road, Park Orchards	100.00	''	''
Level Pty Ltd, 29 Strickland Road, Ardross, WA	1,084.80	''	28/04/00
Level Pty Ltd, 29 Strickland Road, Ardross, WA	1,356.00	''	27/10/00
James Howard Leven, 272 Dryandra St, Lyneham, ACT	108.00	''	''
William Hendrik Lever, 3 Peace Crescent, Balgownie, NSW	120.70	''	28/04/00
William Hendrik Lever, 3 Peace Crescent, Balgownie, NSW	200.00	''	27/10/00
Renee Michelle Lever, 3 Peace Crescent, Balgownie, NSW	120.70	''	28/04/00
Renee Michelle Lever, 3 Peace Crescent, Balgownie, NSW	200.00	''	27/10/00
Clasina Hendricka Lever, 227 Farnborough Road, Farnborough Heights, NSW	120.70	''	28/04/00
Clasina Hendricka Lever, 227 Farnborough Road, Farnborough Heights, NSW	200.00	''	27/10/00
Elize Mai-Lai Lew, 112 Murrumbeena Road, Murrumbeena	120.00	''	''
Andrew Lew, 12 Narrabri Court, Wheelers Hill	140.00	''	''
Mr Andrew Lew, 12 Narrabri Court, Wheelers Hill	200.00	''	''
Mr Roger A. Lewis, 14 Kaolin Court, Blackburn North	585.00	''	''
Ms June Margaret Lewis, 14 Kaolin Court, Blackburn North	385.00	''	''
David John Lewis, 49 Glenaro Drive, Eaglemont	210.00	''	''
Nigel Lewis, PO Box 518, Hawthorn	100.00	''	''
Mr Richard Lewis, Calool, Monto, Qld	100.00	''	''
Adam Gordon Lewis, 7 Eastbourne Way, Bella Vista, NSW	100.00	''	''
Mr James Gregory Lewis, PO Box 6401, Upper Mount Gravatt, Qld	210.00	''	''
Christiane Friedhilde Ley, 45 Church Street, Ashfield, NSW	100.00	''	''
Mr Patrick Ley, 68 Highgate Street, Strathfield, NSW	100.00	''	''
Mr Julian Ley, 68 Highgate Street, Strathfield, NSW	100.00	''	''
John Francis Ley & Julie Ley, 49 Tanumbirini Street, Hawker, ACT	102.00	''	''

Julie Ley, 49 Tanumbirini Street, Hawker, ACT	102.00	''	''
Leyshir Pty Ltd, Box 3041, Dendy Post Office, Brighton	200.00	''	''
Rui Lian Li, PO Box 256, Botany, NSW	257.00	''	''
Mr Yong Heng Li, 500 Racecourse Road, Flemington	450.00	''	''
Mr Hoi Hung Li & Mrs Shuk Man Li, 7 Hay Court, Doncaster East	150.00		''
Lai Young Li, PO Box 482, Bentleigh	140.00	''	''
Mr Henry Li, 2 Edith Street, Hurstville, NSW	100.00	''	''
Mr Bai Ying Li, No 12, 197 Lane Fu Ming Road, Shanghai, China	100.00	''	''
Ms Hui-Jun Li & Mr Zhao-Yu Zhu, 11 Kamarooka Avenue, West Pennant HILLS, NSW	110.00	''	''
Ms Huiying Li, Unit 52, 1 Katherine Street, Chatswood, NSW	200.00	''	''
Keith Lia, 18 Saint Hellier Street, Heidelberg Heights	100.00	''	''
Dr Douglas Liao, "Superannuation Fund A/c", Woodcroft Family Practice, Shop 1, Woodcroft Plaza, Doonside, NSW	200.00	''	''
Carlo Licciardi, C. & L. Family S. Annuation A/c, 126 Charles Street, Northcote	160.00	''	''
Lidelle Pty Ltd, "The Delloro U Nit A/c", PO Box 766, Brunswick Lower	112.00	''	28/04/00
Mim Jum Lie, PO Box 738, Templestowe	120.00	''	''
Mim Jum Lie, PO Box 738, Templestowe	150.00	''	27/10/00
Miss Caroline Liew, 15 Crampton Cresnet, Rosanna	100.00	''	''
Jack Lihou & Shirley May Lihou, 190 North Road, Brighton, Qld	100.00	''	''
Peter Likoudis, 59 Juliett Street, Marrickville, NSW	202.00	''	''
Ms Anne Marie Lilburne, 1 Boreham Street, Cottesloe, WA	140.00	''	''
Mr Andrew Lill, 9 Kileys Run, Clifton Grove, Orange, NSW	100.00	''	''
Danny Chee Meng Lim, 48B Cale Street, Como, WA	288.00	''	28/04/00
Swee Hong Lim, 16/213 Blackburn Road, East Doncaster	120.00	''	27/10/00
Jessica Lim, 36 Harry Street, South Yarra	100.00	''	''
Siew Hoon Lim, PO Box 289, Beecroft, NSW	362.15	''	28/04/00
Mr John Lim, 8 Telopea Court, Oakleigh South	200.00	''	27/10/00
Miss Joanne Lim, 18 Huxley Crescent, Endeavour Hills	170.00	''	''
Miss Yoke Wan Lim, 50 Bayshore Road, #03-08 Bayshore Park, Aquamarine Tower, Singapore 460977	147.80	''	28/04/00
Limex International Pty Ltd, 18 Huxley Crescent, Endeavour Hills	160.00	''	27/10/00
Yu Sen Lin, 5/70 Colin Street, Lakemba, NSW	224.00	''	28/04/00
Yu Sen Lin, 5/70 Colin Street, Lakemba, NSW	280.00	''	27/10/00
Mei-Ying Lin, Unit 9, 27 Merlin Street, Neutral Bay, NSW	120.00	''	''
Li-Hua Gu Lin, "Eric Bei-Chang Gu A/c", 143 Bleasby Road, Eight Mile Plains, Qld	120.00	''	''
Mr Shou-Jen Lin, 9F 280 Sec 1, Ho-Ping E Road. Taipei Taiwan	739.00	''	28/04/00
Linda Stone Investments Ltd, "Super Fund A/c", 153 Hutt Street, Adelaide, SA	300.00	''	27/10/00
Chong Gee, Olga Lindal, 105A Tennyson Road, Gladesville, NSW	100.00	''	''
Ms Anne Marie Lindesay, 9 Maleleuca St, Sunnybank, Qld	600.00	''	''
Jeffrey J. Lines, 8 Avon Close, Hillsborough, NSW	100.00	''	''
Chee Fung Ling, 81 Kent Street, Epping, NSW	192.00	''	28/04/00

Chee Fung Ling, 81 Kent Street, Epping, NSW	240.00	''	27/10/00
Li-Kiong Ling, 25 Katina Street, Turrumurra, NSW	158.00	''	''
Lingane Motors Pty Ltd, "Super Fund A/c", PO Box 241, Hornsby, NSW	288.00	''	28/04/00
Lingane Motors Pty Ltd, "Super Fund A/c", PO Box 241, Hornsby, NSW	360.00	''	27/10/00
Victor Joseph Lipinski, 18/2 Goodwin Street, Kangaroo Point, Qld	120.00	''	''
Geffrey Lipshut, PO Box 221, Caulfield South	140.00	''	''
Lisdawn Pty Limited, 5/15 Ocean Avenue, Double Bay, NSW	100.00	''	''
Peter Lisle, PO Box 11, Camperdown, NSW	168.00	''	''
Liteyork Pty Ltd, 12 Duke Street, Balmain, NSW	120.00	''	''
Anthony William Little, Applecott, Lot 1, Church Street, Burrawang, NSW	100.00	''	''
Fong Yan Liu, 64 Woodbine Cres, Ryde, NSW	192.95	''	28/04/00
Fong Yan Liu, 64 Woodbine Cres, Ryde, NSW	320.00	''	27/10/00
Xiaoyan Liu, 3/5 Bond Street, Hurstville, NSW	144.00	''	28/04/00
Mr Tian Xiong Liu, 4/20 Riversdale Road, Hawthorn	120.70	''	''
Mr Tian Xiong Liu, 4/20 Riversdale Road, Hawthorn	200.00	''	27/10/00
Bing Ren Liu, 51 Winsome Avenue, Plumpton, NSW	150.00	''	''
Mr Ping Chi Liu, 10 Truganini Road, Carnegie	100.00	''	''
Mr Yuhui Liu, 12/15-19 Wright Street, Hurstville, NSW	107.00	''	''
Mr Anlan Liu, 552 Mowbray Road, Lane Cove, NSW	144.95	''	28/04/00
Mr Anlan Liu, 552 Mowbray Road, Lane Cove, NSW	240.00	''	27/10/00
Angela June Liveris, 10 Scaffell Gardens, Carine, WA	112.00	''	28/04/00
David John Livingstone, PO Box 12, Sylvania Waters, NSW	104.00	''	27/10/00
Livorne Investments Pty Ltd, 8 Claude Avenue, Cremorne, NSW	176.00	''	28/04/00
Livorne Investments Pty Ltd, 8 Claude Ave, Cremorne, NSW	160.00	''	''
Lixstar Pty Limited, C/- Coopers & Co, Level 6, 7 Macquarie Place, Sydney, NSW	120.70	''	''
Ms Victoria Ann Lloyd, "Thomas Matthew Lloyd A/c", 53/1 Wellington Crescent, East Melbourne	100.00	''	27/10/00
Harold Lloyd, PO Box 290, Hawthorn	100.00	''	''
Jeffrey Lloyd, PO Box 28, Neutral Bay, NSW	100.00	''	''
Hugh Lloyd, PO Box 7075, Shenton Park, WA	272.00	''	28/04/00
Lloyd Friend Superannuation Pty Ltd, 3 Bailey Street, Point Lonsdale	100.00	''	27/10/00
Leslie George Lobb, 354 Mont Albert Road, Mont Albert	260.00	''	''
Locim Group Aust, PO Box 366, Fitzroy	168.00	''	28/04/00
Locim Group Aust, PO Box 366, Fitzroy	210.00	''	27/10/00
Robert Kenneth Lock, 29 Watton Road, Carlingford, NSW	127.90	''	28/04/00
Robert Andrew Lock, 36 Albion Crescent, Greensborough	100.00	''	27/10/00
Mary Margaret Lockwood, PO Box 283, Market Street, Melbourne	100.00	''	''
Locray Pty Ltd, "Neal Family Super Fund A/c", PO Box 2500, Castle Hill, NSW	1,672.00	''	''
Peter J. Logan, 23 Dillon Grove, Glen Iris	185.00	''	''
Tony Edwin Logue & Katherin Monica Logue, 16 Caroline Street, Dubbo, NSW	100.00	''	''
Lai Cheng Loh, Box 2368, Hawthorn LPO	282.00	''	''
Mr Chor Huat Loh, 59 Tourmaline Crescent, Wheelers Hill,	120.70	''	28/04/00
Kristen Lomas, 55 Veron Street, Wentworthville, NSW	150.00	''	27/10/00

Peter Dudley Lomax, 2/23 Montclair Ave, Glen Waverley	127.90	''	28/04/00
Christopher Lonergan, 63 Edward St, Sydney North, NSW	100.00	''	27/10/00
Jacinta Long, 19/671 Brunswick St, New Farm, Qld	150.00	''	''
Mr Peter Dennis Long, 52 St Johns Avenue, Ashgrove, Qld	100.00	''	''
Rodney Longmire, 2 Sir Claude Gibb St, North Haven, SA	120.00	''	''
Est Louis Edward Longworth, C/- R T Breen & Co, PO Box 38, Brighton	100.00	''	''
Lonsdale Securities Limited, "Settlement Hin", PO Box 179, Collins Street West	1,530.64	''	28/04/00
Sophie Lonum, 60 Birrell Street, Bondi Junction, NSW	100.00	''	27/10/00
Rosemary Lonum, 5/5 Cyan Place, Norwood, SA	200.00	''	''
Siew Loo, San Remo, 50/8 Bligh Place, Randwick, NSW	100.00	''	''
Hans Peter Loomans & Alice Alexandra Loomans, 1 Buckland Road, Casula, NSW	100.00	''	''
Adrian Loomans & Victoria Catherine Loomans, 28 Birdwood Terrace, Auchengflower, Qld	100.00	''	''
Elizabeth Lopez & Stewart Lopez, 2 Mary Street, Brighton	160.00	''	''
Mr Andrew Lopez, 2/36 Ida Street, Niddrie	105.00	''	''
Loreno Pty Ltd, PO Box 467, Grafton, NSW	224.00	''	28/04/00
Loreno Pty Ltd, PO Box 467, Grafton, NSW	280.00	''	27/10/00
Gabriella Lorenzi, 27 Cabena Crescent, Chadstone	220.00	''	''
Luciana Lothringer, 27 Marana Road, Northbridge, NSW	188.00	''	''
Fiona Lotter, 6 Pratico Court, Forest Hill	100.00	''	''
Anna Choy Ngor Louey, 130 Capel St, North Melbourne	130.00	''	''
Dr Simon James Louis, Unit 27, 784 Pacific Highway, Sapphire Beach, NSW	400.00	''	''
Mr Phillip Marshall Loveland, "The Maple Investment A/c", 43 Gardon Rise, Gwelup, WA	2,520.00	''	''
Brian John Lovelock & Irene Lovelock, 3/53 Kangaroo Street, Manly, NSW	128.00	''	28/04/00
Brian John Lovelock & Irene Lovelock, 3/53 Kangaroo Street, Manly, NSW	160.00	''	27/10/00
Mr Simon Lovett & Ms Ann Keenan, 8 Fraser Avenue, Anglesea	315.00	''	''
Siek Foong Low, PO Box 334, Blacktown, NSW	224.00	''	28/04/00
Siek Foong Low, PO Box 334, Blacktown, NSW	280.00	''	27/10/00
Brian Low, "James Danckert A/c", 5 Howard Pde, Salter Point, WA	100.00	''	''
Brian Low, 5 Howard Pde, Salter Point, WA	120.00	''	''
Brian Low, "Frances Danckert A/c", 5 Howard Pde, Salter Point, WA	100.00	''	''
Ms Pauline Low, Unit 70, 115 Herdsman Parade, Wembley, WA	150.00	''	''
Dominic Weng Khong Low, 12/15 Herbert Street, St Leonards, NSW	100.00	''	''
Mrs Margaret Scott Low, 2B Ashleigh Grove, Malvern	160.00	''	28/04/00
Mrs Margaret Scott Low, 2B Ashleigh Grove, Malvern	200.00	''	27/10/00
Miss Suzanne F. Lowe, 10/62-66 Park Rd, Hurstville, NSW	100.00	''	''
Mrs Rachelle Lowin, PO Box 2093, East St Kilda	100.00	''	''
Mr Jimmy Zhen Kang Lu, 1 Warrane Place, East Roseville, NSW	100.00	''	''
Anne Elizabeth Lucas, 4 King Street, Montrose	100.00	''	''
Barry Raymond Lucas, 4 King Street, Montrose	100.00	''	''

Michael Luchich, 86 Lombard Street, Fairfield, NSW	800.00	''	''
Paul Luh, 3/294 Essex Street, West Footscray	100.00	''	''
Ronald Luke, 1447 Burke Road, East Kew	157.05	''	28/04/00
Lukss Pty Ltd, "Superannuation Fund A/c", 53 Cossington-Smith Crescent, Lyneham, ACT	300.00	''	27/10/00
Lunbury Pty Ltd, C/O B. J. Maynes, 53 Andaman Street, Jamboree Heights, Qld	100.00	''	''
John Bryant Lunn, PO Box 9200, Lighthouse Beach Post Office, Port Macquarie, NSW	100.00	''	''
Fairley Ann Lunn, PO Box 9200, Lighthouse Beach Post Office, Port Macquarie, NSW	100.00	''	''
Mr Kevin John Luscombe & Mrs Barbara Joan Luscombe, 14 Cadby Street, Brighton	133.00	''	''
Ms Que Thanh Luu, 33 Dover Street, Summer Hill, NSW	500.00	''	''
Mr Bruce Aston Luxton, 14 Watson Avenue, Mandurah, WA	130.00	''	''
Cam Giang Ly & Julia Lo, 10/10 Inlerman Street, Granville, NSW	100.00	''	''
Ngek Keang Ly, 90 Corio Drive, Springvale South	300.00	''	''
Mr Hav Ly, 35 Quondong Avenue, Parafield Gardens, SA	100.00	''	''
Mrs Soun Ly, 195 Kosciusko Avenue, Palmerston, ACT	500.00	''	''
William James Lynch, "Davis & Davis S/F No 2 A/c", PO Box 328, Beaconsfield, NSW	100.00	''	''
Michael Lynch, "Joseph Lynch Account", 39 Eric Avenue, Lower Templestowe	100.00	''	''
Barbara Marie Lynch, 11/2 Sandford Street, St Lucia, Qld	100.00	''	''
Mrs Kylee Lynch, Unit 1, 38 Acher St, Chatswood, NSW	200.00	''	''
Lyncorp Securities Staff Superannuation Pty Ltd, PO Box 318, Kingsgrove, NSW	140.00	''	''
Nathan James Lynham, 45 Illuta Street, Rasmussen, Qld	100.00	''	''
Rhonda Estelle Lynn & Deborah Anne Lynn, 1/16-22 Willock Aven, Miranda, NSW	100.00	''	''
Kevin Lynn, 40 Regent Street, Paddington, NSW	100.00	''	''
Peter Lyons, PO Box 48, Pyrmont, NSW	150.00	''	''
Mr Patrick Francis Lyons & Mrs Linus Ann Lyons, "Lyons Practice S/F A/c", 59 Augusta Rd, Lenah Valley, Tas.	100.00	''	''
Mr Patrick Francis Lyons, 59 Augusta Rd, Lenah Valley, Tas.	100.00	''	''
David James Lyons, 235 Brisbane Street, Dubbo, NSW	100.00	''	''
Norman Leslie Lyons, Palms Oasis Caravan Park, 861 Boomerang Drive, Pacific Palms, NSW	100.00	''	''
Mr Patrick Francis Lyons & Mrs Linus Ann Lyons, "Lyons Practice S/F A/c", 59 Augusta Rd, Lenah Valley, Tas.	100.00	''	''
Mr Peter Alan Lyttle, 24 Jasmine Street, Colo Vale, NSW	120.70	''	28/04/00
Mr Peter Alan Lyttle, 24 Jasmine Street, Colo Vale, NSW	200.00	''	27/10/00
M. A. K. Investment Holdings Pty Ltd, "MAK Family A/c", 10 Snowy Place, Sylvania Waters, NSW	132.85	''	28/04/00
M R Technology Pty Ltd, "Rudas Family S Fund A/c", 175 Ryecroft, Darlington, WA	160.00	''	''
M R Technology Pty Ltd, "Rudas Family S Fund A/c", 175 Ryecroft, Darlington, WA	200.00	''	27/10/00
Mr Long-Xin Ma, PO Box K1146, Haymarket, NSW	210.00	''	''
Maas-Neotek Pty Ltd, GPO Box 2, Sydney, NSW	150.00	''	''
Penny Jane Mabbutt, "Nicolas Mabbutt A/c", 24 Royce Street, Greystanes, NSW	112.00	''	28/04/00

Nancie Mac, 97 Elfreda St, Enoggera, Qld	120.00	''	27/10/00
Mac Transport Pty Ltd, "Mac Transport S/Fund A/c", 5 Dolphin Court, Tullamarine	160.00	''	28/04/00
Ray Macaitis, "Ray Macaitis P/L S/Fund A/c", C/- 1294 North East Road, Tea Tree Gully, SA	100.00	''	27/10/00
Colin MacDonald, 4 Moss Avenue, Mount Helen	130.00	''	''
Mr Colin MacDonald, 212 Lyons Street North, Ballarat	100.00	''	''
Mr William Donald MacDonald, GPO Box 2358, Sydney, NSW	120.70	''	28/04/00
Mr William Donald MacDonald, GPO Box 2358, Sydney, NSW	200.00	''	27/10/00
Mrs Elizabeth MacDonald, 27 Carlops Crescen, Penicuik Midlothian, Scotland EH26 ODW United Kingdom	100.00	''	''
Karen Joanne MacDonough, 36 Daisy Street, Essendon	100.00	''	''
Bryce MacDonough, 36 Daisy Street, Essendon	100.00	''	''
Karen MacDonough, 36 Daisy Street, Essendon	100.00	''	''
Mrs Susan Robyn MacGregor, Lot 1 Wearden Road, Oxford Falls, NSW	150.00	''	''
MacIver Pty Ltd, "Superfund A/c", C/- A. C. Pilmer, GPO Box B88, Perth, WA	100.00	''	''
Ms Jill MacKaness, C/- Mr B. Thompson, Ord Minnett Limited, GPO Box 3804, Sydney, NSW	120.70	''	28/04/00
Alan Robert John MacKay, 1 Gibb Street, North Dandenong	160.00	''	''
Alan Robert John MacKay, 1 Gibb Street, North Dandenong	200.00	''	27/10/00
Malcolm William MacKay, 40 Sydare Avenue, Malvern East	150.00	''	''
MacKechnie (Mit) Pty Ltd, 7 Gordon Crescent, Blackburn	270.15	''	28/04/00
MacKechnie (Mit) Pty Ltd, 7 Gordon Crescent, Blackburn	448.00	''	27/10/00
Kaylee Ann MacKenzie, 28 Wattle Avenue, Beaumaris	100.00	''	''
Alexander Hay MacKenzie, GPO Box 2684, Sydney, NSW	128.00	''	28/04/00
Alexander Hay MacKenzie, GPO Box 2684, Sydney, NSW	160.00	''	27/10/00
Ms Anita Jane MacKenzie, 112 Seaforth Crescent, Seaforth, NSW	695.75	''	28/04/00
John D. MacKey, 75 Connemarra Street, Bexley, NSW	132.85	''	''
John D. MacKey, 75 Connemarra Street, Bexley, NSW	220.00	''	27/10/00
Ms Naomi Jane MacKinlay, 16 Jackson St, Balgowlah NSW	288.00	''	28/04/00
Ms Naomi Jane MacKinlay, 16 Jackson St, Balgowlah, NSW	360.00	''	27/10/00
Ms Jennifer MacKlin, Unit 3, 26 Chester St, Petersham, NSW	100.00	''	''
Mr Thomas Kay MacLachlan, PO Box 761, Traralgon	120.70	''	28/04/00
Mr Thomas Kay MacLachlan, PO Box 761, Traralgon	200.00	''	27/10/00
MacLaw Super Number 8 Pty Ltd, 3rd Floor, 608 St Kilda Road, Melbourne	1,000.00	''	''
Dean Colin MacMullen, GPO Box 496, Adelaide, SA	100.00	''	''
Ritzia Macovski, 25 Maryston Street, Yarraville	100.00	''	''
Mr Con MacRee, 5/27 Rickard Avenue, Bondi, NSW	100.00	''	''
Richindera Dev Singh Madan, 3 Maylands Crescent, Glen Waverley	100.00	''	''
Stephen Geoffrey Maddern & Carolyn Mary Maddern, 2 Shepherdson Road, Mt Gambier, SA	120.00	''	''
Tracey A. Maddicks, 33 Salisbury Road, Ashwood	250.00	''	''
Mr Michael James Madigan, 172 Birrell Street, Bondi Junction, NSW	181.30	''	28/04/00
Janet Maggacis, 3 Chelsea Court, Carindale, Qld	100.00	''	27/10/00
Chris Maggacis, 3 Chelsea Court, Carindale, Qld	100.00	''	''

Chris Maggacis & Janet Maggacid, 3 Chelsea Court, Carindale, Qld	100.00	''	''
Giovanna Maggiore, 27 Clydesdale Road, Airport West	100.00	''	''
Ms Alison Magri, "Magri Family A/c", 8 Jean St, Essendon	200.00	''	''
Peter Magro, 11 Mansfield St, Wetherill Park NSW	157.05	''	28/04/00
Peter Magro, 11 Mansfield St, Wetherill Park, NSW	260.00	''	27/10/00
Mr Brian Thomas Maguire & Mrs Elizabeth Jane Powell-Maguire, "Aus Am Super Fund A/C", PO Box 74, Mount Buller	200.00	''	''
Mr Daniel Magyar, 9A Raphael Street, Caulfield North	100.00	''	''
Audrie Wye Peng Mah, 'San Siena', 10/121 Sir Fred Schonell Drive, St Lucia, Qld	200.00	''	''
Ahmad Mahboobi, 17 Stutt Avenue, Doncaster	100.00	''	''
Mahdokht Mahboobi, 17 Stutt Avenue, Doncaster	100.00	''	''
Frank Maher & Marlene Maher, 36 Foch St, Box Hill South	100.00	''	''
Lynne Maher, 67a Woorarra Avenue, Elanora Heights, NSW	228.00	''	''
Nicholas John Maher, 8/36 Byron Street, Elwood	100.00	''	''
Asif Mahmood, PO Box 734, Burwood, NSW, 2/120 Sproule Street, Lakemba, NSW	260.00	''	''
Estate Terry Mahoney, 12 Allambee Crescent, Beverly Hills, NSW	110.00	''	''
Mrs Paris Mahony, 391 New Street, Brighton	120.00	''	''
Mr John Mahony, "Superannuation Fund A/c", 34 Mills Street, Middle Park	100.00	''	''
Parli Mahony, 391 New Street, Brighton	140.00	''	''
Finton Mahony, 17 Foss Street, Glebe, NSW	100.00	''	''
Mr James Mahood, 14 Krystal Place, Kuraby, Qld	120.00	''	''
Mrs Dina Maiale, 2 Phillis Street, Maylands, SA	109.00	''	''
Gregory Bruce Main, 10 Anthony Street, Largs Bay, SA	148.00	''	''
James Richard Mair, 49 Kendall Street, Campbelltown, NSW	100.00	''	''
Maison Group Pty Ltd, "Super Fund A/c", 7 Courtice Close, Fadden, ACT	300.00	''	''
Henryk Majewski & Evelyn Mary Majewski, 28 Shandon Street, Mornington	160.00	''	''
Ai Huay Mak, 21 Gibbon Avenue, Vermont South	160.00	''	''
Eugene Kashing Mak, 6 Johnson Street, Lindfield, NSW	150.00	''	''
Yen Kong Mak, 21 Gibbon Avenue, Vermont South	100.00	''	''
Yen Huat Mak, 21 Gibbon Avenue, Vermont South	100.00	''	''
Andrew Mak, 9 Crimson Avenue, Blackburn South	100.00	''	''
King Chi Mak, 12 Undine Street, Russell Lea, NSW	126.75	''	28/04/00
King Chi Mak, 12 Undine Street, Russell Lea, NSW	210.00	''	27/10/00
Makalski Holding Pty Ltd, "FJM Super Fund A/c", 16 Frank Street, Vermont	180.00	''	''
Makalski Holdings Pty Ltd, "FJM Super Fund A/c", 16 Frank Street, Vermont	100.00	''	''
Makalski Holdings Pty Ltd, "FJM Super Fund A/c", 6 Frank Street, Vermont	201.73	''	28/04/00
Makalski Holdings Pty Ltd, "FJM Super Fund A/c", 6 Frank Street, Vermont	334.60	''	27/10/00
Kevin Malakos, C/- Tower Trust Ltd, GPO Box 546, Adelaide, SA	120.70	''	28/04/00
Mr Ramsin Malek, 12 Ashur Crescent, Greenfield Park, NSW	120.00	''	27/10/00
Ms Rebecca Malin, 3 Tatiara Road, Happy Valley, SA	100.00	''	''

Man Nominees Pty Ltd, "Executive Benefit A/c", 4/2 Claremont St, South Yarra	1,305.60	"	28/04/00
Man Nominees Pty Ltd, "Executive Benefit A/c", 4/2 Claremont St, South Yarra	1,632.00	"	27/10/00
Management Consultancy & Organisation Pty Ltd, 8 Katrina Avenue, Mona Vale, NSW	120.00	"	"
Andrew Manchee, 94 MacPherson, Cremorne, NSW	100.00	"	"
David Manchester, 51 Ailsa Street, Wembley Downs, WA	140.00	"	"
Julie Manciseh, 33 Aruma Way, City Beach, WA	100.00	"	"
Mandu Pty Ltd, "Super Fund A/c", 23 Spotted Gum Way, Willetton, WA	300.00	"	"
Phillip Louis Maney & Leanne Maney, "P L & L Maney S/Fund A/c", PO Box 701, Rosny Park, Tas.	100.00	"	"
James Mangan, 475 Ballan Road, Moorabool	112.00	"	28/04/00
Mr Arthur Mangan, 348 Great Western Highway, Warrimoo, NSW	100.00	"	27/10/00
Geraldine Catherine Mangano, 27 Golfers Parade, Pymble, NSW	240.00	"	"
Rocco Paul Mangano, 27 Golfers Parade, Pymble, NSW	200.00	"	"
Jacqueline Kristin Manger, 12/39 Cairns Street, Kangaroo Point, Qld	100.00	"	"
Kerrie Maree Mann, 32 Gilsland Road, Murrumbena	160.00	"	28/04/00
James Patrick Manning, C/- The Principals Residence, Stuart Holme School, Birdwood Terrace, Toowong, Qld	112.00	"	"
James Patrick Manning, C/- The Principals Residence, Stuart Holme School, Birdwood Terrace, Toowong, Qld	140.00	"	27/10/00
Mrs Barbara Ogilvy Carleton Manning Fernbank, Unit 11, 14/18 Kareela Road, Cremorne, NSW	100.00	"	"
Timothy A. H. Manns & Kimberley R. H. Manns, 83 Abingdon Road, Roseville, NSW	150.00	"	"
Dorothy Manstone, 2 Bank Street, Windsor, Qld	220.00	"	"
Frank Mao & Jan Lu, 2A/148 Canterbury Road, Bankstown, NSW	2,128.00	"	"
Ms Carmela Marando, 13 Lasscock Avenue, Lockleys, SA	100.00	"	"
Est Merle Doreen Maraun, PO Box 1150, Mudgeeraba, Qld	200.00	"	"
Angelita Marave, Missionaries of Christ In The Eucharist (MACE), 242 Pacific Palms Circuit, Hoxton Park, NSW	112.00	"	28/04/00
Mr Armando Marcon, 14 Bevan Avenue, Clayton South	100.00	"	27/10/00
Mr Samir Ayad Marcos, 1 Richlands Place, Prestons, NSW	412.00	"	"
Mr Samir Marcos & Mr Andrew S. Marcos, 1 Richlands Place, Prestons, NSW	315.00	"	"
Mardan Enterprises Pty Ltd, Level 9, 82 Ann Street, Brisbane, Qld	120.00	"	"
Carly Marget, 5 Devon Street, Caulfield	100.00	"	"
Anthony Francis Mariani, 4 Lytton Street, Kew	100.00	"	"
Marieke Pty Ltd, "Marieke P/L-1st Flr Synd A/c", C/- Owenell & Co, Locked Bag 2000, Nedlands, WA	120.70	"	28/04/00
George Marinopoulos & Elizabeth Marinopoulos, 24 Martin Street, Thornbury	100.00	"	27/10/00
Elizabeth Marinopoulos & George Marinopoulos, 4 Martin Street, Thornbury	100.00	"	"

John Marinovic & Spiroula Marinovic, 90 Livingstone Street, Ivanhoe	100.00	''	''
Mr Andrew Marker, 69 Talbot Avenue, Como, WA	140.00	''	''
Marketing Formulas Pty Limited, "Marketing Formulas S/F A/c", C/- Tasker & Co, 250 Flinder Street, Adelaide, SA	189.90	''	28/04/00
Peter Markovic, 46 Stevenson Street, Kew	100.00	''	27/10/00
Mrs Shereen Markunsky, 10 Phillip Road, St Ives, NSW	120.70	''	28/04/00
Debbie Marl, Lot 2 Ducats Road, Tallebudgera, Qld	112.00	''	''
Ms Samantha Marlow, 206 Attunga Road, Yowie Bay, NSW	200.00	''	27/10/00
Marole Pty Ltd, 1108 Collingwood 3066, 1-35 Wellington Street, Collingwood	112.00	''	28/04/00
Marole Pty Ltd, 1108 Collingwood 3066, 1-35 Wellington Street, Collingwood	140.00	''	27/10/00
Douglas John Anderson Marr & Abigail Ann Marr, "John Marr Superfund A/c", 7 Enderley Ave, Clayfield, Qld	100.00	''	''
Troy B. Marsden, 3 Marsden Street, Clayfield, Qld	144.80	''	28/04/00
Ms Michaela Samantha Marsh & Ms Emily Jane Marsh & Ms Rachel Marsh, 4 Corlette Street, Cooks Hill, NSW	100.00	''	27/10/00
Mr Gavin Marshall & Ms Rosemary Marshall & Mr Brett Marshall, C/- Unit 11, 508 Glenferrie Road, Hawthorn	112.00	''	28/04/00
Melissa Marea Marshall, 1/23 Villiers Street, Yokine, WA	150.00	''	27/10/00
Mr Brett Marshall, 289 Moray Street, South Melbourne	160.00	''	''
Melanie Marshall & Kathleen Kusiniski, Level 8, 233 Adelaide Terrace, Perth, WA	112.00	''	28/04/00
Melanie Marshall & Kathleen Kusiniski, Level 8, 233 Adelaide Terrace, Perth, WA	140.00	''	27/10/00
Mr James Marshall, 5/118 Milson Rd, Cremorne Point, NSW	120.70	''	28/04/00
Mr Andrew Sean Marshall, C/- 49 Alpha St, Camden, NSW	100.00	''	27/10/00
Wendy D. Marshall, 46 McNeill Road, Kallangur, Qld	105.00	''	''
Eleanor Martin, 93/35A Sutherland Crescent, Darling Point, NSW	176.00	''	28/04/00
Eleanor Martin, 93/35A Sutherland Crescent, Darling Point, NSW	220.00	''	27/10/00
Antony Seymour Martin, 9/174 Phillip Street, Sydney, NSW	100.00	''	''
Mr Richard John Martin, PO Box 2142, Canberra MC, ACT	100.00	''	''
Claude Thomas Martin & Margaret Anne Martin, 41 Maitland Street, Davidson, NSW	206.64	''	28/04/00
Roy Gibson Martin, "Martin Family A/c", 9 Bligh Crescent, Seaforth, NSW	240.00	''	''
Roy Gibson Martin, "Martin Family A/c", 9 Bligh Crescent, Seaforth, NSW	300.00	''	27/10/00
Malcolm Martin, 166 Robbin Head Road, Turrumurra, NSW	301.55	''	28/04/00
Malcolm Martin, 166 Robbin Head Road, Turrumurra, NSW	500.00	''	27/10/00
Gregory Paul Martin, PO Box 223, Canning Vale, WA	118.40	''	28/04/00
Gregory Paul Martin, PO Box 223, Canning Vale, WA	148.00	''	27/10/00
Mr Peter Rohan Martin, 14/25 Croydon St, Cronulla, NSW	400.00	''	''
Mr John Raymond Martin, Suite 253, 29 Byron Ave, Takapuna, Auckland, New Zealand	340.00	''	''
Dr Peter Anthony Martin & Mrs Sophie Martin, "Super Fund A/c", 13 Lancaster Rd, Dover Heights, NSW	260.00	''	''
Jane Martindale, 5 Tonimbuk Road, Tonimbuk	100.00	''	''

Mr Angel Martinez & Mrs Mardy Martinez, Lot 10, Empire Bay Drive, Bensville, NSW	100.00	''	''
Noela Mary Janice Martinez, 34 Kerenjon Avenue, Buderim, Qld	120.00	''	''
Maryella Pty Ltd, "Superannuation Fund A/c", PO Box 466, Bairnsdale	132.00	''	''
Pauline Masefield, 103 Kalgoorlie, Mount Hawthorne, WA	189.84	''	28/04/00
Antony John Masefield, 103 Kalgoorlie Street, Mt Hawthorn, WA	189.84	''	''
Jeanne Marie Masefield, 103 Kalgoorlie Street, Mount Hawthorn, WA	189.84	''	28/04/00
Christian John-Lance Mason, 29 Severn St, North Balwyn	120.70	''	''
Christian John-Lance Mason, 29 Severn St, North Balwyn	200.00	''	27/10/00
Mr Anthony John Mason, 70 Burrandong Crescent, Baulkham Hills, NSW	160.00	''	''
Mr Stuart John Mason, 1 Gulls Way, Frankston	100.00	''	''
Franco Antonio Massalongo & Teresa Lydia Massalongo, 39 Rose Street, Prospect, SA	100.00	''	''
Ms Terera Lydia Massalongo & Mr Franco Antonio Massalongo, 39 Rose Street, Prospect, SA	100.00	''	''
Bradley Massoud, 10 Phillis Street, Elwood	200.00	''	28/04/00
Jackie Mastorides, Suite 50, 350 Kings Way, Caringbah, NSW	100.00	''	27/10/00
Kon Mastrogiannis & Joan Mastrogiannis, 35 Kenman Close, Templestowe	100.00	''	''
Panteleon Mastrosavas, 147 Landells Road, Pascoe Vale	200.00	''	28/04/00
Panteleon Mastrosavas, 147 Landells Road, Pascoe Vale	250.00	''	27/10/00
Ms Ann Terese Mataczynna, Unit 4, 3 Eustace Street, Manly, NSW	100.00	''	''
Mr Anthony Mataic, 75 Litten Rd, Howick, Auckland, NZ	320.00	''	''
Stephen Robert Matchett, Unit 4, 246 Chalmers Street, Redfern, NSW	120.00	''	''
John Alexander Mate, 35 Northcote Street, Canterbury, NSW	100.00	''	''
Matelinda Nominees Pty Ltd, 2 Rowell Road, Glenunga, SA	300.00	''	''
Myra Materne, 2 Wandilta Street, Kadina, SA	240.00	''	''
Michael Anthony Mather, 36 Wrightson Avenue, Newcastle, NSW	100.00	''	''
Mr John Mathews, Unit 5, 2 Marita Road, Nedlands, WA	100.00	''	''
Mr Max Geoffry Mathews, 3 Westborne Drive, Nowra, NSW	242.00	''	''
Mr Craig Maxwell Mathews & Mrs Susan Gaye Mathews, 3 Westbourne Drive, Nowra, NSW	242.00	''	''
Claire Mathieson, 2 Bendigo Street, Collingwood	240.00	''	''
George James Matis, 141 Hopetoun Avenue, Vacluse, NSW	100.00	''	''
Joan Therese Matison, C/- Post Office, Reservoir	192.00	''	28/04/00
Joan Therese Matison, C/- Post Office, Reservoir	240.00	''	27/10/00
Vasko Matos, 19 Lily, Wetherill Park, NSW	100.00	''	''
Yuri Matov, 24 Lindsay Street, Mckinnon	120.70	''	28/04/00
Miss Irene Matson, C/- 106 Mckean Street, Fitzroy North	100.00	''	27/10/00
Frances Jane Matthews, 21 Prince Albert St, Mosman, NSW	288.00	''	28/04/00
Justin Matthews, 18 Coopernook Ave, Gymea Bay, NSW	157.05	''	''
Janet A. Matthews, Unit 3/13 Brougham Street, Box Hill	320.00	''	''
Mr Edgar Mattle, C/- PO Box N689, Grosvenor Place, Sydney, NSW	181.30	''	28/04/00
Glen Anthony Mattocks, 41 Petterd Street, Page, ACT	100.00	''	27/10/00

Aung Win Maung, 18 Gibbs Street, Croydon, NSW	100.00	''	''
Maximove Pty Ltd, PO Box 31, Chelsea	100.00	''	''
Kerry May, 98 Ferris Street, Annandale, NSW	106.91	''	28/04/00
Kerry May, 98 Ferris Street, Annandale, NSW	176.70	''	27/10/00
Mr Tyson J. May, Unit 2, 4 Marine Parade, The Entrance, NSW	155.00	''	''
Rodney James May, 24 Forest Court, Templestowe	120.70	''	28/04/00
William May, 12 Stockdale Avenue, Clayton	105.60	''	''
Anthony Mayes, 1/2 Parkes Road, Artarmon, NSW	100.00	''	27/10/00
William Ronald Maynard, 5/1 Hendry Street, West Sunshine	150.00	''	''
Phillip Mayton, 13 Intrepid Drive, Victoria Point, Qld	120.00	''	''
Karl Mazmanians, 20 Pendley Cr, Quakershill, NSW	320.00	''	''
Mr Robert Lee McHugh, 39 Olive Street, Prospect, SA	800.00	''	''
Mr Edward McIntosh, C/- C I B City Police Station, 316 Adelaide Street, Brisbane, Qld	150.00	''	''
Mr Michael Peter William McKenna, PO Box 319, Kempsey, NSW	670.00	''	''
Mr Scott Michael McAlister, 3 Currong Street, Reid, ACT	300.00	''	''
Sue McAlpine, 4 Gurnard Court, Sorrento, WA	100.00	''	''
Patricia McAnuff, 5 Orana Crescent, Brentwood, WA	120.00	''	28/04/00
Anne McArdle, 29 Uvadale Grove, Kew	120.00	''	''
Estate Robert George McAulay, C/- Hills Solicitors, PO Box 44, Maitland, NSW	100.00	''	27/10/00
Michael Edward McBrearty, 6 Rossleigh Court, Closeburn, Qld	100.00	''	''
Miss Kelly Anne McBride, 19 Avoca Drive, Erina, NSW	140.00	''	''
Ms Emma Sue McBryde, 9 Curlew Place, Riverhills, Qld	124.00	''	''
Gillian Mary McCall, 1 Kandara Close, Middle Dural, NSW	190.00	''	''
Mr Carl Duncan McCamish, C/- Ardmona Post Office, Ardmona	300.00	''	''
Stewart McCandlish & Kathy McCandlish, 90 Cranhaven Road, Langwarrin	120.00	''	27/10/00
Mrs Joyce Alice McCann, 5 Pickering Lane, Woollahra, NSW	128.00	''	28/04/00
Mrs Joyce Alice McCann, 5 Pickering Lane, Woollahra, NSW	160.00	''	27/10/00
Margaret McCann, 90 Kurrajong Road, Jimboomba, Qld	100.00	''	''
George McCann, 90 Kurrajong Road, Jimboomba, Qld	100.00	''	''
Francis McCann, 90 Kurrajong Road, Jimboomba, Qld	100.00	''	''
Christine Marj McCann, 41/22 Agnes Street, Jolimont	154.05	''	28/04/00
Christine Marj McCann, 41/22 Agnes Street, Jolimont	255.00	''	27/10/00
George McCann, "Kevin Jurgens A/c", 93 Bennetts Road, Camp Hill, Qld	100.00	''	''
George McCann, "Lisa Jurgens A/c", 93 Bennetts Road, Camp Hill, Qld	100.00	''	''
George McCann, "Katrina Jurgens A/c", 93 Bennetts Road, Camp Hill, Qld	100.00	''	''
Mr Robert M. McCann, PO Box 120, Kogarah,, NSW	240.00	''	28/04/00
Mr Robert M. McCann, PO Box 120, Kogarah, NSW	300.00	''	27/10/00
Rosaleen McCarthy, 467 North Beach Road, Gwelup, WA	110.00	''	''
John Ashton McCausland, 4 Cluden St, Holland Park, Qld	112.00	''	28/04/00
Leonie McCleary, "McCleary Family Account", 66 Walter Street, Mortdale, NSW	100.00	''	27/10/00
Winston McClelland, 21 Wainwright Avenue, Padstow, NSW	120.00	''	28/04/00
Paul Thomas McClure, 28 Tenth Avenue, St Peters, SA	100.00	''	27/10/00

James Michael McColgam, 68 Fremont Parade, Ardeer	100.00	''	''
Mrs Natasha Alison McComb, 37 Livingstone St, Ivanhoe	200.00	''	28/04/00
Mrs Natasha Alison McComb, 37 Livingstone St, Ivanhoe	250.00	''	27/10/00
Mr Robert McCombe, 4/39 Herbert St, St Leonards, NSW	135.00	''	''
Gerard Francis McCormick, 14 Deakin Crescent, Dandenong	100.00	''	''
Craig John McCormick, PO Box 46600, Sheikh Hamoan Street, Abu Dhabi UAE	115.26	''	28/04/00
Craig John McCormick, PO Box 46600, Sheikh Hamoan Street, Abu Dhabi UAE	170.00	''	27/10/00
William Murray McCowan, 21 Halliday St, Mount Waverley	100.00	''	''
Ian R. McCowat, 12 Ray Street, Traralgon	110.00	''	''
Ms Mairead McCoy, 7 Hadlow Court, Leeming, WA	136.00	''	28/04/00
Donna Wendy McCray, 5 Frances Street, Gwynneville, NSW	166.60	''	27/10/00
Ms Karen L. McCroary, 1/122 Danks Street, Albert Park	412.80	''	28/04/00
Ms Karen L. McCroary, 1/122 Danks Street, Albert Park	516.00	''	27/10/00
David McCrohon & Lisa McCrohon, PO Box 365, Cronulla, NSW	200.00	''	''
Mr William McCrory & Ms Lorraine Norman, "TESP Super Fund A/c", 56 Cowles Road, Mosman, NSW	100.00	''	''
James McCrystal, 4 Bass Close, East Cannington, WA	200.00	''	''
Estate Thomas Gerard McCue, "Thomas Account", 59 Troughton Road, Sunny Bank, Qld	100.00	''	''
David Keith McCullough, 11 Duckett Street, Doncaster East	100.00	''	''
Shelley Louise McDavitt, 12 Shasta Grove, Lesmurdie, WA	120.00	''	''
Mr Ronald Kenneth McDermott & Mrs Christina McDermott, "RK & CJ Retirement A/c", Arncliffe, NSW	100.00	''	''
Amanda McDiarmid, "McDiarmid/Gorr S/Fund A/c", Unit 1, 23 Parkway Avenue, Bar Beach, NSW	100.00	''	''
Anna Margaret McDonald, 89 Berkeley Street, Hawthorn	200.00	''	''
Alexander McDonald, C/- PO Box Z5225, Perth WA	189.90	''	28/04/00
Alexander McDonald, C/- PO Box Z5225, Perth, WA	315.00	''	27/10/00
Lisa McDonald, 68 Agnes Street, Rockhampton, Qld	100.00	''	''
William Herbert McDonald, 17 The Ridge, Mount Eliza	100.00	''	''
David John McDonald, 64 Garden Street, Warrnambool	100.00	''	''
Mr Craig Forbes McDonald, 15 Pindari Crescent, Queanbeyan, NSW	100.00	''	''
Mr Philip Andrew McDonald, "Philip McDonald S/F A/c", Unit 1, 393 Draper Street, Cairns, Qld	120.70	''	28/04/00
Mr Philip Andrew McDonald, "Philip Mcdonald S/F A/c", Unit 1, 393 Draper Street, Cairns, Qld	200.00	''	27/10/00
Mr Enrique Ryan McDonald & Mr Thomas Kaplan & Mr Joe Jeu Fi Lay, 326 Bennetts Road, Norman Park, Qld	100.00	''	''
John Lachlan McDonald, 23 Buckingham Rd, Killara, NSW	100.00	''	''
Michael McDonnell, 5 Dolphin Court, Tullamarine	256.00	''	28/04/00
Joan McDonnell, 5 Dolphin Court, Tullamarine	205.60	''	''
Daniel McDonnell, 5 Dolphin Court, Tullamarine	169.60	''	''
George Anthony McDougall, 24 Driftwood Place, Swanbourne, WA	100.00	''	27/10/00
Paul Gregory McEvedy & Mary Rosanna McEvedy, 123 Angelo St, South Perth, WA	100.00	''	''

Mr Wade Anthony McFarlane, 115 Ashley Street, Chatswood, NSW	128.00	''	28/04/00
Sara Lisa McGaughey, 2/4 Oakpark Drive, Chadstone	100.00	''	27/10/00
Mr John McGee, 75 Darley Road, Bardwell Park, NSW	200.00	''	''
Ms Tiffany McGhee, C/- Nestle, 60 Bathurst Street, Sydney, NSW	100.00	''	''
Isobel McGinnes, 222 Lavidge Road, Ashwood	140.00	''	''
Dianne McGinnes, 222 Lavidge Road, Ashwood	140.00	''	''
McGirr Information Technology Pty Limited, Level 2 71 Longuevil, Lane Cove, NSW	100.00	''	''
Maryanne McGowen, 7/21 Baden Rd, Neutral Bay, NSW	110.00	''	''
Michael J McGrath & Helen T. McGrath, 30 Kent Road, Narre Warren	100.00	''	''
Jessica Grace McGrath, 154 Broadgully Rd, Diamond Creek	134.40	''	28/04/00
Mr David Christopher McGrath, 111 Brighton Street, Petersham, NSW	100.00	''	27/10/00
Carieen McGuin, 56 Byron Court, Albermarle Place, Phillip, ACT	170.00	''	''
Erin McGuinness, 19 Walbundry Avenue, North Balwyn	128.00	''	28/04/00
John McGuinness, "Andrew McGuinness A/c", PO Box 40, Canterbury	100.00	''	27/10/00
John McGuinness, "Kieran McGuinness A/c", PO Box 40, Canterbury	100.00	''	''
Paul D. McGuinness, C/o 5 Mackay Street, Ashfield, NSW	112.10	''	''
Vivienne Janine McGuire & Michael Boateng Boahene, "Super Fund A/c", 5 Irving Street, Newport	210.00	''	''
Gayle Christine McGuirk, PO Box 8068, Alice Springs, NT	240.00	''	''
Mr Bruce William McHenry, 6/825 Park Street, Brunswick	128.00	''	28/04/00
Mr Bruce William McHenry, 6/825 Park Street, Brunswick	160.00	''	27/10/00
McHudson Pty Ltd, 15 Blackwood Crescent, Campbellfield	100.00	''	''
Mrs Shoko McInerney & Mr Peter McInerney, 28 Ethel Street, Forestville, SA	144.95	''	28/04/00
Mrs Shoko McInerney & Mr Peter McInerney, 28 Ethel Street, Forestville, SA	240.00	''	27/10/00
Mr Bruce McInnes, 23-07 5000b Laguna Park, Marine Parade Road 449285 Singapore	147.80	''	28/04/00
Mr Harold John McIntosh, PO Box 836, Mackay, Qld	120.70	''	''
Mr Harold John McIntosh, PO Box 836, Mackay, Qld	200.00	''	27/10/00
Mr Craig Douglas McIntosh, PO Box A876, Sydney South, NSW	200.00	''	''
Francis Christopher McIntyre & Suzanne Marie Pickert, 21 Carlton Street, Highgate, SA	120.00	''	''
Rachel E. McIver, 2/14 Arcadia Street, Box Hill South	120.00	''	28/04/00
Peter Walter McKay, Suite 8, 200 Toorak Road, South Yarra	384.00	''	''
Mr Jason Raymond McKay, 79 Burwood Rd, Belfield, NSW	100.00	''	27/10/00
Mr Keith McKay, Homer Beacon Road, Maiden Gully	290.00	''	''
Peter McKellam, PO Box 5, Hunters Hill, NSW	100.00	''	''
Mr McKenna, PO Box 11, C/- Ri Clifton Pty Ltd, Camden, NSW	133.95	''	28/04/00
Mr McKenna, PO Box 11, C/- Ri Clifton Pty Ltd, Camden, NSW	222.00	''	27/10/00
Mr Peter McKenna, PO Box 1580, Darwin, NT	118.98	''	28/04/00
Mr Peter McKenna, PO Box 1580, Darwin, NT	196.60	''	27/10/00

Geoffrey McKenzie & Rene McKenzie, 21/9 Anderson Street, Neutral Bay, NSW	120.00	''	''
Peter Glen McKenzie, 59 Maxwell St, Turrumurra,, NSW	116.00	''	28/04/00
Peter Glen McKenzie, 59 Maxwell St, Turrumurra, NSW	145.00	''	27/10/00
Bruce John McKeon, "McKeon Family A/c", 8 Newton Grove, Glen Waverley	112.00	''	28/04/00
Kevin Sydney McKern, 39 Forbes St, Woolloomaloo, NSW	120.00	''	27/10/00
Jamie McLachlan, 12 Banksia Place, Oakdale NSW	205.60	''	28/04/00
Jamie McLachlan, 12 Banksia Place, Oakdale, NSW	257.00	''	27/10/00
Miranda McLachlan, 4 Faussett St, Albert Park	100.00	''	''
Loris McLachlan, 3 Kell Place, Templestowe	112.00	''	28/04/00
Loris McLachlan, 3 Kell Place, Templestowe	140.00	''	27/10/00
Noel David McLachlan, 116 Beaconsfield Parade, Albert Park	114.65	''	28/04/00
Mr John McLaren, PO Box 12395, A Beckett Street, Melbourne	160.00	''	''
Mr John McLaren, PO Box 12395, A Beckett Street, Melbourne	200.00	''	27/10/00
Julia McLaughlin, Castor Ave, Coorparoo, Qld	100.00	''	''
Mr Andrew McLean, 37 Holloway Street, Carnegie	100.00	''	''
Colin Neil McLelland, 2/29 Pacific Street, Manly, NSW	100.00	''	''
William Robert McLennan & Lynette Jean McLennan, RMB 7610, Bungador	108.00	''	''
Mr Scott McLennan, 204 Edgecliff Road, Woollahra, NSW	120.70	''	28/04/00
Mr Scott McLennan, 204 Edgecliff Road, Woollahra, NSW	200.00	''	27/10/00
Mrs Helen Lorraine McLeod, C/- Mr J. R. Connor, 46 Newman Road, Mooroolbark	336.00	''	28/04/00
Mr Mark W. McLucas, 121 Short Street, Birchgrove NSW	665.60	''	''
Mr Mark W. McLucas, 121 Short Street, Birchgrove, NSW	832.00	''	27/10/00
Estate Bruce McMahan, C/- Jennifer Weate, Level 6, 447 Kent Street, Sydney, NSW	100.00	''	''
Timothy McMahan, 5 Florence St, Mentone	240.00	''	''
Elaine Mary McManus, 27/6 Buller Road, Artarmon, NSW	102.00	''	''
Kevin Bernard McManus, PO Box 87-503, Meadowbank, Auckland, New Zealand	110.00	''	''
Melanie Tara McMillan, 30 Brand Street, Hughes, ACT	100.00	''	''
Wares Anne McMillan, 751 Elizabeth St, Zetland, NSW	150.00	''	''
Sara Carson McMillan, 333 Nott St, Port Melbourne	100.00	''	''
Desmond J. McMillan, 41 O'Loughlan Street, Ormond	176.00	''	28/04/00
Desmond J. McMillan, 41 O'Loughlan Street, Ormond	220.00	''	27/10/00
Mr Alexander McMullen, 28 Lawler Street, Panania, NSW	163.15	''	28/04/00
McNair Pty Ltd, "McNair Family A/c", 53 Denbigh Road, Armadale	271.75	''	''
Kenneth Francis McNamara, "Superannuation Fund A/c", Banora Palms, 16 Darlington Drive, Banora Point, NSW	120.70	''	28/04/00
Kenneth Francis McNamara, "Superannuation Fund A/c", Banora Palms, 16 Darlington Drive, Banora Point, NSW	200.00	''	27/10/00
Sharon McNamara, "The CTRS Super Fund Account", 98 Guntawong Road, Rousehill, NSW	100.00	''	''
Mr Ian Maxwell McNaught & Mrs Christine Ann McNaught, 18 Wolger Street, Como West, NSW	100.00	''	''
Mrs Margaret McPhee, Aravia, Federal Drive, Eureka, NSW	100.00	''	''

McRoss Development No, 5 Pty Ltd, "Sharpies Golf Group ERF A/c", 220 Elizabeth Street, Sydney, NSW	110.00	"	"
Alan McSweeney, 32 Fitzgerald Road, Ermington, NSW	120.70	"	28/04/00
Mr Jeremy Michael McTigue, 37 Harricks Crescent, Attwood	100.00	"	27/10/00
Jann Denise McVicker & Peter James Fenaughty, 38 MacFarland Street, Brunswick	100.00	"	28/04/00
Jann Denise McVicker & Peter James Fenaughty, 38 MacFarland Street, Brunswick	125.00	"	27/10/00
Matthew James McWilliams, 23 Bradleys Head Road, Mosman, NSW	100.00	"	"
Kenneth V. Mead, 29 Miller Street, Waroona, QA,	144.95	"	28/04/00
Kenneth V. Mead, 29 Miller Street, Waroona, QA,	240.00	"	27/10/00
Miriam Meakin, 5 Cameron Close, Smithfield, Qld	100.00	"	"
Meca Holdings Pty Ltd, "Guerrera Super Fund Account", C/- V DeFrancesco, 210 Doncaster Ave, Kensington, NSW	458.15	"	28/04/00
Carol Dorothy Mechler & Frank Peter Mechler, 4 Kennedy Court, Mt Ommaney, Qld	100.00	"	27/10/00
Gary Ivan Medaris, 1/27 Crisp Circuit, Bruce, ACT	160.00	"	28/04/00
Diane Margaret Medaris, 1/27 Crisp Circuit, Bruce, ACT	160.00	"	"
Medley Park Pty Ltd, PO Box 124, Narre Warren North	120.70	"	"
Medley Park Pty Ltd, PO Box 124, Narre Warren North	200.00	"	27/10/00
Medsite Pty Ltd, 51 Milne Street, Templestowe	160.00	"	28/04/00
Peter John Meehan & Dianna Maree Hockins, 28 Chifley Crescent, Brassall Ipswich, Qld	250.00	"	27/10/00
Peter John Meehan, 28 Chifley Crescent, Brassall, Qld	250.00	"	"
Eric Mefflin, 12/7 Wallace Ave, Toorak	100.00	"	"
Megatop Nominees Pty Ltd, Unit Level 1, 30 The Esplanade, Perth, WA	138.00	"	"
Nandkishore Mehta, 5 Greenhill Crescent, St Ives, NSW	144.95	"	28/04/00
Nandkishore Mehta, 5 Greenhill Crescent, St Ives, NSW	240.00	"	27/10/00
Lalita Mehta, 5 Greenhill Crescent, St Ives, NSW	144.95	"	28/04/00
Nandkishore Mehta & Lalita Mehta, "Vrinda Mehta A/c", 5 Greenhill Cres, St Ives, NSW	140.00	"	27/10/00
Nandkishore Mehta & Lalita Mehta, "Mihir Mehta A/c", 5 Greenhill Crescent, St Ives, NSW	140.00	"	"
Wen Hui Mei, PO Box 230, Wentworthville, NSW	100.00	"	"
Marie Yan Mei, PO Box 230, Wentworthville, NSW	100.00	"	"
Mr Christopher Meikle, 59 Kent St, East Victoria Park, WA	210.00	"	"
Wayne Patrick Meissner, PO Box 12269, Brisbane, Qld	160.00	"	"
Mr Barry Melamed, Unit 92, 95-97 Grafton Street, Bondi Junction, NSW	250.00	"	"
Melatti Pty Ltd, "Ugo Melatti Family A/c", 8 Asti Court, Avondale Heights	362.00	"	"
Meldive Pty Limited, "Hansel & Gamble S/F No 2 A/c", C/- Madison Financial Group, Level 7, 140 Arthur Street, North Sydney, NSW	100.00	"	"
Dr Alexander Robert Meldrum, 278 William Street, Rockhampton, Qld	100.00	"	"
Ronald Gerrard Meldrum, 18 Fermoy Avenue, Lismore, NSW	100.00	"	"
Anthony Eugeneo Meleisea, 247 McMillan Road, Moil, NT	100.00	"	"
Mr Benjamin Melkman, 38 Chamberlain Avenue, Rose Bay, NSW	140.00	"	"

Mr Herman Melkman, 38 Chamberlain Avenue, Rose Bay, NSW	1,040.00	''	''
Audrey Mellor, 14/3 The Esplanade, Cronulla, NSW	100.00	''	''
John Mellor, 1 Florida Street, Sylvania, NSW	100.00	''	''
Priscilla Mendelson, 2/14 Ross Street, Toorak	100.00	''	''
Mr Jason Samuel Mendoza, Apartment 305, 45 Shelley Street, King Street Wharf, Sydney, NSW	162.00	''	''
Katherine Josefa Mendra & Josefa Mendra, 44 Cassandra Street, Chapel Hill, Qld	120.70	''	28/04/00
Katherine Josefa Mendra & Josefa Mendra, 44 Cassandra Street, Chapel Hill, Qld	200.00	''	27/10/00
Henry John Mendra, 44 Cassandra St, Chapel Hill, Qld	253.55	''	28/04/00
Henry John Mendra, 44 Cassandra St, Chapel Hill, Qld	420.00	''	27/10/00
Helen Meneer, 13/72 Macquarie Street, St Lucia, Qld	160.00	''	28/04/00
Helen Meneer, 13/72 Macquarie Street, St Lucia, Qld	200.00	''	27/10/00
Michael John Menegazzo, 210 River St, Deniliquin, NSW	280.00	''	''
Immanuel Mensik, PO Box 2925, Broome, WA	120.00	''	''
Valda Mentjox, 11 Horst Place, Mona Vale, NSW	100.00	''	''
Est Eugene Menyhart, C/- Macedone Christie Willis, PO Box 343, Jannali, NSW	420.00	''	''
Mr Graeme Alan Menzies, "Olivia Kate Menzies A/c", 19 Moorhouse Street, Armadale	100.00	''	''
Mr Peter Meredith, 14 Brandon Street, South Perth, WA	108.00	''	''
Angela Meriands, 22 Maitland Avenue, Kingsforen, NSW	180.00	''	''
William Gilbert Merlo & W. G. and R. A. Merlo Pty Ltd "Super Fund A/c", PO Box 371, Randwick, NSW	132.85	''	28/04/00
William Gilbert Merlo & W. G. and R. A. Merlo Pty Ltd "Super Fund A/c", PO Box 371, Randwick, NSW	220.00	''	27/10/00
Robert Merola, 27 Panorama Way, Point Cook	176.00	''	28/04/00
Merphil Pty Ltd, "Merphil Unit Trust A/c", 55 Pymble Avenue, Pymble, NSW	320.00	''	''
Merphil Pty Ltd, "Merphil Unit Trust A/c", 55 Pymble Avenue, Pymble, NSW	400.00	''	27/10/00
Kenneth Wayne Messner, 4 Faraday Rd, Croydon South	133.95	''	28/04/00
Kenneth Wayne Messner, 4 Faraday Rd, Croydon South	222.00	''	27/10/00
Meta Group Australia Pty Ltd, 3/3 Bellevue Park Road, Bellevue Hill, NSW	140.00	''	''
Mr Colin Maxwell Mettrick & Mrs Margaret Edna Mettrick, 10 Esta Street, Melton	100.00	''	''
Ms Rachel Susan Meyers, 4C Lynton Street, Mount Hawthorn, WA	100.00	''	27/10/00
Mr Paul Charles Mezei & Mrs Monique Justine Mezei, 3009 Hemlock Place, Wantagh, New York 11793 USA	144.00	''	28/04/00
Miami Beach Pty Ltd, Queen Street Chambers, 1/262 Queen Street, Melbourne	120.00	''	27/10/00
Nikki Miani, 8 Warrington Avenue, Epping, NSW	120.00	''	''
Steven Craig Michael, 38 Cardinal Avenue, Beecroft, NSW	128.00	''	28/04/00
Steven Craig Michael, 38 Cardinal Avenue, Beecroft, NSW	160.00	''	27/10/00
Malcolm George Michael, 38 Cardinal Ave, Beecroft, NSW	100.00	''	''

Michael Bar-Mordecai Pty Ltd, "Michael Bar-Mordecai SF A/c", 14/78 Wolseley Road, Point Piper, NSW	2,400.00	"	"
Mr George Michalczyk & Mrs Rita Berenice Michalczyk, "The GRM Super A/c", 30B Crawshaw Crescent, Manning, WA	600.00	"	"
Micheal Li Pty Ltd, "Super Fund A/c", C/- Powell Kwok & Co, Level 7, 350 Kent Street, Sydney, NSW	120.70	"	28/04/00
Michelene South Yarra Pty Ltd, 3/293 Bay Street, Brighton	120.00	"	27/10/00
Michelle Michelin, 1 Premier Street, Toongabbie, NSW MIDA Pty Ltd, "David Pinkus Super Fund A/c", 9 Liscard St, Elsternwick	100.00	"	"
Adam Paul Middleton, PO Box 139, Pennant Hills, NSW	350.00	"	"
Adam Paul Middleton, PO Box 139, Pennant Hills, NSW	120.70	"	28/04/00
Adam Paul Middleton, PO Box 139, Pennant Hills, NSW	200.00	"	27/10/00
Christopher Middleton-Williams, 11 Chalmers Avenue, Beacon Hill, NSW	100.00	"	"
Mr Shanan Anthony Mifsud, 7 Karnu Place, Kareela, NSW	100.00	"	"
Mr John Mihailidis, "Super Fund A/c", PO Box 1035, Carlton	100.00	"	"
Marie Mikkelsen, PO Box 12390, Elizabeth St, Brisbane, Qld	100.00	"	"
Anthony Martin Milbank, PO Box 139, Meadows, SA	144.95	"	28/04/00
Anthony Martin Milbank, PO Box 139, Meadows, SA	240.00	"	27/10/00
Zivorad Milenkovic, 127 Charles Street, Footscray	120.70	"	28/04/00
Zivorad Milenkovic, 127 Charles Street, Footscray	200.00	"	27/10/00
Robert Milici, 22 Willoughby Street, Reservoir	200.00	"	"
Dean Andrew Barry Miller & Suzanne Joy Mille, 34 Mount View Road, Upper Ferntree Gully	100.00	"	"
Chris K. Miller, PO Box 406, Mount Eliza	100.00	"	"
Ms Georgina Maree Miller, 5 Sewell Street, Box Hill North	100.00	"	"
Kieran Miller & Anna Leszkiewicz, 28 Loves Avenue, Oyster Bay, NSW	169.60	"	28/04/00
Kieran Miller & Anna Leszkiewicz, 28 Loves Avenue, Oyster Bay, NSW	212.00	"	27/10/00
Peter Miller, 5/34 Kensington Road, South Yarra	112.00	"	28/04/00
Mr Terry Miller, 19 May Street, Narrabri, NSW	108.00	"	27/10/00
Fay Y. Miller, Unit 5, 183 Brisbane Street, Bulimba, Qld	360.00	"	"
Carlee Lorraine Millikin, 1701/275 Alfred Street, North Sydney, NSW	257.00	"	"
Alison Mills, 9 Belair Street, Moorooka, Qld	100.00	"	"
Erina L. Millstead, 5 Wandoo Crescent, Wongan Hills, WA	128.00	"	28/04/00
Erina L. Millstead, 5 Wandoo Crescent, Wongan Hills, WA	160.00	"	27/10/00
Mr Mikimasa Minematsu 8S04 College Square, 550-590 Lygon Street, Carlton	100.00	"	"
Lim Choong Ming, 17 Unwin Crescent, Salter Point, WA	100.00	"	"
Joseph James Mingorance, 229 Wright Street, Adelaide, SA	297.60	"	28/04/00
Joseph James Mingorance, 229 Wright Street, Adelaide, SA	372.00	"	27/10/00
Mr Ivan Minks & Mrs Ina Minks & Miss Caroline Minks, 17 Mary Street, Spotswood	104.00	"	"
Garry Minner, PO Box 498, Sanderson, NT	120.00	"	"
Mr Michael Patrick Minogue, Unit 1106, 180 Ocean Street, Edgecliff, NSW	100.00	"	"

Miss Nadia Maria Minuzzo, 12 Jasper Street, Hyde Park, SA	192.00	”	28/04/00
Miss Nadia Maria Minuzzo, 12 Jasper Street, Hyde Park, SA	240.00	”	27/10/00
Mipa Printing Pty Ltd, “Mipa Printing S Fund A/c”, 33 Clapham Road, Regents Park, NSW	160.00	”	”
Estate of Vincent Miragliotta, “Est of Vincent Miragliotta”, 43 Reserve Rd, Annandale, NSW	138.90	”	28/04/00
Estate of Vincent Miragliotta, “Est of Vincent Miragliotta”, 43 Reserve Rd, Annandale, NSW	230.00	”	27/10/00
Mr Ian Mirels, 42 George Street, Dover Heights, NSW	100.00	”	”
Mirror Software Pty Limited, 64 Cobham Avenue, West Ryde, NSW	260.00	”	”
Mirror Software Pty Limited, 64 Cobham Avenue, West Ryde, NSW	260.00	”	”
Charumati Vijaykumar Mishra & Vijay Kumar Mishra, 18 Bowe Street, Shepparton	100.00	”	”
Brian Allan Mitchell, PO Box 172, Lakes Entrance	120.00	”	28/04/00
Brian Allan Mitchell & Helen Lorraine Mitchell, PO Box 172, Lakes Entrance	120.00	”	”
John Kenneth Mitchell, 3 Sturm Court, Oaklands Park, SA	100.00	”	27/10/00
Mr Scott Mitchell & Mr John Mitchell, PO Box 1311, South Melbourne	110.00	”	”
Ms Susan Mitchell, Unit 2, 252 Hope St, Brunswick West	100.00	”	”
Mr Matthew Philip Mitchell, Hong Kong Bank Australia Ltd, 118 Bundall Road, Bundall, Qld	100.00	”	”
Justin Paul Mitchell, 28 Montalto Avenue, Toorak	100.00	”	”
Tim Mitchell, 1/49 Whistler Street, Manly, NSW	120.70	”	28/04/00
Kenneth Maxwell Mitchell Snr, Unit 6, 62 Bridge Street, Epping, NSW	181.30	”	”
Kenneth Maxwell Mitchell Snr, Unit 6, 62 Bridge Street, Epping, NSW	300.00	”	27/10/00
Steven Mittas, 20 Lord Street, Bassemdeam, WA	200.00	”	”
Alastair Geoffrey Mitton, 27 Gregory Street, Ouyen	200.00	”	”
Nick Mixios, 11 Wharf Road, Kogarah Bay, NSW	144.00	”	28/04/00
Nick Mixios, 11 Wharf Road, Kogarah Bay, NSW	180.00	”	27/10/00
Martha Mixios, 11 Wharf Road, Kogarah Bay, NSW	100.00	”	”
Mr Michael Mjaskalo, Unit 20, 199 Walker Street, North Sydney, NSW	100.00	”	”
MME Investments Pty Ltd, 68 Styles Street, Leichhardt, NSW	100.00	”	”
Geoffrey Francis Mofflin, “Mofflin Family A/c”, PO Box 46, Kwinana, WA	128.00	”	28/04/00
Vahe Mofsessian & Annie Mofsessian, 24 Jimada Avenue, Frenchs Forest, NSW	134.40	”	”
Lisa Mohanlal, 181 MacDonnell Road, Margate, Qld	120.00	”	27/10/00
Mr Kam Yuk Mok, Unit 228, 20–34 Albert Road, Strathfield, NSW	100.00	”	”
Marinus F. Mol, 2 McCracken Street, Shepparton	232.00	”	28/04/00
Mr Antonino Mola & Mrs Narelle Mola, “Mola Super Fund A/c”, PO Box Z5413, St George’s Terrace, Perth, WA	112.00	”	”
Kelsey Scott Molenkamp, 62 Rickards Avenue, Knoxfield	100.00	”	27/10/00

Mrs Linda Ann Molineux, "L. & L. Molineux Family A/c", 11 Victoria St, Williamstown	242.40	"	28/04/00
Karin Moll, 9/15 Balfour Road, Rose Bay, NSW	100.00	"	27/10/00
Tracey Lee Molloy & Kym Brown, Lot 42, Treelands Drive, Jilliby, NSW	120.00	"	"
Ms Mary Therese Moloney, 7 Macken Street, Oatley, NSW	100.00	"	"
Kevin Molony & Yvonne Molony, 1/21 Rodewick Street, MacLean, NSW	120.00	"	"
Estate Francis William Molony, C/- Perpetual, 5th Floor, 39 Hunter Street, Sydney, NSW	200.00	"	"
Estate Francis Molony, C/- Perpetual, 5th Floor, 39 Hunter Street, Sydney, NSW	100.00	"	"
Peter Francis Monaghan, PO Box 44, Pendle Hill, NSW	260.00	"	"
Bridget Monaghan, PO Box 724, Traralgon	100.00	"	"
Parry Monckton, 38 Ashburton Avenue, Tarramarra, NSW	140.00	"	"
Sheila Siu Yee Mong, 1/14 Church Street, Ashfield, NSW	160.00	"	"
Jonah Monk, 156 Victoria Road, Bellevue Hill, NSW	271.75	"	28/04/00
Yeheskel Monk, 156 Victoria Road, Bellevue Hill, NSW	175.00	"	27/10/00
Keith William Monk, 10/41 Hanover Street, Fitzroy	200.00	"	"
Warren Stephen Monks, 18 Heydon Ave, Warrawee, NSW	160.00	"	28/04/00
Warren Stephen Monks, 18 Heydon Ave, Warrawee, NSW	200.00	"	27/10/00
Monterey Drive Pty Ltd, "Allan Jennings S/F A/c", PO Box 870, Belmont	181.30	"	28/04/00
Monterey Drive Pty Ltd, "Allan Jennings S/F A/c", PO Box 870, Belmont	300.00	"	27/10/00
Monterey Drive Pty Ltd, PO Box 870, Belmont	241.45	"	28/04/00
Monterey Drive Pty Ltd, PO Box 870, Belmont	400.00	"	27/10/00
Dennis William Montgomery & Beverly Lillian Montgomery, 17 Parkhill Crescent, Cherrybrook, NSW	100.00	"	"
MR Peter Moon, 11 Riversdale Court, Hawthorn	200.00	"	"
Mr Anthony John Mooney & Ms May Ho, 60 Warraroong Street, Beverly Hills, NSW	100.00	"	"
Rosa Moore & Peter Moore, 91 Dover Road, Dover Heights, NSW	100.00	"	"
Ms Virginia Ann Moore & Mr Daniel Ross Moore & Ms Olivia Jayne Moore, 39 Donald Road, Wheelers Hill	176.00	"	28/04/00
Kenneth Alfred Moore, 36 Anora Crescent, Mulgrave	140.00	"	27/10/00
Mr Mark Craig Moore & Ms Trinity Anne Quinn, 11 Tuga Place, Glenmore Park, NSW	100.00	"	"
John Moore, 611 Tower Road, Bankstown, NSW	160.00	"	28/04/00
John Moore, 611 Tower Road, Bankstown, NSW	200.00	"	27/10/00
Barbara Moore, 62a Malsbury Rd, Normanhurst, NSW	160.00	"	"
Florence Moore, 6 Dalton Road, Mosman, NSW	127.90	"	28/04/00
Florence Moore, 6 Dalton Road, Mosman, NSW	212.00	"	27/10/00
Peter Kevin Moore, 229 Rotary Park Road, Alberton, Qld	100.00	"	"
Ms Rosa Marie Moore, "Phillip/Alicia/David A/c", 44 Newcastle Street, Rose Bay, NSW	100.00	"	"
Ms Susan Mary Angela Moore, 78 Watson Street, Wilston, Qld	100.00	"	"
Mr Lester Anaru Moore, 17 Martin Avenue, St Lukes, Auckland, New Zealand	130.00	"	"

Mr Robert John Moore & Mr Simon Andrew Moore, "Prahran Investments A/c", 3 Atkinson Close, Prahran	301.55	"	28/04/00
Rajan Nanthan Moorthy, 5 Lytton Street, Elwood	137.80	"	"
Rajan Nanthan Moorthy, 5 Lytton Street, Elwood	228.00	"	27/10/00
Moraca Holdings Pty Ltd, "Super Fund A/c", PO Box 941, Darlinghurst, NSW	181.30	"	28/04/00
Moraca Holdings Pty Ltd, "Super Fund A/c", PO Box 941, Darlinghurst, NSW	300.00	"	27/10/00
Mr John Leith Moran, 5 Kingston Terrace, North Adelaide, SA	120.00	"	"
Lisa Karen Mordecai, 705 Old South Head Road, Vaucluse, NSW	150.00	"	"
Mr Dean P. Morelli, 28 Jane Street, Balmain, NSW	288.00	"	28/04/00
Wayne Dennis Morey, 42 Warburton Avenue, Padbury, WA	100.00	"	27/10/00
Judy Morgan, 51 John Street, Rosewood, Qld	240.00	"	"
Mr William Henry Morgan & Mrs Nada Morgan, 12 Fossickers Crt, Gympie, Qld	100.00	"	"
John C. Morgan, C. & G. Service—Sydney Region, Locked Bag 6, Sydney Locked Bags, NSW	151.00	"	28/04/00
John C. Morgan, C. & G. Service—Sydney Region, Locked Bag 6, Sydney Locked Bags, NSW	250.00	"	27/10/00
Morinia Pty Ltd, 43 Vernon Street, Spotswood	186.00	"	"
Kenan Morkaya, 45 Ann Street, Enfield, NSW	120.00	"	28/04/00
Kenan Morkaya, 45 Ann Street, Enfield, NSW	150.00	"	27/10/00
Gary Morley, 38 Sprigg Place, Mount Colah, NSW	112.00	"	"
Thomas Charles Morris, 16 Greenhill Road, Selby	100.00	"	"
John Riviere Morris, 48 Harrow Road, College Park, SA	100.00	"	"
Antoinette Juliet Morris, 17 Hawkins Road, Roleystone, WA	120.00	"	"
Ms Valerie Elaine Morris, 20 Cobby St, Campbell, ACT	140.00	"	"
Mr Athol Anzac Morris, 20 Cobby St, Campbell, ACT	112.00	"	28/04/00
Michelle Ann Morrison, 6 Wallace Road, Burwood	120.70	"	"
Michelle Ann Morrison, 6 Wallace Road, Burwood	200.00	"	27/10/00
Phillip Patrick Morrison, Green Cables, Galong, NSW	100.00	"	"
Ian Morrison, "Superannuation Fund A/c", 15 Australis Circuit, Port Melbourne	100.00	"	"
Mr Gregory Peter Morrison, 42 Victoria Street, Smithfield, NSW	100.00	"	"
Ms Irene Yvonne May Morriss, PO Box 372, Matraville, NSW	100.00	"	"
James Ernest Morrow & Joy Morrow, 14 Moloki Avenue, Chittaway Bay, NSW	205.60	"	28/04/00
James Ernest Morrow & Joy Morrow, 14 Moloki Avenue, Chittaway Bay, NSW	257.00	"	27/10/00
Morse Corporation Australia Pty Ltd, 97 Wattle Street, Punchbowl, NSW	200.00	"	"
Morse Technology Pty Ltd, 97 Wattle Street, Punchbowl, NSW	120.00	"	"
Stuart Mortimer & Rosalind Ann Mortimer, 53 Ridgway Drive, Flagstaff Hill, SA	100.00	"	"
Mr Bradley Mortimer, 4 Goodier Place, Kenthurst, NSW	110.00	"	"
Barrie Charles Morton & Wilma Martha Morton, 398 Jackson Road, Sunnybank Hills, Qld	120.00	"	"

Glenn Barrie Morton, 398 Jackson Road, Sunnybank Hills, Qld	100.00	''	''
Leighton Morvell, 3 Kings Street, Swan Hill	100.00	''	''
Sylvia Barbara Moses & Arthur Raymond Moses, 173 Thompson Street, Drummoyne, NSW	100.00	''	''
Louis Hendrik Mostert, 46 The Esplanade, Peppermint Grove, WA	120.00		''
Motet Consulting Pty Ltd, Attn Mark Maddocks, 86 Bradleys Lane, Warrandyte	100.00	''	''
Tuin Wesley Mott, C/- Dalby South State School, Owen Street, Dalby, Qld	100.00	''	''
Mottura Pty Ltd, C/- Carlo Licciardi, 123/299 Queen Street, Melbourne	108.00	''	''
Ian James Mould, 6/34 Broughton Avenue, Mitcham, SA	100.00	''	''
Ian James Mould & Mary Davidson Mould, 6/34 Broughton Avenue, Mitcham, SA	100.00	''	''
Susan Edith Mountain & Dennis John Mountain, 95 Astons Road, Yarrambat	110.00	''	''
Mowby Pty Ltd, 12 Hanslope Avenue, Alphington	188.00	''	''
Mr Michael Anthony Moye, Unit 76, 6-14 Oxford Street, Darlinghurst, NSW	200.00	''	''
Mrs Susette Patricia Moylan, PO Box 1102, Nedlands, WA	292.00	''	''
Lindsay Veronica Mozley, PO Box 2993, Alice Springs, NT	150.00	''	''
Mr Kenton Neale May & Mrs Vicky May, 13 Wattletree Road, Armadale	330.00	''	''
Ms Caroline Hirst, 38 Wilden Street, Paddington, Qld	100.00	''	''
MSGS Pty Ltd, MC 6123 SCMC, Wollongong, NSW	212.00	''	''
Christopher John Martin Mugdan, 7 Innes Avenue, Hornsby, NSW	140.00	''	''
Mrs Stephanie Ann Mugglestone, 54 Moore Street, Roseville, NSW	160.00	''	28/04/00
Mrs Stephanie Ann Mugglestone, 54 Moore Street, Roseville, NSW	200.00	''	27/10/00
Simon Mui, 18 Davis Street, Kew	120.00	''	''
Patty Mui, 18 Davis Street, Kew	120.00	''	''
James Fulton Muir, RMB 341, Sutton Road, Queanbeyan, NSW	150.00	''	''
Mrs Katheryn Macewan Muir, Unit 2, 29 Liston Street, Nambucca Heads, NSW	100.00	''	''
Christopher James Mulcahy, 8 Gooraway Drive, Castle Hill, NSW	120.70	''	28/04/00
Mr Christopher James Mulcahy, 8 Gooraway Drive, Castle Hill, NSW	120.70	''	''
Christopher James Mulcahy, 8 Gooraway Drive, Castle Hill, NSW	120.70	''	''
Justin Mulder, 17 Willoby Ave, Glen Iris	100.00	''	27/10/00
Thomas Mullins, 78 Rawdon Hill Dr, Dandenong North	100.00	''	''
Giovani Multari, "Gerace Multari Family A/c", 10 Fairfield Street, Mount Hawthorn, WA	120.00	''	''
Robert Joseph Kok Yien Mun, 56 Churchill Road, East Killara, NSW	100.00	''	''
Muni Contractors Pty Ltd, 235 Nicholson Street, Brunswick East	108.00	''	''

Joanne Munn, PO Box 473, Newcastle, NSW	150.00	''	''
Clare Munro, 8 Williams Road, Mornington	220.00	''	''
Mrs Marie Joan Murdoch, PO Box 1651, Brisbane, Qld	140.00	''	''
Murdoch Associates Pty Ltd, "Murdoch Assoc S/F A/c", PO Box 487, Mosman, NSW	1,010.40	''	28/04/00
Murdoch Associates Pty Ltd, "Murdoch Assoc S/F A/c", PO Box 487, Mosman, NSW	1,263.00	''	27/10/00
Colin Edward Murphy, 12 Woodlands Rd, Liverpool, NSW	100.00	''	''
Jillian Murphy, 11/92 Shirley Road, Wollstonecraft, NSW	160.00	''	28/04/00
Mr Peter David Murphy, C/- White McIntyre & Co, Chartered Accountants, PO Box 1155, Chatswood, NSW	100.00	''	27/10/00
Mr Paul Murphy, 2 Windsor Place, Kallaroo, WA	100.00	''	''
Stuart Murphy, Unit 3, 52 Leicester Street, Carlton	169.60	''	28/04/00
Stuart Murphy, Unit 3, 52 Leicester Street, Carlton	212.00	''	27/10/00
Tyson Noel Murphy, RMB 4370, Maffra	160.00	''	28/04/00
Mr Anthony Michael Murphy, Unit 12, 1 Bramble Terrace, Red Hill, Qld	100.00	''	27/10/00
Ms Roseanne Murphy, 31A Marks Street, Naremburn, NSW	100.00	''	''
Ms Helen Margaret Murray, PO Box 3554, Manuka, ACT	140.00	''	''
Ann Murray, 18 Flowerdale Road, Moorabbin	112.00	''	28/04/00
Mr Grahame Roy Murray & Mr Ronald Murray, "Murrays Retirement Fund A/c", PO Box 61, Moorebank, Nsw	150.00	''	27/10/00
Dr Saroj Murthy, 24/132 Coreen Avenue, Penrith, NSW	160.00	''	28/04/00
Dr Saroj Murthy, 24/132 Coreen Avenue, Penrith, NSW	200.00	''	27/10/00
Mr Peter Robert Musk, 122 Oceanside Promenade, Mullaloo, WA	100.00	''	''
Muskland Investments Pty Ltd, "Lewis-Moloney A/c", 1006a Armstrong St, Ballarat North	140.00	''	''
Patricia H. Mutch, 40 Raff Street, Toowoomba, Qld	110.00	''	''
Vanaja Muthurajah, 1/6 Redmyre Road, Strathfield, NSW	250.00	''	''
Mutual Property Securities Pty Ltd, 464 Bell Street, Pascoe Vale South	108.60	''	28/04/00
Mutual Property Securities Pty Ltd, 464 Bell Street, Pascoe Vale South	180.00	''	27/10/00
Mutual Trust Pty Ltd, "Barnes Family A/c", PO Box 12, Collins Street West	112.00	''	28/04/00
Mutual Trust Pty Ltd, "Barnes Family A/c", PO Box 12, Collins Street West	140.00	''	27/10/00
Martyn Myer & Jane Westerman, L/55 Collins Street, Melbourne	308.00	''	28/04/00
Martyn Myer & Jane Westerman, L/55 Collins Street, Melbourne	385.00	''	27/10/00
Raymond Barry Myers, Social Science CSU, Bathurst, NSW	200.00	''	''
Janet Myers, 38 Calembeena Avenue, Oakleigh	307.60	''	28/04/00
Janet Myers, 38 Calembeena Avenue, Oakleigh	510.00	''	27/10/00
Paul B. Mylon, 13 Hallawell Crescent, Wodonga	110.00	''	''
Mynee Investments Pty Ltd, 2 Glenann Court, Boronia	100.00	''	''
Beata Mytkowsri, 113 Deakin Street, Silverwater, NSW	100.00	''	''
Adam Nable, 18C Pine Ave, Brookvale, NSW	137.60	''	28/04/00
Kiril Nacovski, 42 Richmond Street, Rockdale, NSW	252.80	''	''
Mahnaz Naderi, "William Reza Naderi A/c", 16 Warrabri Place, Pymble, NSW	120.00	''	27/10/00

Nader Naderi, "Sarah Naderi A/c", 16 Warrabri Place, Pymble, NSW	120.00	"	"
Mrs Nayoma Nagahawatta, Unit 16, 26 Harold Street, North Parramatta, NSW	100.00	"	"
Mrs Nayoma Nagahawatta, "Hiran Nagahawatta A/c", Unit 16, 26 Harold Street, North Parramatta, NSW	100.00	"	"
Nagari Venture Pty Ltd, "Montego Azure Superannu A/c", 6 Hudson Ave, Willoughby, NSW	120.00	"	"
Miss Arathi Naidu, PO Box 26, Crown Street, Surry Hills, NSW	190.00	"	"
Damodran Nair, Lot 126, Merriwa Ave, Hoxton Park, NSW	100.00	"	"
Denise Nakis, 153 Doncaster Road, North Balwyn	140.00	"	"
Mr Andrew Nandan, PO Box 2193, Templestowe Heights	280.00	"	28/04/00
Mr John W. Napier, 11 Marmion Street, Birrong, NSW	200.00	"	"
Napier Developments Pty Ltd, "Super Fund A/c", PO Box 207, Spit Junction, NSW	200.00	"	27/10/00
Anthony Napoleone, 3 Kell Place, Templestowe	233.60	"	28/04/00
Anthony Napoleone, 3 Kell Place, Templestowe	292.00	"	27/10/00
Mr Raffaele Nardella, 671 Heidelberg Road, Alphington	120.00	"	"
Joan Nardella & Antonio Nardella, 80 Saunders St, Coburg	112.00	"	28/04/00
Naseby Pty Ltd, PO Box 527, Canberra, ACT	288.00	"	"
Naseby Pty Ltd, PO Box 527, Canberra, ACT	360.00	"	27/10/00
Geoffrey Gabriel Nash & Vicki Nash, The Parapet, Castlecrag, NSW	200.00	"	28/04/00
Geoffrey Gabriel Nash & Vicki Nash, The Parapet, Castlecrag, NSW	250.00	"	27/10/00
David William Nash, 22 Wharf Road, Kogarah Bay, NSW	150.00	"	"
Adrian Nash, 199 Owen Dixon Drive, Spence, ACT	120.00	"	"
Tegan Nash, 17/3367 Edmund Rice Drive, Southport, Qld	100.00	"	"
Kathleen Nash, 11 Lander Crescent, Amaroo, ACT	128.00	"	28/04/00
Kathleen Nash, 11 Lander Crescent, Amaroo, ACT	160.00	"	27/10/00
Adrian Nash, "Justin Adrian Phillip Nash A/c", 199 Owen Dixon Drive, Spence, ACT	128.00	"	28/04/00
Adrian Nash, "Justin Adrian Phillip Nash A/c", 199 Owen Dixon Drive, Spence, ACT	160.00	"	27/10/00
Adrian Nash, "Beau Marcus William Nash A/c", 199 Owen Dixon Drive, Spence, ACT	128.00	"	28/04/00
Adrian Nash, "Beau Marcus William Nash A/c", 199 Owen Dixon Drive, Spence, ACT	160.00	"	27/10/00
Figaro Natoli & Angela Jane Natoli,, 132 Ross Street, Wanneroo, WA	128.00	"	28/04/00
Mr Brian John Naughton, 108 Nemarang Crescent, Waramanga, ACT	160.00	"	27/10/00
Robert Naumov, 17 Eddy Street, Hamilton, NSW	160.00	"	28/04/00
Paul Christopher Naylor, 3/247 Riversdale Road, Hawthorn	101.40	"	"
Paul Christopher Naylor, 3/247 Riversdale Road, Hawthorn	168.00	"	27/10/00
Ruth Naylor, 56 Bates Street, Strathfield, NSW	100.00	"	"
Margaret Naylor, 56 Bates Street, Strathfield, NSW	160.00	"	"
Geoffrey Naylor, 56 Bates Street, Strathfield, NSW	100.00	"	"
Bruce Naylor, 56 Bates Street, Strathfield, NSW	100.00	"	"
Donna M. Neal, 29/39 Gibbons Street, Redfern, NSW	151.00	"	28/04/00
Donna M. Neal, 29/39 Gibbons Street, Redfern, NSW	250.00	"	27/10/00

Mr Uriy Nechtcheroov, Unit 24, 7 Bolshaya Street, Khabarovsk 68009 Russian Federation	135.00	''	''
Mark Leonard Neeson, Box 563, Leeton, NSW	140.00	''	''
Kerry Elizabeth Negara, 58 Marine Parade, Elwood	212.64	''	28/04/00
Yoshitomo Negishi & Keiko Ozasa & Ryo Negishi, 126/421 Pacific Highway, Artarmon, NSW	240.00	''	27/10/00
Paul Negline, GPO Box 4983ww, Melbourne	100.00	''	''
Phillip David Nehmy & "Est N. G. Nehmy A/c", 1/410 Carrington Street, Adelaide, SA	160.00	''	''
Kenneth Leslie Neilson & Joan Lorraine Neilson, 3 Anthony Drive, Mount Waverley	120.00	''	28/04/00
Mr Jonathan Richard Nell, 95 Awaba St, Mosman, NSW	100.00	''	27/10/00
David John Nelligan, PO Box 210, Maitland, SA	200.00	''	''
William Alfred Nelson, PO Box 1254, Nhulunbuy, NT	100.00	''	''
Raquel Jane Nelson, PO Box 488, Newman, WA	100.00	''	''
Ms Joan Nelson, 21 Warragal Road, Turrumurra, NSW	100.00	''	''
David Sebastian Nelson, 2 Fishers Lane, Fitzroy	112.00	''	28/04/00
Catherine Andrea Nelson, PO Box 426, Mount Eliza	100.00	''	27/10/00
Mr John Nettleton, "Toby Nettleton A/c", 7 Clifton Street, Richmond	100.00	''	''
Networks R Us Pty Ltd, Unit 1/28 Alan Street, Cammeray, NSW	120.70	''	28/04/00
Networks R Us Pty Ltd, Unit 1/28 Alan Street, Cammeray, NSW	200.00	''	27/10/00
Neutral Bay Optical Pty Ltd, "Super Fund A/c", 91 Dover Road, Dover Heights, NSW	132.85	''	28/04/00
Neutral Bay Optical Pty Ltd, "Super Fund A/c", 91 Dover Road, Dover Heights, NSW	220.00	''	27/10/00
Ms Belinda Anne Nevell, 19 Carlotta St, Greenwich, NSW	360.00	''	''
Naomi Neville, Eramosa Lodge, 216 Eramosa Road, Somerville	100.00	''	''
David Neville, 58 Magenta Square, Amaroo, ACT	100.00	''	''
Mr Abe New, 1373 President St, Brooklyn NY 11213 USA	110.85	''	28/04/00
Mr Patrick John Newcombe & Mrs Elaine Bernadette Newcombe, 6 Seville Pde, Orange, NSW	120.70	''	28/04/00
Kenneth Albert Newman & Nancy Maie Newman, 138 Darlington Drive, Banora Point, NSW	160.00	''	''
Kenneth Albert Newman & Nancy Maie Newman, 138 Darlington Drive, Banora Point, NSW	200.00	''	27/10/00
Lisa Newman, Unit 04-181 Treetops Executive Residences, 7 Orange Grove Road, Singapore 258355	100.00	''	''
Lisa Newman, "The Newman Exec S/ Fund A/c" Unit 04-181 Treetops Executive Residences, 7 Orange Grove Road, Singapore 258355	200.00	''	''
Charles Roy Newman & Elizabeth Cameron Newman, "Cr & Ec Newman A/c", 7 Burke Street, Toowoomba, Qld	100.00	''	''
Mr Vikrant Kunar Newnaha, 14 Stuart St, Blakehurst, NSW	108.00	''	''
Beverley Anne Newton & Leonard John Newton, 14 Edward Street, Macleod	100.00	''	''
Mr James David Newton, PO Box 383, Scarborough, WA	380.00	''	''
Mr Gareth Newton, Top Maisonette, 24 Narcissus Road, West Hampstead, United Kingdom	100.00	''	''

Danny Ng & Teresa Ng, 158 The Esplanade, Sylvania, NSW	100.00	''	''
Doris Ng, 10 Kindelan Road, Winston Hills, NSW	182.00	''	''
Felix King Lam Ng & Gary King Sum Ng, 50/82 Daw Road, Runcorn, Qld	100.00	''	''
Teresa Ng, 158 The Esplanade, Sylvania Heights, NSW	280.00	''	''
Shen Chai Ng, 190 Riseley Street, Booragoon, WA	100.00	''	''
Julian Ng, 29 Kimberley Way, Parkwood, WA	141.90	''	28/04/00
Julian Ng, 29 Kimberley Way, Parkwood, WA	235.00	''	27/10/00
Wai Khuin Ng, 16 Conran Avenue, Endeavour Hills	100.00	''	''
Ms Geok Hua Ng, 17 Isabella Crescent, Manning, WA	1,386.50	''	28/04/00
Ms Geok Hua Ng., 17 Isabella Crescent, Manning, WA	2,300.00	''	27/10/00
Candy Yuk Sum Ng, "Lawrence Trinh A/c", 57a Boyd Street, Cabramatta West, NSW	160.00	''	28/04/00
Candy Yuk Sum Ng, "Lawrence Trinh A/c", 57a Boyd Street, Cabramatta West, NSW	200.00	''	27/10/00
Tee Chuan Ng, 76 The Avenue, Nedlands, WA	108.00	''	''
Mr Raymond Ng, Unit 6A, 300 Marsden Road, Carlingford, NSW	100.00	''	''
Sun Oh Ng, C/- Chartpac Securities Ltd, PO Box Y3046, Perth, WA	100.00	''	''
Mr Phillip Cheng Hock Ng, C/- 1 Science Centre Road, Mcdermott Sth East Asia Pte Ltd 609077	110.85	''	28/04/00
Mr Phillip Cheng Hock Ng, C/- 1 Science Centre Road, Mcdermott Sth East Asia Pte Ltd 609077	150.00	''	27/10/00
Ms Geok Hua Jean Ng, 17 Isabella Crescent, Manning, WA	301.55	''	28/04/00
Ms Geok Hua Jean Ng, 17 Isabella Crescent, Manning, WA	500.00	''	27/10/00
Mr Koon Ying Ng, 24 Kingsland Road, Strathfield, NSW	181.30	''	28/04/00
Mr Sau Foong Ng, 10 2th Floor Jalan Ghazali Jawi 31400 Ipoh Perak Derui Ridzuan, Malaysia	256.00	''	''
Mr Mun Ngai, PO Box 706, Belconnen, ACT	120.00	''	27/10/00
Michael Anthony Nguyen & Cecilia Nguyen, 19 Edward Street, Silkwood North, Qld	100.00	''	''
Vuong V. Nguyen & Lechi T. Nguyen, 33 Yarrinup Avenue, Chadstone	100.00	''	''
Tuan Dinh Nguyen, 37 Avondale Street, Springvale	133.28	''	28/04/00
Stephanie Nguyen, 59 Vega Street, Revesby, NSW	100.00	''	27/10/00
Mrs Dung Cong Thi Nguyen, 83 Elizabeth Street, Richmond	100.00	''	''
Mr Andrew Charles Nicholas, 34 Darling Point Road, Darling Point, NSW	192.00	''	28/04/00
Mr Andrew Charles Nicholas, 34 Darling Point Road, Darling Point, NSW	240.00	''	27/10/00
Timothy Michael Nicholas, 220 Domain Road, South Yarra	150.00	''	''
Amber Eugenie Nicholas, 220 Domain Road, South Yarra	160.00	''	''
Ms Coleen Therese Nichols, C/- Mitchell & Partners, Level 7, 309 Kent Street, Sydney, NSW	120.70	''	28/04/00
Ms Coleen Therese Nichol, C/- Mitchell & Partners, Level 7, 309 Kent Street, Sydney, NSW	200.00	''	27/10/00
Carole Judith Nicholson, 24 Simpson St, Applecross, WA	100.00	''	''
Andrew William Nicholson, 137/19 Herbert Street, St Leonards, NSW	257.60	''	28/04/00
Petrina Alexandra Nicklin, PO Box 291, Collaroy, NSW	100.00	''	27/10/00
Jill Nicks & Trevor Raymond Nicks, 36 Oakridge Rise, Hackham West, SA	100.00	''	''

Mr Michael Nicolaou & Mrs Rita Nicolaou, 39 Smith Street, Wentworthville, NSW	240.00	''	''
Chris Nicolaou, 2/43 Osborne Road, Manly, NSW	100.00	''	''
Leon Nicolas, "Alexandra Nicolas", 12 Desay Marez Street, Kensington Park, SA	148.00	''	''
Rachel Nicolas, 12 Desaumarez St, Kensington Park, SA	118.40	''	28/04/00
Rachel Nicolas, 12 Desaumarez St, Kensington Park, SA	148.00	''	27/10/00
Leon Nicolas, "Michaela Nicolas A/c", 12 Desaumarez Street, Kensington Park, SA	148.00	''	''
Nikath Pty Ltd, 243 Main Road, Blackwood, SA	227.40	''	28/04/00
Nikath Pty Ltd, 243 Main Road, Blackwood, SA	377.00	''	27/10/00
Nikath Pty Ltd, S 4 H 243 Main Rd, Blackwood, SA	530.00	''	''
Mr Joshua Stuart John Niland, 70 Beresford Road, Rose Bay, NSW	141.20	''	28/04/00
Terrence Nilon, 1/83 Dolphin Street, Coogee, NSW	288.00	''	''
Terrence Nilon, 1/83 Dolphin Street, Coogee, NSW	360.00	''	27/10/00
Mr Frederich Reinhard Niproschke, 2/A Duncen Street, Arncliffe, NSW	102.40	''	28/04/00
Nisha Nominees Pty Limited, "Investment Fund A/c", 10/49 Bay Road, Waverton, NSW	1,278.64	''	''
Nisha Nominees Pty Limited, "Investment Fund A/c", 10/49 Bay Road, Waverton, NSW	1,598.30	''	27/10/00
Nisha Nominees Pty Limited, "Investment Fund A/c", 10/49-51 Bay Road, Waverton, NSW	399.04	''	28/04/00
Nisha Nominees Pty Limited, "Investment Fund A/c", 10/49-51 Bay Road, Waverton, NSW	498.80	''	27/10/00
Ms Veronica June Nix, RMB 133, Boyup Brook, WA	224.00	''	''
Kevin Joseph Nixon, 11 Tench Rise, Endeavour Hills	130.00	''	''
Vilma Nixon, 1/11 Tench Rise, Endeavour Hills	130.00	''	''
Estate Jericho Nkala, 24 Traminer Place, Minchinbury, NSW	100.00	''	''
Mr Bernie No, 62 Hunter Street, Strathfield, NSW	100.00	''	''
Richard John Noack, 23 Bowden Grove, Oaklands Park, SA	100.00	''	''
Nodius Pty Ltd, "McMahon A/c", 29 Rochester Way, Dianella, WA	100.00	''	''
Kathryn Patricia Nolan, 73 Buller Street, North Parramatta, NSW	200.00	''	''
Ruan Perera & Nominee & Rachel Perera & Nominee, 106 Henley Marine Drive, Drummoyne, NSW	100.00	''	''
Mrs Jan Elizabeth Noonan, Unit 1, 39 Augustine Street, Hunters Hill, NSW	160.00	''	''
Norcam Pty Ltd, 15 Jordan Terrace, Bowen Hills, Qld	100.00	''	''
Nork Environment Services Pty Ltd, PO Box 522, Kew	140.00	''	''
Richard Norris, 16 Achilles Ave, North Wollongong, NSW	168.00	''	28/04/00
Ms Christine Norris & Mr Trevor Norris, "The Norris Super Fund A/c", 20 Yarawindi Drive, Orange, NSW	112.00	''	''
Ms Christine Norris & Mr Trevor Norris, "The Norris Super Fund A/c", 20 Yarawindi Drive, Orange, NSW	140.00	''	27/10/00
Kerry Lee Ann Norris, 6 Nemba, Hunters Hill, NSW	118.40	''	28/04/00
Kerry Lee Ann Norris, 6 Nemba, Hunters Hill, NSW	148.00	''	27/10/00
Mr John Phillip Norriss, 314 Alexander Drive, Dianella, WA	400.00	''	''

Mr John Phillip Norriss, C/- Yacht "Windwalker", PO Box 4065, St Thomas USA 00803, Virgin Islands	135.60	"	28/04/00
Bruce Alan North, PO Box 259, Laurieton, NSW	100.00	"	27/10/00
Est Philip James North, C/- Perpetual Registrars Ltd, PO Box 1736P, Melbourne	100.78	"	28/04/00
Est Philip James North, C/- Perpetual Registrars Ltd, PO Box 1736P, Melbourne	166.60	"	27/10/00
North Star Australia Pty Ltd, 11 Carrington Road, Indooroopilly, Qld	100.00	"	"
Rhondah E Northrope, 32 Gordon Grove, Preston	166.00	"	"
Mary Alice Norton, RMB 4141A, Tallangatta	100.00	"	"
November 1998 Pty Ltd, "Crowhurst Super Fund A/c", 4 Woolner Court, Hawker, ACT	120.00	"	"
Richard Nowak, 66 Northcote Road, Armadale	150.00	"	"
Ns Nominees Pty Ltd, 11 Gordon Street, West Perth, WA	250.00	"	"
Mr John Vincent Nugent, 239 Ballina Road, Goonellabah, NSW	382.00	"	"
Mr Luigi Nunzio, "L&L Nunzio Family Trust A/c", 48 River Drive, Athelstone, SA	100.00	"	"
Stephen John Nutt & Patricia Margaret Nutt, 14 Sauls Road, Mandalong, NSW	200.00	"	"
Jennifer Nye, 6/41 Shelley Street, Elwood	140.00	"	"
Agnes Nyerges & John A. Daly, 71 Pioneer Street, Sheldon, Qld	120.00	"	"
Nyleeta Superannuation Fund, Number Two Account, Lot 111, Wattleup Road, Watt Leup, WA	100.00	"	"
Mr Sean O'Brian, 9 Oakey Creek Road, Hall, ACT	100.00	"	"
Samantha Jane O'Brien, 19/671 Brunswick Street, New Farm, Qld	150.00	"	"
Donna O'Brien & Rory Chapple, Unit 7, 23A Fourth Street, Katherine, NT	120.00	"	28/04/00
Mr David Anthony O'Brien, 28 Sunnymeade Close, Asquith, NSW	112.00	"	"
Mr Jason Vincent O'Brien, 499 Main Western Road, Tamborine, Qld	188.00	"	"
Mr Noel Francis O'Brien, PO Box 760, Pymble, NSW	301.55	"	"
David John O'Connell, 21 William Road, Klemzig, SA	120.70	"	"
David John O'Connell, 21 William Road, Klemzig, SA	120.70	"	"
David John O'Connell, 21 William Road, Klemzig, SA	120.70	"	"
Timothy James O'Connell & Liliane O'Connell, 26 Newcastle Street, Morisset, NSW	100.00	"	27/10/00
Daisy Irene O'Connell & Leonard John O'Connell, A/80 Zenobia Street, Palmyra, WA	100.00	"	"
Patrick O'Connor, 21 Stephenson St, Wulguru Townsville, Qld	120.70	"	28/04/00
Mark O'Connor, 11/124 Caroline Street, South Yarra	200.00	"	27/10/00
Daniel Pdraig O'Connor & Patrick Liam O'Connor & Siobhan Cait O'Connor, 33 Yangoora Place, Greenborough	100.00	"	"
Patrick James O'Connor, "O'Connor Family A/c", 21 Stephenson Street, Wulguru, Qld	120.70	"	28/04/00
Duane Patrick O'Connor, "O'Connor Family A/c", 21 Stephenson Street, Wulguru, Qld	144.95	"	"

Pat O'Connor & Duane O'Connor, "O'Connor Family A/c", 21 Stephenson St, Wulguru, Qld	217.20	"	"
Duane O'Connor & Pat O'Connor, "O'Connor Family A/c", 21 Stephenson St, Wulguru, Qld	217.20	"	"
Duane Patrick O'Connor & Patrick James O'Connor, "O'Connor Family A/c", 21 Stephenson St, Wulguru, Qld	144.95	"	"
Mr Philip John O'Connor, "O'Connor Ltc S/F A/c", 6 Walter Street, Mortdale, NSW	100.00	"	27/10/00
Dr Anne Evelyn O'Donnell, 79/1 Wigram Lane, Glebe, NSW	144.95	"	28/04/00
Dr Anne Evelyn O'Donnell, 79/1 Wigram Lane, Glebe, NSW	240.00	"	27/10/00
Lisa O'Donoghue, 14 Garvary Street, Holland Park, Qld	180.00	"	"
Mr John K O'Donohue, 30 Hannan Street, Williamstown	190.00	"	"
Miss Megan O'Dwyer, 158 Cecil Street, Williamstown	100.00	"	"
Justin James O'Farrell, 8 Greenwich Rd, Greenwich, NSW	296.00	"	28/04/00
Justin James O'Farrell, 8 Greenwich Rd, Greenwich, NSW	370.00	"	27/10/00
Stephen Gregory O'Hair, 109 Jeffcott Street, North Adelaide, SA	120.70	"	28/04/00
Stephen Gregory O'Hair, 109 Jeffcott Street, North Adelaide, SA	200.00	"	27/10/00
Ms Louise O'Hara, 21 Willoughby Street, Kirribilli, NSW	102.00	"	"
Margaret Ross O'Hare & Terence O'Hare, 38 The Strand, Williamstown	248.00	"	"
Mr Joseph Stephen O'Keane & Ms Amanda Joy Taylor, 16 Themeda Court, Meadow Heights	100.00	"	"
Lorraine O'Malley, 3/1 Melissa Place, Kings Park, NSW	157.05	"	28/04/00
Lorraine O'Malley, 3/1 Melissa Place, Kings Park, NSW	260.00	"	27/10/00
Paige O'Malley, 3/1 Melissa Place, Kings Park, NSW	120.70	"	28/04/00
Paige O'Malley, 3/1 Melissa Place, Kings Park, NSW	200.00	"	27/10/00
Grant O'Malley, 3/1 Melissa Place, Kings Park, NSW	157.05	"	28/04/00
Grant O'Malley, 3/1 Melissa Place, Kings Park, NSW	260.00	"	27/10/00
Richard O'Malley, 3/1 Melissa Place, Kings Park, NSW	120.70	"	28/04/00
Richard O'Malley, 3/1 Melissa Place, Kings Park, NSW	200.00	"	27/10/00
Tanya O'Meally, 4/6 Fenwick Street, Kew	208.00	"	28/04/00
Tanya O'Meally, 4/6 Fenwick Street, Kew	260.00	"	27/10/00
Mark Phillip O'Neill & Rick Phillip O'Neill & Jake Merrick O'Neill, 68 Macauley Ave, Bankstown, NSW	120.00	"	"
Mr Stephen O'Neill, 102/25 South Steyne, Manly, NSW	182.40	"	28/04/00
Vennard Francis O'Neill, "Estate V. F. O'Neill A/c", 61A Westbrook Avenue, Wahroonga, NSW	264.00	"	"
Vennard Francis O'Neill, "Estate V. F. O'Neill A/c", 61A Westbrook Avenue, Wahroonga, NSW	330.00	"	27/10/00
Michael Gerard O'Neill & Li-Chuen Wong, 30 Victoria Street, Erskineville, NSW	100.00	"	"
Sean O'Reilly, 1/22A Queenscliff Road, Queenscliff, NSW	108.00	"	"
Gemma Elisabeth O'Rourke, GPO Box 5138, Sydney, NSW	100.00	"	"
Stephen Arthur O'Rourke, "Lauren Alise Melia A/c", 20 Goorawahl Avenue, La Perouse, NSW	120.70	"	28/04/00
Stephen Arthur O'Rourke, "Lauren Alise Melia A/c", 20 Goorawahl Avenue, La Perouse, NSW	200.00	"	27/10/00
Stephen Arthur O'Rourke, "Nicole Anne Melia A/c", 20 Goorawahl Avenue, La Perouse, NSW	120.70	"	28/04/00
Stephen Arthur O'Rourke, "Nicole Anne Melia A/c", 20 Goorawahl Avenue, La Perouse, NSW	200.00	"	27/10/00

Stephen Arthur O'Rourke, "Rebecca Louise Melia A/c", 20 Goorawahl Avenue, La Perouse, NSW	120.70	"	28/04/00
Stephen Arthur O'Rourke, "Rebecca Louise Melia A/c", 20 Goorawahl Avenue, La Perouse, NSW	200.00	"	27/10/00
Gerard O'Shea, 23 Marshall Avenue, Kew	100.00	"	"
Andrew O'Sullivan, 25 Crabbes Street, Willoughby, NSW	100.00	"	"
Catherine Elizabeth O'Toole & Dennis James O'Toole, 19 O'Reilly Street, Mundingburra, Qld	100.00	"	"
Christopher R. Oakes, 65 Reserve Creek Road, Murwillumbah, NSW	157.05	"	28/04/00
Christopher R. Oakes, 65 Reserve Creek Road, Murwillumbah, NSW	260.00	"	27/10/00
Oakwood Super Co Pty Ltd, 20 Flood Street, Clovelly, NSW	100.00	"	"
Gilnar Obeid & Suzanna Obeid, 11 High St, Concord, NSW	120.00	"	"
David Michael Obrien, 267 Maroubra Rd, Maroubra, NSW	132.85	"	28/04/00
David Michael Obrien, 267 Maroubra Rd, Maroubra, NSW	220.00	"	27/10/00
Tamara Obrien, 90 John Oxley Drive, Frenchs Forest, NSW	100.00	"	"
Stephen Derriman Obrien, 1 Meigs Crescent, Stuart Park, NT	100.00	"	"
Christopher Paul Obrien & Helen Maree Obrien, 47 Palm Avenue, Ascot, Qld	100.00	"	"
Catherine Oconnor, 32 Killoola Street, Concord, Perth, WA	100.00	"	"
Kerryn Elizabeth Odell & David John Odell, 21/17 Wetherill Street, Narrabeen, NSW	100.00	"	27/10/00
Estate Harold Gerald Odonnell, C/- Mrs Pat Mervin, 3 Tyson Place, North Rocks, NSW	100.00	"	"
Mr Richard Oh, "R Oh Super Fund A/c", PO Box Y3046, East St Georges Terrace, NSW	160.00	"	28/04/00
Mrs Suzanne Jayne Oh, "Rebecca & Rachel Oh A/c", C/- PO Box Y3046, East St Georges Terrace, Perth, WA	100.00	"	27/10/00
Mrs Suzanne Jayne Oh, C/- PO Box Y3046, East St Georges Terrace, Perth, WA	100.00	"	"
Mrs Suzanne Jayne Oh, "Rebecca & Rachel Oh A/c", C/- PO Box Y3046, East St Georges Terrace, Perth, WA	200.00	"	"
Okalyi Enterprises Pty Ltd, "Okalyi Provident Fund A/c", 172 York Street, South Melbourne	151.00	"	28/04/00
Mr Kevin Cepric Okeby & Mrs Rosemary Hellena Okeby, "Okeby Family S/Fund A/c", 109 Woodcourt Road, Berowra Heights, NSW	133.60	"	27/10/00
David Okeefe, PO Box 437, Cremorne Junction, NSW	302.00	"	"
Shane Christopher Okeefe, 1/11 Ronald Ave, Harbord, NSW	144.00	"	28/04/00
Robert Okroglic, 47 Harold Street, Blacktown, NSW	120.00	"	"
Wakayo Okuda, 213/1 Boomerang Street, Sydney, NSW	120.70	"	"
Wakayo Okuda, 213/1 Boomerang Street, Sydney, NSW	200.00	"	27/10/00
Amy Leigh Oldfield & Tonya Leigh Oldfield, PO Box 473, Windsor, NSW	100.00	"	"
Oldham Pty Ltd, "Watkins Family S/F A/c", PO Box 274, Narrandera, Nsw NSW	140.00	"	"
Graeme Oliver, PO Box 467, Ballina, NSW	112.88	"	28/04/00
Graeme Oliver, PO Box 467, Ballina, NSW	186.60	"	27/10/00
Oliver Heights Pty Ltd, PO Box 6408, Shepparton	200.00	"	"
Margaret Amy Olsen & Robert Hugh Olsen, 3 Crompton Place, West Pennant Hills, NSW	160.00	"	28/04/00

Margaret Amy Olsen & Robert Hugh Olsen, 3 Crompton Place, West Pennant Hills, NSW	200.00	''	27/10/00
Damien Ronald Olver, PO Box 726, Ballarat	200.00	''	''
Paul Eugene Omahoney & Maureen Francis Omahoney & Subuki Pty Ltd, 273 Mona Vale Road, St Ives, NSW	144.95	''	28/04/00
Paul Eugene Omahoney & Maureen Francis Omahoney & Subuki Pty Ltd, 273 Mona Vale Road, St Ives, NSW	200.00	''	27/10/00
Mr Grant Craydon Omalley, 3/1 Melissa Place, Kings Park, NSW	181.30	''	28/04/00
Mr Grant Craydon Omalley, 3/1 Melissa Place, Kings Park, NSW	300.00	''	27/10/00
Mohd Taufiq Omar, 152 Sixth Avenue, Royston Park, SA	200.00	''	28/04/00
Mohd Taufiq Omar, 152 Sixth Avenue, Royston Park, SA	250.00	''	27/10/00
One World Music Pty Ltd, PO Box 244, Red Hill, Qld	200.00	''	''
Mr James Oneill & Mrs Charlotte Oneill, 3 Benelong Close, Kincumber, NSW	100.00	''	''
Gerald Seng Yew Ong, 65 Fishburn Crescent, Castle Hill, NSW	100.00	''	''
Kim S. Ong, 19 Spalding Street, Flynn, ACT	320.00	''	''
Boon Kheng Ong, 3/29 Hazel Street, Camberwell	140.00	''	''
Eng Joo Ong & Eng Yeau Ong, 16/8-10 Morton Street, Wollstonecraft, Nsw	240.00	''	''
Emily Ong, 206G/5 Rock Street, St Lucia, Qld	100.00	''	''
Eng Ming Ong & Eng Lian Ong, 16/8-10 Morton Street, Wollstonecraft, NSW	240.00	''	''
Open Technology Services Pty Limited, PO Box 160, Palm Beach, Qld	288.00	''	''
Anne Elizabeth Oppy, 2 Courbrant Court, Box Hill North	100.00	''	''
Mr Albert Gebara Optometrist, A2/226 The Boulevarde, Punchbowl, NSW	200.00	''	28/04/00
Alan D. Organ, 43 Nunns Road, Mornington	110.00	''	27/10/00
Aimee Ormaechea & Liam Ormaechea, 12 Yallambee Road, Lane Cove, NSW	362.15	''	28/04/00
Aimee Ormaechea & Liam Ormaechea, 12 Yallambee Road, Lane Cove, NSW	600.00	''	27/10/00
Sarah Jane Ormiston, 7 Clendon Court, Toorak	140.00	''	''
Suzanne Orourke, 20 Excelsior Rd, Mt Colah, NSW	136.00	''	28/04/00
Simon Orr, PO Box 39392, Winnellie, NT	100.00	''	27/10/00
Peter Orton, 8/48 Nicholson Pde, Cronulla, NSW	100.00	''	''
Aaron Orya, 42 Wehlow Street, Mount Druitt, NSW	100.00	''	''
Mr Paul Lynton Oscar, 44 Fonteyn Drive, Wantirna South	100.00	''	''
Michelle Oscar, 44 Fonteyn Dive, Wantirna	100.00	''	''
Oscar James Pty Ltd, 2/11 Ventnor Avenue, West Perth, WA	300.00	''	''
Eleanor Anne Osman, 31A Alexandra Ave, Rose Park, SA	192.00	''	28/04/00
Eleanor Anne Osman, 31A Alexandra Ave, Rose Park, SA	240.00	''	27/10/00
M. S. Tania Anne Ots, 60 Glenburnie Road, Vermont	100.00	''	''
Paul Oung, 12/46 Dartbrook Road, Auburn, NSW	108.60	''	28/04/00
Paul Oung, 12/46 Dartbrook Road, Auburn, NSW	180.00	''	27/10/00
Paul Soridh Oung, 109 Rawson Street, Auburn, NSW	160.00	''	''
Andrew Oung, 109 Rawson Street, Auburn, NSW	114.65	''	28/04/00
Andrew Oung, 109 Rawson Street, Auburn, NSW	190.00	''	27/10/00
Andrew Virak Oung, 109 Rawson Street, Auburn, NSW	120.70	''	28/04/00
Andrew Virak Oung, 109 Rawson Street, Auburn, NSW	200.00	''	27/10/00

Outram Pty Ltd, "Medici Super Fund A/c", PO Box 621, Broadway, NSW	100.00	"	"
Overseas Trading & Finance Co Ltd, C/- PO Box 518, Hawthorn	132.85	"	28/04/00
Peter William Owen & Glenise Joy Owen, RMB 4148, Marnoo Road, Stawell	192.00	"	"
Peter William Owen & Glenise Joy Owen, RMB 4148, Marnoo Road, Stawell	240.00	"	27/10/00
Robert John Owen, 6 Creal Place, Chisholm, ACT	120.70	"	28/04/00
Samantha Owen, RMB 4148, Stawell	100.00	"	27/10/00
Bruce Conner Owens, 52 Fitzroy Street, Burwood, NSW	150.00	"	"
Maureen Jane Owens, 6 Howard Close, Thornton, NSW	110.00	"	"
Ozdata Pty Ltd, Unit 4, 4 Esther Road, Balmoral, NSW	157.05	"	28/04/00
Taner Ozdemir & Genciz Ozdemir, 19 Parsons Street, Kensington	100.00	"	27/10/00
Ozpak Market Search (NSW) Pty Limited, "Milpar Super Fund Account", 54 Holt Ave, Mosman, NSW	110.00	"	"
P. A. OTS Pty Ltd, PO Box 68, Kew East	100.00	"	"
Pacajosa Investments Pty Ltd, 27 Fullarton Road, Eastwood, SA	100.00	"	"
Tohn Padas, 2 Burnett Street, Hurlstone Park, NSW	144.95	"	28/04/00
Tohn Padas, 2 Burnett Street, Hurlstone Park, NSW	240.00	"	27/10/00
Janet Suzanne Padgham, 27 Alice Street, Malvern	100.00	"	"
Lynda Page, 2 Renown Road, Balnarring	100.00	"	"
Barry Page, 2 Renown Road, Balnarring	100.00	"	"
Roger E. Page, 20 Marshall Avenue, Warrawee, NSW	120.70	"	28/04/00
Roger E. Page, 20 Marshall Avenue, Warrawee, NSW	200.00	"	27/10/00
Sarah Page, 36 Lakeview Gardens, Jerrabomberra, NSW	100.00	"	"
Carol Paggi, 17 Keane Way, Lesmurdie, WA	144.95	"	28/04/00
Carol Paggi, 17 Keane Way, Lesmurdie, WA	240.00	"	27/10/00
Sanil Pala, 28 Woodlands Road, Taren Point, NSW	100.00	"	"
Dr Con Paleologos, 14 Prince Edward St, Gladesville, NSW	624.00	"	28/04/00
Mr John Russell Palfreyman, 54 Elizabeth Street, Malvern	271.75	"	"
Mark David Palmer, PO Box 160, Palm Beach, Qld	272.00	"	27/10/00
George John Palmer, 20 Fleming Avenue, Cannington, WA	100.00	"	"
David Robert Palmer & Elisabeth Louise Palmer, "Rosewood Super Fund A/c", PO Box 102, Denmark, WA	120.00	"	"
Mr Anthony John Palmer & Mrs Lisa Palmer, 1606 Park Street, Houston Texas 77019 USA, USA	369.50	"	28/04/00
Mr Michael A. Palmer, PO Box 211, Deakin West, Canberra, ACT	222.00	"	27/10/00
Palos Holdings Pty Ltd, "Kostos Executive Fund A/c", 1/393 Little Street, Melbourne	200.00	"	"
Pama Scott Pty Ltd, "Scott Investment A/c", 30 Gellibrand Street, Campbell, ACT	100.00	"	"
Ian Huei Yann Pan, 11 Grandview Avenue, Dandenong	120.70	"	28/04/00
Ian Huei Yann Pan, 11 Grandview Avenue, Dandenong	200.00	"	27/10/00
Mr Scott Pan, 13 Andromeda Way, Lower Templestowe	100.00	"	"
Annette Panagis, 4 Rumbala Court, Bushland Beach, Qld	110.00	"	"
Terence John Panczyk, "Terence Panczyk Invest A/c", Level 1 58 Moorabool Street, Geelong	360.00	"	"
Pandora Holdings Pty Ltd, Claremont Arcade, Shop 16 Bayview Terr, Claremont, WA	100.00	"	"

Maria Pane, PO Box 43, Mooroolbark	190.00	''	''
Maria Pane-O'Neill. "Michael Anthony O'Neill A/c", PO Box 43, Mooroolbark,	130.00	''	''
Nicholas Pang, 3 Rippon Court, Templestowe	128.00	''	28/04/00
Ms Joyce Angeline Hok Yan Pang, 7 Amelup Place, Dianella, WA	100.00	''	27/10/00
Mrs Thu Nhi Pang, 6 Alison Avenue, Marion, SA	100.00	''	''
Joseph Peter Pantano & Emanuela Pantano, 18 Aquila Crescent, Endeavour Hills	200.00	''	''
Petros Pantelides, 15 Glencairn Way, Parkwood, WA	100.00	''	''
Papantoniou Superannuation & Fund Pty Ltd, "S/F A/c P. J. Papantoniou", 80 Bexley Rd, Campsie, NSW	150.00	''	''
Papantoniou Superannuation & Fund Pty Ltd, "KJY Papantoniou S/F A/c", 80 Bexley Rd, Campsie, NSW	150.00	''	''
Athena Papas, 2 Burnett St, Hurlstone Park, NSW	140.00	''	''
Estate Leonard Arthur Pappriell, C/- Patterson Byfield & Bryen, PO Box 27, Walcha, NSW	300.00	''	''
Est Leonard Arthur Pappriell, C/- Patterson Byfield & Bryen, PO Box 27, Walcha, NSW	420.00	''	''
Russell Allan Papst, 43 Anstey Avenue, Reservoir	100.00	''	''
Christopher John Pardey, 34 Churchill Rd, Killara, NSW	157.05	''	28/04/00
Christopher John Pardey, 34 Churchill Rd, Killara, NSW	260.00	''	27/10/00
John G. Pardey, 34 Churchill Road, Killara, NSW	217.20	''	28/04/00
John G. Pardey, 34 Churchill Road, Killara, NSW	360.00	''	27/10/00
Stephen Charles Paridis & Katherine Marie Paridis, "Sunset Coast Super Fund A/c", 42 Manning Street, Scarborough, WA	100.00	''	''
Nicole Mary Parish, 3/291 Arden Street, Coogee, NSW	112.00	''	28/04/00
Nicole Mary Parish, 3/291 Arden Street, Coogee, NSW	140.00	''	27/10/00
Mr Gregory John Parish, 166 Bapaume Road, Holland Park West, Qld	260.70	''	28/04/00
Mr Gregory John Parish, 166 Bapaume Road, Holland Park West, Qld	432.00	''	27/10/00
Joseph Parisi & Caroline Parisi, 22 Hedgepow Drive, Salisbury East, SA	100.00	''	''
Bruce Parke, "BJ & N Parke Super Fund Ac", 19 Ofarrell Street, Yarraville	160.00	''	28/04/00
David Ross Parker & Kellianne Margaret Parker, 5 Amaroo Avenue, Elanora Heights, NSW	100.00	''	27/10/00
Mrs Patricia Anne Parker, 54 Holt Avenue, Mosman, NSW	100.00	''	''
Ms Fiona Parker, 14 Clitus Street, Glen Waverley	120.00	''	''
Parker Court Pty Ltd, 21 Advantage Road, Highett	300.00	''	''
Larry Parkes, 41 Waratah Road, Engadine, NSW	100.00	''	''
Jannette Parkes, 41 Waratah Road, Engadine, NSW	134.40	''	28/04/00
Jannette Parkes, 41 Waratah Road, Engadine, NSW	168.00	''	27/10/00
Elizabeth Henty Parkin, 292 Edgevale Road, Kew	110.00	''	''
Parkinson Enterprises Pty Ltd, "Super Fund A/c", 11/7 Anella Avenue, Castle Hill, NSW	120.00	''	''
Raj Parmar, PO Box 492, Neutral Bay, NSW	100.00	''	''
Ms Vicki Parnell, Unit 3, 5 McDonald St, Cronulla, NSW	185.60	''	28/04/00
Mr Warren Parrant, 6 Willandra Place, Hillarys, WA	280.00	''	27/10/00
Mark Robert Parrant, 10 Beris Crescent, Eight Mile Plains, Qld	100.00	''	''
Jonathon Parry, 23 Cross Street, Swanbourne, WA	168.00	''	28/04/00

Jonathon Parry, 23 Cross Street, Swanbourne, WS	210.00	''	27/10/00
Svetlana Parsons, 16 Docker Street, Elwood	200.00	''	''
Susan Parsons, 51 Myoora Road, Terrey Hills, NSW	104.00	''	28/04/00
B. S. Parsons, "Parsons Staff S/Fund A/c", 5 Redmond Avenue, Baulkham Hills, NSW	100.00	''	27/10/00
Mr Bryce Charles Parsons & Mrs Patricia Elizabeth Parsons, 1/93 Pentecost Avenue, Pymble, NSW	320.00	''	28/04/00
Mr Bryce Charles Parsons & Mrs Patricia Elizabeth Parsons, 1/93 Pentecost Avenue, Pymble, NSW	800.00	''	27/10/00
Partage Pty Ltd, 21 Roslyn Gardens, Elizabeth Bay, NSW	166.40	''	28/04/00
Parvenu Nominees Pty Ltd, Unit 1, 23 Rheola Street, West Perth, WA	114.65	''	''
Peter Pascoe, 85 School Road, Capalaba, Qld	255.00	''	27/10/00
Adam Pask, PO Box 346, Niddrie	220.00	''	''
Maria Pasquariello, 30 Wetherill Street, Croydon, NSW	150.00	''	''
Barry Charles Pass, 23 Caladenia Street, Greenwood, WA	100.00	''	''
Pastoral Meat Pty Limited, "Considine Super Fund A/c", PO Box 321, Deakin West, ACT	100.00	''	''
Mr Tony Vincent Pastore, PO Box 462, Eltham	120.00	''	''
Catherine Veronica Patchell, 1051 Malvern Road, Toorak	100.00	''	''
Robert Edwin Patching, 115 Brandon Road, Runcorn, Qld	120.00	''	''
Pravin Maganbhai Patel & Purna Pravin Patel & Ravish Pravin Patel, 68/18-20 Knocklayde St, Ashfield, NSW	132.85	''	28/04/00
Pravin Maganbhai Patel & Purna Pravin Patel & Ravish Pravin Patel, 68/18-20 Knocklayde St, Ashfield, NSW	220.00	''	27/10/00
Kalpana C. Patel, 268 Belgrave Esplanade, Sylvania Waters, NSW	101.40	''	28/04/00
Chandresh C. Patel & Demple C Patel & Sonali C. Patel, 32 GyMEA Bay Road, GyMEA, NSW	100.00	''	27/10/00
Neetal P. Patel, 68/18-20 Knocklayde Street, Ashfield, NSW	100.00	''	''
Pravin M. Patel, 68/18-20 Knocklayde Street, Ashfield, NSW	100.00	''	''
Purna P. Patel, 68/18-20 Knocklayde Street, Ashfield, NSW	100.00	''	''
Jenika P. Patel, 68/18-20 Knocklayde Street, Ashfield, NSW	100.00	''	''
Ravish P. Patel, 68/18-20 Knocklayde Street, Ashfield, NSW	100.00	''	''
Suresh Bhai Patel, 3/323 Queen Street, Concord West, NSW	198.40	''	28/04/00
Nick Pateras, 42 Grantchester Road, Wheelers Hill	120.70	''	''
Ian Bruce Paterson & Karen Ennys Paterson, 51 Langridge Street, Collingwood	176.00	''	''
Ian Bruce Paterson & Karen Ennys Paterson, 51 Langridge Street, Collingwood	220.00	''	27/10/00
Estate Dorothy Lovie Paterson, C/- Gordon A. Salier, Level 6 - 90 Pitt Street, Paxton House, Sydney, NSW	100.00	''	''
Dennis J. Paterson, 21 Rotherwood Road, Ivanhoe	200.00	''	''
Mahendra Pathik, 18 Reynolds Court, Dynnynrne, Tas.	160.00	''	''
Pathold No 191 Pty Limited, 108 Renton Avenue, Moorebank, NSW	100.00	''	''
Patricia Investments Pty Ltd, C/- KPMG, GPO Box 223, Brisbane, Qld	500.00	''	''
Gwendoline J. Patricks, PO Box 410, Grafton, NSW	146.00	''	''
Mr Andrew John Patterson, 18/42 Jerrabomberra Avenue, Narrabundah, ACT	128.00	''	28/04/00
Est Eric Dickson Patterson, 24/1 Spencer Street, Wamberal, NSW	160.00	''	''

Est Eric Dickson Patterson, 24/1 Spencer Street, Wamberal, NSW	200.00	''	27/10/00
Lynn Pattinson, 8 Septinus Avenue, Punchbowl, NSW	160.00	''	28/04/00
Mr Brian John Pattinson & Mrs Jane Mary Pattinson, "Pots Superfund Account", 8 Boorowa Street, Young, NSW	100.00	''	27/10/00
Robert James Pattison & Lorraine Joan Pattison, 31 Lincoln Drive, Shepparton	120.00	''	''
Minerva Patu, 2b Parkview Avenue, Picnic Point, NSW	100.00	''	''
Sanju Patwardhan & Aditi Patwardhan & Ashwini Patwardhan, 11A Cheltenham Rd, Cheltenham, NSW	160.00	''	''
Geoffrey R Paul, 81 Seach Road, Bondi, NSW	120.70	''	28/04/00
Geoffrey R Paul, 81 Seach Road, Bondi, NSW	200.00	''	27/10/00
Ashish Paul, 42 Ashford Avenue, Castle Hill, NSW	132.85	''	28/04/00
Ashish Paul, 42 Ashford Avenue, Castle Hill, NSW	220.00	''	27/10/00
Mark Jason Pavisich & Nancy Bonfiglio-Pavisich, 24 Dunholme Street, Osborne Park, WA	120.00	''	''
Mark Jason Pavisich, PO Box 182, Osborne Park, WA	120.00	''	''
Noel Francis Payne, 8 Wills Street, Maryborough	100.00	''	''
Mr William Michael Payne, 8 Gallimore Avenue, Balmain, NSW	200.00	''	28/04/00
Mr William Michael Payne, 8 Gallimore Avenue, Balmain, NSW	250.00	''	27/10/00
Mr Phillip Payne, C/- PO Box 850, Port Moresby, Boroko NCD, Papua New Guinea	400.00	''	''
Mr David Arden Peabody, Level 10, 9 Sherwood Road, Toowong, Qld	540.00	''	''
Caroline Peacock, 56 Sunnyside Road, Glen Osmond, SA	130.90	''	28/04/00
Caroline Peacock, 56 Sunnyside Road, Glen Osmond, SA	217.00	''	27/10/00
Mr Adam Andrew Peacock, 32 Parker Point Rd, Rottneest Island, WA	100.00	''	''
Peacock Nominees Pty Ltd, PO Box 560, Geelong North	100.00	''	''
Peak Investments Pty Ltd, 52 Banool Road, Balwyn	241.45	''	28/04/00
Mr John Pearman, "Nathan A/c", 73 Lakeside Crescent, Forest Lake, Qld	128.00	''	27/10/00
Barry John Pearson, PO Box A124, Shellharbour, NSW	100.00	''	''
Estate Bruce Campbell Pearson, C/- Henty Jepson & Kelly, PO Box 1655N, Melbourne	336.00	''	28/04/00
Mark Pearson, 6/106 Herring Road, Marsfield, NSW	204.00	''	27/10/00
Pecora Agribusiness Pty Ltd, PO Box 201, South Fremantle, WA	100.00	''	''
Natalie Pedrini & Mark Pedrini, 37 Riverview Terrace, Mount Pleasant, WA	100.00	''	''
Andrew Johnathon Peek, 1209 East Tamar Highway, Dilston, Tas.	120.70	''	28/04/00
Andrew Johnathon Peek, 1209 East Tamar Highway, Dilston, Tas.	200.00	''	27/10/00
Leslie A. Peirce, 36 Polaris Drive, Doncaster East	424.00	''	28/04/00
Leslie A. Peirce, 36 Polaris Drive, Doncaster East	530.00	''	27/10/00
Mr Edmund Pelgen & Miss Jacqueline Margaret Vincent, 41 Caroline Street, Clifton Hill	100.00	''	''
Andrew Philip Pembroke, PO Box 66, Castlecrag, NSW	284.00	''	28/04/00
Andrew Philip Pembroke, PO Box 66, Castlecrag, NSW	355.00	''	27/10/00
John Wilfred Pennefather,			

3 Gladys Avenue, Frenchs Forest, NSW	100.00		”
Brian Pensa, 574 Anzac Highway, Glenelg East, SA	325.00		”
Pensan Pty Ltd, “Pengo Family S Fund A/c”, PO Box 1129, Mt Isa, Qld	368.00	”	”
Pensive Nominees Pty Ltd, GPO Box 1392M, Melbourne	200.00	”	”
Vanea Pentney, “JHA A/c”, 122 Artarmon Road, Artarmon, NSW	120.00	”	”
John Penton & Jack Penton, 3 Figtree Lane, Woollahra, NSW	100.00	”	”
Performance People, 47 Falcon Street, Crows Nest, NSW	254.40	”	28/04/00
Peranakan Pty Ltd, “William Wee Superfund A/c”, 13 Bradford Avenue, Kew	320.00	”	”
Peranakan Pty Ltd, “William Wee Superfund A/c”, 13 Bradford Avenue, Kew	400.00	”	27/10/00
Mr Les Laze Percevski, 2 Maybury St, Kahibah, NSW	181.30	”	28/04/00
Maureen J Percival, PO Box 220, Sunnybank, Qld	200.00	”	”
Mr Damien Perdon, 8 Avion Place, West Meadows	104.00	”	”
Dhammika Perera, 28 Oakover Street, East Fremantle, WA	100.00	”	27/10/00
Eutiquiano Perez, 4 Banniter Place, Mount Pritchard, NSW	280.00	”	”
Emma Katherine Perez, 151 Epsom Road, Chipping Norton, NSW	110.00	”	”
Graeme John Perich, 37 Norton Drive, Dianella, WA	140.00	”	”
Mr Stephen Peries, 46 Park Road, Burwood, NSW	152.00	”	28/04/00
Mr Remus Peries, 46 Park Road, Burwood, NSW	190.00	”	27/10/00
Walter Francis Perkins, 12 Moore Street, Elwood	224.00	”	”
Rubert Michael Perkins & Julie Fay Perkins, “Lymcabe Super Fund A/c”, PO Box 979, Fyshwick, ACT	132.85	”	28/04/00
Rubert Michael Perkins & Julie Fay Perkins, “Lymcabe Super Fund A/c”, PO Box 979, Fyshwick, ACT	220.00	”	27/10/00
Perpetual Trustee Company (Canberra) Limited, GPO Box 392, Canberra, ACT	320.00	”	”
Perpetual Trustee Company (Canberra) Limited, “2207TR01 Andrea A/c”, 39 Hunter Street, Sydney, NSW	141.00	”	”
Perpetual Trustee Company Ltd, “Janet Bower A/c”, 39 Hunter Street, Sydney, NSW	290.00	”	”
Perpetual Trustee Victoria Limited, ”13481AG01 Lightfoot A/c“, 39 Hunter Street, Sydney, NSW	101.00	”	”
Perpetual Trustee Victoria Limited, “12161TR03 Brown A/c”, 30 Hunter Street, Sydney, NSW	112.00	”	”
Perpetual Trustee Victoria Limited, "12168tr04 Buchan A/C", 30 Hunter Street, Sydney, NSW	105.00	”	”
Perpetual Trustee Victoria Limited, "12204TR01 Cherry A/c", 30 Hunter Street, Sydney, NSW	127.00	”	”
Perpetual Trustee Victoria Limited, “12784TR02 Murphy A/c”, 39 Hunter Street, Sydney, NSW	105.00	”	”
Perpetual Trustees Victoria Limited, “Jabara A/c”, 39 Hunter, Sydney, NSW	276.00	”	”
Perpetual Trustees Victoria Limited, 39 Hunter Street, Sydney, NSW	604.00	”	”
Perpetual Trustees Victoria Ltd, “GN Head A/c”, 39 Hunter Street, Sydney, NSW	160.00	”	”
Rocky Perre, 2/37 Eurobin Avenue, Manly, NSW	160.00	”	28/04/00
Amanda Perrett, 13 Balmoral Avenue, Lower Templestowe	160.00	”	27/10/00

Mr Mark Perrin, Unit 6, 18 Brighton Road, Glenelg East, SA	150.00	''	''
Carolyn Perry, Po Box 5272, Wagga Wagga, NSW	176.00	''	28/04/00
Philomel Perry, 72 Freya Street, Kareela, NSW	169.60	''	''
Alex Pertout, 7 Serafini Court, Eltham	160.00	''	27/10/00
Sivanantham Perumynar & Yasothai Perumynar, 7 Moala Street, Concord West, NSW	345.00	''	''
Len Pervan & Mark Phillip Pervan, 12 Taworri Way, City Beach, WA	436.00	''	''
Petair Investments Pty Ltd, "Staff Super Fund A/c", 496 High Street, Golden Square	100.00	''	''
Peter Williams & Associates Pty Limited, "Peter Willims S/Fund A/c", 74 Wolseley Road, Mosman, NSW	102.55	''	28/04/00
Peter Zeilic Pty Ltd, PO Box 2227, Clovelly, NSW	100.00	''	27/10/00
Peter Peters, C/O Hmas Coonawarra, Winnellie, NT	200.00	''	''
Mr Anthony Thomas Peters, PO Box 18151, Melbourne	458.15	''	28/04/00
Ms Shirley Lorraine Peters, 2 Edward Street, Geelong North	160.00	''	''
Ms Shirley Lorraine Peters, 2 Edward Street, Geelong North	200.00	''	27/10/00
Ms Jane Bridget Peters, Po Box 335, Dickson, ACT	260.00	''	''
Mr Chris Petkovski, 31/86 Derrima Rd, Queanbeyan, NSW	102.00	''	''
Andras L Petnehazy, 42 Pauls Drive, Valley View, SA	151.00	''	28/04/00
Andras L Petnehazy, 42 Pauls Drive, Valley View, SA	250.00	''	27/10/00
Roberto Petranuer, 46 Hillcrest Avenue, Hurstville, NSW	108.00	''	''
Mrs Helen Petritsis, 101 Ida Street, Sans Souci, NSW	160.00	''	28/04/00
Mrs Helen Petritsis, 101 Ida Street, Sans Souci, NSW	200.00	''	27/10/00
Mr Jamie Petroff & Mrs Katrina Petroff, "Petroff Super Fund A/c", 62 Claremont Avenue, Malvern	120.70	''	28/04/00
Vicktor Petroff, Unit 1124, 1 Lennie Avenue, Main Beach, Qld	160.00	''	28/04/00
Vicktor Petroff, Unit 1124, 1 Lennie Ave, Main Beach, Qld	220.00	''	27/10/00
Mr Stanisa Petrovic, PO Box 98, Maroubra, NSW	603.10	''	28/04/00
Pina Petti, 78 John Street, East Brunswick	120.00	''	27/10/00
Simon Pettig, 125 Devon Road, Ceres	120.00	''	''
Harold Arthur Pettit, 100 Canterbury Road, Canterbury	112.00	''	28/04/00
Harold Arthur Pettit, 100 Canterbury Road, Canterbury	140.00	''	27/10/00
Michaela Jayne Pettit & Harold Arthur Pettit, 7 Rowen Street, Burwood	112.00	''	28/04/00
Michaela Jayne Pettit & Harold Arthur Pettit, 7 Rowen Street, Burwood	140.00	''	27/10/00
Christopher James Pettit & Harold Arthur Pettit, 7 Rowen Street, Burwood	112.00	''	28/04/00
Christopher James Pettit & Harold Arthur Pettit, 7 Rowen Street, Burwood	140.00	''	27/10/00
Robert Bruce Peucker, 44 Anderson Road, Hawthorn East	100.00	''	''
Philip Pezzi, 73A Brougham Street, Kew	160.00	''	28/04/00
Philip Pezzi, 73A Brougham Street, Kew	200.00	''	27/10/00
Gavin Pfeiffer, 82 Fairbank St, Sunnybank, Qld	120.00	''	''
Mr Hung Pham, 54 Victoria Street, Revesby, NSW	120.70	''	28/04/00
An Vang Phan, 5a Edison St, Belmore, NSW	150.00	''	27/10/00
Pui Soon Phang, 7 Endeavour Avenue, St Clair, NSW	128.00	''	28/04/00
Teck Phang, 22 Consett Street, Concord West, NSW	160.00	''	27/10/00
Christopher Phelan & Karen Ann Phelan, 57 Clough Street, Mt Gravatt, Qld	100.00	''	''

Est Nancy Phillipps, C/- Equity Trustees Limited, GPO Box 2307V, Melbourne	120.00	''	''
Howard Ross Phillips & Madeleine Eva Phillips, 17 Violet Crescent, Brighton East	100.00	''	''
Julie Margaret Phillips, 1 Gibb Street, North Dandenong	160.00	''	28/04/00
Julie Margaret Phillips, 1 Gibb Street, North Dandenong	200.00	''	27/10/00
Mrs Martine Barrie Phillis, C/- Prescott Consultants, 245 Fullarton Road, Eastwood, SA	422.25	''	28/04/00
Mrs Martine Barrie Phillis, C/- Prescott Consultants, 245 Fullarton Road, Eastwood, SA	700.00	''	27/10/00
Annette Mary Philpott, 38 Foote Street, Brighton	402.95	''	28/04/00
Robert Wan Heng Pho, 128 Coronation Road, Singapore 269521 Singapore	100.00	''	27/10/00
Stephen Jack Phoenix, PO Box 5077, Mordialloc	120.86	''	28/04/00
Stephen Jack Phoenix, PO Box 5077, Mordialloc	200.20	''	27/10/00
Stephen Phoenix, "Phoenix Super Fund Account", PO Box 5077, Mordialloc	120.86	''	28/04/00
Stephen Phoenix, "Phoenix Super Fund Account", PO Box 5077, Mordialloc	200.20	''	27/10/00
Phoenix & Associates Pty Ltd, GPO Box 146, Doveton	120.86	''	28/04/00
Phoenix & Associates Pty Ltd, GPO Box 146, Doveton	200.20	''	27/10/00
Physmed Services Pty Ltd, Cnr Archer & Murray, Rockhampton, Qld	160.00	''	''
Phytoculture Pty Ltd, 29 Yulinda Terrace, Lower Mitcham, SA	136.00	''	28/04/00
Phytoculture Pty Ltd, 29 Yulinda Terrace, Lower Mitcham, SA	170.00	''	27/10/00
Piatto Jan Nominees Pty Ltd, PO Box 202, Holbrook, NSW	530.85	''	28/04/00
Mr Albert Pichay, 24 Allison Cres, Menai, NSW	200.00	''	27/10/00
Teresa Pick, 82 Melaleuca Drive, Palm Beach, Qld	148.00	''	''
Anna Pick, 82 Melaluca Drive, Palm Beach, Qld	100.00	''	''
Edith Pick, 82 Melaluca Drive, Palm Beach, Qld	100.00	''	''
Chris Pick, 82 Melaluca Drive, Palm Beach, Qld	100.00	''	''
Ian P Pickering, 11 Wirilda Drive, Burnie, Tas.	100.00	''	''
Mr Ron Pickering, "Zac Charles Pickering A/c", PO Box 112, Huskisson, NSW	100.00	''	''
Mr Ron Pickering, "Austin Rey Pickering A/c", PO Box 112, Huskisson, NSW	100.00	''	''
Miss Lynette L. Pickworth, 7 Kwani Place, Narraweena, NSW	100.00	''	''
Roger Picnik, 3/251 Oderon Street, Coogee, NSW	120.00	''	28/04/00
Roger Picnik, 3/251 Oderon Street, Coogee, NSW	150.00	''	27/10/00
Ms Debroah Picone & Mr Michael Picone, Level 5, 33 York Street, Sydney, NSW	144.95	''	28/04/00
Ms Debroah Picone & Mr Michael Picone, Level 5, 33 York Street, Sydney, NSW	240.00	''	27/10/00
Debroah Picone, Level 5, 33 York Street, Sydney, NSW	169.20	''	28/04/00
Debroah Picone, Level 5, 33 York Street, Sydney, NSW	280.00	''	27/10/00
Michael Picone & Debbie Picone, Level 5, 33 York Street, Sydney, NSW	169.20	''	28/04/00
Michael Picone & Debbie Picone, Level 5, 33 York Street, Sydney, NSW	280.00	''	27/10/00
Mr Kerry Picot, C/- 77 Hillvue Rd, South Tamworth, NSW	120.00	''	''

Picton Cove Pty Ltd, Suite 4, 320 Victoria Parade, East Melbourne	2,700.00	''	''
Zygmunt Pietraszek, 150 Brookdale St, Floreat, WA	100.00	''	''
Mrs Doreen Pietraszek, 150 Brookdale Street, Floreat, WA	100.00	''	''
Donna Pike, 4 Bantry Court, Kallaroo, WA	170.00	''	''
Mrs Tina Piliouras & Mr Jim Piliouras, 33B Ann Street, Stepney, SA	100.00	''	''
Mogasundra Ganess Pillay, 3/109 Frederick Street, Ashfield, NSW	220.00	''	''
Alain Pillay, 41 Junction Street, Sherwood, Qld	120.00	''	''
Aliza Pinczewski, 27 Calbina Road, Northbridge, NSW	114.65	''	28/04/00
Ms Michelle Ann Pinczewski, 4 Paltara Court, Eltham	200.00	''	27/10/00
Geoffrey Pinkerton, 45 Arundel Road, Park Orchards	100.00	''	''
Frank Pinto, 64 Newmount Road, Glen Waverley	100.00	''	''
Tony Pisano, 156 Blyth Street, Brunswick East	160.00	''	''
Mr Rohan Pitchford, 4 Morphy Place, Cook, ACT	120.70	''	28/04/00
Mr Paul Pizzata, 107 Kingston Street, Haberfield,	150.00	''	27/10/00
Michalo Pjekne, 5 Davies Court, Sunbury	100.00	''	''
Planet Computer Services Pty Ltd, "Super Fund A/c", 56 Fewster Road, Hampton	408.00	''	''
Planet Managed Investments P/L, 56 Fewster Rd, Hampton	140.00	''	''
Plantation On Wheels Pty Ltd, "Super Fund A/c", C/- Palmers, 629-631 Pittwater Road, Dee Why, NSW	267.00	''	''
Julian Charles Plante, 4/6 Ocean Ave, Newport, NSW	128.00	''	28/04/00
Mr Alan William Playford, 63 St Albans Way, Laurieton, NSW	100.00	''	27/10/00
Gunther Pleml, 5 Pompadour Street, Sunnybank Hills, Qld	110.00	''	''
Harold Plumley, 6 Prangley Street, Mangere, Auckland, NZ	295.60	''	28/04/00
Mrs Rhonda Margaret Plunkett, 52 Menzies St, Wodonga	100.00	''	27/10/00
PO De TV Productions Pty Ltd, PO Box 663, Sydney Markets, NSW	200.00	''	''
John Richard Pockley & Alison Clare Pockley, PO Box 154, Innaloo City, WA	160.00	''	''
Jamie Pollard, 88 Ashburton Street, Victoria Park East, WA	160.00	''	''
Poloka Pty Ltd, "Tottle Super Fund A/c", C/- ABN Amro Morgans MPS, GPO Box 582, Brisbane, Qld	241.45	''	28/04/00
Leonard Mcallister Polson, PO Box 18, Morphett Vale, SA	108.60	''	''
Polytex Industries Pty Limited, 179 Mimosa Road, Greenacre, NSW	136.00	''	''
Polytex Industries Pty Limited, 179 Mimosa Road, Greenacre, NSW	170.00	''	27/10/00
Mr Lou Ponte & Mr Joseph Ponte, "L & J Ponte Super Fund A/c", 9 Sherwood Rd, Mt Waverley	120.70	''	28/04/00
Kim Poole, 20 Birdwood Avenue, Como, WA	100.00	''	27/10/00
Mr James Hayward Poole & Mrs Louise Gay Poole, GPO Box 128A, Melbourne	100.00	''	28/04/00
Brian Paul Pooley, 20 Teague Street, Cook, ACT	140.00	''	27/10/00
Brian Paul Pooley, 20 Teague Street, Cook, ACT	230.40	''	28/04/00
Brian Paul Pooley, 20 Teague Street, Cook, ACT	382.00	''	27/10/00
Wai Ling Poon, 39/1740 Pacific Highway, Wahroonga, NSW	224.00	''	28/04/00
Igor Popovic, 39 Wungan Street, McLeod	120.00	''	27/10/00
Mr Henry Giovanni Porcaro, 16 Vynland Drive, Flagstaff Hill, SA	240.00	''	''

Port Hacking Real Estate Superannuation Fund, 13A Smarts Crescent, Cronulla, NSW	100.00	''	''
Ashman Family Trust S/Fund A/c, 14 Smith Road, Artarmon, NSW	208.00	''	28/04/00
Portadown Nominees Pty Ltd, "Ashman Family S/F A/c", 14 Smith Road, Artarmon, NSW	181.30	''	''
Jeffrey Portelli, 20 Bildera Place, Grays Point, NSW	392.00	''	''
Jeffrey Portelli, 20 Bildera Place, Grays Point, NSW	490.00	''	27/10/00
Trevor James Porter, "Super Fund A/c", PO Box 757, Chatswood, NSW	252.00	''	28/04/00
Hector Portero, 85 Baptist Street, Redfern, NSW	150.00	''	27/10/00
Sandra Merrilyn Portlock, 13 Vanberg Road, Essendon	100.00	''	''
Maarten Thomas Post & Leigh Suzanne Post, 3 Greenmeyer Court, Greensborough	108.60	''	28/04/00
Maarten Thomas Post & Leigh Suzanne Post, 3 Greenmeyer Court, Greensborough	180.00	''	27/10/00
Poten Pty Limited, 108 Renton Avenue, Moorebank, NSW	100.00	''	''
Lisa Potter, 233 South Road, Morphett Vale, SA	400.00	''	''
Allan Potter, 233 South Road, Morphett Vale, SA	400.00	''	''
Malcolm Potter, 9 Oleander Avenue, Port Macquarie, NSW	100.00	''	''
Clifford John Powell, 49 Queens Rd, Newlampton, NSW	140.00	''	''
Kristen Ann Powell, 8 Balemo Place, Bangor, NSW	210.00	''	''
Stewart Brian Powell, 8 Balemo Place, Bangor, NSW	210.00	''	''
Bill Power, 6/11 Waruda Street, Kirribilli, NSW	160.00	''	28/04/00
Vishve Jyoti Prakash, 18 Tasman Ave, Strathmore Heights	100.00	''	27/10/00
Philip Prapulenis, 51 John Street, Eltham	100.00	''	''
Mrs Sushila Devi Prasad, 100 Targo Road, Girraween, NSW	288.00	''	28/04/00
Mrs Sushila Devi Prasad, 100 Targo Road, Girraween, NSW	360.00	''	27/10/00
Jens Preikschat, 52 Gross Avenue, Hemmant, Qld	120.00	''	''
John Albert Prendergast, 11 Prosser St, Orford, Tas.	112.00	''	28/04/00
Matthew Prentice, 49 Salted Point Parade, Salted Point, WA	100.00	''	27/10/00
David Prentice & Pauline Abordi Prentice, 6 MacFarlan Street, South Yarra	100.00	''	''
Deidre Preston, 57 Adcock Crescent, Nakara, NT	100.00	''	''
Christopher Robert Pretty, 10 Boger Street, Benalla	184.00	''	28/04/00
Mr Patrick Price, GPO Box 1293, Canberra, ACT	160.00	''	''
Matthew Price, 40 Shaw Street, Petersham, NSW	242.55	''	''
Matthew Price, 40 Shaw Street, Petersham, NSW	402.00	''	27/10/00
Mr Darron William Price, Unit 7/3 Thornton Street, Fairlight, NSW	400.00	''	''
Adrian P. Pricolo, 27 Grove St, Marrickville, NSW	144.95	''	28/04/00
David R. Pride, 14 Coombs Street, Rockingham, WA	181.30	''	''
David R. Pride, 14 Coombs Street, Rockingham, WA	300.00	''	27/10/00
Catherine Prideaux, 15 Dynnyrne Road, Dynnyrne, Tas.	112.00	''	28/04/00
Catherine Prideaux, 15 Dynnyrne Road, Dynnyrne, Tas.	140.00	''	27/10/00
Judith Helen Pridmore, 9 Harris Road, Five Dock, NSW	120.00	''	''
Ms Judy Pridmore, 9 Harris Road, Five Dock, NSW	128.00	''	28/04/00
Ms Judy Pridmore, 9 Harris Road, Five Dock, NSW	160.00	''	27/10/00
Anna Priestley, 22 Alt Street, Queens Park, NSW	240.00	''	28/04/00
Mrs Susan Rosemary Priestley, "Sarah Priestley A/c", 8 Cosham Street, Brighton	100.00	''	27/10/00
Louise Elizabeth Pringle, 26 Claremont St, Buderim, Qld	100.00	''	''

Graham John Prior & Patricia Anne Prior, 1/9 Pedit Place, Cherrybrook, NSW	257.00	''	''
John Priskas, 44 Bowen Street, Moonee Ponds	220.00	''	''
John Priskas & Paul Priskas, 44 Bowen St, Moonee Ponds	212.00	''	''
Doug Pritchard, 95 O'Heas Street, Coburg	120.70	''	28/04/00
Doug Pritchard, 95 O'Heas Street, Coburg	200.00	''	27/10/00
Proactive People Pty Ltd, 5/65 Walker Street, North Sydney, NSW	140.00	''	''
Robyne Kaye Profitt, Lot 7, South Callignee Road, Callignee	100.00	''	''
Brian Paul Proley, 20 Teague Street, Cook, ACT	140.00	''	''
Mae Amber Proudley, 12 Wentworth Avenue, Sandringham	140.00	''	''
Mrs Julie Provest, 130a Windebanks Rd, Happy Valley, SA	240.00	''	''
PTW Pty Limited, "Super Fund A/c", PO Box 353, Miranda, NSW	100.00	''	''
PTW Pty Ltd, PO Box 353, Miranda, NSW	108.60	''	28/04/00
PTW Pty Ltd, PO Box 353, Miranda, NSW	180.00	''	27/10/00
Poloka Pty Ltd, C/- ABN Amro Morgans MPS, GPO Box 582, Brisbane, Qld	100.00	''	''
Ptype By Pixie Pty Ltd, 1st Floor, 262 Queen Street, Melbourne	100.00	''	''
Michelle Pullicino, 2 Cassina Place, Baulkham Hills, NSW	107.40	''	''
Pumpers Pty Ltd, "Pumps Retirement Fund A/c", 14 Athlone Street, Floreat, WA	350.00	''	''
Sheila Purcell, 3 Brentley Close, Narre Warren North	112.00	''	28/04/00
Put Option Services Pty Ltd, PO Box 18151, Melbourne	362.15	''	''
Wen Liang Qin, 4 Bella Court, Doncaster East	140.00	''	27/10/00
Quadrant Constructions Pty Ltd, 4 Corrong Court, Eltham	127.90	''	28/04/00
Qualtex Pty Ltd, "Superannuation Fund A/c", PO Box 1047, North Fitzroy	120.70	''	''
Qualtex Pty Ltd, "Superannuation Fund A/c", PO Box 1047, North Fitzroy	200.00	''	27/10/00
Quantum Computers (Aust) Pty Ltd, Level 1, 566 Elizabeth Street, Melbourne	100.00	''	''
Virginia Louise Quarmbly, PO Box 51, Bargo, NSW	100.00	''	''
Paul Arthur Quarrell, Debora Lynn Quarrell, "Quarrell Super Fund A/c", 3 Garden Court, Golden Grove, SA	181.30	''	28/04/00
Paul Arthur Quarrell, Debora Lynn Quarrell, "Quarrell Super Fund A/c", 3 Garden Court, Golden Grove, SA	300.00	''	27/10/00
Mrs Diana Jane Scott Quattromini, C/- J C Scott Waine, PO Box 623, Wahroonga, NSW	100.00	''	''
Wendy Wei-Ching Quay, 48A Victoria Crescent, Mont Albert	100.00	''	''
Margaret Quearns, "Levi Hewett A/c", Unit 4, 1 Hamilton Street, Newmen, WA	100.00	''	''
Kevin Juan Keat Quek, 3 Overland Drive, Vermont South	100.00	''	''
Harold Francis Quinn & Jean Marion Quinn, 439A Willarong Road, Caringbah, NSW	285.60	''	28/04/00
Michael Anthony Quinn, 13 Wrixon Street, Kew	205.60	''	''
Roger Damien Quinn & Robyn Joy Quinn, "Wimbledon Homes S/F A/c", 6 Brulu Close, Mt Eliza	100.00	''	27/10/00
Ian Quinn, PO Box 404, Kogarah, NSW	127.90	''	28/04/00
Quinn Investments Pty Ltd, "Unit A/c", 6 Brulu Close, Mount Eliza	300.00	''	27/10/00

Ms Anne Delyse Quinnell & Mr Cameron John Paul, 159 Stubbs Terrace, Daglish, WA	160.00	''	28/04/00
Quinnkins Pty Ltd, RMB 2807, Sale	100.00	''	27/10/00
Patrick Philip Quinon, 4/30 Hunter Street, Malvern	120.00	''	''
Arthur Ross Quinton & Florrie Quinton, 65 Lake Pde, Corrimal East, NSW	112.00	''	28/04/00
Arthur Ross Quinton & Florrie Quinton, 65 Lake Parade, Corrimal East, NSW	140.00	''	27/10/00
Quinton Pty Ltd, PO Box S46, Adelaide, SA	160.00	''	28/04/00
Quinton Pty Ltd, PO Box S46, Adelaide, SA	200.00	''	27/10/00
Patricia Mary Quirk, Lighthouse Cottage, Barrenjoey Lighthouse, Palm Beach, NSW	192.00	''	28/04/00
Patricia Mary Quirk, Lighthouse Cottage, Barrenjoey Lighthouse, Palm Beach, NSW	240.00	''	27/10/00
R. & M. Corporations Pty Ltd, PO Box 6874, Gold Coast MC, Qld	100.00	''	''
R. N. & C. Demaio Pty Ltd, "Demaio Super Fund A/c", 12 Fakenham Road, Ashburton	500.00	''	''
Manfred Raabe, 95 Atchison Street, Crows Nest, NSW	120.70	''	28/04/00
Manfred Raabe, 95 Atchison Street, Crows Nest, NSW	200.00	''	27/10/00
Ian Rackett, Unit 51, 758-768 Bourke St, Redfern, NSW	100.00	''	''
Casandra Antigone Radunovich, 2 Highes Street, Kununoppin, WA	160.00	''	28/04/00
Ms Astrid Raetze & Mr Phillip Manwarring, 8/21 Waruda Street, Kirribilli, NSW	150.00	''	27/10/00
Rai Pty Ltd, Lot 4, Shreeve Road, Canning Vale, WA	360.00	''	''
Indiran Anton Rajadurai, "I. A. Rajadurai S/Fund A/c", 16A Northcote Road, Armadale	240.00	''	28/04/00
Indiran Anton Rajadurai, "I. A. Rajadurai S/Fund A/c", 16A Northcote Road, Armadale	300.00	''	27/10/00
Vijaylakshman Rajeswaran, PO Box 1129, Boroko Post Office NCD, Papua New Guinea	177.36	''	28/04/00
Vijaylakshman Rajeswaran, PO Box 1129, Boroko Post Office NCD, Papua New Guinea	240.00	''	27/10/00
Vijayashankar Rajeswaran, PO Box 1129, Boroko Post Office NCD, Papua New Guinea	177.36	''	28/04/00
Vijayashankar Rajeswaran, PO Box 1129, Boroko Post Office NCD, Papua New Guinea	240.00	''	27/10/00
Vijayaharan Rajeswaran, PO Box 1129, Boroko Post Office NCD, Papua New Guinea	177.36	''	28/04/00
Vijayaharan Rajeswaran, PO Box 1129, Boroko Post Office NCD, Papua New Guinea	240.00	''	27/10/00
Marianne Rajkovic, 31 Sharland Avenue, Chatswood, NSW	128.00	''	28/04/00
Judith Mary Ralston, 75 St Marys Street, Camperdown, NSW	100.00	''	27/10/00
Michael Ramljak, 29 Stanley Street, Surwood, NSW	100.00	''	''
Mr Anthony Randall, Unit 14, 30 Morton Street, Wollstonecraft, NSW	176.00	''	28/04/00
Rodney Randall, 14-16 Beckett Road, Donvale	100.00	''	27/10/00
Graham Raneberg, PO Box 444, Caulfield East	150.00	''	''
Sukhdip S. Rangi, PO Box 82, Neutral Bay, NSW	284.80	''	28/04/00
Jacqueline Amelia Rankin, Julie Vale, Julie Vale Station, Goodooga, NSW	100.00	''	27/10/00
Jock Rankin, "Olivia Rankin A/c", RSD 3532, Woodend	120.00	''	''

Ronald C. Rankine, 8 Northam Avenue, Bardon, Qld	160.00	''	28/04/00
Ronald C. Rankine, 8 Northam Avenue, Bardon, Qld	200.00	''	27/10/00
Mr Peter Frances Rashleigh & Mrs Helen Christine Rashleigh, "The Rashleigh Family A/c", 7 Seabreeze Ave, Ferny Creek	200.00	''	''
Mrs Devaki Janaki Rasiah, "Prashanth Rasiah A/c", 14 Greenbriar Avenue, Wheelers Hill	112.00	''	28/04/00
Mrs Devaki Janaki Rasiah, "Prashanth Rasiah A/c", 14 Greenbriar Avenue, Wheelers Hill	140.00	''	27/10/00
Mrs Devaki Janaki Rasiah, "Thabojan Rasiah A/c", 14 Greenbriar Avenue, Wheelers Hill	112.00	''	28/04/00
Mrs Devaki Janaki Rasiah, "Thabojan Rasiah A/c", 14 Greenbriar Avenue, Wheelers Hill	140.00	''	27/10/00
Mrs Devaki Janaki Rasiah, "Sulakshan Rasiah A/c", 14 Greenbriar Avenue, Wheelers Hill	112.00	''	28/04/00
Mrs Devaki Janaki Rasiah, "Sulakshan Rasiah A/c", 14 Greenbriar Avenue, Wheelers Hill	140.00	''	27/10/00
Geoff Rawlins, "Alicia & Shane Rawlins A/c", 2 Woodland Street, Strathmore	120.00	''	''
Raxall Pty Ltd, PO Box 146, Flinders	300.00	''	''
Mr Michael James Ray, 45 Drummond Road, Seville	100.00	''	''
Rayne Pty Ltd, Level 1, 1155 Malvern Road, Malvern	128.00	''	28/04/00
Rayne Pty Ltd, Level 1, 1155 Malvern Road, Malvern	160.00	''	27/10/00
Mr Andrew Raynor, 22/1517 Malvern Road, Glen Iris	140.00	''	''
Reaburn Investments Pty Ltd, "Reaburn Super Fund A/c", PO Box 26, Nobby Beach, Qld	100.00	''	''
Anthony William Read, 20 Summerhill Road, Beaumaris	100.00	''	''
Mr Wayne K. Read, 59 Harrison Street, Brunswick East	100.00	''	''
Mr James Thomas Ready, 'Eulamere', 87 Mowbray Terrace, East Brisbane, Qld	100.00	''	''
Really Big Tomatoes Pty Ltd, 91 Simpson Street, East Melbourne	320.00	''	28/04/00
Realpolitik Pty Ltd, 4 Judith Court, Vermont South	220.00	''	27/10/00
Mr Shane Leslie Rearden, 15 Tarana Crescent, Dharruk, NSW	250.00	''	''
Mr Gary Robert Reardon, "Reardon Estate Proceeds A/c", 44 Woodlands Drive, Blackmans Bay, Tas.	160.00	''	''
Angelo Rech & Helen Rech, 50 Blackwood Park Road, Ferntree Gully	102.55	''	28/04/00
Angelo Rech & Helen Rech, 50 Blackwood Park Road, Ferntree Gully	170.00	''	27/10/00
Redwood Asset Pty Ltd, PO Box 351, South Perth, WA	150.00	''	''
Mark Owen Thomas Reed, 17 Selwyn Street, Blackburn	100.00	''	''
Mr Benjamin John Reed, 15 Scotsdowne Road, Trumpington CB2 2HU United Kingdom	203.97	''	28/04/00
Mr Benjamin John Reed, 15 Scotsdowne Road, Trumpington CB2 2HU United Kingdom	276.00	''	27/10/00
Mr Peter Robert Reed & Mrs Manuela Maria Enrica G. Reed, PO Box W4, Brookvale, NSW	181.30	''	28/04/00
Estate Lorraine Rees, 8 Kirkwood Road, Cronulla, NSW	160.00	''	27/10/00
Brad Reeson, 30/129 Bower Street, Manly, NSW	100.00	''	''
Patricia Reeve, 4 Gynea Court, Glen Waverley	100.00	''	''
Andrew Paul Reeves, 17 Mason Street, Hawthorn	151.00	''	28/04/00
Warren George Reid, 177 Melville Road, Pascoe Vale South	307.20	''	''

Francis Anthony Reid & Geraldine Alle Reid, 3 Barralluff Avenue, Bondi Beach, NSW	100.00	''	27/10/00
Jonathan George Reidsmith, "Super Fund A/c", 466 Regency Road, Blair Athol, SA	196.80	''	28/04/00
Jonathan George Reidsmith, 466 Regency Rd, Blair Athol, SA	181.30	''	''
Reidy Corp Pty Ltd & Renny Nominees Pty Ltd, Trustee "Super Fund A/c", 220 Johnston St, Collingwood	288.00	''	''
Reidy Corp Pty Ltd & Renny Nominees Pty Ltd, Trustee "Super Fund A/c", 220 Johnston St, Collingwood	360.00	''	27/10/00
Bernard Patrick Reilly, 14 Moore Street, Rozelle, NSW	100.00	''	''
Mr Clifford Marie Philippe Reily & Mrs Marcella Catherine Reily, 5 Cecil Street, Yarraville	147.80	''	28/04/00
Mrs Lauma Reinfelds & Mr Juris Reinfelds, 26 Cochrane Street, West Wollongong, NSW	120.70	''	''
Mrs Lauma Reinfelds & Mr Juris Reinfelds, 26 Cochrane Street, West Wollongong, NSW	200.00	''	27/10/00
Mr Scott Anthony Reinke, Unit 3, 3 Elizabeth Bay Crescent, Elizabeth Bay, NSW	100.00	''	''
Theresa Jozephine Remedios, 61/61 Nicholson Street, Bentleigh	100.00	''	''
Mr Ling Fu Ren, 8/27 Albion Road, Box Hill	200.00	''	''
Kylie Anne Renkie, PO Box 3159, Putney, NSW	112.00	''	28/04/00
Ms Margaret Anne Rennie, 18 South St, Rydalmere, NSW	192.00	''	''
Margaret Anne Rennie & Cassandra Rennie, 18 South Street, Rydalmere, NSW	112.00	''	28/04/00
William Brian Rennie, PO Box 3159, Putney, NSW	112.00	''	''
Jason William Rennie, PO Box 3159, Putney, NSW	112.00	''	''
Repas Consulting Pty Ltd, 23/91-93 Acacia Road, Sutherland, NSW	176.00	''	''
Repas Consulting Pty Ltd, 23/91-93 Acacia Road, Sutherland, NSW	220.00	''	27/10/00
Replacament Carburettors Pty Ltd, PO Box 82 5/43 Leighton Place, Hornsby, NSW	328.00	''	''
Rest Fox Pty Ltd, "Staff Super Fund A/c", 32 Crestville Avenue, Forrestville, NSW	100.00	''	''
John Lindesay Rex, PO Box 12130, Brisbane, Qld	600.00	''	''
Reynella Hotel Pty Ltd, "The Vaughton Super A/c", C/- Cavendish, PO Box 6123, Halifax Street, Adelaide, SA	480.00	''	''
Anthony Walter Beeman Reynolds, Somerton, Lake Bathurst, NSW	100.00	''	''
Amelia Margaret Reynolds, 5 Graham Road, Knoxfield	100.00	''	''
Katrina Reynolds, 5 Graham Street, Knoxfield	100.00	''	''
Grant Reynolds, 5 Graham Road, Knoxfield	100.00	''	''
Reynolds Services Pty Ltd, 2/144 Blackburn Road, Doncaster East	247.00	''	''
Frederick Henry Rhodes & Frances Emily Rhodes, 24 Bondell Avenue, Gympie, NSW	120.00	''	''
Lenore Rhodes, "Jack & Michelle & Daniel Rhodes A/c", RMB 4000, Talgarno Road, Via Wodonga	120.00	''	''
Robert Rhichard Rhodes, "Photo Lettering Ser S/F A/c", Level 4, 162 Goulburn Street, Darlinghurst, NSW	126.75	''	28/04/00

Robert Rhichard Rhodes, "Photo Lettering Ser S/F A/c", Level 4, 162 Goulburn Street, Darlinghurst, NSW	210.00	"	27/10/00
Riana Financial Services, 71 Palm Avenue, Ascot, Qld	100.00	"	"
Riana Financial Services Pty Ltd, 71 Palm Avenue, Ascot, Qld	100.00	"	"
Domenico Ricci & Orsolina Ricci, 17 Dawn Avenue, Hectorville, SA	200.00	"	"
Ms Annabelle Elvie Rice, Unit 4, 61 Blessington Street, St Kilda	100.00	"	"
Mr Stephen Mark Rice, 44A Lambrook Terrace, London SW6 6TG United Kingdom	142.26	"	28/04/00
Mr Stephen Mark Rice, 44A Lambrook Terrace, London SW6 6TG United Kingdom	192.50	"	27/10/00
Robert Richard, "Rig Richard Staff S Fund", 14/26 Walton Crescent, Abbotsford, NSW	147.90	"	"
Robert Richard, "Rig Richard Staff S/F A/c", 14/26 Walton Crescent, Abbotsford, NSW	400.00	"	"
Robert Ian Geoffrey Richard, "Rig Richard Staff S Fund", 14/26 Walton Crescent, Abbotsford, NSW	200.00	"	"
Ronald James Richards & Stanley Richards, 78 Tara Street, Sylvania, NSW	100.00	"	"
David Richards, 95 Wheatley Road, McKinnon	176.00	"	28/04/00
Gary Richardson & Suzanne Richardson, 2 Keller Close, Greenvale	140.00	"	27/10/00
Tamara Bree Richardson, 7 Warner Court, Donvale	100.00	"	"
Nancy Jacoba Richardson, C/- Mr AJD Richardson, 1 Castlereach Street, Sydney, NSW	201.73	"	28/04/00
Nancy Jacoba Richardson, C/- Mr AJD Richardson, 1 Castlereach Street, Sydney, NSW	334.60	"	27/10/00
Mr Bruce Logan Richardson, 10 Robinson Street, Subiaco, WA	152.00	"	28/04/00
Miss Janet Elizabeth Rickard, 7 Thorngate Close, Penwortham, Preston, Lancs PR1 OXN	118.24	"	"
Carmen Lorraine Rickard, 3 Jobson Avenue, Mount Ousley, NSW	100.00	"	27/10/00
Ian Ricketts & Patricia Ricketts, 13 Monaro Court, South Vermont	100.00	"	"
Christine Anne Ricthie, 30 Vine Street, Prospect, SA	180.00	"	"
Amanda Louisa Riddell, 1 Durham Street, Richmond	192.00	"	28/04/00
Amanda Louisa Riddell, 1 Durham Street, Richmond	240.00	"	27/10/00
Amanda Louise Ridley, 47 Paddington Street, Paddington, NSW	140.00	"	"
Joel Simon Ridley, 2/64 Pinjarra Road, Mandurah, WA	100.00	"	"
Mark J. Rigaldi, 58 Acacia Street, Upwey	100.00	"	"
Annabelle Elvie Rile, 83 Bayview Street, Prahran	120.70	"	28/04/00
Annabelle Elvie Rile, 83 Bayview Street, Prahran	200.00	"	27/10/00
Ben Riley, 46 Grevillea Way, Blackwood, SA	160.00	"	"
Mrs Desma A Ringer, 2 Beryl Close, Greensborough	145.40	"	"
Mr David Andrew Rintoul, Unit 3, 156 Crown Street, Sydney East, NSW	100.00	"	"
Lisa Ritchie, 5/350 Lower Plenty Road, Rosanna	100.00	"	"
Mr Ronald David Ritchie, 111 Gardenia Parade, Greystanes, NSW	100.00	"	"

Est Henry Anton Ritz, C/- Perpetual Trustee Co Ltd, 5th Floor 39 Hunter Street, Sydney, NSW	728.00	''	''
Est Henry Ritz, C/- Perpetual Trustee Co Ltd, 5th Floor 39 Hunter Street, Sydney, NSW	100.00	''	''
Riverline Nominees Pty Ltd, Level 37, 225 George Street, Sydney, NSW	151.00	''	28/04/00
Riverline Nominees Pty Ltd, Level 37, 225 George Street, Sydney, NSW	250.00	''	27/10/00
Riverline Nominees Pty Ltd, "Mainsbridge Super Fund A/c", C/- Blake Dawson Waldron, Level 37, 225 George Street, Sydney, NSW	120.70	''	28/04/00
Riverline Nominees Pty Ltd, "Mainsbridge Super Fund A/c", C/- Blake Dawson Waldron, Level 37, 225 George Street, Sydney, NSW	200.00	''	27/10/00
Mr Phillip Rix, Rix Levy Fowler, 49 Hampden Road, Nedlands, WA	200.00	''	''
Ivan Rizio, "Rizio Family A/c", 16 Orange Grove, Camberwell	140.00	''	''
Stephen Roach, 2 Evelina Road, Toorak	200.00	''	''
Ms Catherine Robb, 'Crickstown', 561 Goulburn Valley Highway, RMB Alexandra	150.00	''	''
Robert Lye Hin Lee, C/- Bongiorno and Partners, L6/203 New South Head Road, Edge Cliff, NSW	120.70	''	28/04/00
Robert Poulaine Nominees Pty Ltd, C/- Robert Pauline, 32 Sorlie Road, Frenchs Forrest, NSW	100.00	''	27/10/00
Robert White Pty Ltd, "Superannuation Fund A/c", GPO Box 592, Brisbane, Qld	140.00	''	''
Craig Walter Roberts & Elizabeth Valinda Roberts, 41 Bucknell Street, Newtown, NSW	128.00	''	28/04/00
Craig Walter Roberts & Elizabeth Valinda Roberts, 41 Bucknell Street, Newtown, NSW	160.00	''	27/10/00
Mark Thomas Roberts & Julie Marie Thomson, PO Box N910, Sydney, NSW	120.70	''	28/04/00
Mark Thomas Roberts & Julie Marie Thomson, PO Box N910, Sydney, NSW	200.00	''	27/10/00
Marilyn Joyce Roberts, 20 Neville Road, Bridgeman Downs, Qld	136.40	''	''
Michael Roy Roberts & Sally Heather Roberts, 1 Shortland Crescent, Ainslie, ACT	100.00	''	''
Bruce Samuel Roberts, 20 Neville Road, Bridgeman Downs, Qld	140.00	''	''
Brett Charles Roberts, 20 Neville Road, Bridgeman Downs, Qld	136.40	''	''
Angela Roberts, 21 Wanaka Drive, Taylors Lakes	100.00	''	''
Euta Roberts, 51 Dalmar Street, Croydon, NSW	256.00	''	28/04/00
William Daniel Charles Roberts & Margareth Vorm Michaelsen, 33 Braeside Road, Katanning, WA	120.00	''	27/10/00
Miss Bonnie Roberts, PO Box 189, Newport Beach, NSW	101.00	''	''
Mr James Feilding Roberts, 12 Durville Crescent, Griffith, ACT	140.00	''	''
Peter James Robertson, 9 Horizon Place, Dubbo, NSW	100.00	''	''

Robert Herbert Robertson, PO Box 17, Ringwood	200.00	''	''
Alan John Robertson & Lyn Gail Robertson, 4 Mostyn Place, Warnbro, WA	100.00	''	''
John Robertson, "Staff Fund A/c", 4 Burchill Street, Loganholme, Qld	181.30	''	28/04/00
John Robertson, "Staff Fund A/c", 4 Burchill Street, Loganholme, Qld	300.00	''	27/10/00
John Robertson, 46/26 Lower River Terrace, South Brisbane, Qld	185.75	''	28/04/00
John Robertson, 46/26 Lower River Terrace, South Brisbane, Qld	308.00	''	27/10/00
Mrs Pauline Margaret Robertson, 20/28 Hampton Road, Fremantle, WA	100.00	''	''
Maria Louise Robertson & Jane Alezia Cooper, PO Box 152, Fortitude Valley, Qld	100.00	''	''
John Robertson, 49 Stanhill Drive, Chevron Island, Qld	100.00	''	''
Simon Nicolas George Robinson, 3/54 Seaview Road, Port Augusta, SA	169.60	''	28/04/00
Simon Nicolas George Robinson, 3/54 Seaview Road, Port Augusta, SA	212.00	''	27/10/00
Jeffrey Heatley Robinson, C/- Ove Arup & Partners, 79 Franklin Street, Melbourne	228.00	''	28/04/00
Jeffrey Heatley Robinson, C/- Ove Arup & Partners, 79 Franklin Street, Melbourne	285.00	''	27/10/00
Mr Stephen John Robinson & Mr Mark Edward Robinson, 39 Main Road, Lower Plenty	140.00	''	''
Jane Robinson, "Phillips Henderson Ward A/c", GPO Box 2419, Adelaide, SA	100.00	''	''
Katherine Robinson, 13/2 Raglan Street, Mosman, NSW	100.00	''	''
Sarah Robson, 16 Jackson Street, Balgowlah, NSW	144.95	''	28/04/00
Sarah Robson, 16 Jackson Street, Balgowlah, NSW	240.00	''	27/10/00
Mrs Heidi Marie Roche, Unit 13, 128 Carrington Road, Randwick, NSW	100.00	''	''
Fiona Roche, C/- Estates Development Co, PO Box 329, Nedlands, WA	100.00	''	''
Mr Keiron Peter Rochester, 3 Huon Place, Illawong, NSW	455.00	''	''
Rockleigh Engineering Pty Ltd, PO Box 189, Mt Eliza	100.00	''	''
Roderic Pty Limited, 11/10 The Avenue, Crawley, WA	100.00	''	''
David Rodgers, 75 Waverley Street, Moonee Ponds	217.20	''	28/04/00
David Rodgers, 75 Waverley Street, Moonee Ponds	360.00	''	27/10/00
Mr Richard Anthony Rodgers, GPO Box 353, Canberra, ACT	100.00	''	''
Paul Rodighiero, PO Box 1240, Carlton	160.00	''	28/04/00
Paul Rodighiero, PO Box 1240, Carlton	200.00	''	27/10/00
Mrs Zhenyu Roebuck, 14/148 Dean Street, Strathfield South, NSW	100.00	''	''
Timothy Alan Roediger, 65 Smith Street, Wollongong, NSW	160.00	''	''
Wendy Joy Roehner, "John R. & Mark A. Roehner A/c", 69 Kent Road, Hamilton	160.00	''	28/04/00
Izidor Roessler, 18 Howard Avenue, Ormond	176.00	''	''
Izidor Roessler, 18 Howard Avenue, Ormond	220.00	''	27/10/00
Mr Peter Roff-Smith, 4 North Street, Richmond	160.00	''	28/04/00
Mr Peter Roff-Smith, 4 North Street, Richmond	200.00	''	27/10/00
Jeffrey Bernard Rogers, 10 Faraday Avenue, Rose Bay, NSW	144.95	''	28/04/00

Jeffrey Bernard Rogers, 10 Faraday Avenue, Rose Bay, NSW	240.00	''	27/10/00
Jason Rogers, PO Box 1530, Double Bay, NSW	100.00	''	''
Peter Keville Rogers & Denise Ann Taylor, 8 Royle Street, Chittaway Point, NSW	200.00	''	''
Allan Streeter Rogers, 36 Green Street, Spalding, WA	100.00	''	''
Tricia Ann Rogers, 36 Green Street, Spalding, WA	100.00	''	''
Rohtak Pty Ltd, 14 Westminster Avenue, Bulleen	300.00	''	''
Mrs Katrina Rolando, PO Box 96, Silvan	314.40	''	28/04/00
Ms Sybil Gertrude Roman, "Zac Sophie & Sam Epstein A/c", 4/37 Reddall Parade, Lake Illawarra South, NSW	150.00	''	27/10/00
David Romans, 1 Cypress Avenue, Glen Alta, SA	112.00	''	28/04/00
Ron Gee Enterprises Pty Ltd, "Ron Gee Enterprises Super A/c", PO Box 200, Penguin, Tas.	192.00	''	''
Rosalind Mulroney, 1 Narkunda Street, Glandore, SA	164.00	''	27/10/00
Daniel Rose, 14A Bickell Road, Mosman, NSW	100.00	''	''
Mr Simon Peter Rose, 18 Kildare Grove, Killarney Heights, NSW	100.00	''	''
Mrs Leanne Margaret Rose, PO Box 1743, Crows Nest, NSW	686.00	''	''
Paul Maurice Rosenberg & Nancye Fay Alper, PO Box 622, Elsternwick, Jacob Rosenberg, "Shoshana Jacobs A/c", 11 Wanda Road, Caulfield	100.00	''	''
Jacob Rosenberg, 11 Wanda Road, Caulfield	100.00	''	''
Esther Rosenberg, 11 Wanda Road, Caulfield	100.00	''	''
Adam James Rosewarne & Timothy Elward Rosewarne, 6 Kingfisher Crescent, Grays Point, NSW	100.00	''	''
Boleslaw Rosiak, 24 Hemming Street, Penrith, NSW	200.00	''	''
Aniela Rosiak, 24 Hemming Street, Penrith, NSW	200.00	''	''
Flora Roso, 5 Johnston Street, Thomastown	100.00	''	''
Malcolm John Ross, 65 Cricklewood Road, Aldgate, SA	100.00	''	''
Miss Viviana Rossi, 22 Aylmer Street, Balwyn North	102.40	''	28/04/00
Trevor Francis Rossington, PO Box 363, Leeton, NSW	120.00	''	27/10/00
Martin Magnus Rotsey, 18 Gerald Avenue, Roseville, NSW	115.00	''	''
Mrs Fiona Ann Roughley, 3 Camdre Court, Cleveland, Qld	100.00	''	''
Mr John Alfred Rowan, PO Box 4273, Sydney, NSW	500.00	''	''
John Alfred Rowan, GPO Box 4273, Sydney, NSW	120.70	''	28/04/00
John Alfred Rowan, GPO Box 4273, Sydney, NSW	200.00	''	27/10/00
Robin Nardi Rowe, 106 Junction Road, Wahroonga, NSW	244.00	''	''
Darlene Lynnette Rowe, 42 Teagarden Street, Eight Mile Plains, Qld	100.00	''	''
Mr David Jonathon Rowe, 15/13 Belmont Avenue, Wollstonecraft, NSW	120.00	''	''
Trevor Ronald Rowland & Denise Phi-Phuong Rowland, 35 Glen Nevis Street, Mansfield, Qld	144.00	''	28/04/00
Trevor Ronald Rowland & Denise Phi-Phuong Rowland, 35 Glen Nevis Street, Mansfield, Qld	180.00	''	27/10/00
Linda Marjorie Rowley & Christopher Gerard Rowley, 3/18 Woods Parade, Fairlight, NSW	120.00	''	''
Ms Elisabeth Marie-Louise Rowley, C/- Behrens Rowley & Co, PO Box 2350, North Parramatta, NSW	100.00	''	''
Mr Jef John Shaw Rowlison, 26 Montclair Avenue, Brighton	100.00	''	''
Tanya Roxas, 62 Telfer Road, Castle Hill, NSW	136.00	''	28/04/00

Roula Rozakeas, 32 Turner Street, Pascoe Vale South	100.00	''	27/10/00
Divinia Rubin, 36 Burley Road, Padstow, NSW	100.00	''	''
Rubira Investments Pty Limited, "Rubira S/F A/c", C/-Reardon & Associates, 15 Cobden St, North Melbourne	165.00	''	''
Richard Rudas, 175 Ryecroft Road, Darlington, WA	160.00	''	28/04/00
Mr Garry J Ruge, 199 Oakvale Road, Cuddletown, NSW	250.00	''	27/10/00
Ruth Maria Ruhl, 5 Morrison Court, Mount Waverley	168.00	''	''
Rupanyup Pty Ltd, "Super Fund A/c", 673 West Street, Toowoomba, Qld	100.00	''	''
James Mitchell Rushton & J. M. Rushton & Co Solicitors, 43 Walker Avenue, Haberfield, NSW	327.00	''	''
Shah Rusiti, "James Rusiti A/c", 30 Second Avenue, Willoughby, NSW	110.00	''	''
Joni Rusli, 27 Newton Street, Kensington	100.00	''	''
Ms Rosemary Ann Russell, 15 Hartland Way, Warnbro, WA	200.00	''	''
Amanda Rust, 51 Luxmoore Street, Cheltenham	160.00	''	''
Mr David Rutledge, GPO Box 738, Brisbane, Qld	120.70	''	28/04/00
Diana Lucy Rutter, 119 Hursville Road, Oatley, NSW	100.00	''	27/10/00
RW Leete Pty Ltd, "Provident Fund A/c", PO Box 61, Tumbi Umbi, NSW	160.00	''	28/04/00
RW Leete Pty Ltd, "Provident Fund A/c", PO Box 61, Tumbi Umbi, NSW	200.00	''	27/10/00
Mr Keith Ryan, PO Box 16, Jesmond, NSW	128.00	''	28/04/00
Kevin Ryan, 2/174 Phillip Street, Sydney, NSW	100.00	''	27/10/00
Emily Ryan, 120 Fitzroy Street, Cowra, NSW	120.00	''	''
John Francis Ryan, PO Box 391, Muswellbrook, NSW	100.00	''	''
Joan Lesley Rybalka, RMB 1130, Grandridge Road, Boolarra South	160.00	''	''
Ryde Motor Group Pty Ltd, "Super Fund A/c", PO Box 705, Ryde, NSW	169.20	''	28/04/00
Ryde Motor Group Pty Ltd, "Super Fund A/c", PO Box 705, Ryde, NSW	280.00	''	27/10/00
Rydecal Pty Limited, "Super Fund A/c", PO Box 705, Ryde, NSW	385.90	''	28/04/00
Rydecal Pty Limited, "Super Fund A/c", PO Box 705, Ryde, NSW	640.00	''	''
S. B. Slacks Pty Limited, 16 Alexander St, Paddington, NSW	260.00	''	''
S. J. Opie & Associates Pty Ltd, "S. J. Opie Family A/c", 77 Freemantle Drive, Wantirna South	128.00	''	28/04/00
S. J. Opie & Associates Pty Ltd, "S J Opie Family A/c", 77 Freemantle Drive, Wantirna South	160.00	''	27/10/00
Laura Saade & Samir Saade & Kelly Saade, 29 South Street, Strathfield, NSW	128.00	''	''
Edward Saade & Benoir Saade & Kelly Saade, "E & B Saade Ac", 32 Howard Street, Strathfield, NSW	108.00	''	''
Michael J. Sabada, 93 Cobden Street, South Melbourne	157.05	''	28/04/00
Michael Sabadb, 7 Wirraway Court, Ashburton	150.00	''	27/10/00
Terence Bernon Saddington, "John Hubert Saddington A/c", 7 The Grove, Frankston	100.00	''	''
Florence Margaret Saddington, 7 The Grove, Frankston	100.00	''	''
Mr Vernon Saddington, 125 Nepean Highway, Seaford	120.70	''	28/04/00
Mr Vernon Saddington, 125 Nepean Highway, Seaford	200.00	''	27/10/00
Dr Joel Sadowsky, 1/39 Narong Road, Caulfield North	100.00	''	''

Sail & Steam Pty Ltd, "The Ross Super Fund A/c", 83 Mary Street, Highgate, WA	1,000.00	"	"
Saint Nominees Pty Ltd, "Roles Family A/c", PO Box R1474, Royal Exchange, Sydney, NSW	100.00	"	"
Mrs Cheryl Sainty, 12 Bangalla Street, Warrawee, NSW	160.00	"	28/04/00
Chieko Sakae & Takashi Sakae, 701/5 Jersey Road, Artarmon, NSW	100.78	"	"
Chieko Sakae & Takashi Sakae, 701/5 Jersey Road, Artarmon, NSW	166.60	"	27/10/00
Gani Sakiri, 379 Naoier Street, Fitzroy	120.70	"	28/04/00
Eduard Sakkers, 33 Gwendoline Street, Mt Gambier, SA	100.00	"	27/10/00
John Francis Salamito, 329A Canterbury Road, St Kilda	120.70	"	28/04/00
John Francis Salamito, 329A Canterbury Road, St Kilda	200.00	"	27/10/00
Stephen J. Salamon, 4 Boucaut Street, Clapham, SA	110.00	"	"
Gordon Albert Salier, 38 Ellery Parade, Seaforth, NSW	250.00	"	"
Mr Jorge Salles & Mrs Elizabeth Marie Salles, 79 Coventry Circuit, Carindale, Qld	100.00	"	"
Darren Ashley Sallmann, 45 Warleigh Grove, North Brighton	100.00	"	"
Michele Salvatore & Est Carmela Salvatore, 14 Greta Street, Clayton	144.00	"	28/04/00
Luana Salvitti, 23 Venice Avenue, Mitcham	100.00	"	27/10/00
Gervin Samarawickrama & Sunethra Samarawickrama, PO Box 40819, Casuarina, NT	120.00	"	"
Estate Andrew Same, 6 Briggs Street, Balwyn North	100.00	"	"
Myer Samra, "Suzette Shoshana Samra A/c", 241 Military Road, Dover Heights, NSW	100.00	"	"
Adele Samra, 33 Dillon Street, Paddington, NSW	160.00	"	28/04/00
San & Co Pty Ltd, "Super Fund A/c", 1 Karawatha Place, O'malley, ACT	420.00	"	"
San & Co Pty Ltd, "Super Fund A/c", 1 Karawatha Place, O'malley, ACT	525.00	"	27/10/00
Chooi San Beh, 20 Alex Avenue, Wheelers Hill	110.00	"	"
San Lin, 87/1 Katherine Street, Chatswood, NSW	292.45	"	28/04/00
Sandbar Pty Ltd, Level 2 111 Collins Street, Melbourne	640.00	"	"
Sandbar Pty Ltd, Level 2 111 Collins Street, Melbourne	800.00	"	27/10/00
Volker Sander, PO Box 114, Weipa, Qld	140.00	"	"
Miss Louise Alison Sandercock, 423 Coode St, Dianella, WA	100.00	"	"
Estate Ronald Clarence Sanders, C/- Tetlow Jansen and Doyle, PO Box 583, Dickson, ACT	560.00	"	"
Charles William Sanders, 7/23 Chapman Street, North Melbourne	160.00	"	28/04/00
Charles William Sanders, 7/23 Chapman Street, North Melbourne	200.00	"	27/10/00
Angela Sanders, "Alyssa Bond A/c", 25 Tandarook Crescent, Donvale	131.00	"	"
Robert John Sanders, 5 Cochrane Street, Camira, Qld	150.00	"	"
Kerrie L. Sanders, 58 Pozieres Parade, North Manly, NSW	313.65	"	28/04/00
Kerrie L. Sanders, 58 Pozieres Parade, North Manly, NSW	520.00	"	27/10/00
Paul T. Sanders, 5/259 Canterbury Road, Heathmont	432.00	"	28/04/00
Paul T. Sanders, 5/259 Canterbury Road, Heathmont	540.00	"	27/10/00
Beverley Sue Sanderson, 7 Byron Avenue, St Ives, NSW	100.00	"	"
Nathan D Sandilands, 24 Kauri Drive, Gladstone, Qld	250.00	"	"
Rachel Sands, 54 Chelmsford Road, Mount Lawley, WA	200.00	"	"

Masfufah Sani, 156 Eastern Avenues, Kingsford, NSW	192.00	''	28/04/00
Masfufah Sani, 156 Eastern Avenues, Kingsford, NSW	240.00	''	27/10/00
Amitia Sanip & Aminuddin Sanip & Fachril Sanip, 3 Craigavad Street, Carnegie	120.00	''	''
Arnel Santiano & Antonia Santiano, 2 Rolland Court, Melton South	140.00	''	''
Franco Santucci & Susan Banks, "The Trinity Super Fund A/c", 7/6 Webb Lane, East Melbourne	440.00	''	28/04/00
Franco Santucci & Susan Banks, "The Trinity Super Fund A/c", 7/6 Webb Lane, East Melbourne	550.00	''	27/10/00
Tate Sapiatzer, 6 Norman Street, Paradise, SA	268.00	''	''
Ivan Saracik & Jennifer Saracik, 51 Railway Parade, Mount Lawley, WA	200.00	''	''
Oliver Charles Sargent, 5 Freeman Street, Hawthorn	150.00	''	''
Darren Lee Sargeson, 28/90 Digger Street, Cairns, Qld	120.70	''	28/04/00
Darren Lee Sargeson, 28/90 Digger Street, Cairns, Qld	200.00	''	27/10/00
Mr Paul Sarks, "Anne-Louise Sarks A/c", 3 Malvern Crescent, Strathfield, NSW	100.00	''	''
Carmel Sarks, "Madeleine Sullivan A/c", 3 Malvern Cres, Strathfield, NSW	100.00	''	''
Carmel Sarks, 3 Malvern Cres, Strathfield, NSW	100.00	''	''
Mario T. Sarno, 16 Malouf Place, Blacktown, NSW	108.60	''	28/04/00
Mario T. Sarno, 16 Malouf Place, Blacktown, NSW	180.00	''	27/10/00
Maryanne Sasso, PO Box 419, Merrylands, NSW	173.67	''	28/04/00
Maryanne Sasso, PO Box 419, Merrylands, NSW	287.40	''	27/10/00
Nicholas*Andrew F. Satterly, Unit 2, 57 May Street, Fitzroy North	120.70	''	28/04/00
Nicholas*Andrew F. Satterly, Unit 2, 57 May Street, Fitzroy North	200.00	''	27/10/00
Peter John Saul, 5 Allars Street, Denistone West, NSW	100.00	''	''
Alexander Saul & Doreen Saul, 8 Stewart Place, Glenmore Park, NSW	100.00	''	''
Peter J. Saul, 5 Allars Street, Denistone, NSW	625.60	''	28/04/00
Peter J. Saul, 5 Allars Street, Denistone, NSW	782.00	''	27/10/00
Berris Saultry, 70 Coventry St, South Melbourne	100.00	''	''
Munro Rowley Saunders, PO Box 192, Erskineville, NSW	190.00	''	''
Joyce Saunders, 108 Kalinga Street, Ballina, NSW	192.00	''	28/04/00
Katherine Jane Saunders, 9 Hutchinson Ave, Athelstone, SA	110.00	''	27/10/00
John C. Saunders, 9 Hutchinson Ave, Athelstone, SA	110.00	''	''
Stephen H. Saunders, 28 Sassafra Street, The Gap, Qld	300.00	''	''
Mr Marcus Anthony Savill, Unit 11, 60 Acacia Way, South Hedland, WA	128.00	''	28/04/00
Stephanie Saville, PO Box 2073, Rose Bay North, NSW	100.00	''	27/10/00
Alexandra Saville, PO Box 2073, Rose Bay North, NSW	100.00	''	''
Annemarie Savoria, 12 Daniel Street, Donvale	176.00	''	28/04/00
Annemarie Savoria, 12 Daniel Street, Donvale	220.00	''	27/10/00
Arthur John Saw, 3 Wills Street, South Yunderup, WA	100.00	''	''
Roman Peter Sawko, 2 Adelaide Street, St Albans	126.99	''	28/04/00
Roman Peter Sawko, 2 Adelaide Street, St Albans	210.30	''	27/10/00
Graeme D. Sawtell, 40 North East Crescent, Lilli Pilli, NSW	256.00	''	28/04/00
Graeme D. Sawtell, 40 North East Crescent, Lilli Pilli, NSW	320.00	''	27/10/00

Chanthamaly Sayasane, 51 Moorookyle Avenue, Hughesdale	100.00	''	''
David Sayer, "Djs Family Super Fund A/c", 124 Glenhaven Road, Glenhaven, NSW	102.40	''	28/04/00
SB Carlin Pty Ltd, 169 Karrinyup Road, Karrinyup, WA	320.00	''	''
SB Carlin Pty Ltd, 169 Karrinyup Road, Karrinyup, WA	400.00	''	27/10/00
Santo Scalora, 30 Narina Way, Epping	100.00	''	''
Michelle Scalora, 30 Narina Way, Epping	160.00	''	''
Maria Scalora, 30 Narina Way, Epping	100.00	''	''
Miss Anne Maureen Scarff, 8 Paulwood Avenue, Winmalee, NSW	120.00	''	''
Christian Anthony Schalken & Mechelina Gerarda Schalken, 11 Maroondah Highway, Lilydale	120.00	''	''
Anita F. Schaller, Po Box 144, Parap, NT	340.00	''	''
Carmelo Schembri & Carmen Schembri, Po Box 288, Altona	100.00	''	''
Con Joseph Schembri, 18/34 Kiora Road, Miranda, NSW	120.70	''	28/04/00
Con Joseph Schembri, 18/34 Kiora Road, Miranda, NSW	200.00	''	27/10/00
Cindy Schille, 5 Avoca Court, Croydon	100.00	''	''
Schizophonia Productions Pty Ltd, C/- Unit 26, 14 Royston Street, Kings Cross, NSW	400.00	''	28/04/00
Mr David Schlessinger, 65 Portland St, Dover Heights, NSW	120.00	''	27/10/00
Ms Mary Gwenda Schlicht, PO Box 25, Camperdown	220.00	''	''
Michael Schneider, 21 Finlay Road, Warrawee, NSW	169.60	''	28/04/00
Michael Schneider, 21 Finlay Road, Warrawee, NSW	212.00	''	27/10/00
Robert Thomas Schnitzer, 50 Edinburgh Rd, Castlecrag, NSW	100.00	''	''
Mr David Andrew Scholes & Mrs Diana Christine Scholes, C/- PO Box Y3046, Perth East, St Georges Terrace, WA	240.00	''	''
Maarten Pieter Schotte, 13 Banksia Broadway, Burleigh Heads, Qld	160.00	''	28/04/00
Maarten Pieter Schotte, 13 Banksia Broadway, Burleigh Heads, Qld	200.00	''	27/10/00
Andrew Peter Schultz & Tiffany Louise Panther-Schultz, 31 Christopher Drive, Frankston	100.00	''	''
Mr Neville Owen Schulz, PO Box 6, Swan Reach, SA	100.00	''	''
Christopher John Schumacher, PO Box 3330, Australia Fair, Qld	100.00	''	''
Darren John Schunke, 39 Kilgaritt Crescent, Alice Springs, NT	100.00	''	''
Estelle Schwab, PO Box 105, Brighton	100.00	''	''
Roberto Nunzio Sciacca, 69 Donald Street, Hurstville, NSW	200.00	''	''
Victor Scognamiglio, 40 Jeanette Street, East Ryde, NSW	100.00	''	''
John Arthur Roy Scorey, 16 Alt Street, Smithfield, NSW	100.00	''	''
Michael Scott, 64 Hudson Street, Bayswater, WA	120.00	''	''
Anthony John Scott, 11 Lookes Avenue, Balmain, NSW	186.90	''	28/04/00
Anthony John Scott, 11 Lookes Avenue, Balmain, NSW	310.00	''	27/10/00
Mr Brandon Scott, 10 Hampden Road, Pennant Hills, NSW	100.00	''	''
Scott Banks Real Estate Group Pty Ltd, "Atfbanks A/c", 214 Blackburn Road, Mount Waverley	180.00	''	''
Brian Scoullar, 136 Warrandyte Road, Ringwood	100.00	''	''
Mr Graham Edward Scrymgeour, 55 Victoria Street, Malabar, NSW	100.00	''	''
Peter Scully, Unit 8, 22 Kingston Road, Camperdown, NSW	108.00	''	''
Seabloc Pty Ltd, 2/174 Phillip Street, Sydney, NSW	100.00	''	''
Mr Samuel Seabury, GPO Box 5193AA, Melbourne	120.70	''	28/04/00

Ms Jaynie Lee Seal, PO Box 688, Spit Junction, NSW	130.00	''	27/10/00
Brenton Neil Searle, 14/38 Bootle Place, Phillip, ACT	100.00	''	''
Renae Searle, Unit 77, 30 Nobbs Street, Surry Hills, NSW	242.00	''	''
Ilan Sebban & Shira Sebban, 3/88-90 Murriverie Road, North Bondi, NSW	157.05	''	28/04/00
Ilan Sebban & Shira Sebban, 3/88-90 Murriverie Road, North Bondi, NSW	260.00	''	27/10/00
Emma Seberry, 18 Austin Street, Fairlight, NSW	160.00	''	''
Connie See, 69 The Grove, Fairfield, NSW	100.00	''	''
Mark Seeckts & Angela Seeckts, "Seeckts Super Fund A/c", 61 Percy Street, Newtown	120.00	''	''
Jeremy Wing-Chee Seeto & Felicity Yvonne Seeto, 10 Northview Terrace, Mackay, Qld	257.00	''	''
Thomas Quentin Seeto, 6 Eisenhower Street, Stretton, Qld	164.25	''	28/04/00
Thomas Quentin Seeto, 6 Eisenhower Street, Stretton, Qld	272.00	''	27/10/00
Mr Gregory Wayne Segal, 1/62 Cross St, Double Bay, NSW	120.70	''	28/04/00
Eric Sekula, 9 Symonds Avenue, North Parramatta, NSW	100.00	''	27/10/00
Robyn Selby, 51 Bundeena Road, Woodbine, NSW	120.00	''	''
Kenneth W Sell, 5 Norbury Way, Langford, WA	110.00	''	''
Philip Norman Sellars, 7 Courtice Close, Fadden, ACT	300.00	''	''
Julie Lee Sellars, 7 Courtice Close, Fadden, ACT	320.00	''	''
Gordan Selleck & Maria Selleck, 87 Dumass Street, McKellar, ACT	108.00	''	''
Ross Lincoln Selman, 34a Gordon Street, Mosman, NSW	100.00	''	''
Keir Semmens, 16/18 Golden Avenue, Chelsea	192.00	''	28/04/00
Margel Zufferey Senior & Stefanie Zufferey, PO Box 119, Darlinghurst, NSW	140.00	''	''
Margel Zufferey Senior & Stefanie Zufferey, PO Box 119, Darlinghurst, NSW	232.00	''	27/10/00
Separation Engineers Pty Ltd, C/- Garrotts, 62 Paterson Street, Launceston, Tas.	100.00	''	''
Serlett Pty Limited, 30 Pindari Avenue, Mosman, NSW	100.00	''	''
Anne Serry, 13 Erindale Avenue, Elsternwick	100.00	''	''
Ronald Serry, 13 Erindale Avenue, Elsternwick	100.00	''	''
Hs Custom Serve, 47 Falcon Street, Crows Nest, NSW	300.80	''	28/04/00
Mr Gurmeet Singh Sethi & Mrs Gaganjit Kaur Sethi, 15 Rostella Court, Wheelers Hill	100.00	''	27/10/00
Usha Kiran Sewak & Pratap Chandra Sewak, 263 Karoo Road, Ferntree Gully	100.00	''	''
Ben Sewell, 104 Lyons North, Ballarat	100.00	''	''
Mr Paul Sewell, PO Box W86, Wanniasa, ACT	100.00	''	''
Miss Jill Robyn Jan Sewell, McIntyre Road, Nayook	241.45	''	28/04/00
Kenneth Paul Seymour, PO Box 2774, Cheltenham	100.00	''	27/10/00
Nina Louise Seymour, 9/35 Shirley Rd, Wollstonecraft, NSW	100.00	''	''
Mark Shackel, 34 O'Flynn Street, Lismore Heights, NSW	100.00	''	''
Shadlare Pty Ltd, 8 Susan Close, River Heads, Qld	100.00	''	''
Hardika Shah & Balam Shivaraman, 13/170 Spit Road, Mosman, NSW	160.00	''	''
Sadie Shalala, 58 Albyn Road, Strathfield, NSW	150.00	''	''
Adib Shalala, 58 Albyn Road, Strathfield, NSW	150.00	''	''
Andrew James Shalders, 8 Clive Street, Bicton, WA	100.00	''	''
Brenda Joan Shammall, 14 Donald Street, Highbury, SA	200.00	''	''
Robin Jan Lloyd Shand,			

685 New South Head Road, Rose Bay, NSW Mr Leslie Shank & Mrs Josephine Shank,	162.00	''	28/04/00
32/24 Rangers Road, Cremorne, NSW Mrs Deborah Shanley, 51 Kangeroo Road, Murrumbena David Gerard Shannon,	721.20	''	27/10/00
23 Hopetoun Close, Port Macquarie, NSW	200.00	''	''
Roy Shannon, 7 Islip Place, Woodlands, WA	160.00	''	''
Francis Patrick Shannon, 12 Seymour Street, Preston	100.00	''	''
Liza Wendy Shar, 19 Elvina Street, Dover Heights, NSW	248.00	''	''
Liza Wendy Shar, 19 Elvina Street, Dover Heights, NSW	120.70	''	28/04/00
Vinay Sharma, 3 Begonia Court, Endeavour Hills	200.00	''	27/10/00
Mr Vidya S. Sharma & Mrs Glenys J. Sharma, "Sharma S/F A/c", 2 Downing Street, Blackburn	140.00	''	''
Mr Vidya S. Sharma & Mrs Glenys J. Sharma, "Sharma S/F A/c", 2 Downing Street, Blackburn	134.40	''	28/04/00
John Richard Sharman, 1077 Yarramba Crescent, Albury North, NSW	168.00	''	27/10/00
John Richard Sharman, 1077 Yarramba Crescent, Albury North, NSW	102.40	''	28/04/00
Mr Nathan Sharpe, 2/15 Brasted Street, Taringa, Qld	128.00	''	27/10/00
James Sharpe, Bevington Shores, Lot 37 Sunrise Avenue, Budgewoi, NSW	100.00	''	''
Barry Archibald Shaw, 29 Brown Avenue, Ascot Vale	240.00	''	''
Ms Katie Shaw, 41 The Boulevard, Floreat, WA	100.00	''	''
Graeme Desmond Shaw & Susan Lynda Shaw, PO Box 888, Queenstown, New Zealand	130.00	''	''
Mr Brendan Shaw, "BV&J Shaw Retirement Fund A/c", PO Box 464, Kew	152.00	''	28/04/00
Mr Brendan Shaw, "BV&J Shaw Retirement Fund A/c", PO Box 464, Kew	190.00	''	27/10/00
Ms Dianne J Shaw, 3 Beecroft Road, Pennant Hills, NSW	288.00	''	28/04/00
Mr Alexander Thomas Shedden & Mr William Linney Shedden, "Willex Super Fund A/c", 8 McAuley Drive, Rosanna	200.00	''	27/10/00
Sheerline Solutions Pty Ltd, 4/24 Boyle St, Cremorne, NSW	127.90	''	28/04/00
Sheerline Solutions Pty Ltd, 4/24 Boyle St, Cremorne, NSW	212.00	''	27/10/00
Melanie Sheffield, GPO Box K6842, Perth, WA	128.00	''	28/04/00
Melanie Sheffield, GPO Box K6842, Perth, WA	160.00	''	27/10/00
Ilksel Shefket, 10 Penguin Parade, Hinchinbrook, NSW	100.00	''	''
Mr David Sheldon, 29 Kuranda Street, Balmoral, Qld	181.30	''	28/04/00
Mr David Sheldon, 29 Kuranda Street, Balmoral, Qld	300.00	''	27/10/00
Shellys Pty Ltd, 3/11 Soldiers Ave, Harbord, NSW	100.00	''	''
Pei Ling Shen, 25 Beatty Crescent, Queanbeyan, NSW	100.00	''	''
Ms Li Shen, 4/32 Beaconsfield Street, Bexley, NSW	550.00	''	''
Ms Li Shen, Unit 4, 32 Beaconsfield Street, Bexley, NSW	300.00	''	''
Jon Roderic Shepherd, Level 19, Grosvenor Place, 255 George Street, Sydney, NSW	241.45	''	28/04/00
Jon Roderic Shepherd, Level 19, Grosvenor Place, 255 George Street, Sydney, NSW	400.00	''	27/10/00
Michael Andrew Sheppard, PO Box 64, Willoughby, NSW	102.55	''	28/04/00
Michael Andrew Sheppard, PO Box 64, Willoughby, NSW	170.00	''	27/10/00
Robyn Lea Sheptooha, 7 Neulans Rd, Indooroopilly, Qld	100.00	''	''
Charles Philip Shergold, 33 Sussex St, North Adelaide, SA	100.00	''	''

Ms Rachel Shergold, 38 Sussex Street, North Adelaide, SA	100.00	''	''
Tom Sheridan, 13 Trevor Street, Turvey Park, NSW	140.00	''	''
Terrence Errol Sheridan, 8774 Route 45, North Bloomfield, Ohio 44450 USA	200.00	''	''
Mr Nigel Bruce Sheridan-Smith, 1/45 Burton Street, Concord, NSW	100.00	''	''
Kristen Sherlock, Unit 10, 296 Inkerman Street, St Kilda East	115.00	''	''
Melanie Jane Sherrin, 43/22 Archibald Street, Lyneham, ACT	160.00	''	''
Peter Scott Sherrington & Jannine Annette Webb, 82 Flinders Street, Mt Hawthorn, WA	128.00	''	28/04/00
Can Shevket, 150 Johns Road, Wadalba, NSW	100.00	''	27/10/00
Wei Wei Shi, PO Box K1113, Haymarket, NSW	192.00	''	28/04/00
Jeffrey Alan Shields, PO Box 3015, North Ivanhoe	100.00	''	27/10/00
Mr Patrick George Shiels, Commercial Hotel, 34 Martin Street, Stockinbingal, NSW	160.00	''	28/04/00
Peter Mark Shipman, PO Box 605, Heathmont	250.00	''	27/10/00
Hideo Shirakawa, C/- Chieko Stockden, 3 Vance Street, Thornlie, WA	192.95	''	28/04/00
Hideo Shirakawa, C/- Chieko Stockden, 3 Vance Street, Thornlie, WA	420.00	''	27/10/00
Glenn Raymond Shirley, 25 Pitt Street, Kensington, WA	120.70	''	28/04/00
Glenn Raymond Shirley, 25 Pitt Street, Kensington, WA	200.00	''	27/10/00
Hamideh Shokouhi, 1/27 Laurel Avenue, Boronia	128.20	''	''
Barry Wilson Short, 3 Camdon Gardens, Berwick	200.00	''	''
Mr Geoffrey James Short, 11 Priory Avenue, Chiswick W4ITX, London, United Kingdom	125.00	''	''
Bruce Shortland-Jones, 55 Marsengo Road, Bateman, WA	100.00	''	''
Showcase Solutions Pty Ltd, "Super Fund A/c", 21/160 Wattletree Road, Malvern	100.00	''	''
Shrimps Clothing Company Pty Ltd, 12 Malakoff Street, North Caulfield	100.00	''	''
Lan Chun Shum, 30 Wellington Square, North Adelaide, SA	100.00	''	''
Selma Shun, 87 Denison Street, Rozelle, NSW	120.00	''	28/04/00
Mr Nitin Sibal, 141/398 Pitt Street, Sydney, NSW	482.35	''	''
Mr Nitin Sibal, 141/398 Pitt Street, Sydney, NSW	400.00	''	27/10/00
Mr Frank Sicari & Mrs Susan Ann Sicari, "Brighton Bay Exec S/F A/c", Unit 3, 48 The Esplanade, Brighton	300.00	''	''
James Angus Sides, 125 End Street, Deniliquin, NSW	100.00	''	''
Mr Kevin Gerard Siebel & Ms Tanya Jean Siebel, 41 Fairfield Gardens, Canning Vale, WA	100.00	''	''
Jean Louise Siekmann & Thomasina Rose Siekmann, PO Box 232, Crafers, SA	120.00	''	''
John Sieler, 17 Brayton Road, Marulan, NSW	100.00	''	''
Gary David Signoretto, 155 Jacaranda Ave, Kingston, Qld	151.00	''	28/04/00
Gary David Signoretto, 155 Jacaranda Ave, Kingston, Qld	250.00	''	27/10/00
Janet Isabella Silburn, 20 Magnolia Crescent, Esperance, WA	100.00	''	''
Leandro Silva, 1/216 Miller St, Fitzroy North	100.00	''	''
Silver Arch Pty Ltd, "Clayden Super Fund A/c", 230 St Brigids Terrace, Doubleview, WA	116.00	''	''
Simach Investments Pty Ltd, "Super Fund A/c", 31 Farnham Street, Flemington	126.75	''	28/04/00
Susan Simencic, 14 Smith Street, Yagoona, NSW	100.00	''	27/10/00

Mr Michael Simeon & Mrs Maureen Kay Simeon, 120 Bombay Street, Lidcombe, NSW	157.05	”	28/04/00
Mr Michael Simeon & Mrs Maureen Kay Simeon, 120 Bombay Street, Lidcombe, NSW	260.00	”	27/10/00
Mr Mark Simich & Ms Ann Mary Hojsgaard, “M. F. R. Simich Family A/c”, Unit 2, Kalahari Palms, 32 William Street, Mermaid Beach, Qld	800.00	”	”
Debbie Simmons, “Lasocs Pty Ltd A/c”, 28 Trade Place, North Coburg	256.00	”	28/04/00
Margaret Simmons, “Andrew Edward Simmons A/c”, PO Box 134, Albert Park	100.00	”	27/10/00
Margaret Simmons, “Georgia Kate Simmons A/c”, PO Box 134, Albert Park	100.00	”	”
Mrs Margaret Simmons, “Georgia Kate Simmons A/c”, PO Box 134, Albert Park	100.00	”	”
Mrs Margaret Simmons, PO Box 134, Albert Park	160.00	”	”
Henry Simon, 19 Kinkora Road, Hawthorn	157.05	”	28/04/00
Henry Simon, 19 Kinkora Road, Hawthorn	260.00	”	27/10/00
Monique G Simonet, 3 Waverley Way, Parkwood, WA	106.00	”	”
Rita*Julia L. Simonet, 3 Waverley Way, Parkwood, WA	106.00	”	”
Danny Simons, 31 Ellindale Avenue, Mckinnon	100.00	”	”
Douglas Alexander Simpson, 36 Templemore Drive, Templestowe	100.00	”	”
Magdalen Oenone Simpson, 8 Chelmsford Avenue, Lindfield, NSW	133.00	”	”
Janette Michelle Simpson, 36 Templemore Drive, Templestowe	100.00	”	”
Dale Wendy Simpson & Scott Bruce Wheeler, 6/8 Cobbadah Street, O’Malley, ACT	100.00	”	”
John Richard Roy Simpson “Super Fund Ac”, Level 20, 1 Castlereagh Street, Sydney, NSW	100.00	”	”
Mr Ross Terence Simpson, 3 Bagleys Lane, Vermont	102.00	”	”
Maxwell J Simpson, PO Box 1673, Sunshine Plaza, Qld	105.00	”	”
Mr Robert John Simpson, 24 Harris Street, Penrith, NSW	273.00	”	”
Est Mary Fraser Simpson, 60 Shoobra Road, Elsternwick	268.00	”	”
Alice Sin, 20-24 Meagher Street, Chippendale, NSW	482.35	”	28/04/00
Cameron Scott Graham Sinclair & Annabel Tess Graham Sinclair, 35 Katina Street, Turrumurra, NSW	100.00	”	27/10/00
Raghubir Singh & Maxicare Medical Clinic Pty Ltd, PO Box 976, Campbelltown, NSW	240.00	”	”
Perminder Singh & Jasvinn Singh, 1 Claremont Street, Marylands, NSW	250.00	”	”
Sardul Singh, 2 Evesham Court, Bella Vista, NSW	100.00	”	”
Mr Mohan Singh, Block 1, #20–408 Tew Chew Street, 105, Singapore	328.86	”	28/04/00
Mr Mohan Singh, Block 1, #20–408 Tew Chew Street, 105, Singapore	445.00	”	27/10/00
Mr Ranbir Singh, 48 Thomas Street, Noble Park	120.96	”	28/04/00
Mr Ranbir Singh, 48 Thomas Street, Noble Park	151.20	”	27/10/00
Surinder Singh, F–146 Malcho Marg, Diplomatic Enclave, New Delhi 110 021, India	144.00	”	28/04/00
Tejbir Singh & Gurdey Singh, 70 Macleay St, Turner, ACT	120.00	”	27/10/00

Mr Perminder Singh, 2/1021 Rice Place, Oxley Park, NSW	100.00	''	''
Mr Mohan Singh, Blk 120A, Kim Tian Place, 25–26, Singapore 161120, Singapore	184.75	''	28/04/00
Satnam Singh, 84 Old Cleveland Road, Capalaba, Qld	169.20	''	''
Satnam Singh, 84 Old Cleveland Road, Capalaba, Qld	280.00	''	27/10/00
Seelan Singham, PO Box 74, Tallyho Post Office, Mt Waverley	400.00	''	28/04/00
Seelan Singham, PO Box 74, Tallyho Post Office, Mt Waverley	500.00	''	27/10/00
Mr Gopal Sinh & Mrs Archana Sinh, 1621 Riverdale Drive, Hope Island Resort, Qld	160.00	''	28/04/00
Mr Gopal Sinh & Mrs Archana Sinh, 1621 Riverdale Drive, Hope Island Resort, Qld	200.00	''	27/10/00
Achille Sinni, 325 Francis Street, Yarraville	120.00	''	''
Mrs Olga Sipek, 10 Bluegum Avenue, Prestons, NSW	100.00	''	''
Anna Maria Sipinkas, 14 Cassinia Street, Queanbeyan, NSW	140.00	''	''
Jennifer Anne Sitlington & Robert Reid Smith, 15 Mount Pleasant Road, West Preston	169.20	''	28/04/00
Rose Wan Heung Siu, 44 Timothy Drive, Wantirna South	138.90	''	''
Mr Kandasamy Sivaranjan, 36F 19–21 George Street, North Strathfield, NSW	250.00	''	27/10/00
Ms Annette Michele Skalej, “Elaine Montague S/Fund A/c”, 3 Graneel Grove, Berwick	100.00	''	''
Mr Michael Francis Skerrett, “Matthew David Skerrett A/c”, 17 Chrystobel Crescent, Hawthorn	100.00	''	''
Mr Michael Francis Skerrett, “William Francis Skerrett A/c”, 17 Chrystobel Crescent, Hawthorn	100.00	''	''
Mr Michael Francis Skerrett, “James Bryan Skerrett A/c”, 17 Chrystobel Crescent, Hawthorn	100.00	''	''
Mrs Julie Ann Skerrett, 17 Chrystobel Crescent, Hawthorn	968.00	''	''
Mr Michael Francis Skerrett, “Stephanie Ann Skerrett A/c”, 17 Chrystobel Crescent, Hawthorn	100.00	''	''
Terence Neil Skidmore, 10/28 Hastings St, Scarborough, WA	106.40	''	28/04/00
Terence Neil Skidmore, 10/28 Hastings St, Scarborough, WA	133.00	''	27/10/00
Russell John Skilleter & Michelle Laine Skilleter, 7 Alinda Close, Middle Dural, NSW	100.00	''	''
Mr Angelo Vince Sklavos, 1/115 New South Head Road, Vaucluse, NSW	220.00	''	''
Mr Angelo Sklavos, 17 South Avenue, Double Bay, NSW	123.45	''	28/04/00
Mr Angelo Sklavos, 17 South Avenue, Double Bay, NSW	204.00	''	27/10/00
John Skrzypek, 16 Foley Street, Padstow, NSW	100.00	''	''
Timothy Michael Slack, 23 Bellata Street, The Gap, Qld	120.70	''	28/04/00
Timothy Michael Slack, 23 Bellata Street, The Gap, Qld	200.00	''	27/10/00
Est Alexander George Dickson Slater, 2/45 Parkin Street, Rockingham, WA	100.00	''	''
Michael John Slattery, 24 Ferme Street, Port Pirie, SA	100.00	''	''
Geraldine Slattery, PO Box 731, Swan Hill	100.00	''	''
Mr Justin Robin Lewis Slaughter, 32 Susan Street, Red Hill, Qld	241.45	''	28/04/00
Mr Mathew John Slavica, Unit 3, 29 Botany Street, Randwick, NSW	1,159.70	''	27/10/00
Cheryl Anne Slawinski, 72 Bottlebrush Crescent, South Hedland, WA	160.00	''	28/04/00
Cheryl Anne Slawinski, 72 Bottlebrush Crescent, South Hedland, WA	200.00	''	27/10/00

Jasmine Maria Louisa Sliger, 5B/8 Cliff Street, Milsons Point, NSW	220.00	''	''
Hilda Marie Sloan, 11/8A Kenilworth Street, Mackay, Qld	100.00	''	''
Agnese Slobbe, PO Box 180, Kerrimuir	250.00	''	''
Neville Sloss & Rhiannon Sloss, 57 Griffell Way, Duncraig, WA	100.00	''	''
Gregory Keith Smart & Kylie Anne Smart, 101 Warburton Road, Canterbury	240.00	''	''
Wayne Edward Smeaton, 133 Pashen St, Morningside, Qld	253.00	''	''
Wayne E. Smeaton, 133 Pashen Street, Morningside, Qld	248.00	''	''
Charlotte Alyce Smiles, PO Box 71, Balgowlah, NSW	100.00	''	''
Peter Smith, 6 Montpellier Street, Neutral Bay, NSW	150.00	''	''
Pamela C. Smith, 16 Cook Street, Glebe, NSW	160.00	''	28/04/00
Gordon Russell Smith & Est Aya Smith, 7 Masthead Drive, Cleveland, Qld	160.00	''	''
Gordon Russell Smith & Est Aya Smith, 7 Masthead Drive, Cleveland, Qld	200.00	''	27/10/00
Jean Smith, "Est R Stevens Smith A/c", 2501/22 Kirkwood Road, Tweed Heads South, NSW	372.00	''	''
Lynette Jane Smith & Craig Smith & Lachlan Smith, 9 Ohara Street, Blackburn	100.00	''	''
Est Stanley Greg Smith, C/- Henry Davis York, Level 25, 135 King Street, Sydney, NSW	200.00	''	''
Estate Bessie Elizabeth Smith, 130 Dalrymple Rd, Sunbury	216.00	''	''
Francis Edward Smith & Jennifer Kay Brownlie Smith, 4 Letchworth Road, Coorparoo, Qld	120.00	''	''
Mr David Smith, 7 Mount Street, Hurlstone Park, NSW	136.00	''	28/04/00
Anthony Latham Smith & Marie Latham Smith, 1/6 Smith Street, Wollongong, NSW	140.00	''	27/10/00
Belinda Jane Smith, 309 Shakespeare Street, Mackay, Qld	120.70	''	28/04/00
Belinda Jane Smith, 309 Shakespeare Street, Mackay, Qld	200.00	''	27/10/00
Wayne Smith, 7 Lovegrove Close, Mount Claremont, WA	160.00	''	28/04/00
Wayne Smith, 7 Lovegrove Close, Mount Claremont, WA	200.00	''	27/10/00
Mr Adam Jeffrey Smith, Unit 5, 6 Corona Street, Sunshine Beach, Qld	100.00	''	''
Jeanette Margaret Smith, PO Box 783, Kyabram	100.00	''	''
Debbie Smith, PO Box 171, Erina, NSW	255.00	''	''
David Smith & Rosemary Coppen, PO Box 5055, South Lake, WA	120.00	''	''
Edward Norman Smith, 1 Chesterfield Avenue, Malvern	144.00	''	28/04/00
Mr Ronald Edward Smith, 16 Herlihys Road, Lower Templestowe	100.00	''	27/10/00
Mr Cameron Bruce Smith, 7 Winchester Avenue, Wights Mountain, Qld	100.00	''	''
Mrs Laurie Dorothea Smith, Attn: Mr B. R. Arnott-Smith, Suite 13, Level 5, 44 Bridge Street, Sydney, NSW	400.00	''	''
Mr Gary Smith, "Smith Investment A/c", GPO Box 2850AA, Melbourne	400.00	''	28/04/00
Mr Robert Michael Smith, 24 Napier Street, Bathurst, NSW	140.00	''	27/10/00
Ryan Courtney Smith, PO Box 1282, Neutral Bay, NSW	100.00	''	''
Christopher J. A. Smith, PO Box 1282, Neutral Bay, NSW	100.00	''	''
Mr Barry Smith & Mrs Bette Smith, "Super Fund A/c", 81 Wigg Street, Wodonga	260.00	''	''

Annie Smith, 13 Hurley Way, Hillarys, WA	120.00	''	28/04/00
Annie Smith, 13 Hurley Way, Hillarys, WA	150.00	''	27/10/00
Sidney Edward Smith, 24 Woodend Road, Ipswich, Qld	253.00	''	''
Elly Smith & Vanessa Smith, 27 Castleton Crescent, Gowrie, ACT	100.00	''	''
Mr Peter John Smith, Unit 3, 20 Tranmere Street, Drummoyne, NSW	100.00	''	''
Zachary Smith, 4/347 Edgecliff Road, Edgecliff, NSW	100.00	''	''
Georgina Elaine Smith, 35 Killarney Street, Mosman, NSW	100.00	''	''
Lauren Barbara Smith, 35 Killarney Street, Mosman, NSW	100.00	''	''
Ms Reta Mabel Smith, 25 Newell Way, Noranda, WA	100.00	''	''
David Curzon Smith, Locked Bag 15, Sydney, NSW	100.00	''	''
Mr D. H. Smith, 32 Emerald Way, Carine, WA	100.00	''	''
Kim A. Smith, 8 Cottonwood Court, Capalaba, Qld	250.00	''	''
Juliana D Smith, PO Box 4999, Chisholm, ACT	132.80	''	28/04/00
Troy A Smith, 24 Darren Drive, Slacks Creek, Qld	100.00	''	27/10/00
Mr Leslie Francis Bishop Smith, PO Box 291, Malvern	140.00	''	''
Mr Adrian Stanley Paul Smith & Mrs Elisa Nicole Smith, 30 Papworth Place, Meadow Heights	300.00	''	''
Gregory Colin Smith, 206 Coppin Street, Richmond	181.30	''	28/04/00
Gregory Colin Smith, 206 Coppin Street, Richmond	300.00	''	27/10/00
Marilyn Suzanne Smith, 9 Nonda Place, Parkinson, Qld	100.00	''	''
Smith & Clarke Refrigeration Pty Ltd, "Super Benefit Fund A/c", C/- PO Box 121, Oatley, NSW	127.90	''	28/04/00
Smith & Clarke Refrigeration Pty Ltd, "Super Benefit Fund A/c", C/- PO Box 121, Oatley, NSW	212.00	''	27/10/00
Audry Sophia Smits & Steven Edward Brown, 57 Maxwell Parade, Forresterville, NSW	190.00	''	''
George Smolanko & Linda Pamela Smolanko, 19 Elston Street, Brooklyn Park, SA	120.00	''	''
Suzanne Smorrook "Stephen James Shorrook A/c", 1 Whitham Place, Pearce, ACT	100.00	''	''
Mr Malcolm Wilson Snaith, 32 Wood Street, Warwick, Qld	100.00	''	''
Peter Arie Snel, PO Box 165, Katherine, NT	248.00	''	''
Mr You Thiam Sng, C/- ANZ Private Banking, Attn:Ms Shing Black, Level 6, 20 Martin Place, Sydney, NSW	500.00	''	''
Mr Greg Snowball & Mrs Dianne Snowball, 1045 Burke Road, Hawthorn East	170.00	''	''
Miss Kitwing So, 37 Argyle Street, West Footscray	100.00	''	''
Mr Robin Kenneth Sobel, 1 Boronia Rd, Bellevue Hill, NSW	106.00	''	''
Victoria Michell Soden, 52 Lukis Street, Port Hedland, WA	100.00	''	''
Sofas International Pty Ltd, PO Box 965, Bankstown, NSW	192.00	''	28/04/00
Sofas International Pty Ltd, PO Box 965, Bankstown, NSW	240.00	''	27/10/00
Richard K. Solly, 16 Ailsa Street, Ascot Vale	272.00	''	28/04/00
Daniel Solomon "Jeremy Solomon A/c", 22 Edward Street, Mittagong, NSW	100.00	''	27/10/00
Mr Aaron Solomon, 18 Kambala Road, Bellevue Hill, NSW	217.20	''	28/04/00
Mr Aaron Solomon, 18 Kambala Road, Bellevue Hill, NSW	360.00	''	27/10/00
Mr Anthony Thomas Somerville, 4/174 Coogee Bay Road, Coogee, NSW	120.70	''	28/04/00
Mr Anthony Thomas Somerville, 4/174 Coogee Bay Road, Coogee, NSW	100.00	''	27/10/00

Teon Son, 22 Hertford Crescent, Balwyn	100.00	''	''
Jin Mei Song, 2/199 Auburn Road, Yagoona, NSW	120.00	''	''
Tuck Choong Soo, PO Box 1152, Strathfield, NSW	624.00	''	28/04/00
Ranvir Sood, 10 Redesdale Rd, Ivanhoe	127.90	''	''
Sootcha No 90 Pty Ltd "Super Fund A/c" 30 Elizabeth Street, Sawtell, NSW	270.00	''	27/10/00
John Sorokoput, PO Box 1028, Lightning Ridge, NSW	164.00	''	28/04/00
Mr Peter Soschinski, C/ Expo Technik Aust P/L, 5 Tullamarine Park Road, Tullamarine	200.00	''	27/10/00
South Pacific Harvest Pty Ltd, "Super Fund A/c", PO Box 4, Burwood	260.00	''	28/04/00
South Pacific Harvest Pty Ltd, "Super Fund A/c", PO Box 4, Burwood	325.00	''	27/10/00
Southern Cross Automation Pty Ltd, PO Box 105, Arncliffe, NSW	100.00	''	''
Southern Cross Sport Management Limited, C/- Hollis & Co Reid Hall, 3 Reid Street, Hamilton Hmii, Bermuda	8,380.00	''	''
Marlene Rose Spaccavento, 276 Old Canterbury Stree, Summer Hill, NSW	160.00	''	''
Damien Spain, 20 Ferrier Street, Mount Macedon	100.00	''	''
Sparke Pastoral Company Pty Ltd, "Sparke Super Fund A/c", PO Box 282, Spring Hill, Qld	120.70	''	28/04/00
Helen Ann Sparrow, 8 Warwick Close, Blaxland East, NSW	100.00	''	27/10/00
Robert Norman Spears & Li Xin Zheng, 64 David Avenue, North Ryde, NSW	250.00	''	''
Mr Robert N. Spears, 64 David Avenue, North Ryde, NSW	690.00	''	''
Spectrum Dental Ceramics Lab Pty Ltd, Level 4 126 Russell Street, Melbourne	1,600.00	''	''
Speer Investments Pty Ltd, 54 Flurizel Street, Glen Iris	100.00	''	''
Ian Spence, Rear of Constitution, 14 Hill Road, Sorrento	108.00	''	''
Julie Spencer, PO Box 541, Curtain, ACT	120.70	''	28/04/00
Mr Wayne Spencer, Unit 3, 128 Hampden Road, Abbotsford, NSW	100.00	''	27/10/00
Sue Spicer, 385 Swan Street, Richmond	164.25	''	28/04/00
Sue Spicer, 385 Swan Street, Richmond	272.00	''	27/10/00
Sophia Spiliotopoulos, 52 Russell Street, Greenacre, NSW	120.00	''	''
Mr Peter Spinnler, 7 Addington Street, Morley, WA	108.60	''	28/04/00
Mr Peter Spinnler, 7 Addington Street, Morley, WA	500.00	''	27/10/00
Giuseppe Spirito, 6 Somerset Rise, Kardinya, WA	160.00	''	28/04/00
Giuseppe Spirito, 6 Somerset Rise, Kardinya, WA	200.00	''	27/10/00
Patricia Maria Spithill, 36 Bedford Rd, North Epping, NSW	210.00	''	''
Leo Spivak, 4 Albemarle Avenue, Rose Bay, NSW	200.00	''	''
Sportsmart Investments P/L, 83 Cochranes Rd, Moorabbin	408.00	''	28/04/00
Racehorse Sportsmedicine, 2113 Coimadai Rd, Toolern Vale	140.00	''	27/10/00
Glenn Philip Spotswood, 77 Wimbledon Avenue, North Narrabeen, NSW	127.90	''	28/04/00
Glenn Philip Spotswood, 77 Wimbledon Avenue, North Narrabeen, NSW	212.00	''	27/10/00
Rodney Andrew John Sprenger, 7 Amsterdam St, Wishart, Qld	100.00	''	''
Mr Cornelius Albertus Sprengers, PO Box 11-483, Manners Street, Wellington 6034, New Zealand	1,551.91	''	28/04/00
Mr Mark Geoffrey Spring, 9 Adam Drive, 289969 Singapore	115.00	''	27/10/00

Damien John Sproule, 3 Dale Close, Traralgon	120.70	''	28/04/00
Gwendoline Mary Matilda Sproule, 20–22 Annangrove Road, Kenthurst, NSW	646.24	''	''
Spundran Pty Ltd, 52 Cliff Avenue, Northbridge, NSW	111.40	''	27/10/00
Graham Charles Spurgeon & Elizabeth Grace Spurgeon, 11 Kanowna Rd, Largs Bay, SA	120.00	''	''
Raghu Sreenivafsan & Rukumani Raghu, 10 Carner Court, Parkwood, Qld	120.70	''	28/04/00
Raghu Sreenivafsan & Rukumani Raghu, 10 Carner Court, Parkwood, Qld	200.00	''	27/10/00
Kamnoon Srethbhakdi, 34 Emerstan Drive, Castle Cove, NSW	270.00	''	''
Felie Staas, PO Box 97, Matraville, NSW	100.00	''	''
David Staas, PO Box 97, Matraville, NSW	100.00	''	''
Susan Kay Stack & Jeffrey Lee, 105 Penson Street, Stretton, Qld	100.00	''	''
Peter Maurice Donald Stafferto, 589A Nepean Highway, Bonbeach	150.00	''	''
Stafford Whelan Pty Ltd, 278 Union Road, Moonee Ponds	120.00	''	''
Mr John Stagoll, 165 Belconnen Way, Hawker, ACT	120.00	''	''
Samuel Trevean Standfield, PO Box 5048, Wonga Park	120.00	''	''
Timothy A. Stanes, PO Box 120, Beaconsfield	151.00	''	28/04/00
Timothy A. Stanes, PO Box 120, Beaconsfield	250.00	''	27/10/00
Stanistreet Nominees Pty Ltd, "Stanistreet Super/Fund A/c", Suite 2, 83 Hartnett Drive, Seaford	100.00	''	''
Stanlea Pty Ltd, 5A Yarradale Road, Toorak	100.00	''	''
Elizabeth May Stanley, "Nicholas Luke Stanley A/c", 285 Rockonia Road, North Rockhampton, Qld	100.00	''	''
Florence Frances Stanton, Warrunmda Village, 8 Gardeners Walk, Kyabram	100.00	''	''
Patricia Margaret Stapleton, 9 Rotoroa Court, Taylors Lakes	100.00	''	''
Lawrence Frederick Stapleton, 9 Rotoroa Court, Taylors Lakes	140.00	''	''
Starcom Australia Pty Ltd, 44 Somes Street, Wantirna South	301.55	''	28/04/00
Mr Christopher Damien Starrs, 88 Burbridge Rd, Hilton, SA	100.00	''	27/10/00
Jennifer Lee Stauber, 68 Fowler Road, Illawong, NSW	252.00	''	''
Edward Stauber, 68 Fowler Road, Illawong, NSW	252.00	''	''
Mary Frances Staunton, PO Box 281, Ingle Farm, SA	160.00	''	''
Mary Frances Staunton & Jeffrey John Kasparian, PO Box 281, Ingle Farm, SA	160.00	''	''
Stavrem Project Management Pty Ltd, "Stavrem Proj Mngmt S/F A/c", C/- FPD P/L, 78 Currie Street, Adelaide, SA	120.00	''	''
Anthony Stavrinis, 55 Binalong Avenue, Allambie, NSW	100.00	''	''
Anne Stbarbe, 59 Beaconsfield Road, Chatswood, NSW	108.60	''	28/04/00
John Alan Stead & Margaret Mary Stead, 20 Ullapool Road, Mt Pleasant, WA	100.00	''	27/10/00
Mrs Betty Christine Steele & Mr James William Fitzwalter Thomson, PO Box 18024, Collins Street East, Melbourne	1,100.00	''	''
Peter Steenson, 3 Surrey Street, Stanmore, NSW	100.00	''	''
Michelle Anne Steinepreis, 50 Eric Street, Como, WA	320.00	''	28/04/00
Michelle Anne Steinepreis, 50 Eric Street, Como, WA	400.00	''	27/10/00

Helmut Steininger & Liliana Lucchesi & Andrew Lucchesi, 27 Frogmal Drive, Noble Park	100.00	''	''
Elisavet Stepanian, 18 Exeter Grove, Kings Langley, NSW	372.00	''	''
Stephen Murphy Pty Ltd, 1 La Scala Court, Isle of Capri, Qld	100.00	''	''
Anthony Howard Stephens, 10 Rylston Court, Mount Eliza	140.00	''	''
Natalie Irene Stephens, 10 Rylston Court, Mount Eliza	100.00	''	''
Benjamin David Stephens, 39 Ramsdale Street, Doubleview, WA	120.00	''	''
Tony Stephens, 41 New Street, Frankston	100.00	''	''
Rhonda Stephens, PO Box 1, Kunyung	100.00	''	''
Melissa Stephens, PO Box 1, Kunyung	100.00	''	''
Anthony Stephens, PO Box 1, Kunyung	140.00	''	''
Graham Howe Stephens, 34 Wandana Drive, Wandana Heights	120.00	''	''
Graeme Anders Stephensen, PO Box 899, Ashfield, NSW	200.00	''	''
Graeme Stephensen, "Stephensen Family S/F A/c", PO Box 899, Ashfield, NSW	528.00	''	''
Steve Wignall Computer Services Pty Ltd, "Steve Wignall S/Fund A/c", 3/22 Carabella Street, Kirribilli, NSW	128.00	''	''
Est Dorothy May Stewart & Ricky Lenzi, "N. Burchill & Co A/c", PO Box 5051, Mordialloc	100.00	''	''
David Benjamin Stewart, 97 Dundilla Road, Frenchs Forest, NSW	100.00	''	''
Laurence Francis Stewart, QCL House, Level 3 40 Mcdougall, Milton, Qld	100.00	''	''
Matthew Stewart, 21 The Esplanade, Frenchs Forest, NSW	160.00	''	28/04/00
Vaughan Andrew Stibbard, 32 Woodbury Rd, St Ives, NSW	120.70	''	''
Sean Markel Stidwell, PO Box 1010, Albany, WA	100.00	''	27/10/00
Ben Still, 3A/44 Reservoir Street, Surry Hills, NSW	120.00	''	''
Jason Stirling, 32 York Street, Prahran	150.00	''	''
Mr Robert James Stock, 60 Ruskin Street, Elwood	200.00	''	''
Vesna Stojanovska "DJ & JR Stojanovska A/c", 14 Fairbridge Crescent, Ainslie, ACT	100.00	''	''
Est Trajan Stojanovski, 16 College Crescent, Keysborough	151.00	''	''
George Stojavljevic, Aubreen Street, Collaroy Plateau, NSW	120.70	''	28/04/00
George Stojavljevic, Aubreen Street, Collaroy Plateau, NSW	200.00	''	27/10/00
Alan Nicholas Stokes, 70 York Street, Caulfield	192.95	''	28/04/00
Mr Andrew Pattison Stone, St Pauls College, University of Sydney, 9 City Road, Camperdown, NSW	150.00	''	27/10/00
Stonelen Pty Ltd, C/- M Fitzgerald Twinelles, Illawarra Highway, Moss Vale, NSW	100.00	''	''
Douglas Armstrong Stoney, "Mount Barker Meats S/F A/c", PO Box 45, MacDonald Avenue, Mount Barker, WA	244.00	''	''
Stoney Hill Australia Pty Ltd, "Dove Rocks Super Fund A/c", 20 Jackson Street, Balgowlah, NSW	301.55	''	28/04/00
Peter John Stoops, 2 Fenton Crescent, Frankston	200.00	''	27/10/00
Jodie Lea Storno, 8 Jacka Street, Essendon	100.00	''	''
John W. Stow, 13 Kinsellas Drive, Lane Cove, NSW	300.00	''	''
Est Cheryl Marjorie Straede, PO Box 384, Epping, NSW	150.00	''	''
Michael A. Strand, PO Box 269, Tennant Creek, NT	200.00	''	28/04/00
David Strangward & Kathy McBrien, 2/26 The Crescent, Manly, NSW	100.00	''	27/10/00

Strata Title Management & Realty (Tweed Heads) Pty Ltd, PO Box 134, Tweed Heads, NSW	112.00	''	28/04/00
Strati Investment Pty Ltd, C/- Mr Tony Strati, 13/215 Kenyon Street, Fairfield, NSW	100.00	''	27/10/00
Est Miss Carole Strauss, C/-SLC Investment Services, Pty Ltd, PO Box 286, Deepdene DC, Balwyn	424.00	''	28/04/00
Mr Simon Frederick Stretton, PO Box 336, North Adelaide, SA	120.00	''	27/10/00
Mr John Raymond Stretton, LBA 852, Locked Bag 25, Gosford, NSW	100.00	''	''
Mr Nicholas James Stronell, 39 Eastwood Street, Kensington	151.00	''	28/04/00
John Edward Strudwick, Shop 19, Imperial Cnt, Mann Street, Gosford, NSW	100.00	''	27/10/00
Stuart Murphy Industries Pty Ltd, "S. M. Industries A/c", Level 1, Fox Studios, Driver Avenue, Moore Park, NSW	100.00	''	''
Andrew Stunell, 3 Alfred Road, West Croydon, SA	100.00	''	''
Ms Meng Ying Su, 27 Hamish Street, Calamvale, Qld	295.60	''	28/04/00
Monty Clarke Suffern, PO Box 502, Heathmont	100.00	''	27/10/00
Premila Sukul, 66 Middlehope St, Bonnyrigg Heights, NSW	100.00	''	''
Rohan Sullivan, 7/11 Springfield Avenue, Potts Point, NSW	120.00	''	''
Matthew Sullivan, 3 Malvern Cres, Strathfield, NSW	100.00	''	''
Judith Anne Sullivan, 3 Minnamurra Rd, Northbridge, NSW	130.90	''	28/04/00
Judith Anne Sullivan, 3 Minnamurra Rd, Northbridge, NSW	217.00	''	27/10/00
Lisa Gaye Sullivan, 1008/168 Kent Street, Sydney, NSW	100.00	''	''
Mr John Sullivan, 69 Lilly Street, Sherwood, Qld	120.70	''	28/04/00
Mrs Karren Louise Sullivan, PO Box 2361, Chermide, Qld	100.00	''	27/10/00
Stephen Chong Sun, 42 Fishburn Crescent, Castle Hill, NSW	112.00	''	28/04/00
Stephen Chong Sun, 42 Fishburn Crescent, Castle Hill, NSW	140.00	''	27/10/00
Mr Pao-Tien Sun & Mrs Chin-Hsia Sun Lu, 9 Woodgrove Place, Sunnybank Hills, Qld	422.25	''	28/04/00
Sunbridge Holdings Pty Ltd, Lot 4, Shreeve Road, Canning Vale, WA	110.00	''	27/10/00
Sunny Investments Pty Ltd, "Superannuation Fund A/c", 146 Collins Street, St Ives, NSW	100.00	''	''
Supa Stik Labels & Labelling Systems Pty Ltd, "Holywell S/F A/c", 42 Oban Road, City Beach, WA	100.00	''	''
Superfos Pty Ltd, "P Beerens Fund A/c", 11/459 Little Collins Street, Melbourne	200.00	''	''
Vincenzo Suppa, 21 Oswell Street, Rockdale, NSW	100.00	''	''
Muthupandi Suppiah & Vija Suppiah, 7/32 Alice Street, Harris Park, NSW	100.00	''	''
Ms Lyndell Supple, 9/166 Victoria Street, Brunswick	110.00	''	''
Mr Frank Surgener, 10 Amherst Street, Fremantle, WA	200.00	''	''
Ms Fiona Jane Surtees, 10 Robinson Street, Subiaco, WA	152.00	''	28/04/00
Susan M. Messner Pty Ltd, "Super Fund A/c", 247 Annandale Street, Annandale, NSW	144.00	''	''
Susan M Messner Pty Ltd "Super Fund A/c", 247 Annandale Street, Annandale, NSW	180.00	''	27/10/00
Philip Sutherland, 508A George Street, Windsor South, NSW	100.00	''	''
Lesa Sutherland & South Windsor Medical Centre, PO Box 634, Windsor South, NSW	100.00	''	''

John Finlay Sutherland & Alexandra Gaye Sutherland, PO Box 497, Kingston, Tas.	100.00	''	''
Mr Philip Francis Sutherland, Level 3, 3/169 Phillip Street, Sydney, NSW	112.00	''	28/04/00
Mr David Sutherland, "Thomas Sutherland A/c", 22 Lord Street, Roseville, NSW	181.30	''	''
Mr David Sutherland, "Thomas Sutherland A/c", 22 Lord Street, Roseville, NSW	300.00	''	27/10/00
Mr David Sutherland, "Rachel Sutherland A/c", 22 Lord Street, Roseville, NSW	181.30	''	28/04/00
Mr David Sutherland, "Rachel Sutherland A/c", 22 Lord Street, Roseville, NSW	300.00	''	27/10/00
Daniel John Sutherland, PO Box 51W, Ballarat	100.00	''	''
Sutherland Family Super Fund Pty Ltd, 217 Tufnell Road, Banyo, Qld	180.00	''	''
Stephen Anthony Sutrin, "Project Plaster A/c", 93 Lemon Tree Passage R, Salt Ash, NSW	100.00	''	''
Anita Jane Sutton, 112 Seaforth Crescent, Seaforth, NSW	120.70	''	28/04/00
Cherry Alison Sutton, 23 Rowes Road, Werribee	100.00	''	27/10/00
Mr Trevor L. Sutton, PO Box 223, Bond University, Qld	200.00	''	28/04/00
SVB Enterprises Pty Ltd, 41 Stanley Street, Burwood, NSW	150.00	''	27/10/00
Mr Andrew Peter Swain, 26 Elliott Road, Trigg, WA	181.30	''	28/04/00
Josephine Anne Swan, PO Box 8669, Alice Springs, NT	120.70	''	''
Philip Swann, 2113 Coimadai Road, Toolern Vale	112.00	''	''
Philip Swann, 2113 Coimadai Road, Toolern Vale	140.00	''	27/10/00
Philip David Swann, 15 Linum Street, Blackburn	112.00	''	28/04/00
Philip David Swann, 15 Linum Street, Blackburn	140.00	''	27/10/00
Philip Swann, Racehorse Sports Medicine A/c, 15 Linum Street, Blackburn	140.00	''	''
Vincent Peter Swarbrick & Terisa Swarbrick, "The Swarbrick Super A/c", 7 Chenin Lane, The Vines, WA	314.00	''	''
Edmund James Sweeney & Louise Mary Nash, 17 Mort Street, Balmain, NSW	160.00	''	''
Swen Pty Ltd, 115 Kissing Point Road, Turrumurra, NSW	125.65	''	28/04/00
Swirg Trading Pty Ltd, "G. & M. L. Ford Super Fund A/c", PO Box 7339, Cloister Square, WA	183.55	''	''
Swirg Trading Pty Ltd "G. & M. L. Ford Super Fund A/c", PO Box 7339, Cloister Square, WA	304.00	''	27/10/00
John Ernest Sykes, 53 Tulloh Street, Willoughby, NSW	176.00	''	28/04/00
John Ernest Sykes, 53 Tulloh Street, Willoughby, NSW	220.00	''	27/10/00
Jason Roderick Symes, 91 Arden Street, Clovelly, NSW	100.00	''	''
Mr Andrew John Symms, 2 Woodlands Drive, Skipton, North Yorkshire BD23 1QU, United Kingdom	100.00	''	''
Mrs Anne Symons, 36 Daisy Street, Essendon	100.00	''	''
Todd Ken Symons, 36 Daisy Street, Essendon	100.00	''	''
Russell Stephen Symons, 36 Daisy Street, Essendon	100.00	''	''
Robert Symons, 36 Daisy Street, Essendon	100.00	''	''
Matt Symons, 36 Daisy Street, Essendon	100.00	''	''
Kate Symons, 36 Daisy Street, Essendon	100.00	''	''
Jayde Symons, 36 Daisy Street, Essendon	100.00	''	''
Mrs Anne Symons, 36 Daisy Street, Essendon	100.00	''	''
Richard Symons, 36 Daisy Street, Essendon	100.00	''	''
Ross Symons, 36 Daisy Street, Essendon	100.00	''	''

Russell Symons, 36 Daisy Street, Essendon	100.00	''	''
Syndicate Holdings Pty Ltd, 21 Devon St, Goodwood, SA	100.00	''	''
J. C. K. Advanced Systems, 20 Daw St, Merrylands, NSW	208.00	''	28/04/00
J. C. K. Advanced Systems, 20 Daw St, Merrylands, NSW	260.00	''	27/10/00
Mimar Computer Systems, 4/145 Marion St, Fremantle, WA	100.00	''	''
Zoltan Frank Szabo, 11 Saunders Street, Westall	100.00	''	''
Ms Andrea Eva Szamek, 23 Suttie Road, Double Bay, NSW	391.95	''	28/04/00
T M Industries Super Fund & Tony McDonell, 6 Fraser Street, Homebush West, NSW	126.75	''	''
T M Industries Super Fund & Tony McDonell, 6 Fraser Street, Homebush West, NSW	210.00	''	27/10/00
T. P. Murphy Melb Pty Ltd, "Super Fund A/c", PO Box 290, Hawthorn	240.00	''	''
T. P. Murphy Melb Pty Ltd, "Super Fund Account", PO Box 290, Hawthorn	160.00	''	''
Daria Bahareh Taban, 126 Heaslip St, Mangerton, NSW	100.00	''	''
Ms Louise Taechaubol, Level 15, 72 Castlereagh Street, Sydney, NSW	100.00	''	''
Estate Margaret Mary Taggart, C/- Millennium Law, 1st Floor, 140 Wakefield Street, Adelaide, SA	100.00	''	''
Mr Behnam Tai & Mrs Marian Tai, 206 Narra Valley Drive, Niagara Park, NSW	211.50	''	''
Tait Strategies Pty Ltd, C/- Edward Charles R/E, PO Box 680, Willoughby, NSW	100.00	''	''
Mr Ryoji Takahashi, 11/21-25 Elizabeth St, Allawah, NSW	100.00	''	''
Mr Larry Takis, "Takis Family Super Fund A/c", 1 Addison Street, Elwood	150.00	''	''
Carol Beveridge Talbot & Trevor McDonald Croucher, 47 Recreation Parade, Semaphore Park, SA	100.00	''	''
Shane Philip Talbot & Lizette Christina May Talbot, 34 Michael Holt Crescent, Gordon, ACT	140.00	''	''
Kwok Keung Tam, 62 Highgate Street, Strathfield, NSW	120.70	''	28/04/00
Oijam Tam, Rachel & Caroline Cham A/c, 5/74 Obron Street, Coogee, NSW	100.00	''	27/10/00
William Kowk Hung Tam, 62 Highgate St, Strathfield, NSW	176.00	''	28/04/00
Theodore John Tambakis, 1/71 Evans Street, Harbord, NSW	260.00	''	27/10/00
Tameshore Pty Ltd, "Stevens Family Ac", 29 Lawson Street, Balmain, NSW	100.00	''	''
Choon Yeong Tan, 63/333 Bulwara Road, Ultimo, NSW	160.00	''	28/04/00
Choon Yeong Tan, 63/333 Bulwara Road, Ultimo, NSW	200.00	''	27/10/00
Sandra Tan, 3 Bindaring Parade, Claremont, WA	100.00	''	''
Mrs Xiu Ming Tan, PO Box 168, Strathfield, NSW	165.00	''	''
M Tan, L/321 Kent Street, Sydney, NSW	120.00	''	''
Soh Wen Tan, 30 Walter Street, Williamstown	100.00	''	''
Queenie Chui Kuin Tan, 704 Station Street, Box Hill	150.00	''	''
Terence Chun Kiat Tan, 80 Belford Road, East Kew	211.15	''	28/04/00
Terence Chun Kiat Tan, 80 Belford Road, East Kew	350.00	''	27/10/00
Kim Seong Tan, PO Box 347, Chatswood, NSW	241.45	''	28/04/00
Kim Seong Tan, PO Box 347, Chatswood, NSW	400.00	''	27/10/00
Bwee Hwa Tan, 31 Derriwong Road, Dural, NSW	128.00	''	''
Chwee Lee Tan, 3 Bindaring Parade, Claremont, WA	1,085.45	''	28/04/00
Chwee Lee Tan, 3 Bindaring Parade, Claremont, WA	1,800.00	''	27/10/00
Arthur Tan, 18/644 Chapel Street, South Yarra	1,603.70	''	28/04/00

Arthur Tan, 18/644 Chapel Street, South Yarra	2,660.00	''	27/10/00
Mrs Yien Chuen Tan, 42 Williams Road, Nedlands, WA	280.00	''	28/04/00
Mrs Yien Chuen Tan, 42 Williams Road, Nedlands, WA	350.00	''	27/10/00
Dr Amgad Tanaghow, 14 Alex Avenue, Wheelers Hill	100.00	''	''
Stewart Kam Tang, PO Box 335, Bulleen	120.70	''	28/04/00
Stewart Kam Tang, PO Box 335, Bulleen	200.00	''	27/10/00
Laurence Fook Leong Tang, PO Box 1640, Chatswood, NSW	212.00	''	''
Wei Zhong Tang, 4 Vesta Place, Gilmore, ACT	120.70	''	28/04/00
Wei Zhong Tang, 4 Vesta Place, Gilmore, ACT	200.00	''	27/10/00
Mr John Joseph Tanna, "Loretta Kathleen Tanna A/c", 401 Beamish Street, Campsie, NSW	100.00	''	''
Mr John Joseph Tanna, "Andrew Velion Tanna A/c", 401 beamish Street, Campsie, NSW	100.00	''	''
Helen Tannous, 121 Waiora Rd, Heidelberg Heights	204.00	''	28/04/00
Helen Tannous, 121 Waiora Rd, Heidelberg Heights	255.00	''	27/10/00
Mr Kyriakos Tanos, 162 Alice Street, Newtown, NSW	180.00	''	''
Lorraine Tarabay, 43 Hocking Avenue, Earlwood, NSW	210.00	''	''
Tarantelle Pty Ltd, 10 Brownell Road, Glen Iris	120.70	''	28/04/00
Tarantelle Pty Ltd, 10 Brownell Road, Glen Iris	200.00	''	27/10/00
Lewis John Targett & Jennie Louise Ponsford, 60 Chatsworth Road, Prahan	104.00	''	''
Rhonda Tartaglia & Michael Tartaglia, 83 Forest Road, Miranda, NSW	100.00	''	''
Donald Bruce Tasker, 14 Grandview Grove, Toorak Gardens, SA	150.00	''	''
Tasrave Pty Ltd, 10 Casula Road, Casula, NSW	120.00	''	''
Bruno Tassone & Lily Tassone, 45 Pinetree Crescent, Lalor	150.00	''	''
Tathatoo Pty Ltd, PO Box 432, Narooma, NSW	112.00	''	28/04/00
Mr John Tatoulis, 278 Gore Street, Fitzroy	141.42	''	''
Kate Tavan, 9 Nash Street, Northcote	120.00	''	27/10/00
Mrs Parish Tavkoli-Siahkali, 37 Percival St, Lilyfield, NSW	100.00	''	''
Taxis Combined Services Pty Ltd, 357 Glenmore Road, Paddington, NSW	260.00	''	''
Dr Ava Tay, Dr L. Choon Leong Spec Surgical, Air Keoh Medical Centre, 2418KM8 Lebu Air Keroh, 75450 Melaka	100.00	''	''
Philip Vere Taylor, 2/234 Pacific Highway, Artarmon, NSW	100.00	''	''
Annamaria Taylor & William John Taylor, 10 Hermes Street, Moorooka, Qld	150.00	''	''
Estate Ruth Margaret Taylor, 8 Braunton Street, Bicton, WA	100.00	''	''
David Geoffrey Taylor, PO Box 148, Newman, WA	100.00	''	''
David Michael Taylor & Roma Taylor, 7 Casey Drive, Berwick	181.30	''	28/04/00
Jim Taylor, 21 Tilanbi Close, Terrigal, NSW	200.00	''	27/10/00
Judy Taylor, 11/196 Forbes Street, Darlinghurst, NSW	204.00	''	''
Heather Anne Taylor, 21 Hendy Avenue, Collaroy, NSW	100.00	''	''
Geoffrey Bruce Taylor, 21 Hendy Avenue, Collaroy, NSW	100.00	''	''
Geoffery Bruce Taylor, "Scott Sophie Luke Taylor A/c", 21 Hendy Avenue, Collaroy, NSW	100.00	''	''
Luke James Taylor, 30 Greenlands Ave, Peakhurst, NSW	100.00	''	''
David Taylor, "D. T. R. T. Superfund A/c", 7 Casey Drive, Berwick	185.75	''	28/04/00

David Taylor, "D. T. R. T. Superfund A/c", 7 Casey Drive, Berwick	308.00	"	27/10/00
Patrick Taylor, PO Box 472, Spring Hill, Qld	160.00	"	"
P. V. Taylor & L. J. Taylor, "Philip Taylor S/F A/c", PO Box 896, Lane Cove, NSW	100.00	"	"
Mason Taylor, 6 Tennison Road, Concord, NSW	100.00	"	"
Mr David Gerald Taylor, 48 Woolwich Street, West Leederville, WA	217.20	"	28/04/00
Mr David Gerald Taylor, 48 Woolwich Street, West Leederville, WA	360.00	"	27/10/00
Leslie S. Taylor, 9 Point Road, Northwood, NSW	160.00	"	28/04/00
Leslie S. Taylor, 9 Point Road, Northwood, NSW	200.00	"	27/10/00
Viive Carol Taylor, 88 Cliff Avenue, Northbridge, NSW	256.00	"	28/04/00
Stephen John Taylor, "Campbell Taylor S/F A/c", 45 Holden Street, North Fitzroy	113.55	"	"
Stephen John Taylor, "Campbell Taylor S/F A/c", 45 Holden Street, North Fitzroy	188.00	"	27/10/00
Stephen John Taylor, "James Taylor A/c", 45 Holden Street, North Fitzroy	100.00	"	"
Stephen John Taylor, 45 Holden Street, North Fitzroy	128.00	"	"
Stephen John Taylor, "Isabel Taylor A/c", 45 Holden Street, North Fitzroy	100.00	"	"
Daniel Taylor, PO Box 316, Randwick, NSW	151.00	"	28/04/00
Daniel Taylor, PO Box 316, Randwick, NSW	250.00	"	27/10/00
Trevor Lane Teale, 12 Longbourne Avenue, Notting Hill	202.85	"	28/04/00
Trevor Lane Teale, 12 Longbourne Avenue, Notting Hill	336.00	"	27/10/00
Mr Warren John Tease, C/- Favero Scahill, PO Box 6060, PBC, Parramatta, NSW	110.00	"	"
Techsoft Pty Ltd, "Techsoft P/L Exec S/F A/c", PO Box 866, Glen Waverley	168.00	"	"
Tedmel Investments Pty Ltd, 186 Railway Parade, Kogarah, NSW	297.60	"	28/04/00
Tedmel Investments Pty Ltd, 186 Railway Parade, Kogarah, NSW	372.00	"	27/10/00
Miss Jane Teh, GPO Box 2794, Sydney, NSW	100.00	"	"
Ms Melinda Teh-Seit & Mr Andrew Kin Hing Seit, PO Box 698, Chatswood, NSW	130.00	"	"
Telbon Pty Ltd, "Peter Noblet Super Fund A/c", 32A Kensington Road, Rose Park, SA	320.00	"	28/04/00
Telecard Promotions Pty Ltd, Unit 4, 53 Sunbeam Street, Fairfield, Qld	100.00	"	27/10/00
Anna Merren Telford, 202 Barkly Street, St Kilda	192.00	"	28/04/00
Fiona Telford, 202 Barkley Street, St Kilda	160.00	"	"
Fiona Telford, 202 Barkley Street, St Kilda	200.00	"	27/10/00
Clinton A. Telford, 20/70 Beach Road, Mentone	675.00	"	"
Brian Francis Tellefson & Pamela Anne Tellefson, 67 Bridge Mall, Ballarat	150.00	"	"
Diana Temby, 3/174 Phillip Street, Sydney, NSW	100.00	"	"
Mr Ian Douglas Temby, 81 Kensington Road, Summer Hill, NSW	400.00	"	"
Ms Abigail Temby, C/- 81 Kensington Road, Summer Hill, NSW	200.00	"	"
Edward Tenaglia, 1 Matthau Place, McDowall, Qld	100.00	"	"

Sandra Jean Tenardi & Bradley Craig Tenardi, PO Box 318, Kwinana, WA	104.00	''	28/04/00
Corinne Teng, 3/92 Brougham Street, Kew	100.78	''	''
Corinne Teng, 3/92 Brougham Street, Kew	166.60	''	27/10/00
Mr Tony Sin Pyng Teng, 156 Eastern Ave, Kingsford, NSW	181.30	''	28/04/00
Mr Tony Sin Pyng Teng, 156 Eastern Ave, Kingsford, NSW	300.00	''	27/10/00
Beng Suan Teoh, 23 Sharon Street, Doncaster	100.00	''	''
Siang H. Teoh, 44 Belinda Crescent, Doncaster East	252.80	''	28/04/00
Tercus Pty Ltd, "Panaccio Super Fund A/c", 47 Hawthorn Grove, Hawthorn	160.00	''	27/10/00
Rosemary Terranova, PO Box 2020, Albert Park	120.00	''	''
Miss Gloria Ters, 11 Livingston Street, Burwood, NSW	100.00	''	''
Tess Corporation Pty Ltd, 30 Bates Way, Warnbro, WA	181.30	''	28/04/00
Mrs Natalie Tessmann-Keys & Mr David Tessmann-Keys, 29 Ewer Street, Carindale, Qld	200.00	''	27/10/00
Tessuor Pty Ltd, 24 Simpson Street, Applecross, WA	100.00	''	''
Tetch Pty, ACN 005261 "J Connell Family A/c", C/ John Leonard Connell, 163/461 St Kilda Rd, Melbourne	300.00	''	''
Albert Jozef Tewierik, 1320 Cape Otway Road, Modewarre	120.70	''	28/04/00
Jayesh Vasanji Thakkar, 326 Waterloo Rd, Greenacre, NSW	140.00	''	27/10/00
Jayesh Uasanji Thakkar, "Angeli Thakkar Account", 326 Waterloo Road, Greenacre, NSW	140.00	''	''
Jayesh Uasanji Thakkar, "Kiran Thakkar Account", 326 Waterloo Road, Greenacre, NSW	140.00	''	''
J. Thambirajah, 3 Tilton Terrace, City Beach, WA	100.00	''	''
Kaythi Myo Than, 18 Gibbs Street, Croydon, NSW	100.00	''	''
The Grand Tourer Superannuation Fund, 5 Cross Street, Glebe, NSW	360.00	''	''
The Law Foundation of South Australia Incorporated, Attn Mr David Milne, GPO Box 2066, Adelaide, SA	457.60	''	28/04/00
The Law Foundation of South Australia Incorporated, Attn Mr David Milne, GPO Box 2066, Adelaide, SA	572.00	''	27/10/00
The Mall Smash Repairs Pty Ltd, "A. & K. Super Fund A/c", 2 Dale Street, Brookvale, NSW	200.00	''	''
The McGlade Superannuation Fund, 15 Moama Road, East Malvern	104.00	''	''
The Osprey Trust, PO Box 1282, Neutral Bay, NSW	150.00	''	''
The Public Trustee, "Darren Arthur McKenna A/c", Box 7 GPO, Sydney, NSW	104.00	''	''
The Thinking Printing Company Pty Ltd, "Super Fund A/c", 607/180 Ocean Street, Edgecliff, NSW	292.00	''	''
Andrea Theocharous & Maria Theocharous, 88 Morgan Street, Kingsgrove, NSW	100.00	''	''
Spiros Theophilas, 82 St Marks Road, Randwick, NSW	120.70	''	28/04/00
Think Product Design Pty Ltd, 1 Caledonia Street, Paddington, NSW	100.00	''	27/10/00
Mark Damian Thomas, 10 Wolai Avenue, South Oakleigh	150.00	''	''
Evan Neil Thomas & Joy Elizabeth Scully, 128 Outhwaite Road, West Heidelberg	100.00	''	''
Estate James Leslie Thomas, C/- Robert Crane, PO Box 134, Mount Lawley, WA	240.00	''	''
Lloyd John Thomas, "Raemill P/L Super Fund A/c", 236 Hedges Avenue, Mermaid Beach, Qld	100.00	''	''

Bethmary Agnes Thomas, 4/22 Alfred Street, Kew	108.60	''	28/04/00
Bethmary Agnes Thomas, 4/22 Alfred Street, Kew	180.00	''	27/10/00
Est Ronald Vivian Thomasson, 6 Shumack Drive, Maryborough, Qld	200.00	''	''
Kathryn Lisa Thompson, 28 MacDonald Street, Erskineville, NSW	100.00	''	''
Andrew Thompson, PO Box 608, Civic Square, ACT	160.00	''	''
Bernadette M. Thompson, 44 Dunstan Street, Preston West	105.00	''	''
Mrs Valerie Joy Thompson, 15 Dennis Avenue, Keilor East	133.02	''	28/04/00
Garry Thomsen, 5 Wenke Court, East Doncaster	100.00	''	27/10/00
Mrs Margaret Thomson, 23 Clifford Street, Warragul	120.70	''	28/04/00
Mr Peter James Thomson & Mrs Nadya Pearl Thomson, 162 Tranquil Drive, Neerabup, WA	128.00	''	''
John Thorburn, 13 Counsel Road, Collbellup, WA	302.00	''	27/10/00
Thordene Pty Ltd, "Slater Boulter Pen Fund A/c", 48 Fullerton Street, Stockton, NSW	260.00	''	''
Simon Thorley, 41 Croston Road, Engadine, NSW	120.70	''	28/04/00
Simon Thorley, 41 Croston Road, Engadine, NSW	200.00	''	27/10/00
Mrs Kathleen Gertrude Thorn, 6 Lewis Spencer Place, Croydon	120.70	''	28/04/00
Mrs Kathleen Gertrude Thorn, 6 Lewis Spencer Place, Croydon	200.00	''	27/10/00
Martin G. Thorn, 32 Dress Circle Road, Avalon, NSW	160.00	''	28/04/00
Martin G. Thorn, 32 Dress Circle Road, Avalon, NSW	220.00	''	27/10/00
Mr Aaron John Thornely & Mrs Fiona Dale Thornely, 2/3 Elabana Crescent, Castle Hill, NSW	100.00	''	''
Mr Aaron John Thornely, 2/3 Elabana Crescent, Castle Hill, NSW	100.00	''	''
Mr Andrew William Thornton & Mr John Herbert Thornton & Mrs Vivien Mary Russell, C/-Day Neilson Accountants, PO Box 1, Geelong	176.00	''	28/04/00
Peter Lindsay Thorpe, 27 Pacific Parade, Lennox Head, NSW	100.00	''	27/10/00
Yvonne Thorpe, 27 Ingham Avenue, Five Dock, NSW	100.00	''	''
Mr Glen Campbell Thorpe, "GCT Superannuation Fund A/c", 32 Santalum Street, Rivett, ACT	150.00	''	''
Timothy Kent Threlfall, 4/74 Victoria Street, Sandringham	100.00	''	''
Ernest Thring, 3 Boona Court, Karawa, WA	100.00	''	''
Edward Phillip Thurley, 2/13 Gairloch Drive, Frankston	208.00	''	28/04/00
Mr Lisa Kathryn Tickner, PO Box 991, Horsham	112.00	''	''
Mr Lisa Kathryn Tickner, PO Box 991, Horsham	140.00	''	27/10/00
Tidah Holdings Pty Ltd, "Super Fund A/c", 50 St Thomas Street, Waverley, NSW	120.00	''	''
Elizabeth Phair Tierney, GPO Box 546, Adelaide, SA	120.00	''	28/04/00
Kathleen Tierney, 106/50 Murray Street, Pyrmont, NSW	120.00	''	''
Kevin C. Tilbey, 22 Pacific Boulevard, Beaumaris	256.00	''	''
Kevin C. Tilbey, 22 Pacific Boulevard, Beaumaris	320.00	''	27/10/00
Tile Trading Super Fund, 55 Boyle St, Balgowlah, NSW	217.20	''	28/04/00
Mark Timanowicz, 5 Marsh Street, Altona North	100.00	''	27/10/00
Alby Timleris & Grace Timleris, PO Box 552, Narrogin, WA	200.00	''	''
George Ormonde Timms, PO Box 378, Collie, WA	166.15	''	28/04/00
George Ormonde Timms, PO Box 378, Collie, WA	275.00	''	27/10/00
Joe Timpano & Nancy Timpano, 18 Walker Street, Moonee Ponds	120.70	''	28/04/00

Tims Bookshop Pty Ltd, 121 High Street, Kew	160.00	''	27/10/00
Mr Gregory C. Tingle, 2/9 New Oneans Court, Maroubra, NSW	160.00	''	28/04/00
Tiszulu Pty Limited, 32 Longmore Street, St Kilda West	181.30	''	''
Tiszulu Pty Limited, 32 Longmore Street, St Kilda West	300.00	''	27/10/00
Simon Jen Dju Tjia, "Family A/c", 57 Matisse Drive, Templestowe	100.00	''	''
TMA Investments Pty Ltd, "Bundoora Motors S/Fund A/c", C/- Black & Krantz, Level 3, 222 Kingsway, South Melbourne	200.00	''	''
Suk Chun To, 17 Isabella Crescent, Manning, WA	592.00	''	28/04/00
Suk Chun To, 17 Isabella Crescent, Manning, WA	740.00	''	27/10/00
Loan Ngoc To, 3 Larpent Street, Amaroo, ACT	160.00	''	''
Tobari Pty Limited, "No 1 GF A/c", PO Box 343, Spit Junction, NSW	160.00	''	28/04/00
Est Raymond Henry Tobias & Mr Robert William Tobias, 4/6 Longworth Avenue, Point Piper, NSW	100.00	''	27/10/00
Mr Dean Tobin, 68 Warrah Road, Yowie Bay, NSW	200.00	''	''
Serena Todd, 6 Tregoyd Gardens Estate, 161 Raglan Street, Balmoral, NSW	120.00	''	''
Zoran Todorovski, 13 Jutland Avenue, Wollongong, NSW	150.00	''	''
Mr Jeffery Edwin Toghil, PO Box 266, Cremorne, NSW	100.00	''	''
Heng Jin Toh, 1 Akuna Street, Keiraville, NSW	120.70	''	28/04/00
Heng Jin Toh, 1 Akuna Street, Keiraville, NSW	200.00	''	27/10/00
Heng Jin Toh, "Christian Sieu-Wen Toh A/c", 1 Akuna Street, Keiraville, NSW	120.70	''	28/04/00
Mr Eoelie Tohme, 1165 Victoria Road, Westride, NSW	100.00	''	27/10/00
Luisa Marisa Toich, 5/99 Caroline Street, South Yarra	160.00	''	28/04/00
Helen Tolhurst, 35 Doulton Drive, Cherrybrook, NSW	400.00	''	27/10/00
Tolis Pty Ltd, C/- The Lunch Club, 18/19 204 Unley Road, Unley, SA	160.00	''	''
David Rodney Tolliday, 5/59-61 Ormond Esplanade, Elwood	120.00	''	28/04/00
David Rodney Tolliday, 5/59-61 Ormond Esplanade, Elwood	150.00	''	27/10/00
Deborah Toman, 155 Garnet Road, Kareela, NSW	224.00	''	28/04/00
Joanne Mary Tompson, 18 Hawthorn Place, Cherrybrook, NSW	120.70	''	''
Joanne Mary Tompson, 18 Hawthorn Place, Cherrybrook, NSW	200.00	''	27/10/00
Robert Ian Tompson & Norrazaliswah Tompson, 50/480 The Kingsway, Miranda, NSW	100.00	''	''
Cemented Carbide Tools & Dies (Aus) Pty Ltd, "Staff Super Fund A/c", PO Box 48, Surrey Hills North	189.90	''	28/04/00
Top House Pty Ltd, "Fort Amity Family A/c", C/Invia Custodian Pty Ltd, GPO Box 4595 SS, Melbourne	112.00	''	''
Toplis And Harding Marine (Vic) Pty Ltd, PO Box 530, Ringwood	150.00	''	27/10/00
Malcolm R. Tor'bey, 2A Balmerino Avenue, Toorak	148.00	''	28/04/00
Sonia Toro, 16 Koala Avenue, Ingleburn, NSW	100.00	''	27/10/00
Jeanette Torpey, 1 Premier Street, Toongabbie, NSW	160.00	''	28/04/00
Jeanette Torpey, 1 Premier Street, Toongabbie, NSW	200.00	''	27/10/00
Sarah Ann Torr, "Possum Family A/c", PO Box 1126, Albany DC, WA	100.00	''	''

Toscana Holdings, "Whubbard Family A/c", PO Box 492, Willetton, WA	164.25	"	28/04/00
Toscana Holdings, "Whubbard Family A/c", PO Box 492, Willetton, WA	272.00	"	27/10/00
Total Quality Service Pty Ltd, 36 Kent Hughes Rd, Eltham	217.60	"	28/04/00
Total Quality Service Pty Ltd, 36 Kent Hughes Rd, Eltham	272.00	"	27/10/00
Marc Totaro, 20 Connor Place, Illawong, NSW	108.00	"	"
Suzanne Totaro, 20 Connor Place, Illawong, NSW	108.00	"	"
Rod Ray Toth, 5 Gatherer Crescent, Mt Isa, Qld	256.00	"	28/04/00
Toto Investments Pty Ltd, 1 Albert Street, Richmond	120.00	"	27/10/00
Arthur Townsend, 20 Georgia Grove, Corio	192.00	"	28/04/00
Constance Andrea Townsend, C/- Mrs Om Catford, 13 William Street, Hawthorn, SA	150.00	"	27/10/00
Trevor E. Toy, 4 Taeping Street, Hallett Cove, SA	100.00	"	"
TPR Asset Management Pty Ltd, "Coralton Super Fund A/c", PO Box 2203, St Kilda West	200.00	"	"
Lee Max Trading, "St Helena Radiology A/c", 212 Aqueduct Road, Diamond Creek	140.00	"	"
Tradwyn Pty Ltd, 89 Balaclava Road, Eastwood, NSW	100.00	"	"
Steve Trajcevski, 10 Sparta Place, Bossly Park, NSW	200.00	"	"
Quoc Hung Tran, 38 Wisdom Road, Greenwich, NSW	164.25	"	28/04/00
Quoc Hung Tran, 38 Wisdom Road, Greenwich, NSW	272.00	"	27/10/00
Mr John Tran & Mrs Diana Tran, 346 Hamilton Road, Fairfield West, NSW	200.00	"	"
Tran Tran & Trien Tran, 5 Kooyong Street, St Johns Park, NSW	307.20	"	28/04/00
Thien Huu Tran, 19 Kiewa Street, Kaleen, ACT	100.00	"	27/10/00
Vien Tuong Tran, 24 Kessell Avenue, Homebush West, NSW	118.00	"	"
Hoang N Tran, 2 Kurrajong Drive, Altona Meadows	132.85	"	28/04/00
Hoang N Tran, 2 Kurrajong Drive, Altona Meadows	154.60	"	27/10/00
Hoang N Tran, 2 Kurrajong Drive, Altona Meadows	220.00	"	"
Ms Ngoc My Tran, 28 Buckingham Street, Footscray	100.00	"	"
Mr The Khanh Tran, 4 Ashgrove Street, St Johns Park, NSW	514.50	"	"
Duy-Vien Tran, 434 North Rocks Road, Carlingford, NSW	125.65	"	28/04/00
Duy-Vien Tran, 434 North Rocks Road, Carlingford, NSW	208.00	"	27/10/00
Tradox Pty Ltd, 95 Hutt Street, Adelaide, SA	104.00	"	"
Mr Patrick Francis Trapnell, 8A Algona Street, Holland Park West, Qld	212.00	"	"
Ashley Traynor, 7 Sylvan Way, Grange, SA	240.00	"	"
Tree Placers Australia Pty Ltd, "F Stuart Holdings S/F A/c", 8 Somerset Road, Glen Iris	100.00	"	"
Terrence Corin Tregoning, 7/26 Searl Road, Cronulla, NSW	126.75	"	28/04/00
Terrence Corin Tregoning, 7/26 Searl Road, Cronulla, NSW	210.00	"	27/10/00
Tres Bien Investments Pty Ltd, Level 8/233 Adelaide, Perth, WA	112.00	"	28/04/00
Tres Bien Investments Pty Ltd, Level 8/233 Adelaide, Perth, WA	140.00	"	27/10/00
Brett Trevena, 14 Russell Street, Caulfield South	100.00	"	"
Veroncia Ellen Trewin, PO Box 28, Bulla	160.00	"	28/04/00
Veroncia Ellen Trewin, PO Box 28, Bulla	200.00	"	27/10/00
Dianne Tribe, T. & S. & J. Tribe A/c, 4 Lagoon Court, Blackburn	270.00	"	"
Graeme William Trigg, 487 Woodspoint Rd, East Warburton	100.00	"	"

Tringa Investments Pty Ltd, "Aj Cassidy A/c", 33 Chapman Road, Geraldton, WA	100.00	"	"
Tringa Investments Pty Ltd, "SA Cassidy A/c", 33 Chapman Road, Geraldton, WA	100.00	"	"
Tringa Investments Pty Ltd, "Cassidy Super Fund", C/- 33 Chapman Road, Geraldton, WA	100.00	"	"
Phuoc-Ly Trinh & Hoang Dung Trinh & Mai Huong Trinh, 51 Richelpeu Street, Maidstone	104.00	"	"
Mr Ross Trinh, 5/12 Stanley Street, Box Hill South	100.00	"	"
Mrs Lee Trinh & Mrs Tam Hong Tran & Mrs Hong Phan, 38 Orchard Street, Glen Waverley	150.00	"	"
Trinrose Pty Ltd, "The Trinrose S/Fund A/c", 57 Raglan St, Mosman, NSW	241.45	"	28/04/00
Trinrose Pty Ltd, "The Trinrose S/Fund A/c", 57 Raglan St, Mosman, NSW	400.00	"	27/10/00
Tripodi Enterprises Pty Ltd, "Super Fund A/c", 83 Park Terrace, Salisbury, SA	192.00	"	28/04/00
Rohan Tronson, 21 Eagle Creek Road, Werombi, NSW	140.00	"	27/10/00
Joseph Alfred Trudgeon, 43 Ebeli Close, Narre Warren North	132.85	"	28/04/00
Van Sen Truong & Thi Ngoc Ha Doan, "Family Truong A/c", 4 Skone Street, Condell Park, NSW	315.00	"	27/10/00
Lukito Truong, 5 Monaro Street, Seven Hills, NSW	100.00	"	"
Albert Tsang, 8 Reef Street, Quakers Hill, NSW	200.00	"	"
Ms Chu-Lan Tseng, 5fF-1 No 1 Lane 102, Chi-Hsing Road, Chiao-Chou, Ping-Tong Taiwan	591.20	"	28/04/00
Yoko Tsunoda, 15/11 Myahgah Road, Mosman, NSW	150.00	"	27/10/00
Rita Tsyprun & Gregory Tsyprun, 10/52-54 Warners Avenue, Bondi, NSW	100.00	"	"
Frank Tuan & Sandra Tuan, McFarlane Street, East Keilor	100.00	"	"
Quintin Tuan, "Rodolfa Tuan A/c", 10 Shelley St, Keilor East	100.00	"	"
Rodolfo James Tuan, 10 Shelley Street, Keilor East	252.00	"	28/04/00
Rodolfo James Tuan, 10 Shelley Street, Keilor East	315.00	"	27/10/00
Marilyn Tuan, 10 Shelley Street, Keilor East	112.00	"	28/04/00
Marilyn Tuan, 10 Shelley Street, Keilor East	140.00	"	27/10/00
Dragon Tucic, Kapyong Coy, RMC Duntroon, Canberra, ACT	128.00	"	28/04/00
Dragon Tucic, Kapyong Coy, RMC Duntroon, Canberra, ACT	160.00	"	27/10/00
George Henry Tucker, 24 Nicker Crescent, Alice Springs, NT	112.00	"	28/04/00
Mr Benjamin Tucker, 13 Leslie Street, Richmond	108.00	"	27/10/00
Geoff Tuke, PO Box 796, Scarborough, WA	160.00	"	28/04/00
Geoff Tuke, PO Box 796, Scarborough, WA	200.00	"	27/10/00
Ross Tulloch, 5/4 Wetherill Street, Narrabeen, NSW	100.00	"	"
Yilmaz Tuncer, 30 Myrnong Crescent, Ascot Vale	200.00	"	"
Claudio Tuniz & Patrizia Tiberi Vipraio, 217 Edgecliff Road, Woollahra, NSW	212.00	"	"
Rosalie Tuohy, 4 Cawkwell Street, Malvern	140.00	"	"
Mario Luciano Turcinovich & Daniel James A. Turcinovich, 367 Gaffney St, Pascoe Vale	100.00	"	"
Mr Alexander Bernard Turkovic, 22 Glenmore St, Macleod	120.00	"	28/04/00
Mr John Turley, Unit 21 Riviera Apartments, 50 Lower River Terrace, South Brisbane, Qld	100.00	"	27/10/00
Glenn Alexander Turnbull, 26 Dalby Street, Maroochydore, Qld	100.00	"	"

Turnbull Jackson & Basile Pty, "Super Fund A/c", PO Box 45, Ringwood East	100.00	"	"
Elaine Turner, PO Box 4, Toowoomb Bay, NSW	100.00	"	"
Michael Turner, 113 Wheeler Crescent, Wanniasa, ACT	180.00	"	"
Alan Gregory Turner, 94 Fawcett Street, Glenfield, NSW	185.00	"	"
Ms Carolann Turner, 94 Fawcett Street, Glenfield, NSW	185.00	"	"
Mr Mark John Turner, 3/15 Ware Avenue, Wodonga	240.00	"	"
Mrs Gilda Barbara Turner, Locked Bag 42, Ivanhoe	192.00	"	28/04/00
Robin Anne Turner & Stephen John Turner, 120 Evans Road, Lovely Banks	155.15	"	"
Tut Systems Australia Pty Ltd, 4 St Pauls Road, North Balgowlah, NSW	100.78	"	"
Tv Corporation Pty Ltd, 18 Mellor St, West Ryde, NSW	700.00	"	27/10/00
Michael Tveshor & Igor Brook, North East Dental Services, 235 Oxford Street, Bondi Junction, NSW	246.40	"	28/04/00
Maria Twarkowski, Flat 18, 36 Buckland Street, Chippendale, NSW	120.00	"	"
Maria Twarkowski, Flat 18, 36 Buckland Street, Chippendale, NSW	150.00	"	27/10/00
Kazimierz Twarkowski, 6 Corby Place, Chipping Norton, NSW	150.00	"	"
Ms Eva Twarkowski, 18/36 Buckland Street, Chippendale, NSW	120.00	"	28/04/00
Ms Eva Twarkowski, 18/36 Buckland Street, Chippendale, NSW	150.00	"	27/10/00
Mr Gerald Twarkowski, 6 Corby Place, Chipping Norton, NSW	550.00	"	"
Mr Gerald Twarkowski & Mrs Belinda Anne Twarkowski, 18/36 Buckland Street, Chippendale, NSW	400.00	"	28/04/00
Kathleen Mary Tweedie & Noel Francis Tweedie, 21 Newman Court, Berwick	100.00	"	27/10/00
Patricia Twomey & Ronald Twomey, 2 Chevron Court, Wendouree,	100.00	"	"
Mark Twycross, PO Box 2979EE Melbourne, 29 Bellevue Court, Mount Eliza	120.70	"	28/04/00
Benjamin Thomas Tylich, 10 Creer Court, Noranda, WA	100.00	"	27/10/00
Mr Eamonn Patrick Tynan, 51 Droop Street, Footscray	500.00	"	28/04/00
Mr Eamonn Patrick Tynan, 51 Droop Street, Footscray	625.00	"	27/10/00
Mr Mark Shane Tyndall, 19 Norongo Street, O'Sullivan Beach, SA	100.00	"	"
Peter Richard Tyson, 13 Gladys Ave, Frenchs Forest, NSW	120.70	"	28/04/00
Premjit Uberoi, 16 Crace Street, Weetangera, ACT	132.85	"	"
Premjit Uberoi, 16 Crace Street, Weetangera, ACT	220.00	"	27/10/00
Anne Ullmann, 9 Winston Drive, Doncaster	114.20	"	"
Mrs Vivien Umow, 5 Devon Street, Caulfield	100.00	"	"
Underline Pty Ltd, 1/627 Chapel Street, South Yarra	100.00	"	"
Ms Chen Lam Ung, 28 Kara Crescent, Para Hills, SA	100.00	"	"
Ms Carolyn Unwin, Unit 5/15 Barry St, Neutral Bay, NSW	200.00	"	"
Jatinder Singh Uppal, PO Box 343, South Melbourne	100.00	"	"
Upper Kensington Investments Pty Ltd, PO Box 46, Kensington Park, SA	100.00	"	"
Urban Holdings Pty Ltd, 3 Swallow Court, Churchlands, WA	120.00	"	"

Lynette Usher & Douglas Usher, 38 Spring Street, Abbotsford, NSW	220.00	''	''
Mr Robert Warren Usher & Mrs Glenda Gay Usher, "Super Fund A/c", PO Box 5131, Townsville, Qld	150.00	''	''
Mr Chirstopher Robert Vagg, 2/4 Hay Street, Neutral Bay, NSW	100.00	''	''
Anna-Rita Vallelonga, 9 Eldwick Loop, Swan View, WA	120.00	''	28/04/00
Chrissie Vallianos & John Vallianos, "Vallianos Super Fund A/c", 5 Oakwood Avenue, Brighton	100.00	''	27/10/00
Paul Raymond Vallier, 49 Manooka Crescent, Bradbury, NSW	200.00	''	''
Vamora Pty Ltd, 11/26 Lower River Terrace, Brisbane, Qld	400.00	''	28/04/00
Mr Dat Tan Van, 9 Rosalie Court, Kidman Park, SA	301.55	''	''
Ms Arie Van Bockel, PO Box 1179, Unanderra, NSW	150.00	''	27/10/00
Jefferson Bruce Van Groningen, 42 Grosvenor Drive, Wandana Heights	104.00	''	''
Van To & Lien To, 18 Nelson Street, Kilburn, SA	264.00	''	''
Van-King Consulting Pty Ltd & Engelina Susan Van Dyk, 34 Cecil Street, Fitzroy	100.00	''	''
Vanable Pty Limited, C/- Bmf Investment Services Pl, Level 53, MLC Centre, 19 Martin Place, Sydney, NSW	164.00	''	''
Vanable Pty Ltd, C/- BMF Investment Services Pl, Level 53, MLC Centre, 19 Martin Place, Sydney, NSW	164.00	''	''
Mr Simon Joseph Vandelig, Unit 3, 2 Durrant St, Brighton	100.00	''	''
Mrs Sonja Elizabeth Vanderklau, 10 Peters Place, Morley, WA	112.00	''	28/04/00
Kristine Vandertop, "Rhima Australia Pty Ltd", 1 University Place, Mulgrave	128.00	''	''
Kristine Vandertop, "Rhima Australia Pty Ltd", 1 University Place, Mulgrave	160.00	''	27/10/00
Andrew Procopis Vanezis, 10/66 Shirley Road, Wollstonecraft, NSW	200.00	''	''
Mr William Vankley, C/- The Office of The Protective Commissioner, PO Box A248, Sydney South, NSW	369.50	''	28/04/00
Mr William Vankley, C/- The Office of The Protective Commissioner, PO Box A248, Sydney South, NSW	500.00	''	27/10/00
Hendrikus Vanleent, "Lisa Vanleent A/c", 38 Mustang Street, Winston Glades, Qld	100.00	''	''
William C Vanmierlo & Kathleen E McCracken, PO Box 309, Mossman, Qld	100.00	''	''
Mr Peter Vardoulakis, 57a Hinkler Road, Glen Waverley	150.00	''	''
Mr John Vassos, 11A Westgarth Street, Northcote	169.20	''	28/04/00
Mr Leonardo Vaticano, 24 Pickwick Street, Cannon Hill, Qld	100.00	''	27/10/00
Stella Vaughan, 28 Stanley Street, Queens Park, NSW	112.00	''	28/04/00
Francis Kevin Vaughan, "Vaughan Family A/c", 1 Silver Ash Avenue, Ashwood	169.60	''	''
Francis Kevin Vaughan, "Vaughan Family A/c", 11 Silver Ash Avenue, Ashwood	212.00	''	27/10/00
Kenneth John Vaux, "KJ Vaux Practice Super Fund A/c", 8A Wonga Wonga Street, Turrumurra, NSW	150.00	''	''
Mrs Gillian Madeline Veal, Unit 1, 41 Station Rd, Rosanna	120.00	''	''
Gary John Veale, PO Box 2075, Gateshead, NSW	280.00	''	''

Mr Jarrod Christopher Veitch, 6/44–46 Golf Avenue, Mona Vale, NSW	120.00	”	28/04/00
Robert S. Velins, 26 Barrett Street, Albert Park	295.50	”	”
Robert S. Velins, 26 Barrett Street, Albert Park	490.00	”	27/10/00
Goran Veljovic & Nevena Veljovic, 15 Delmont Court, Endeavour Hills	100.00	”	”
M/S Karen Juanita Vella, 936 South Pine Road, Everton Hills, Qld	208.00	”	28/04/00
Mr Ian David Vella & Mrs Margaret Anne Vella, PO Box 251, Everton Park, Qld	134.00	”	27/10/00
Anthony Vendramini, 972 Drummond St, Carlton North	160.00	”	28/04/00
Anthony Vendramini, 972 Drummond St, Carlton North	200.00	”	27/10/00
Sedina Veneran, 29 Lindsay Street, Bulleen	126.75	”	28/04/00
Sedina Veneran, 29 Lindsay Street, Bulleen	210.00	”	27/10/00
Belinda Danielle Veneran, 29 Lindsay Street, Bulleen	160.00	”	”
Sedina Veneran, 29 Lindsay Street, Bulleen	150.00	”	”
Ms Belinda Danielle Veneran, 29 Lindsay Street, Bulleen	100.00	”	”
Ventek Corporation P/L, 31 Market Street, Sydney, NSW	362.15	”	28/04/00
Ventrust Pty Limited, C/- McConnell Jaffray Lawyers, Level 13, 74 Castlereagh Street, Sydney, NSW	301.55	”	”
Verlis Promotions Pty Ltd, PO Box 23, Penrith, NSW	100.00	”	27/10/00
Mrs Helen Vernadakis, “Nathan Barry Vernadakis A/c”, 43 Yarra St, Williamstown	100.00	”	”
Mrs Helen Vernadakis, “Rene Nicole Vernadakis A/c”, 43 Yarra St, Williamstown	100.00	”	”
Julie Maris Verrone, 6/18 Courland Street, Randwick, NSW	100.00	”	”
Delores Vey-Cox, 250 The Grand Parade, Ramsgate Beach, NSW	150.00	”	”
Victorian Meat Traders Pty Ltd, PO Box 276, Dandenong	100.00	”	”
Mr Paul Andrew Victory, 14 Walkers Road, Somerton Park, SA	140.00	”	”
Vidanca Pty Ltd, C/- Mr Murray D. Cornish, 52 Norris Street, Hermit Park, Qld	151.00	”	28/04/00
Vidanca Pty Ltd, C/- Mr Murray D. Cornish, 52 Norris Street, Hermit Park, Qld	250.00	”	27/10/00
Baly Vidugiris, 43 Grieve Parade, Altona	200.00	”	”
Darshan Vigneswaran, 58 Fourth Avenue, St Peters, SA	100.00	”	”
Neville Villiers, 46 Kempzie Road, Upper Mt Gravatt, Qld	100.00	”	”
Vilmos Pty Ltd, “Panaccio Family A/c”, 47 Hawthorn Grove, Hawthorn	224.35	”	28/04/00
Vilmos Pty Ltd, “Panaccio Family A/c”, 47 Hawthorn Grove, Hawthorn	372.00	”	27/10/00
Vilmos Pty Ltd, “Panaccio Family Trust A/c”, 47 Hawthorn Grove, Hawthorn	120.70	”	28/04/00
Vilmos Pty Ltd, “Panaccio Family Trust A/c”, 47 Hawthorn Grove, Hawthorn	200.00	”	27/10/00
Kurt Vilo, 2/26 Bennett Street, Bondi, NSW	100.00	”	”
Vilos Pty Ltd, “Trenowden Super Fund A/c”, PO Box Y3135, Perth, WA	102.40	”	28/04/00
Vilos Pty Ltd, “Trenowden Super Fund A/c”, PO Box Y3135, Perth, WA	128.00	”	27/10/00
Stephen John Vineburg, 5 Gowrie Avenue, Bondi Junction, NSW	100.00	”	”

Joseph Anthony Virgona, 16 Buckland Avenue, Newtown	100.00	''	''
Vistula Pty Ltd, "JA & DL Sutherland S/Fd A/c", C/-Perpetual Trustees WA Ltd, GPO Box 5106, Sydney, NSW	120.00	''	''
Jim Vitale, 12 Salisbury Street, Coburg	212.00	''	''
Jeffrey Norman Vitnell, "Matthew & Lauren A/c", 46 Gunida Street, Mullaloo, WA	130.00	''	''
Nerida Vitomir, 67 Cooper Street, Maroubra, NSW	134.00	''	''
Mr George Vitsas, 11 Ford Road, Altona	100.00	''	''
Vivid Ink Pty Ltd, "Super Fund No 1 Account", Attn M/s Anita Dawes, PO Box 478, Harbord, NSW	120.70	''	28/04/00
Vivid Ink Pty Ltd, "Super Fund No 1 Account", Attn M/s Anita Dawes, PO Box 478, Harbord, NSW	200.00	''	27/10/00
Vivienne Nominees Pty Ltd, PO Box 3004, Doncaster East	241.45	''	28/04/00
Mr Alan Vlubosky, 29 Plowman Street, Bondi, NSW	100.00	''	27/10/00
Mrs Rosemary Jean Vohmann, 19 Redleaf Way, Wheelers Hill	100.00	''	''
Michael Von Treifeldt, 33 Ballarat Street, Fisher, ACT	100.78	''	28/04/00
Michael Von Treifeldt, 33 Ballarat Street, Fisher, ACT	166.60	''	27/10/00
Vorn Enterprises Pty Limited, "Superannuation A/c", Level 7, 40 Queen Street, Brisbane, Qld	3,014.00	''	28/04/00
Tereza Vorosova, 44 Mons Avenue, Maroubra, NSW	120.70	''	''
Tereza Vorosova, 44 Mons Avenue, Maroubra, NSW	200.00	''	27/10/00
Votrait 856 Pty Limited, C/- Moores, PO Box 338, St Leonards, NSW	288.00	''	28/04/00
Votrait No 617 Pty Ltd, "Borsch Belt A/c", 37 Benelong Crescent, Bellevue Hill, NSW	728.49	''	''
Votrait No 617 Pty Ltd, "Borsch Belt A/c", 37 Benelong Crescent, Bellevue Hill, NSW	1,208.30	''	27/10/00
Fotini Fay Vranas & Peter Vranas, "N. Vranas A/c", 5 Merriman Street, Kyle Bay, NSW	100.00	''	''
VRB Holdings Pty Ltd, 88 Claremont Avenue, Malvern	235.00	''	''
Andrew Jesse Vueti & George Enrico Misso, PO Box 1032, Cranbourne	200.00	''	''
Khyam S. Vun, 18 Madigan Drive, Glen Waverly	320.00	''	''
Mrs Shun Fong Vun, 18 Madigan Drive, Glen Waverley	120.00	''	''
W A Management Services Pty Ltd, 12 Berrima Rd, Donvale	155.15	''	28/04/00
Ms Lisa Waddell, 289 Moray Street, South Melbourne	160.00	''	27/10/00
Mr Quentin Edward Waddell, 56 Salisbury Road, Stanmore, NSW	200.00	''	''
Steve Waddingham & Nicholle Annette Bell, 10 Eldon Street, Dianella, WA	100.00	''	''
Ruby Joyce Waddington, 4/36 Milner Crescent, Wollstonecraft, NSW	100.00	''	''
Yvonne June Wade, 122 Mans Road, Gosford, NSW	120.70	''	28/04/00
Mrs Anita Kim Wagg, 356 Reynolds Road, Research	120.70	''	''
Mrs Anita Kim Wagg, 356 Reynolds Road, Research,	200.00	''	27/10/00
Jordan Wainer, 4 Mons Street, Vacluse, NSW	100.00	''	''
Wairoa Trust Pty Ltd, PO Box S46, Adelaide, SA	240.00	''	28/04/00
Wairoa Trust Pty Ltd, PO Box S46, Adelaide, SA	300.00	''	27/10/00
Alfred James Wait, 14 Atkinson Street, Manunda, Qld	100.00	''	''
John Harold Waite, 9/8 Ray Street, South Perth, WA	102.40	''	28/04/00
John Wakerman, "Misha Wakerman A/c", 24 Burke Street, Alice Springs, NT	100.00	''	27/10/00

John Wakerman, "Saul Wakeman A/c", 24 Burke Street, Alice Springs, NT	110.00	"	"
John Wakerman, 24 Burke Street, Alice Springs, NT	108.60	"	28/04/00
John Wakerman, 24 Burke Street, Alice Springs, NT	180.00	"	27/10/00
David J Waldie, 5/56 Hewlett Street, Bronte, NSW	100.00	"	"
Brian Earl Walker & Clare Ann Walker, 156 Botanical Circuit, Banora Point, NSW	200.00	"	"
Beth Walker, 38 Union Street, Brighton East	100.78	"	28/04/00
Beth Walker, 38 Union Street, Brighton East	166.60	"	27/10/00
Judith Walker, 177 Shannon Avenue, Geelong West	100.00	"	"
Bruce Walker, 23 Findon Crescent, Kew	160.00	"	28/04/00
Bruce Walker, 23 Findon Crescent, Kew	200.00	"	27/10/00
Mr Chris Walker, GPO Box 35, Brisbane, Qld	100.00	"	"
Wayne V. Walker, "WV Walker & Assoc A/c", 50 Rampart Way, Willetton, WA	120.00	"	"
Lewis Walker, 11 Lena Street, Mount Pritchard, NSW	265.60	"	28/04/00
Lewis Walker, 11 Lena Street, Mount Pritchard, NSW	332.00	"	27/10/00
Victor John Wall & Patricia Mary Wall, 15 Jordan Terrace, Bowen Hills, Qld	100.00	"	"
Rosa Wall, 23, Barcoo Street, East Roseville, NSW	160.00	"	"
Glenn William Wallace, 73 Judd Street, Mortdale, NSW	100.00	"	"
James Kenneth Wallace, 8 Kennedy Street, Keilor	128.00	"	28/04/00
James Kenneth Wallace, 8 Kennedy Street, Keilor	160.00	"	27/10/00
Timothy Joseph Wallace, 65 Chelmsford Street, Newtown, NSW	150.00	"	"
Graham Arthur Wallace, 11 Martini Street, Exeter, SA	100.00	"	"
Helen Jane Wallace, 2 Golf Links Road, Barwon Heads	169.60	"	28/04/00
Mr Matthew Wallace, 8 Milham Avenue, Eastwood, NSW	108.00	"	27/10/00
Wayne Wallace, 501/102 Wells St, South Melbourne	160.00	"	"
Est Derk Wallinga, C/- Goldstein Partners, PO Box 115, Ivanhoe	256.00	"	28/04/00
Peter John Wallis & Susan Wynn Wallis, "Wallis Super Fund A/c", 20 Woodford Street, Longueville, NSW	100.00	"	27/10/00
Peter Richard Walsh, 37 Vista Street, Bayview Heights, Qld	112.00	"	28/04/00
Peter Richard Walsh, 37 Vista Street, Bayview Heights, Qld	140.00	"	27/10/00
Lois Walters, 5 Quamby Place, Noosa Heads, Qld	120.00	"	28/04/00
Lois Walters, 5 Quamby Place, Noosa Heads, Qld	150.00	"	27/10/00
Barbara Anne Walters & Peter James Walters, 192 Epsom Avenue, Belmont, WA	120.00	"	"
Ming Qiu Wang & Zhi Xian Sheng, PO Box 829, Ashfield, NSW	348.00	"	28/04/00
Ming Qiu Wang & Zhi Xian Sheng, PO Box 829, Ashfield, NSW	435.00	"	27/10/00
Ming Gong Wang, 16/828 Canterbury Rd, Roselands, NSW	300.00	"	"
Dennis Wang, 40 Wentworth Street, Birrong, NSW	216.00	"	28/04/00
Dennis Wang, 40 Wentworth Street, Birrong, NSW	270.00	"	27/10/00
Meng Wang, 15 Central Avenue, Marrickville, NSW	197.60	"	28/04/00
Mr Yi Jing Wang, PO Box 55, Campsie, NSW	240.00	"	27/10/00
Min Wang, Unit 12, 26 Ashley Street, Reservoir	100.00	"	"
Wu Chiad-Er Wang & Yang-Jun Wang & Ting-Wei Wang, 96 Merrivale Lane, Turrumurra, NSW	100.00	"	"

Esheng Wang, PO Box 278, Camperdown, NSW	108.00	''	''
Mrs Selina Waples, 137 Hopetoun Avenue, Vaucluse, NSW	100.00	''	''
Thilak Waran, 21 Dorothy Street, Denistone East, NSW	132.80	''	28/04/00
Thilak Waran, 21 Dorothy Street, Denistone East, NSW	166.00	''	27/10/00
Mr Daniel Warbrick, C/- Rip Curl Pty Ltd, Attn Monica Little, 101 Surfcoast Highway, Torquay	100.00	''	''
Clifford Robert Ward, 27 Plateau Parade, Bray Park, Qld	308.00	''	28/04/00
Clifford Robert Ward, 27 Plateau Parade, Bray Park, Qld	385.00	''	27/10/00
Julie Ward, 10 Maxwell Street, Mona Vale, NSW	128.00	''	28/04/00
Julie Ward, 10 Maxwell Street, Mona Vale, NSW	160.00	''	27/10/00
Malcolm Ward, 13 Good Govers Sreet, Mitcham	100.00	''	''
Ms Tiffany Wardley, 35 Foch Street, Mowbray, Tas.	192.95	''	28/04/00
Ms Tiffany Wardley, 35 Foch Street, Mowbray, Tas.	320.00	''	27/10/00
Mr Ian Theodore Warfield, "Ian Theodore Warfield Superannuation Fund A/c", 122 Murrnaji Street, Hawker, ACT	100.00	''	''
Peter Warne, 21 Prince Albert Street, Mosman, NSW	288.00	''	28/04/00
James Hastings Warne, 21 Prince Albert St, Mosman, NSW	256.00	''	''
Emma Alice Warne, 21 Prince Albert Street, Mosman, NSW	256.00	''	''
Mr Geoffrey Keith Warner, PO Box 1007, Subiaco, WA	181.30	''	''
John Philip Warren, PO Box R579, Royal Exchange, Sydney, NSW	160.00	''	''
John Philip Warren, PO Box R579, Royal Exchange, Sydney, NSW	200.00	''	27/10/00
Mr Peter Kevin Warren, 213 Pickles Street, Port Melbourne	100.00	''	''
John A. Warrick, 7 Stocks Avenue, Ashburton	108.00	''	28/04/00
John A. Warrick, 7 Stocks Avenue, Ashburton	135.00	''	27/10/00
Brett Warwick, 1/57 Elvira Street, Palmyra, WA	120.00	''	''
Washbusters Pty Ltd, 1 Walerna Road, Glen Iris	272.00	''	''
Jason Andrew Wasley, PO Box 425, Roxby Downs, SA	100.00	''	''
Peter Watene, PO Box 186, Riverton, Perth, WA	100.00	''	''
Anselm Waterfield, 8/9 Ruth Street, Naremburn, NSW	100.00	''	''
Mark Clifford Waters, 39 Murdock Street, Brunswick	160.00	''	28/04/00
Mark Clifford Waters, 39 Murdock Street, Brunswick	200.00	''	27/10/00
Mr Peter Waters, GPO Box 3810, Sydney, NSW	345.00	''	''
Watgania Investments Pty Ltd, PO Box S46, Adelaide, SA	480.00	''	28/04/00
Watgania Investments Pty Ltd, PO Box S46, Adelaide, SA	600.00	''	27/10/00
Victoria Watkins, 13A Park Road, Ringwood	110.00	''	''
Mr Russell Alwyn Watkins, "Russell Watkins Super A/c", 1 Arthur Street, Mosman Park, WA	400.00	''	28/04/00
Matthew John Watson, 12 Avalon Road, Springfield, NSW	140.00	''	''
Mr Ian Watson, 2 Clovelly Street, Watsons Bay, NSW	100.00	''	27/10/00
Ian Watson, "Sam Watson A/c", 2 Clovelly Street, Watsons Bay, NSW	100.00	''	''
Mr Ian Rickard Glenton Watson, 122 Clovelly Street, Watsons Bay, NSW	140.00	''	''
Ian Richard Glenton Watson, 158 Hopetoun Avenue, Watsons Bay, NSW	289.40	''	28/04/00
Ian Richard Glenton Watson, 158 Hopetoun Avenue, Watsons Bay, NSW	480.00	''	27/10/00
Margaret A Watson, 147 Hayrick Lane, Mooroolbark	100.00	''	''
Mr Alan James Watson, 11 Lyrebird Place, Ingleburn, NSW	160.00	''	''

Watswool Pty Ltd, 390 Coventry Street, South Melbourne Rosemary Louise Watt,	300.00	''	''
17 Stanbrook Avenue, Mount Ousley, NSW Roxanne Therese Watt & Garry James Watt,	100.00	''	''
47 Crown Street, Bellingen, NSW	100.00	''	''
Lyall Henry Watts, 12/823 Rathdowne Street, North Carlton	120.00	''	''
Ms Kylie Pearl Watts, 5/13 Crimea Street, St Kilda	100.00	''	''
Mr Robert John Waugh, 23 Goulburn Street, Seymour	212.00	''	''
Damon Peter Wavell-Smith, 25 Fleetway St, Morningside, Qld	100.00	''	''
Brian Thomas Wavell-Smith, 25 Fleetway St, Morningside, Qld	120.70	''	28/04/00
Brian Thomas Wavell-Smith, 25 Fleetway St, Morningside, Qld	200.00	''	27/10/00
Nicholas Wavell-Smith, 25 Fleetway St, Morningside	100.00	''	''
Michaela Wavell-Smith, 25 Fleetway Street, Morningside, Qld	100.00	''	''
Conor Wavell-Smith, 25 Fleetway Street, Morningside, Qld	100.00	''	''
Ann Wavell-Smith, 25 Fleetway Street, Morningside, Qld	100.00	''	''
Mrs Elizabeth Anne Wavell-Smith, 25 Fleetway Street, Morningside, Qld	160.00	''	''
Mr Richard John Weatherhead, 3B Salcombe Road, Ashford, Middlesex TW15 3BP United Kingdom	100.00	''	''
Christopher James Weaver & John Cyril Courier & Pamela Wendy Courier, 5 St Kinnord Street, Essendon	100.00	''	''
Margaret Vera Webb, 500/95 Winfield Road, North Balwyn	100.00	''	''
Glenn Webb, 14 Tyler Street, Echuca	100.00	''	''
John Webb, 5 Shiels Place, Curtin, ACT	140.00	''	''
Graeme Webb, 10 Fran Crescent, Rosanna	100.00	''	''
Miss Jannine Annette Webb, 82 Flinders Street, Mount Hawthorn, WA	100.00	''	''
Mr Danny Webb, 14 Watson Avenue, Rose Park, SA	170.00	''	''
Mr David Leslie Weber, 23/14A Chapel Street, St Kilda	100.00	''	''
Kay Wee, 13 Bradford Avenue, Kew	100.00	''	''
Bill Wee, 13 Bradford Avenue, Kew	100.00	''	''
William Wee, PO Box 806, Kew	100.00	''	''
Shalini Jana Weerasekera, Unit 2, 26 Wyndham Street, Herstone, Qld	200.00	''	''
Anil Tilak Weerasiri & Shanindra D. Weerasiri, "Anisha S/F Pty Ltd A/c", 133 Ivanhoe Parade, Ivanhoe	157.05	''	28/04/00
Miss Tamara Weerawardane, 3A Copenhagen Street, Islington, London N1 OJB, United Kingdom	355.00	''	27/10/00
Nicole Simone Weinberg, 5/206C Victoria Road, Bellevue Hill, NSW	106.40	''	28/04/00
Helen Weinstock, 5 The Promenade, Guildford, NSW	340.00	''	27/10/00
Amiram Weinstock, "Simon Weinstock A/c", 5 The Promenade, Guildford, NSW	340.00	''	''
Amiram Weinstock, "Adam Weinstock A/c", 5 The Promenade, Guildford, NSW	340.00	''	''
Amiram Weinstock, "Cara Weinstock A/c", 5 The Promenade, Guildford, NSW	340.00	''	''
Amiram Weinstock, "Joshua Weinstock A/c", 5 The Promenade, Guildford, NSW	340.00	''	''
Weisinger Nominees Pty Ltd, 2/12 Seymour Rd, Elsternwick	112.00	''	28/04/00
Weisinger Nominees Pty Ltd, 2/12 Seymour Rd, Elsternwick	140.00	''	27/10/00

Wembley Holdings Pty Limited, 2/116 Brighton Boulevard, Bondi, NSW	100.00	''	''
Wembley Holdings Pty Ltd, 2/116 Brighton Boulevard, Bondi Beach, NSW	200.00	''	''
Dr Richard George Wendel, 6722 Hammerstone Way, Cincinnati, Ohio 45227 USA	173.67	''	28/04/00
Cheok Weng Ao, 19 Coolas Street, Chadstone	120.00	''	27/10/00
June Wenham, 17 Fortescue St, Bexley North, NSW	200.00	''	28/04/00
Kenneth J. Wenham, 33 Angophora Place, Alfords Point, NSW	200.00	''	''
Kenneth J. Wenham, 33 Angophora Place, Alfords Point, NSW	250.00	''	27/10/00
Werberg Pty Ltd, 2/5 Parkinson Lane, Kardinya, WA	112.00	''	28/04/00
Sharon Michelle West, 2/12 Broadby Drive, Lenah Valley, Tas.	100.00	''	27/10/00
Carey Andrew West, 12 Leahy St, Port Augusta, SA	120.70	''	28/04/00
Carey Andrew West, 12 Leahy St, Port Augusta, SA	200.00	''	27/10/00
Stewart Graeme West, PO Box 1714, Bathurst, NSW	100.00	''	''
Mrs Alice May West, 12 Leahy Street, Port Augusta, SA	100.00	''	''
Mr Antony Brian West, PO Box Ge66, Garbutt East, Qld	120.00	''	''
Ross Leo West, 3 Garrard Street Granville, Granville, NSW	100.00	''	''
Ian C. West, Locked Bag 1311, Adelaide, SA	256.00	''	''
West Coast Building Co Pty Ltd, 43 Railway Parade, Mt Lawley, WA	100.00	''	''
Ian Bruce Westley, 61 Bayview Road, Belgrave	120.70	''	28/04/00
Ian Bruce Westley, 61 Bayview Road, Belgrave	200.00	''	27/10/00
Mr Anthony Francis Westmore, PO Box 69, Wynyard, Tas.	608.05	''	28/04/00
Mr Ken A Weston & Mrs Anne Weston, PO Box D1, Dural, NSW	151.00	''	''
John Anthony Westwood, 26 Avalon Street, Mooroolbark	100.00	''	27/10/00
Karen Weyer & Peter Gardener, 45 Nicholson Road, Shenton Park, WA	128.00	''	28/04/00
Wh Kuhnell Co Pty Ltd, PO Box S46, Adelaide, SA	640.00	''	''
Wh Kuhnell Co Pty Ltd, PO Box S46, Adelaide, SA	800.00	''	27/10/00
Wheatbelt Investments Pty Ltd, PO Box 220, Merredin, WA	100.00	''	''
Neville Elroi Wheaton, RMB 2082, Stawell	168.00	''	28/04/00
Neville Elroi Wheaton, RMB 2082, Stawell	210.00	''	27/10/00
Margaret Lynn Wheelahan, 3 Kurraba Rd, Neutral Bay, NSW	192.00	''	28/04/00
Margaret Lynn Wheelahan, 3 Kurraba Rd, Neutral Bay, NSW	240.00	''	27/10/00
Joanne Wheeler, 1a Leura Avenue, Hawthorne, Qld	128.00	''	28/04/00
Mrs Christine Mary Wheeler & Mr Robert Stanley Wheeler, 10 Parry Street, Claremont, WA	120.70	''	28/04/00
Richard Wheen & Lydian Wheen, "Wheen Super Fund A/c", 2A Prince Edward Ave, Mitcham	120.00	''	27/10/00
Mr David Mark Whelan, 1301/251 Oxford Street, Bondi Junction, NSW	480.00	''	28/04/00
Mr Mark Darren Whipp, 35 Harwood Street, Bardon, Qld	144.00	''	''
William White, 33 Cox Avenue, Bondi Beach, NSW	220.00	''	27/10/00
Victoria White & Louise White, 248 Park St, North Fitzroy	160.00	''	28/04/00
Peter James White, 21 Luxton Terrace, Seaford	100.00	''	27/10/00
Justin Denise White, 241 Davey Street, South Hobart, Tas.	100.00	''	''

Benjamin Michael White, Cnr Denham & Barrett, Brackenridge, Qld	320.00	''	''
David White, 25 Gertiude Street, Arncliffe, NSW	144.80	''	''
Damian Thomas Keogh & Maree Bernadette White, 28 North East Crescent, Lilli Pilli, NSW	1,000.00	''	''
Ms Catherine White, 3 Acheron Street, Doncaster	120.00	''	''
Mr Robert Andrew White, "Jarrod Lloyd White Account", 14 Greendale Road, Glen Iris	140.00	''	''
Franca White, "Annika L. Rzesnicwiecki A/c", 14 Greendale Hoad, Glen Iris	140.00	''	''
Deborah Maree White, 5/10 Grace Street, Lane Cove, NSW	100.00	''	''
Christopher White, Concrete Constructions, 100 Pacific Highway, St Leonards, NSW	120.00	''	''
Jennifer M. White, 31 Hazelton Grove, Charlestown, NSW	225.60	''	28/04/00
Jennifer M. White, 31 Hazelton Grove, Charlestown, NSW	282.00	''	27/10/00
Mrs Margaret Ann Whiting, 275 Sturt Road, Sturt, SA	100.00	''	''
Simon Preston Whittingham, PO Box 1470, Gladstone, Qld	226.00	''	''
Anna Whittle, 96 Stanley Street, North Adelaide, SA	176.00	''	28/04/00
Anna Whittle, 96 Stanley Street, North Adelaide, SA	220.00	''	27/10/00
R. J. Whybrow, "Super Fund A/c", 2/65 Berry Street, North Sydney, NSW	175.25	''	28/04/00
David John Whyte, 29 Gertrude Street, Arncliffe, NSW	150.00	''	27/10/00
Robert John Delapore Wickes & Roselyn Ann Wickes, 6 Seaview Street, Balgowlah, NSW	120.00	''	28/04/00
Robert John Delapore Wickes & Roselyn Ann Wickes, 6 Seaview Street, Balgowlah, NSW	150.00	''	27/10/00
Allan Barry Wickham & Anita Rose Wickham, 6 Pymble Avenue, Pymble, NSW	201.60	''	28/04/00
Allan Barry Wickham & Anita Rose Wickham, 6 Pymble Avenue, Pymble, NSW	252.00	''	27/10/00
Tom Wieteszka, 8/1 Milner Road, Artarmon, NSW	160.00	''	28/04/00
Hugh Higham Wigg, 18 Edwin Terrace, Gilberton, SA	120.00	''	27/10/00
Kevin James Wignell, 110 Yarrbat Avenue, Balwyn	300.00	''	''
Mr William Chandra Wijaya, C/- 1 Science Centre Road, Mcdermott Sth East Asia, Pte Ltd 6090777	546.86	''	28/04/00
Wilart Pty Ltd, "Wilart Pty Ltd S/Fund A/c", PO Box 46, Pambula, NSW	120.70	''	''
Wilart Pty Ltd, "Wilart Pty Ltd S/Fund A/c", PO Box 46, Pambula, NSW	200.00	''	27/10/00
Wild Holly Cakes Pty Ltd, "Super Fund A/c", 389 Bay Street, Brighton	100.00	''	''
Peter Joseph Wilkes & Elizabeth Theresa Wilkes, GPO Box P1214, Perth, WA	140.00	''	''
Nancy Dawn Wilkins & Craig Michael Westblade, 17 Varraford Avenue, Alphington	197.60	''	28/04/00
Nancy Dawn Wilkins, 17 Karraford Avenue, Alphington	120.70	''	''
Rachael Wilkinson & Calvin Wilkinson, 15 Candlebark Crescent, Chapel Hill, Qld	100.00	''	27/10/00
Thomas Wilkinson, 34 Spencer Road, Mosman, NSW	100.00	''	''
Simon Wilkinson, 7/2 Ranken Place, Belconnen, ACT	100.00	''	''
Robert Graeme Willersdorf, 9 Berkeley Street, Hawthorn	315.00	''	''
Fleuter William, 3 Altarnun Road, Langwarrin	100.00	''	''

Mr Dudley Leonard Williams, 1 Wallangra Road, Dover Heights, NSW	120.00	''	28/04/00
George Richard A. Williams, PO Box 3005, Liverpool, NSW	100.00	''	27/10/00
Alison Judith Williams, Barrabee RMD, Mountjoy Road, Moolap	185.45	''	28/04/00
Alison Judith Williams, Barrabee RMD, Mountjoy Road, Moolap	307.00	''	27/10/00
Kate Williams, 68 Bevan Street, Albert Park	100.00	''	''
Christopher Louis Williams, PO Box 10, Coffs Harbour, NSW	300.00	''	''
Damien Joseph Williams, 14 River Road, Camden, NSW	100.00	''	''
Paula Margaret Williams, 10/1 Cox's Lane, Lane Cove, NSW	164.25	''	28/04/00
Paula Margaret Williams, 10/1 Cox's Lane, Lane Cove, NSW	272.00	''	27/10/00
Linda Williams, 44 North Avoca Parade, North Avoca, NSW	100.00	''	''
Ms Marjorie Joan Williams, PO Box Q841, Queen Victoria Building, NSW	100.00	''	''
Mr Ernest James Williams, PO Box Q841, Queen Victoria Building, NSW	100.00	''	''
Iona Gwendoline Williams, PO Box 3781, Riverwood, NSW	160.00	''	28/04/00
Iona Gwendoline Williams, PO Box 3781, Riverwood, NSW	200.00	''	27/10/00
Carroll Anne Williams, "Benjamin Hopping A/c", PO Box 2172, Brighton North	120.70	''	28/04/00
Carroll Anne Williams, "Daniel Hopping A/c", PO Box 2172, Brighton North	160.00	''	''
Mark Annesley Williams, 2/11 Judge Street, Randwick, NSW	100.00	''	27/10/00
Eleanor P. Williams, 4 Charron Road, Croydon Park, SA	265.60	''	28/04/00
Eleanor P. Williams, 4 Charron Road, Croydon Park, SA	332.00	''	27/10/00
Mr Nick Williams, 42 Beaconsfield Parade, Albert Park	200.00	''	''
Mr Edward James Williams, Unit 8, 1 Parriwi Road, Mosman, NSW	100.00	''	''
John Williamson, Unit 3, 42 Meeks Street, Kingsford, NSW	100.00	''	''
Mr Scott Williamson, 14 Nelson Road, Katoomba, NSW	100.00	''	''
Ms Kirsty Williamson, 1/7 Maud Street, North Balwyn	100.00	''	''
Peter J Willington, 4 Newark Place, Connolly, WA	380.00	''	''
Bruce Willis, 5/148 Stafford Road, Brisbane, Qld	100.00	''	''
Mr Micheal James Willis, 107 Glenmore Road, Paddington, NSW	320.00	''	28/04/00
Mr Micheal James Willis, 107 Glenmore Road, Paddington, NSW	400.00	''	27/10/00
Katrina Willmott, "Tazanne Investment A/c", 2 Seena Place, Belrose, NSW	257.00	''	''
Clive R. Wilson, 26 Garrod Crescent, Stirling, SA	120.00	''	28/04/00
Clive R. Wilson, 26 Garrod Crescent, Stirling, SA	150.00	''	27/10/00
Donald Frame Wilson, 12A Lower Clifton Terrace, Red Hill, Qld	100.00	''	''
Jenny Wilson, 65 Sullivan Crescent, Wanniasa, ACT	100.00	''	''
Estate Neville Wilson, 1 Durdin Road, Hawthorn, SA	110.00	''	''
Stefan Wilson, 7 Gurney Road, Guildford, NSW	160.00	''	''
Felicity Wilson, Level 25, 225 George Street, Grosvenor Place, NSW	160.10	''	28/04/00
Felicity Wilson, Level 25, 225 George Street, Grosvenor Place, NSW	265.00	''	27/10/00

Anglie Wilson, Level 25, 225 George Street, Grosvenor Place, NSW	160.10	”	28/04/00
Anglie Wilson, Level 25, 225 George Street, Grosvenor Place, NSW	265.00	”	27/10/00
Andrew Wilson, 922 Burke Road, Balwyn	100.00	”	”
Mr James Wilson, 18 Avoca Street, South Yarra	260.00	”	”
David Wilson, Level 25, 225 George Street, Sydney, NSW	265.00	”	”
Mrs Debra Lynette Wilson, 33 Como Place, Ormiston, Qld	100.00	”	”
Nasreen Taj Wilson, 54 Grand Junction Rd, Rosewater, SA	100.00	”	”
Dr Nasreen Taj Dowling Wilson, “Farheen & Yasmin Dowling A/c”, 54 Grand Junction Road, Rosewater, SA	120.70	”	28/04/00
Dr Nasreen Taj Dowling Wilson, “Farheen & Yasmin Dowling A/c”, 54 Grand Junction Road, Rosewater, SA	200.00	”	27/10/00
Ms Angelina Wilson, 4/51 Kinkora Road, Hawthorn	217.60	”	28/04/00
Mr Peter Neil Wilson & Mrs Robyn Lynnette Wilson, Yarraman, Trangie, NSW	180.00	”	”
Gregory James Wilson, 79 Twilight, Kenmore, Qld	132.85	”	”
Gregory James Wilson, 79 Twilight, Kenmore, Qld	220.00	”	27/10/00
Andrew Michael Wilson, 23 Bell Street, Fitzroy	210.00	”	”
Andrew G. Wilson, 3 Sydney Street, Clayton South	148.00	”	28/04/00
Angelina Wilson, PO Box 381, Hawthorn	160.00	”	”
Mr John Augustine Wilson, 397 Tribune Street, Albury, NSW	162.00	”	”
Michael Wilson, 54/330 Wattle Street, Ultimo, NSW	300.00	”	27/10/00
Mr William Ian Wilson, 14/17 Como Avenue, South Yarra	176.00	”	28/04/00
B. Wilton, 1 Atherton Close, Aspendale	100.00	”	27/10/00
Winan Investments Pty Limited, C/-Powell Kwok & Co, Level 7, 350 Kent Street, Sydney, NSW	384.00	”	28/04/00
Winan Investments Pty Limited, C/-Powell Kwok & Co, Level 7, 350 Kent Street, Sydney, NSW	480.00	”	27/10/00
Winan Investments Pty Limited, Powell Kwok & Co, Suite 702 Level 7, 350 Kent Street, Sydney, NSW	100.00	”	”
Winan Investments Pty Ltd, C/-Powell Kwok & Co, Level 7, 350 Kent Street, Sydney, NSW	100.00	”	”
Scott Winders, 118 O’Sullivan Road, Leumeah, NSW	120.00	”	”
Charles Thomas Windeyer, 50 Golden Grove, Red Hill, ACT	111.00	”	”
Windlass House Pty Ltd, 27 Mason Street, Reservoir	150.00	”	”
Windsor Marketing Company Pty Ltd, PO Box 364, Hornsby, NSW	500.00	”	”
Olga Wirkerman & George Wirkerman, “Nicole Wirkerman A/c”, PO Box 123, Rosebery, NSW	217.20	”	28/04/00
Olga Wirkerman & George Wirkerman, ”Nicole Wirkerman A/c”, PO Box 123, Rosebery, NSW	360.00	”	27/10/00
George Wirkerman & Olga Wirkerman, “Laurence Wirkerman A/c”, PO Box 123, Rosebery, 4/49 Penkivile Street, Bondi, NSW	217.20	”	28/04/00

George Wirkerman & Olga Wirkerman, "Laurence Wirkerman A/c", PO Box 123, Rosebery, 4/49 Penkivile Street, Bondi, NSW	360.00	"	27/10/00
Ms Olga Wirkerman, PO Box 443, Mascot, NSW	217.20	"	28/04/00
Ms Olga Wirkerman, PO Box 443, Mascot, NSW	360.00	"	27/10/00
Mr George Wirkerman, PO Box 443 7 Kent Road, Mascot, NSW	217.20	"	28/04/00
Mr George Wirkerman, PO Box 443 7 Kent Road, Mascot, NSW	360.00	"	27/10/00
Daniel Paul Wise, 42 John Street, Cottesloe, WA	100.00	"	"
Kathryn Anna Wiseman, 31 Nickson St, Surry Hills, NSW	400.00	"	"
Andrew James Wiseman, 31 Nickson St, Surry Hills, NSW	241.45	"	28/04/00
Andrew James Wiseman, 31 Nickson St, Surry Hills, NSW	400.00	"	27/10/00
Celvin Lawry Withers, 6 MacArthur Ave, Pagewood, NSW	100.00	"	"
Eric A. Withers, 7 Allibone Street, Ashfield, NSW	240.00	"	28/04/00
Eric A Withers, 7 Allibone Street, Ashfield, NSW	300.00	"	27/10/00
Heath W. Withers, 64 Henry Parkes Drive, Berkeley Vale, NSW	250.00	"	"
Darryl Ross Wockner, 79 Bauman Way, Blackwater, Qld	160.00	"	"
Wolf Industries Aust Pty Ltd, PO Box 479, Rosebery, NSW	168.00	"	"
Wombat Nominees Pty Ltd, 1 Finey Street, Cottesloe, WA	222.40	"	28/04/00
Wombat Nominees Pty Ltd, 1 Finey Street, Cottesloe, WA	278.00	"	27/10/00
Robert Womersley, "Sunny Vale Pty Ltd A/c", Cnr Bannister Road & Sherman Street, Canning Vale, WA	112.00	"	28/04/00
Robert Womersley, "Sunny Vale Pty Ltd A/c", Cnr Bannister Rd & Sherman Street, Canning Vale, WA	140.00	"	27/10/00
Richard Wong & Doris Wong, 7 Vista Close, Kings Park, NSW	200.00	"	"
Lily Lin Wong, 8 Victoria Place, Paddington, NSW	141.40	"	"
Loke Cheong Wong, 818/28 Harbour Street, Sydney, NSW	232.00	"	28/04/00
Sek Yee Wong, 1102/97 Brompton Road, Kensington, NSW	112.00	"	"
Sek Yee Wong, 1102/97 Brompton Road, Kensington, NSW	140.00	"	27/10/00
Anne Shun-Hing Wong, 11 Dawson Court, Aspendale	120.00	"	28/04/00
Swee Khay Wong, 818/28 Harbour Street, Sydney, NSW	232.00	"	"
Kingsley Shung Lai Wong & Josephine Ty Chan, 24 Valencia Avenue, Churchlands, WA	100.00	"	27/10/00
Molly Wong, 12B/12 Bond Street, Hurstville, NSW	100.00	"	"
Judy Wong, PO Box 319, Milson Point, NSW	304.00	"	28/04/00
Judy Wong, PO Box 319, Milson Point, NSW	380.00	"	27/10/00
Alison Wong, 5 Magnolia, Stretton, Qld	100.00	"	"
Jennifer Man Yi Wong, 7/25 Maesbury St, Kensington, SA	120.70	"	28/04/00
Jennifer Man Yi Wong, 7/25 Maesbury St, Kensington, SA	200.00	"	27/10/00
Wai Tak Wong, 26 Carlos Road, Artarmon, NSW	100.00	"	"
Miss Fui Li Wong, 24 Peacock Street, Seaforth, NSW	100.00	"	"
Ms Keng I Wong, 2b Coronation Rd, Baulkham Hills, NSW	181.30	"	28/04/00
Mr Eric Wong, 13 Belah Avenue, Vacluse, NSW	100.00	"	27/10/00
Mr Tak Woo, Unit 82, 1 Serisier Avenue, Main Beach, Qld	100.00	"	"
Catherine Elaine Wood & Stephen James Wood, 257 Huntriss Road, Doubleview, WA	100.00	"	"
Gregory Orme Wood, 21/3B Bortfield Drive, Chiswick, NSW	100.00	"	"
Mr Gary Woodard & Mrs Janet Woodard, 41/30 Marine Parade, Southport, Qld	152.00	"	28/04/00
David Geoffrey Woodcock, 7 Newton Grove, Glen Waverley	378.00	"	27/10/00

Anne Lorraine Woodcock, 81 Frogmore Rd, Kidman Park, SA	100.00	''	''
Mr Rick Bradley Woods, 3 Cedar Rise, Warrandyte	308.00	''	''
Karen Margaret Woods, 3 Cedar Rise, Warrandyte	108.00	''	''
Martha Anne Woodsford & Mark William Woodsford, PO Box 489, Torquay	100.00	''	''
Damian Woodward & Jane Weiss, 65/47 Kennedy Street, Kingston, ACT	102.55	''	28/04/00
Damian Woodward & Jane Weiss, 65/47 Kennedy Street, Kingston, ACT	170.00	''	27/10/00
Allan Lee Woodward & Caroline Woodward, 496 Great Eastern Highway, Greenmount, WA	100.00	''	''
Martin Woollard, RMB 6299, Melville Forest, Via Coleraine	100.00	''	''
Chris J. Woolley & Alex P. Woolley, 32 Duncan Crescent, Collaroy Plateau, NSW	157.05	''	28/04/00
Ron Frank Woolley, 1/113 Eskdale Road, Caulfield	357.60	''	''
Ron Frank Woolley, 1/113 Eskdale Road, Caulfield	447.00	''	27/10/00
Gregory Woolley, 44 Kent Road, North Ryde, Nsw	296.00	''	28/04/00
Gregory Woolley, 44 Kent Road, North Ryde, Nsw	370.00	''	27/10/00
Christopher J Woolley, 2 San Angelo Road, Warrandyte	208.00	''	28/04/00
Word Magick Pty Ltd, 28 Wicklow Street, Ormond	100.00	''	27/10/00
Workable Solutions Pty Ltd, Unit 6, 65 Edgar Street North, Glen Iris	120.00	''	''
Worth Transport Pty Ltd, "Worth Retirement Fund", C/- Worth Recycling, 2/184 Cope Street, Waterloo, NSW	120.00	''	''
Yvonne Marion Worthington, 26 Lyndhurst Street, Richmond	120.00	''	''
Mr Peter Alexander Worthington, 26 Lyndhurst St, Richmond	120.00	''	''
Wr Esop Pty Ltd, "WA Exec Inc Plan (Foote) A/c", 1/14 Wilton Grove, Elwood	240.00	''	''
Sandra Ellen Wray, 7 Murphy Crescent, Coffs Harbour, NSW	100.00	''	''
Robert Wren, PO Box 86, School Road, Tungamah	202.00	''	''
Arthur Ivor Wright, Unit 1, 56 Abbot St, Cammeray, NSW	192.00	''	28/04/00
Walter Gurney Wright, 48/238 The Avenue, Parkville	100.00	''	27/10/00
Carol Wright, 295 Park Street, South Melbourne	128.00	''	28/04/00
Carol Wright, 295 Park Street, South Melbourne	160.00	''	27/10/00
Estate Walter Jeffery Wright, 48/238 The Avenue, Parkville	100.00	''	''
Anne Wright, 2/64 First Avenue, Mount Lawley, WA	120.70	''	28/04/00
Anne Wright, 2/64 First Avenue, Mount Lawley, WA	200.00	''	27/10/00
Alice Elizabeth Wright, 151 Ashburn Grove, Ashburton	100.00	''	''
Lorraine Wright, 9/4 Adelaide Street, West Ryde, NSW	176.00	''	28/04/00
Ian Wright, 697 Rathdowne Street, Carlton North	128.00	''	''
Mr Stephen T. Wright, Level 29, 101 Miller Street, North Sydney, NSW	315.50	''	27/10/00
Mr Gregory John Wrobel, 34 Douglas St, Merrylands, NSW	130.00	''	''
Fang Min Wu & Jun Zhu, 70 Antoine St, Rydalmere, NSW	197.60	''	28/04/00
Ngoc Wu, 15a Inkerman Street, Mossman, NSW	217.60	''	''
Stephen Wu, 1/23 Gardener Avenue, Ryde, NSW	100.00	''	27/10/00
Lie Lie Wu, 1/23 Gardener Avenue, Ryde, NSW	100.00	''	''
Mrs Jenny Wu, "Emily's Education Account", 100 New Canterbury Road, Petersham, NSW	100.00	''	''
Chia-Jung Wu, 12-6 Lal-Kan Liaoi, Hai-Cheng Li, Chia Li Tainan, Taiwan (722) Roc	100.00	''	''
Mr Zai Hoi Wu, Unit 70, 129 Park Road, Dundas, NSW	150.00	''	''

Est Lesley Elizabeth Wudy, C/- P. H. & T. Wudy, 522 Henry Lawson Drive, East Hills, NSW	120.00	''	''
Maya Wuethrich, 3 Calgaroo Avenue, Muswellbrook, NSW	120.00	''	''
Raymond Karl Wurlod, PO Box 1214, North Sydney, NSW	100.00	''	''
Rylie James Wyld, RMB 4081, Boyles Road, Longford	100.00	''	''
Gregory John Wyllie, PO Box 10, Camden, NSW	100.00	''	''
Xin Xiao, 333/422 Pitt Street, Sydney, NSW	100.00	''	''
Ming Xie & Xiao Fang Yu, 3/11 Station Street, Blackburn	140.00	''	''
Ju Shan Xie, Unit 18/432-434 Railway Parade, Allawah, NSW	110.00	''	''
Wei Xiong Xu, PO Box 230, Wentworthville, NSW	100.00	''	''
Miss Paula Amy Yagmich, Lot 188, Old Toodyay Road, Red Hill, WA	100.00	''	''
Miss Rebecca Megan Yagmich, Lot 188, Old Toodyay Road, Red Hill, WA	100.00	''	''
Mrs Patricia Margaret Yagmich, Lot 188, Old Toodyay Road, Red Hill, WA	100.00	''	''
Andrew Yamouni, 43 Manningham Road, Bulleen	120.00	''	28/04/00
Darwin Yan, 1 Captain Arthur Phillip Road, Terrigal, NSW	416.00	''	27/10/00
Eliza Shuk Ching Yan, 4 Aspen Avenue, Terrigal, NSW	120.00	''	''
Kenneth Jian-Quan Yan & Li-Fang Liao, "Zi-Jun Yan A/c", 5/28 Rutland Street, Allawah, NSW	120.00	''	''
Mr Edward Yan, 11 Newlands Avenue, Terrigal, NSW	120.00	''	''
Zheng Yan, 3/27 Crawford Street, Berala, NSW	104.00	''	''
Paul Xu-Bo Yang, 38 Dalley Street, Queenscliff, NSW	160.00	''	28/04/00
Miss Hui Yang, 93/392 Jones Street, Ultimo, NSW	120.70	''	''
Miss Hui Yang, 93/392 Jones Street, Ultimo, NSW	200.00	''	27/10/00
Miss Bing Yao, 10 Woodhouse Grove, Box Hill North	120.00	''	''
Mr Zhijie Yao, 10 Woodhouse Grove, Box Hill North	120.00	''	''
Jimmy Yap & Thi Cam Loan Ly, PO Box 560, Cabramatta, 7 Latham Place, Canley Vale, NSW	200.00	''	''
Mr Poh Wan Yap, 1129 Whitehorse Road, Box Hill	100.00	''	''
Judith Winifred Yates, 16 Bird Court, Williamstown	140.00	''	''
Cheryl Pauline Ann Yates, 1/3 Cowdroy Ave, Cammeray, NSW	140.00	''	''
Tin Tat Yau, 12 Undine Street, Russell Lea, NSW	126.75	''	28/04/00
Tin Tat Yau, 12 Undine Street, Russell Lea, NSW	210.00	''	27/10/00
Simon Alistair Yeats, 2/31 Kensington Rd, South Yarra	105.00	''	''
Robert Yeghi, G121/780 Bourke St, Redfern East, NSW	160.00	''	''
Sandra Au Yeung, Level 6, 60 Margaret St, Sydney, NSW	100.00	''	''
Mrs Yang Jun Yi, Unit 17, 10 Anderson Road, Thornbury	100.00	''	''
Ms Li Yi & Mr Hao Li, 642 Springvale Road, Mulgrave	150.00	''	''
Yiangos Yiangos, 88 Greenacre Road, Greenacre, NSW	250.00	''	''
Tin Fook Yim, 32 Marguerette Street, Ermington, NSW	100.00	''	''
Mr Guo Hua Yin, 1 Simmons Road, Kingsgrove, NSW	129.80	''	28/04/00
Dai Hua Ying & Xu Fang, 8/9-11 Innes Road, Manly Vale, NSW	128.00	''	27/10/00
Ms Vivian Mary Hang Phui Yip, Unit 2-6, 2 Cardigan Lane, Camperdown, NSW	450.00	''	''
Lee Hooi Yock, 18 Monomeath Close, Doncaster East	100.00	''	''
Choon Gil Yoon, 4/83 Dalmeny Avenue, Rosebery, NSW	257.00	''	''
Matthew Yoong, Unit 5, 136 Oxlade Drive, New Farm, Qld	120.00	''	''
Timothy Gerard Yore & Luke Brian Yore & Daniel Joseph Yore, Fleetwood Street, Aramac, Qld	120.00	''	''

Yorkell Pty Ltd, 27 Stanley Street, Richmond	150.00	''	''
Francis Joseph Young, 30 Victoria Ave, Concord West, NSW	100.00	''	''
Phillip Young, 60 Summerhill Road, Glen Iris	169.20	''	28/04/00
Phillip Young, 60 Summerhill Road, Glen Iris	280.00	''	27/10/00
Rodney Lewis Young, PO Box 5152, Mordialloc	181.30	''	28/04/00
Rodney Lewis Young, PO Box 5152, Mordialloc	300.00	''	27/10/00
Robert John Young, PO Box 317, Flemington	120.00	''	''
Andrew P. Young, 60 Grange Road, Sandringham	140.60	''	''
Mr Clinton Brian Youngson, Unit 1, 2 Quarry Road, Ryde, NSW	556.00	''	28/04/00
Mr Clinton Brian Youngson, Unit 1, 2 Quarry Road, Ryde, NSW	260.00	''	27/10/00
Mr Colin George Youren & Mrs Elizabeth Ann Youren, "Youren Super Fund A/c", Unit 1/1 St Georges Rd, Toorak	500.00	''	''
Dr Chee Keung Yu, 4 Elouera Crescent, Moorebank, NSW	228.00	''	''
Miss Katharine Madeleine Yuill, 17 Lloyd Avenue, Hunters Hill, NSW	460.00	''	''
Christina Zadkovich, 99 The Strand, Bedford, WA	110.00	''	''
Mr Victor Zagame, 13 Pearson Street, Brighton	210.00	''	''
Kerry Zalmstra & Olaf Zalmstra, 6 Park Road, Aspendale	100.00	''	''
Jane Zammit, 600 East Kurrajong Rd, East Kurrajong, NSW	100.00	''	''
Guk Jui Zan, PO Box 209, Sydney University, NSW	201.73	''	28/04/00
Guk Jui Zan, PO Box 209, Sydney University, NSW	334.60	''	27/10/00
Gordon J. Zanker, 34 Trimmer Parade, Woodville West, SA	125.00	''	''
Zantran Pty Ltd, 46 Annandale Street, Annandale, NSW	224.35	''	28/04/00
Zantran Pty Ltd, 46 Annandale Street, Annandale, NSW	372.00	''	27/10/00
Ines Zarate & George Zarate, 59 Seventh Avenue, Campsie, NSW	120.70	''	28/04/00
Mr John Zarich, 11F 36-42 Princess Street, Brighton-Le-Sands, NSW	128.00	''	27/10/00
Mrs Ruza Zarich, 11F 36-42 Princess Street, Brighton-Le-Sands, NSW	128.00	''	''
Valentine Zavier, 83/219 Chalmers Street, Redfern, NSW	110.00	''	''
Mrs Min Lam Zee, 72A Radnor Street, Camberwell	640.00	''	28/04/00
Mrs Min Lam Zee, 72A Radnor Street, Camberwell	800.00	''	27/10/00
Mr Peter Zeilic, PO Box 2227, Clovelly, NSW	120.70	''	28/04/00
Mr Peter Zeilic, PO Box 2227, Clovelly, NSW	200.00	''	27/10/00
Gerhard Zelenka, 5 Pindari Street, Glen Waverly	110.00	''	''
Mr Jacky Lehua Zeng, Unit 101, 8 Water Street, Birchgrove, NSW	160.00	''	28/04/00
Daxu Zhan, "William Zhan A/c", 11/116 Balaclava Road, Eastwood, NSW	100.00	''	27/10/00
Qin Sen Zhang & Nen Liang Qin, "Queena Yan Qin Account", 4 Bella Court, Doncaster East	100.00	''	''
Nei Zhang, 7/120 Rankins Road, Kensington	132.85	''	28/04/00
Wei-Zhong Zhang & Li-Ying Zhu, 11 Jolimont Avenue, Mulgrave	104.00	''	27/10/00
Mrs Dong Mei Zhang, 26 Barellan Avenue, Carlingford, NSW	100.00	''	''
Mr Ming Zhang, 104 Correys Avenue, Concord, NSW	104.00	''	''
Ms Mao Ying Zhang, Rm# 1301/20, 1030 Rong Yan An West Road, Shanghai, China	603.10	''	28/04/00
Wen Jing Zhao, 11/13 St Georges Parade, Hurstville, NSW	100.00	''	27/10/00
Yu Ting Zhao, "Gain Sun Pty Ltd A/c",			

14/25 King Edward Street, Rockdale, NSW	100.00	''	''
Ms Jia Zhao & Ms Liming Yin,			
9/37 Harrington Street, Marrickville, NSW	120.00	''	''
Zhu Yuan Zheng, 10/23 Rosemont Street, Punchbowl, NSW	120.00	''	''
Ms Hui Bao Zheng, PO Box 818, Surfers Paradise, Qld	120.70	''	28/04/00
Simon Yong Wen Zhong, 3/90 Arthur Street, Rosehill, NSW	192.95	''	''
Simon Yong Wen Zhong, 3/90 Arthur Street, Rosehill, NSW	320.00	''	27/10/00
Mr Ming Guang Zhong, 9/28 Meredith St, Bankstown, NSW	508.00	''	''
Mr Hao Zhou, 51 Pitt Road, North Curl Curl, NSW	128.00	''	28/04/00
Mr Hao Zhou, 51 Pitt Road, North Curl Curl, NSW	160.00	''	27/10/00
Mr Gang Rong Zhu, PO Box 152, Echuca	420.00	''	''
Abdullah Zia-Popal, 2/2 The Close, Hunters Hill, NSW	176.00	''	28/04/00
Jennifer Zietz, 41 Tobruk Avenue, St Marys, SA	100.00	''	27/10/00
Zig Zag Superannuation Fund, "Kha Ruey A/c",			
36 Parker Street, Templestowe	212.00	''	''
Anthony Zita, 462 Queens Pde, Clifton Hill	100.00	''	''
John Edward Zorzi, 18 Spinkbrae St, Fig Tree Pocket, Qld	256.00	''	28/04/00
John Edward Zorzi, 18 Spinkbrae St, Fig Tree Pocket, Qld	320.00	''	27/10/00
Ghaith Zraiqat, 121 Ray Road, Epping, NSW	510.00	''	''
Marcel Zufferey, PO Box 119 Crown St, Darlinghurst, NSW	169.60	''	28/04/00
Marcel Zufferey, PO Box 119 Crown St, Darlinghurst, NSW	212.00	''	27/10/00
Zullu Holdings Pty Ltd, Po Box 10, Wilston, Qld	107.20	''	''
John Boleslaw Zurakowski & Anna Nicola Zurakowski			
Unit 1/9 Hopgood Place, Barwon Heads	212.00	''	28/04/00
Zurich Bay Holdings Pty Ltd, PO Box 868, Cloverdale, WA	603.10	''	''
Zurich Bay Holdings Pty Ltd,			
39/43 Murray Road, Welshpool, WA	800.00	''	''
Zurick Bay Holdings Pty Ltd, PO Box 868, Cloverdale, WA	301.55	''	''

02146

CONTACT: TELSTRA SHARE REGISTRY ASX PERPETUAL REGISTRARS LIMITED,
PHONE: 1800 060 608.

PROCLAMATIONS

Land Act 1958

PROCLAMATION OF ROAD

I, John Landy, Governor of Victoria with the advice of the Executive Council and under section 25(3)(c) of the **Land Act 1958** proclaim as road the following land:

MUNICIPAL DISTRICT OF THE MITCHELL SHIRE COUNCIL

BROADFORD — The land in the Township of Broadford, Parish of Broadford being Crown Allotment 2001 shown by hatching on plan hereunder. (GP1044) — (L7-0874).

Given under my hand and the seal of Victoria on 6th August 2002.

(L.S.) **JOHN LANDY**
Governor

By His Excellency's Command

ANDRÉ HAERMEYER
Minister for Corrections

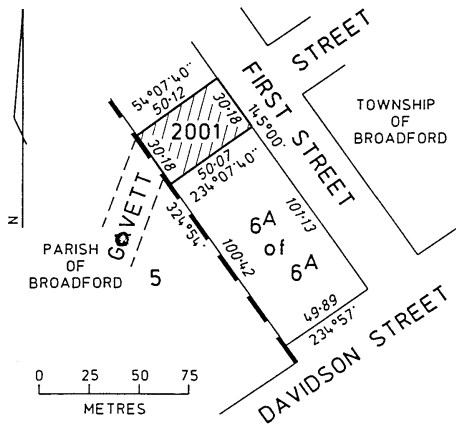

This Proclamation is effective from the date on which it is published in the Government Gazette.

Given under my hand and the seal of Victoria on 6th day of August 2002.

(L.S.) **JOHN LANDY**
Governor

By His Excellency's Command

SHERRYL GARBUTT MP
Minister for Environment
and Conservation

International Transfer of Prisoners (Victoria) Act 1998

PROCLAMATION OF COMMENCEMENT

I, John Landy, Governor of Victoria, with the advice of the Executive Council and under section 2 of the **International Transfer of Prisoners (Victoria) Act 1998**, fix 8 August 2002 as the day on which the remaining provisions of that Act come into operation.

**GOVERNMENT AND OUTER BUDGET SECTOR AGENCIES
NOTICES**

STONNINGTON CITY COUNCIL

Road Discontinuance

At its meeting on 23 July 2002 and acting under clause 3 of schedule 10 to the **Local Government Act 1989**, Stonnington City Council resolved to discontinue the road shown as lots 1 & 2 on the plan below.

The road is to be sold subject to any right, power or interest held by Stonnington City Council and Yarra Valley Water, as to the land marked "E-1", in the road in connection with any sewers, drains or pipes under the control of those authorities in or near the road.

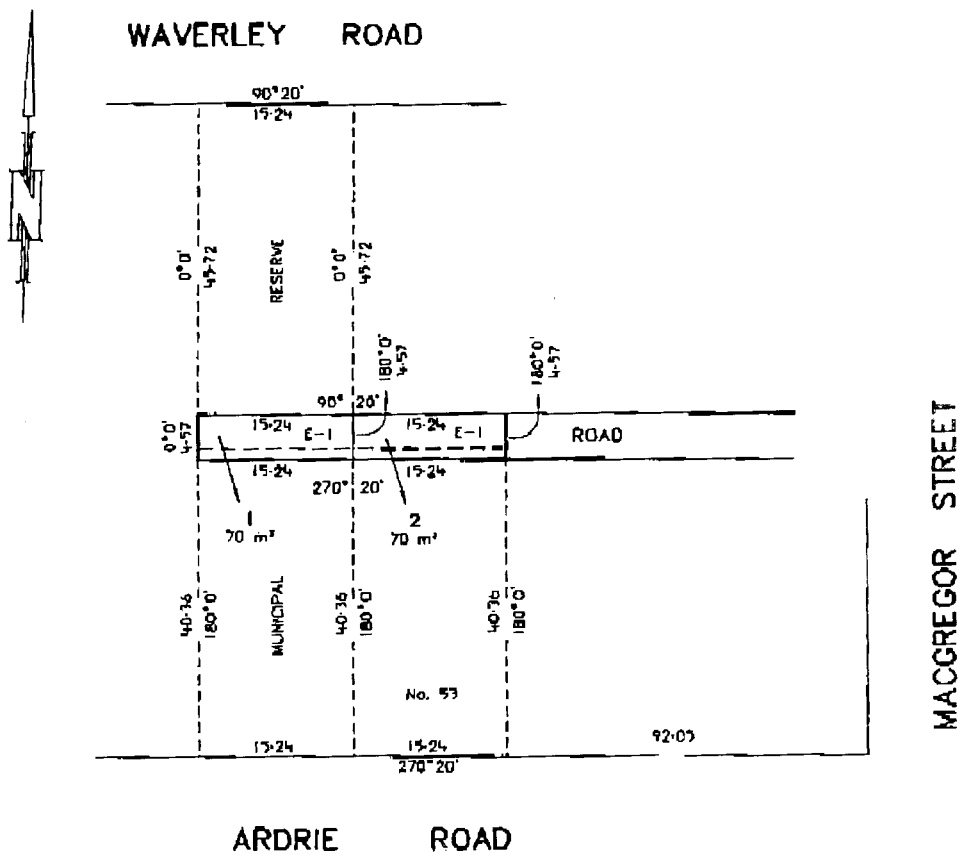

MR HADLEY SIDES
Chief Executive Officer

SURF COAST SHIRE

Declaration of Public Highways.

In accordance with Section 204 of the **Local Government Act 1989** the Surf Coast Shire Council at its meeting held on the 16 April 2002 resolved that the unnamed laneways highlighted on the plans below be declared as public highways.

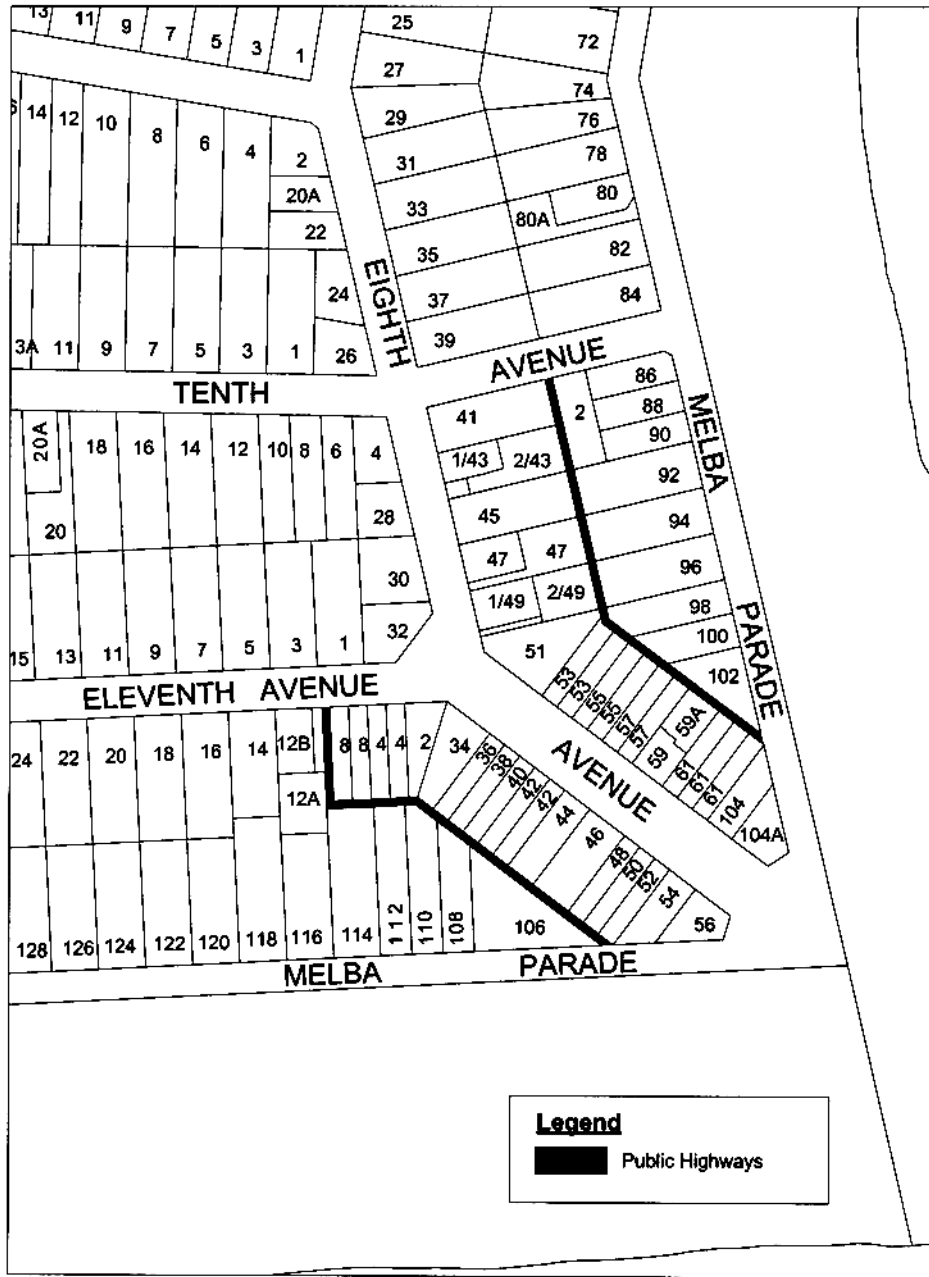

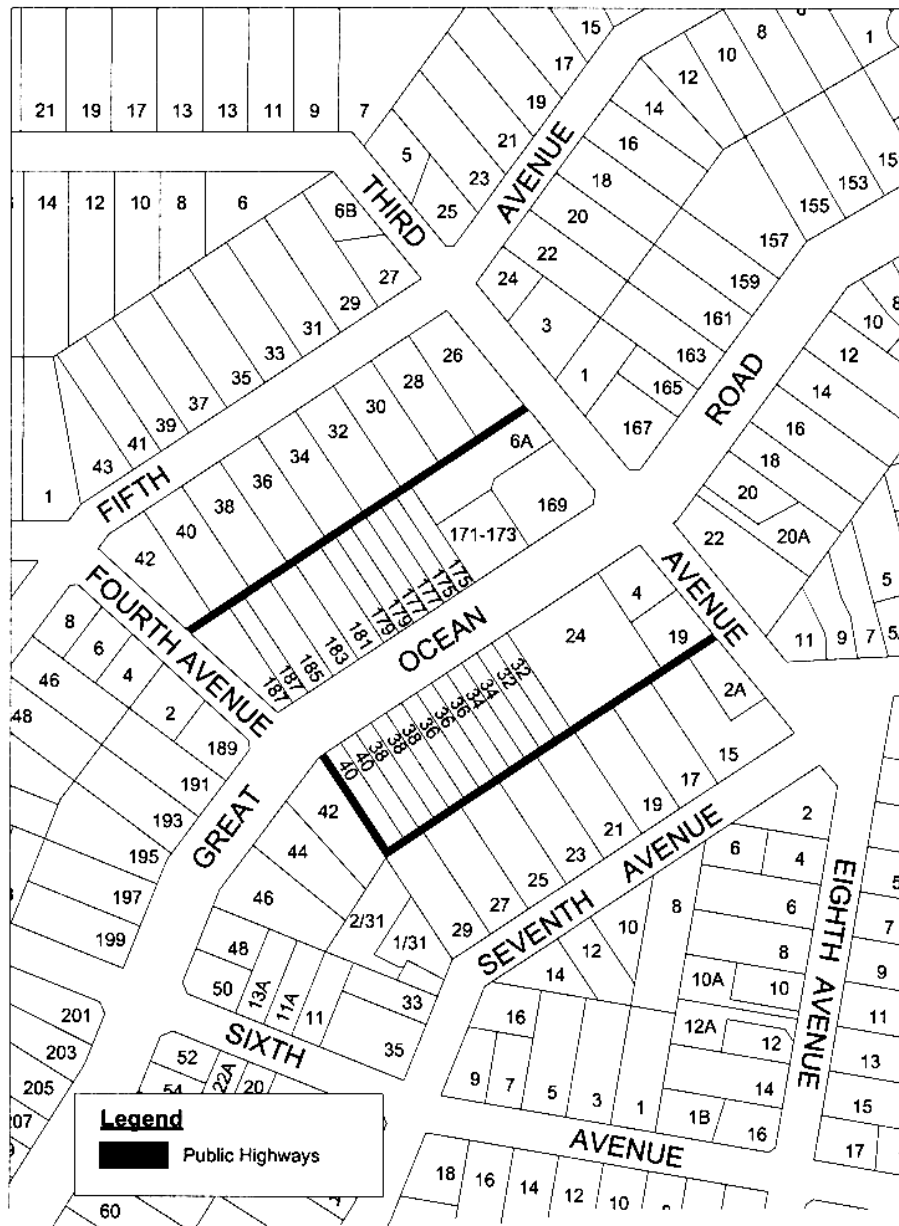

MICHAEL ULBRICK
Acting Chief Executive Officer.

CITY OF MELBOURNE

Public Highway Declaration

Under Section 204 (1) of the **Local Government Act 1989** (“the Act”), Melbourne City Council, on 30 July 2001 resolved to declare Aplin Place (Corporation Lane No. 1630), Carlton as a Public Highway for the purposes of the Act as shown on the plan hereunder.

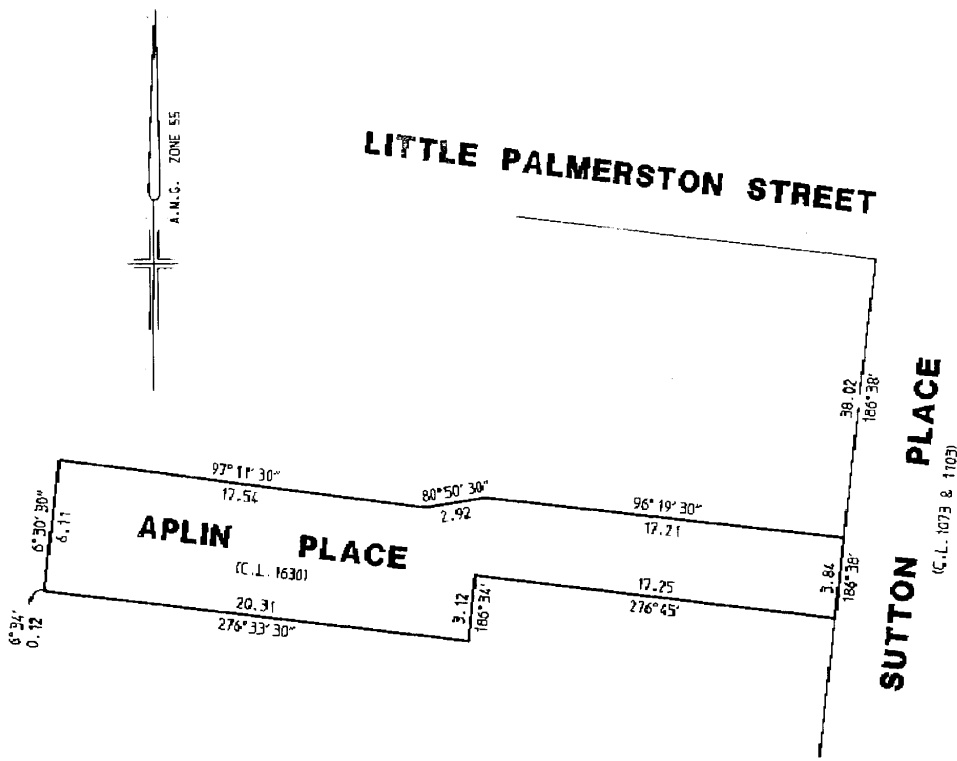

Dated 8 August 2002

MICHAEL MALOUF
Chief Executive Officer

PORT PHILLIP CITY COUNCIL
Community Amenity (Amendment)
Local Law No. 2 of 2002

Port Phillip City Council (Council) gives notice that at its meeting on 22 July 2002, it adopted Community Amenity (Amendment) Local Law No. 2 of 2002 (“the amending Local Law”).

The amending Local Law changes the Community Amenity Local Law No. 1 (the Principal Local Law) in order to better meet the local amenity and safety objectives of the Principal Local Law by managing, regulating and controlling uses and activities which may:

- be dangerous, cause a nuisance or be detrimental to the amenity of the area or to the environment; and
- interfere with a healthy and safe environment in the municipal district for residents, workers and visitors.

The general purport of the amending Local Law is to amend clause 24(5) of the Principal Local Law, by delaying the period in which building works may be carried out on building sites on Saturdays. The period will change from “7.00 a.m. to 1.00 p.m.”, to “9.00 a.m., to 3.00 p.m.” on Saturdays. It is an offence to carry out building works outside this period without first obtaining a permit from Council.

The Local Law will commence on 15 August 2002. However, it will not apply to building works where an application for a building permit has been made prior to 15 August 2002, or where a builder provides evidence to the satisfaction of Council that the builder has entered into contracts

for the building works prior to 15 August 2002 on the basis of the Principal Local Law in its unamended form.

In addition the Council has modified the Procedures and Protocols Manual so as to address the changes to the Principal Local Law. In particular the modifications relate to the matters for consideration in determining whether to grant a permit for out of hours work and the permit conditions to be included in such permits.

A copy of the amending Local Law and Procedures and Protocols Manual may be inspected at or obtained from the Council offices at the corner of Carlisle Street and Brighton Road, St. Kilda; Port Melbourne Town Hall, Bay Street, Port Melbourne and South Melbourne Town Hall, Bank Street, South Melbourne. Office hours are generally 8.30 a.m. to 5.00 p.m. Monday to Friday or by viewing Councils website at www.portphillip.vic.gov.au

DAVID SPOKES
Chief Executive Officer



**GENERAL AMENDMENT
LOCAL LAW 2002**

Notice is hereby given that at its Ordinary Meeting of 22 July 2002, Melton Shire Council made the Local Law titled "General Amendment Local Law 2002".

The purpose of General Amendment Local Law 2002 is to amend Local Law No. 1 to include provisions for objection and appeal to notices served in accordance with Clauses 522, 524A, 706 and 810 of Local Law No. 1. These clauses relate to provisions in Local Law No. 1 dealing with "overhanging branches", "building works", "unsightly and dangerous premises" and "noise and smell".

The General Amendment Local Law 2002 came into operation from 22 July 2002.

A copy of General Amendment Local Law 2002 can be inspected at the Civic Centre, 232 High Street, Melton during business hours.

NEVILLE SMITH
Chief Executive



**AMENDMENT (MEETING PROCEDURE)
LOCAL LAW 2002**

Notice is hereby given that at its Ordinary Meeting of 24 June 2002, Melton Shire Council made the Local Law titled "Amendment (Meeting Procedure) Local Law 2002".

The purpose of Amendment (Meeting Procedure) Local Law 2002 is to amend Local Law No. 2 (2001) by amending Clause 20.1 to include the reading of the opening paragraph of the Melton Shire Council Reconciliation Statement adopted by Council on 4 February 2002.

The Amendment (Meeting Procedure) Local Law 2002 came into operation from 24 June 2002.

A copy of Amendment (Meeting Procedure) Local Law 2002 can be inspected at the Civic Centre, 232 High Street, Melton during business hours.

NEVILLE SMITH
Chief Executive

**Planning and Environment Act 1987
BALLARAT PLANNING SCHEME**

**Notice of Amendment
Amendment No. C59**

The City of Ballarat has prepared Amendment No. C59 to the Ballarat Planning Scheme.

The Amendment proposes to rezone land at 921-927 Barkly Street, Mount Pleasant from Industrial 1 Zone to Residential 1 Zone.

The Amendment can be inspected at any of the following locations:- City of Ballarat, Watershed Office, (Grenville Street South, Ballarat); Department of Infrastructure, Western Region Office, 88 Learmonth Road, Wendouree and Department of Infrastructure, Nauru House, 80 Collins Street, Melbourne.

Submissions about the Amendment must be sent to the Chief Executive Officer, City of Ballarat, PO Box 655, Ballarat, Vic. 3353, and will be accepted until 5.00 p.m. Monday 9 September 2002. All submissions should clearly

state all of the grounds on which you support or oppose the Amendment and indicate whether you wish to be heard in respect of the submission at any subsequent panel hearing.

HEATH MARTIN
Senior Strategic Planner

Planning and Environment Act 1987

BAYSIDE PLANNING SCHEME

Notice of Amendment

Amendment C25

The City of Bayside has prepared Amendment C25 to the Bayside Planning Scheme.

Land affected by the Amendment: All land within the City of Bayside affected by the Design and Development Overlay–Schedule 1–Coastal Environs, shown as DDO1 on the planning scheme maps, is affected by this amendment.

The Amendment proposes to change the Bayside Planning Scheme by amending the Design and Development Overlay–Schedule 1–Coastal Environs to prohibit roof decks on all affected land within the City of Bayside.

A copy of the Amendment can be inspected, free of charge, during office hours, at: Department of Infrastructure, Planning Information Centre, Upper Plaza, Nauru House, 80 Collins Street, Melbourne, Vic. 3000; Department of Infrastructure, South East Metropolitan Office, 12 Lakeside Drive, East Burwood, Vic. 3153; Bayside City Council, Corporate Centre, Royal Avenue, Sandringham, Vic. 3191; Brighton Library, 14 Wilson Street, Brighton, Vic. 3186; Sandringham Library, Waltham Street, Sandringham, Vic. 3191; Beaumauris Library, Reserve Road, Beaumaris, Vic. 3193 and Hampton Library, Service Street, Hampton, Vic. 3188.

A full copy of the Amendment can be viewed on Council's website at www.bayside.vic.gov.au

Submissions about the Amendment must be in writing and be sent to: Chief Executive Officer, Bayside City Council, PO Box 27, Sandringham, Vic. 3191.

Submissions may support, oppose or make comment about any element of the proposed Amendment. Submissions should include your name and address.

Submissions to this Amendment should be received by Friday 6 September 2002.

IAN WILSON
Chief Executive

Planning and Environment Act 1987

MOIRA PLANNING SCHEME

Notice of Amendment

Amendment C13

Moira Shire Council has prepared Amendment C13 to the Moira Planning Scheme. The Amendment affects land in all areas of the municipality. The Amendment implements the recommendations of the recently completed “Three Year Review” of the performance of the Moira Planning Scheme since 1999.

The Amendment proposes to:

- replace the Municipal Strategic Statement with a completely new Municipal Strategic Statement;
- replace the Local Planning Policies with a completely new suite of local policies;
- rezone various parcels of the land throughout the municipality as a result of Strategic work, correcting anomalies or site specific issues;
- alter various areas affected by overlays;
- replace or alter several schedules to zones, overlays, particular provisions and general provisions;
- delete an incorporated document from the scheme.

The Amendment, explanatory report and accompanying documentation can be inspected, free of charge, during office hours at: Moira Shire Council, 44 Station Street, Cobram 3644; Department of Infrastructure, North Eastern Region, 50–52 Clarke Street, Benalla 3672; Department of Infrastructure, Customer Service Centre, Upper Plaza, Nauru House, 80 Collins Street, Melbourne and Moira Shire Council web site at: <http://www.moira.vic.gov.au>

Any submissions about the Amendment must be in writing and sent to: Michael Byrne, General Manager Engineering and Development, Moira Shire Council, P.O. Box 578, Cobram 3644.

The closing date for submissions is 8 October 2002.

Planning and Environment Act 1987

GREATER GEELONG PLANNING SCHEME

Notice of Amendment

Amendment C11

The City of Greater Geelong has prepared Amendment C11 to the Greater Geelong Planning Scheme.

The Amendment proposes to amend the Greater Geelong Planning Scheme by inserting a new Schedule to the Business 1 zone which increases the maximum retail floorspace of the Town and Country Shopping World at the corner of Princes Highway and Pioneer Road, Grovedale by 6,000 sq metres from 15,000 sq metres to 21,000 sq metres.

The Amendment can be inspected at City of Greater Geelong, Customer Service Centre, 131 Myers Street, Geelong; Department of Infrastructure, Office of Planning, 180 Fyans Street, South Geelong 3220 and Department of Infrastructure, Level 3 Plaza, Nauru House, 80 Collins Street, Melbourne 3000.

Submissions about the Amendment must be sent to the Planning Scheme Unit, City of Greater Geelong, PO Box 104, Geelong 3220, by Monday 9 September 2002.

IAN McCARTNEY
Co-ordinator Strategic Planning

Planning and Environment Act 1987

GREATER SHEPPARTON PLANNING SCHEME

Notice of Amendment

Amendment C25

Habitat Planning, Environmental and Development Consultants in Albury–Wodonga has prepared Amendment C25 to the Greater Shepparton Planning Scheme.

The Amendment affects land within and adjacent to the Hilltop Golf and Country Club in Tatura. The Amendment proposes to:

- rezone that part of the subject land currently zoned Rural (RUZ) to Residential 1 (R1Z);
- apply the Development Plan Overlay and associated Schedule 2 (DPO2) to the existing golf course and associated facilities (Lots 1 & 2 in LP 66677); and
- replace the existing Schedule 1 to the Development Plan Overlay on land to the north of the golf course (Lot 1 in PS 429159U) with Schedule 2.

The Amendment is available for public inspection, free of charge, during office hours at City of Greater Shepparton, 90 Welsford Street, Shepparton and the Council Service Centre, Casey Street, Tatura and Department of Infrastructure, Regional Office, 50–52 Clarke Street, Benalla and Department of Infrastructure, Customer Service Centre, Upper Plaza, Nauru House, 80 Collins Street, Melbourne.

Submissions about the Amendment must be sent to Manager Planning, City of Greater Shepparton, Locked Bag 1000, Shepparton 3632, by Monday 9 September 2002.

Dated 23 July 2002

COLIN KALMS
Manager Planning

Planning and Environment Act 1987

PORT PHILLIP PLANNING SCHEME

Notice of Amendment

Amendment C35

The Port Phillip City Council has prepared Amendment C35 to the Port Phillip Planning Scheme.

The Amendment affects the land at 60 and 64 Fitzroy Street, St Kilda and is known as the former St Kilda Railway Station and Caltex Service Station sites.

The Amendment proposes to change the local provisions of the Port Phillip Planning Scheme by rewording Section 5.0 of Schedule 2 to the Comprehensive Development Zone so the advertising controls as applying to part of the affected site are in Category 3 of the table to

Clause 52.05. The remainder of the site will remain in a Category 4 advertising control.

Currently advertising signs on the subject site require a planning permit and cannot exceed 3 square metres per premises. The Amendment would allow the retail and commercial premises on the site to apply for a planning permit for business identification signs in excess of 3 square metres.

A copy of the Amendment can be inspected, free of charge, during office hours at: City of Port Phillip Municipal Offices, South Melbourne Town Hall, 208–220 Bark Street, South Melbourne 3205; Department of Infrastructure, Planning Information Centre, Upper Plaza, Nauru House, 80 Collins Street, Melbourne 3000 or St Kilda Town Hall – Reception, corner Carlisle Street and Brighton Road, St Kilda 3182.

Submissions about the Amendment must be sent to: Yvonne Rust, Team Leader, Strategic Planning, City of Port Phillip, Private Bag No. 3, PO St Kilda, Victoria 3182 by 5.00 p.m. on 9 September 2002.

DAVID SPOKES
Chief Executive Officer



Planning and Environment Act 1987
GOLDEN PLAINS PLANNING SCHEME
Notice of Amendment
Amendment C12

Golden Plains Shire has prepared Amendment C12 to the Golden Plains Planning Scheme.

The Amendment applies to land at Bannockburn. In particular the Amendment applies to:

- Crown Allotment 15, Section 22B, Bruce Street, Bannockburn;
- Lots 1 and 2, PS 449155, Bruce Street, Bannockburn (previously Crown Allotment 13, Section 22B).

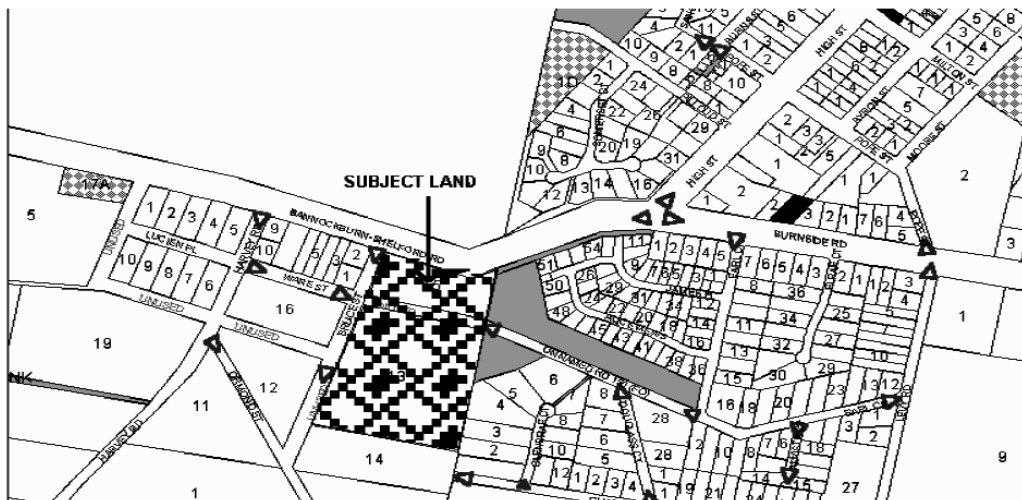

The Amendment proposes to:

1. Change the zoning of the above land from Rural Zone to Township Zone.

The Amendment and accompanying supporting material is available for inspection free of charge during office hours at the following places: Golden Plains Shire, Customer Service Centre – Bannockburn, 2 Pope Street, Bannockburn; Department of Infrastructure, Barwon/South Western Regional Office, 180 Fyans Street, South Geelong and Department of Infrastructure, Customer Service Centre, Upper Plaza, Nauru House, 80 Collins Street, Melbourne.

Submissions about the Amendment must be received no later than 5.00 pm on 9 September 2002 to: The Chief Executive Officer, Golden Plains Shire, PO Box 111, Bannockburn 3331.

ROD NICHOLLS
Chief Executive Officer

Creditors, next-of-kin and others having claims against the estate of any of the undermentioned deceased persons are required to send particulars of their claims to State Trustees Limited, ACN 064 593 148, 168 Exhibition Street, Melbourne, Victoria 3000, the personal representative, on or before 8 October 2002 after which date State Trustees Limited may convey or distribute the assets having regard only to the claims of which State Trustees Limited then has notice.

ATKINS, Howard Ernest, late of 228 Ballarat Road, Footscray, who died 26 September 2002.

GILMOUR, Doris Alberta, late of 13 Lewis Road, Wantirna, who died 28 May 2002.

HALE, Alec Bert, late of Yarraville Village, Somerville Road, Yarraville, retired, who died 19 May 2002.

MORCOM, Frederick Lonsdale, formerly of 1 Kingsley Road, Reservoir, late of Ashley Terrace Hostel, 17–21 Ashley Street, Reservoir, retired, who died 20 July 2002.

PASCOE, Emma Frances, late of 106 Thomas Street, Hampton, retired, who died 9 July 2002.

PEARCE, Joyce, late of Unit 1, 24 East Street, Daylesford, pensioner, who died 18 April 2002.

SCHUTT, Agnes Cecilia, late of Taylor Lodge Nursing Home, 2–6 Copernicus Way, Keilor Downs, retired, who died 1 May 2002.

SHEVENAN, Ethel May, late of 4 Ferndale Road, Glen Iris, home duties, who died 19 May 2002.

Dated at Melbourne, 30 July 2002

LAURIE TAYLOR
Manager, Estate Management
State Trustees Limited

Creditors, next-of-kin and others having claims against the estate of any of the undermentioned deceased persons are required to send particulars of their claims to State Trustees Limited, ACN 064 593 148, 168 Exhibition Street, Melbourne, Victoria 3000, the personal representative, on or before 14 October 2002 after which date State Trustees Limited may convey or distribute the assets having regard only to the claims of which State Trustees Limited then has notice.

CECIL, Robert John, late of 76 Townsend Street, Welshpool, retired, who died 11 June 2002.

DICKSON, Ronald George, late of 13 Empress Road, St. Kilda East, who died 17 May 2002.

HAYWOOD, Joan, late of Eastern Districts Nursing Home, 122–124 Maroondah Highway, Croydon, who died 3 June 2002.

LONG, Arthur Rupert James, late of 7 Porter Street, Hampton, who died 2 July 2002.

MANGA, George, late of Flat 20, 53 De Carle Street, Brunswick, retired, who died 27 April 2002.

RAKI, Boris, late of Sheraton Private Nursing Home, 347 Nepean Highway, Frankston, who died 14 June 2002.

WEIR, Vivienne Winifred, late of 20 Booth Street, Parkdale, who died 21 May 2002.

Dated at Melbourne, 5 August 2002

LAURIE TAYLOR
Manager, Estate Management
State Trustees Limited

Creditors, next-of-kin and others having claims against the estate of any of the undermentioned deceased persons are required to send particulars of their claims to State Trustees Limited, ACN 064 593 148, 168 Exhibition Street, Melbourne, Victoria 3000, the personal representative, on or before 11 October 2002

after which date State Trustees Limited may convey or distribute the assets having regard only to the claims of which State Trustees Limited then has notice.

MAY, Frederick Robert, formerly of 5 Weatherston Road, Seaford, late of Chelsea Private Nursing Home, 256 Station Street, Edithvale, pensioner, who died 23 July 2002.

QUINLAN, Harry, late of 184 Barkly Street, Brunswick, pensioner, who died 14 June 2002.

REID, Betty Alice, formerly of 18 Elizabeth Street, Elsternwick, late of Centennial House Lodge, 13 Lewis Road, Wantirna, home duties, who died 24 June 2002.

RUSOVIC, Milko, late of Unit 2, 77 Eskdale Road, Caulfield North, retired, who died 23 May 2002.

RYAN, Thelma Ada, late of Unit 4, 26 Missouri Avenue, Brighton, home duties, who died 5 June 2002.

WITT, Kenneth Sidney, late of Unit 2, 1 Park Avenue, Glen Huntly, who died 3 May 2002.

ZEMAN, Maria, late of 28 Showers Street, Preston, retired, who died 3 June 2002.

Dated at Melbourne, 2 August 2002

LAURIE TAYLOR
Manager, Estate Management
State Trustees Limited

STATE TRUSTEES LIMITED
ACN 064 593 148
Section 79

Notice is hereby given that State Trustees Limited, ACN 064 593 148 intends administering the estates of:-

EDNA MAY ADAMS, late of Clovelly Cottage, 16 Stewart Street, Boronia, Victoria, pensioner, deceased, who died 21 June 2002, leaving a will dated 17 June 1997.

NICOLAI CHERNISHOV, late of The Ukrainian Elderly Peoples Home, 344 Taylors Road, Delahey, Victoria, pensioner, deceased, who died 26 May 2002, leaving a will dated 3 August 1999.

KERRY ANGELA ROGERS, late of 23A Jericho Court, Berwick, Victoria, home duties, deceased intestate, who died 11 January 2002.

Creditors, next-of-kin and others having claims against the abovementioned estates are required pursuant to Section 33 of the **Trustee Act 1958** to send particulars of their claims against the abovementioned estates to State Trustees Limited, 168 Exhibition Street, Melbourne, Victoria, on or before 11 October 2002 after which date State Trustees Limited, ACN 064 593 148, may convey or distribute the assets of the abovementioned estates having regard only to the claims of which it then has notice.

Building Act 1993

BUILDING REGULATIONS 1994

Notice of Accreditation

Pursuant to Part 14 of the Building regulations 1994 a certificate of Accreditation (Number V02/04) has been issued to Karndean Australia (previously Chic Australia) of 91 Rushdale Street, Knoxfield, Victoria 3180 by the Building Commission for "Flotex 150/200 Sheet Carpet and Flotex Carpet Tiles".

The Building Regulations Advisory Committee appointed under Division 4 of Part 12 of the **Building Act 1993** after examination of an application for the accreditation of Flotex 150/200 Sheet Carpet and Flotex Carpet Tiles, as a floor covering for use in certain class 9 buildings, determined that Flotex 150/200 Sheet Carpet and Flotex Carpet Tiles comply with the requirements of:

Clauses CP3 and CP4 of Volume One of the Building Code of Australia 1996 as adopted by the Building Regulations 1994, as those Clauses apply to floor coverings in a patient-care area in a Class 9A building or in the auditorium or audience seating area in a Class 9B building not protected by a sprinkler system used as a theatre or public hall, and subject to the condition that the carpet must not be used in a fire isolated stairway, fire isolated passageway or fire isolated ramp. Identification details are provided in the four (4) data sheets attached.

COLIN McBURNEY
Secretary

Building Regulations Advisory Committee

Building Act 1993

BUILDING REGULATIONS 1994

Notice of Accreditation

Pursuant to Part 14 of the Building regulations 1994 a certificate of Accreditation (Number V02/03) has been issued to Interface Australia of 4 Henry Street, Picton, NSW 2571 by the Building Commission for Jakarta Carpet Tiles.

The Building Regulations Advisory Committee appointed under Division 4 of Part 12 of the **Building Act 1993** after examination of an application for the accreditation of "Jakarta Carpet Tiles" as a floor covering for use in certain class 9 buildings, determined that Jakarta Carpet Tiles comply with the requirements of:

Clauses CP3 and CP4 of Volume One of the Building Code of Australia 1996 as adopted by the Building Regulations 1994, as those Clauses apply to floor coverings in a patient-care area in a Class 9A building or in the auditorium or audience seating area in a Class 9B building not protected by a sprinkler system used as a theatre or public hall, and subject to the condition that the carpet must not be used in a fire isolated stairway, fire isolated passageway or fire isolated ramp or any vertical surface. Identification details are provided in the two (2) data sheets attached.

COLIN McBURNEY
Secretary

Building Regulations Advisory Committee

Children and Young Person Act 1989

Pursuant to Section 9(1)(b) of the **Children and Young Person Act 1989**, and by this notice, I direct that as of 5 August 2002, the Preston venue of the Children's Court shall close. I further direct that from that date the Heidelberg venue of the Court shall sit as a Children's Court, and that the class of proceedings that would have been returnable before the Preston venue of the Children's Court, will be returnable before the Heidelberg venue of the Children's Court. The Heidelberg venue of the Children's Court shall sit each Friday effective from 5 August 2002.

The address and contact details of the Heidelberg Children's Court are: Heidelberg

Children's Court, Jika Street, Heidelberg,
PO Box 105 (DX211906), Heidelberg 3084.
Phone: 8458 2000. Fax: 8458 2001.

Further direct that the notice dated 4 July 2002, in so far as the Children's Court is concerned is now revoked and this notice shall take effect immediately.

Dated 30 July 2002

Her Honour JENNIFER COATE
President
Children's Court of Victoria

Children's Services Act 1996

NOTICE OF EXEMPTION

I, Bronwyn Pike, Minister for Community Services and Housing, pursuant to section 6 of the **Children's Services Act 1996** (the Act), declare that Ararat Child Care Centre (Children's Services Licence Number 44) is exempt from the following regulations of the Children's Services Regulations 1998 (the Regulations)–

- Regulation 24 requiring the proprietor to ensure that whenever children are being cared for or educated by the children's service, the qualified staff members are as follows
 - a) 1 qualified staff member for 15 or less children present at the centre; and
 - b) where 16 or more children are present at the centre there is to be 1 qualified staff member for every 15 children or fraction of that number under 3 years of age and 1 qualified staff member for every 30 children or fraction of that number over three years of age.
- Regulation 25 requiring a person is a qualified staff member if that person–
 - a) has successfully completed a 2 year full-time, or part time equivalent, post secondary early childhood qualification which has been approved by the Secretary and notice of which has been published in the Government Gazette and in the publication circulating generally among children's services; and
 - b) holds a qualification that the Secretary is satisfied is substantially equivalent to a qualification referred to in paragraph (a).

This exemption is granted for a period of three months.

Declared at Melbourne on 24 June 2002

HON BRONWYN PIKE MP
Minister for Community Services
and Housing

Conservation, Forests and Lands Act 1987

NOTICE OF MAKING OF A LAND
MANAGEMENT CO-OPERATIVE
AGREEMENT

Notice is given under Section 80 of the **Conservation, Forests and Lands Act 1987** that a Land Management Co-operative Agreement has been entered into by the Secretary to the Department of Natural Resources and Environment with Barrie George Davis in relation to Crown Allotment 2A, Parish of Berrook.

A copy of the Agreement is available for public inspection between the hours of 9.00 a.m. and 5.00 p.m. at the following offices of the Department of Natural Resources and Environment: Mildura Office, Department of Natural Resources and Environment, 1st Floor, Fire Station Arcade, Langtree Avenue, Mildura 3500 and Executive Services Branch, Department of Natural Resources and Environment, Level 16, 8 Nicholson Street, East Melbourne 3002.

CHLOE MUNRO
Secretary

Dental Practice Act 1999

At a formal hearing of the Dental Practice Board of Victoria held on 23 May and 13 June 2002, Mr Kenneth Morriss, Dental Prosthetist of 21 Davey Street, Frankston, was found guilty of unprofessional conduct in that he charged fees to health care card holders over and above fees received from the community dental program for these patients.

He was reprimanded, fined \$4,000 and is not permitted to perform clinical procedures for patients under the Victorian Denture Scheme until 1 July 2004.

Electricity Industry Act 2000

NOTIFICATION OF VARIATION OF
ELECTRICITY RETAIL LICENCES

The Essential Services Commission gives notice under section 30 of the **Electricity Industry Act 2000** that it has, pursuant to section 29(1) of the **Electricity Industry Act 2000**, varied the electricity retail licences of –

- AGL Electricity Limited, (ACN 064 651 083);
- CitiPower Pty, (ACN 064 651 056);
- Origin Energy Electricity Ltd, (ACN 071 052 287);
- TXU Electricity Limited, (ACN 064 651 118);
- Pulse Energy Ltd, (ACN 090 538 337);
- ACTEW Retail Limited, (ACN 074 371 207) and AGL ACT Retail Investments Pty Ltd, (ACN 093 631 586) trading as ActewAGL Retail,
- Aurora Energy, (ACN 082 464 622);
- Australian Energy Services Pty Ltd, (ACN 067 609 803);
- Country Energy;
- Energy Australia;
- ENERGEX Retail Pty Ltd, (ACN 078 848 549);
- Enron Australia Energy Pty Limited, (ACN 082 245 887);
- Ergon Energy Pty Ltd, (ACN 078 875 902);
- Integral Energy Australia;
- Powercor Australia Limited, (ACN 064 651 109);
- TXU Pty Ltd, (ACN 086 014 968), and
- Yallourn Energy (trading as Auspower), (ACN 065 325 224).

The licences have been varied to clarify the retailers' obligation to comply with guidelines published by the Commission regarding confidentiality and informed consent and the inclusion of information about greenhouse gas emissions on customer's bills.

A copy of the licences may be obtained from the Commission's website located at <http://www.esc.vic.gov.au> or by contacting the Essential Services Commission, 2nd Floor,

35 Spring Street, Melbourne 3000 (telephone 03 9651 0222).

Dated 31 July 2002

JOHN C. TAMBLYN
Chairperson

Evidence Act 1958

MEDIATORS

I, Peter Harmsworth, Secretary to the Department of Justice, under the power found in section 21K of the **Evidence Act 1958**, declare each of the persons listed below to be a mediator with the Dispute Settlement Centre of Victoria:

Rita-Lucy WATKINS, Howard Besley Robert NICHOLLS, Merle BAMBLETT, Anthony James BROWN, Linda Anne LOVETT, Beverley Jean BURNS, Jacinta O'BREE, Lorraine Joyce FORRESTER, Raymond Thalep AHMAT, Jason Laurence Alfred McCARTHY, Petah ATKINSON, Layton BARKER, Trevor BARKER, Karlene Rose DWYER, Daphne Loretta MILWARD.

Dated 31 July 2002

PETER HARMSWORTH
Secretary to the
Department of Justice

Fisheries Act 1995

**MINISTERIAL GUIDELINES PURSUANT
TO SECTION 28(2) OF THE
FISHERIES ACT 1995**

I, Candy Broad, Minister for Energy and Resources, issue the following guidelines with respect to the preparation of a Management Plan for the Victorian giant crab Fishery in the western zone.

Fisheries Victoria will be responsible for the preparation of the Management Plan. The Fisheries Co-Management Council will oversee the process of preparing the Management Plan, in consultation with the relevant Fishery Committees.

The Management Plan will be prepared in consultation with all major stakeholder groups, including commercial, recreational, traditional, conservation and aquaculture interests.

In addition to the requirements of section 28 of the **Fisheries Act 1995**, the Management Plan shall address the following issues:

1. The Plan will define the process for reviewing management arrangements for the fishery including the total allowable catch (TAC), size limits and closed seasons.
2. The Plan will take account of Environment Australia's guidelines for assessing the ecologically sustainable management of fisheries.
3. The Plan will be consistent with the Victorian Government Response to the National Competition Policy (NCP) Review of the **Fisheries Act 1995**, released in December 2001.
 - (a) The Plan will address the need to define a threshold limit for the total allowable catch (TAC) above which mechanisms such as auctions, tender or ballot should be considered for the allocation of increases in the TAC.
 - (b) The Plan will address issues relating to pot limits in the giant crab fishery under an ITQ system.
4. The Plan will review the relationship between a Giant Crab Fishery Access Licence and a Rock Lobster Fishery Access Licence, and the prohibition of using giant crab pots in waters less than 150 m depth.
5. The Plan will review the 50 pot zone within the western zone known as the 'Apollo Bay paddock'.

Dated 25 July 2002

CANDY BROAD
Minister for Energy and Resources

Fisheries Act 1995

**MINISTERIAL GUIDELINES PURSUANT
TO SECTION 28(2) OF THE
FISHERIES ACT 1995**

I, Candy Broad, Minister for Energy and Resources, issue the following guidelines with respect to the preparation of a management plan for Victorian rock lobster fishery.

Fisheries Victoria will be responsible for the preparation of the Management Plan. The Fisheries Co-Management Council will oversee the process of preparing the Management Plan, in consultation with the relevant Fishery Committees.

The Management Plan will be prepared in consultation with all major stakeholder groups, including commercial, recreational, traditional, conservation and aquaculture interests.

1. The Plan will define the process for reviewing management arrangements for the fishery including the total allowable catch (TAC), size limits and closed seasons.
2. The Plan will take account of Environment Australia's guidelines for assessing the ecologically sustainable management of fisheries.
3. The Plan will be consistent with the Victorian Government Response to the National Competition Policy (NCP) Review of the **Fisheries Act 1995**, released in December 2001.
 - (a) The Plan will address the need to define a threshold limit for the total allowable catch (TAC) in each zone above which mechanisms such as auctions, tender or ballot should be considered for the allocation of increases in the TAC.
 - (b) The Plan will address issues relating to pot limits in the rock lobster fishery under an ITQ system, and the relationship between the pot entitlement on a Rock Lobster Fishery Access Licence and the number of individual quota units held on that licence.
4. The Plan will review the management zones within the fishery including:
 - (a) The 50 pot zone within the western zone known as the 'Apollo Bay paddock';
 - (b) The area in the eastern zone known as the "eastern zone corridor";
 - (c) The possible creation of a separate far eastern zone.
5. The Plan will review arrangements, including compliance, relating to rock lobsters taken from Victorian waters being landed at ports in another State.
6. The Plan will review the management arrangements for the recreational rock lobster fishery, including the use of hookah equipment for recreational purposes.
7. The Plan will review interstate and overseas policies in examining the potential opportunities for aquaculture of rock lobsters.

Dated 25 July 2002

CANDY BROAD
Minister for Energy and Resources

Government Superannuation Act 1999
ELECTIONS OF DIRECTORS/DEPUTY
DIRECTORS OF THE GOVERNMENT
SUPERANNUATION OFFICE

Notice is given of an election for three (3) positions of Director and Deputy Director under sections 10 and 12 of the **Government Superannuation Act 1999**. The elected members will be required to fulfil the duties of the Directors and Deputy Directors and hold office until 30 November 2005.

The election will be conducted in accordance with the Government Superannuation Office 2002 Board Election Procedures and take place on Friday 11 October 2002.

Nominations are to be on the approved Nomination Form and must be received by the Returning Officer, Ms Shirley Bean, at the Victorian Electoral Commission (VEC), Level 8, 505 Little Collins Street, Melbourne 3000, no later than 12 o'clock noon on Friday 13 September 2002.

Nomination forms may be obtained from the VEC by telephoning 13 18 32.

If a ballot is necessary to decide the election, a 'draw' to determine the candidates positions on the ballot paper will be conducted at the Victorian Electoral Commission at 10.00 am on Tuesday 17 September 2002.

Ballot material will be posted to members on Friday 27 September 2002 and the ballot will close at 4.00 pm on Friday 11 October 2002.

Dated 8 August 2002

DENZIL GRIFFITHS
Chief Executive
Government Superannuation Office

Land Act 1958
SECTION 134A

Notice of Application for Stratum Leases

Notice is hereby given that Melbourne Central Custodian Pty Ltd, ABN 34 006 470 560 has applied for stratum leases pursuant to Section 134A of the **Land Act 1958** for a term of 50 years in respect of the following parcels of Crown land for the purposes of pedestrian access and retail activities:

- Crown Allotment 14A being a bridge over Lonsdale Street, Melbourne;

- Crown Allotment 2025/OP121847 being a bridge over Little Lonsdale Street, Melbourne;
- Crown Allotment 2024/OP 121846 being a tunnel under Little Lonsdale Street, Melbourne.

The proposed lease over Lonsdale Street represents a conversion of existing Licence No. 4/138A over an identical area, and the proposed leases over and under Little Lonsdale Street represent conversions of existing Licence Nos. 6/138A and 5/138A over expanded areas.

Local Government Act 1989

APPROVAL OF AGREEMENT BETWEEN
THE CARDINIA SHIRE COUNCIL AND
THE CASEY CITY COUNCIL TO OPERATE
A REGIONAL LIBRARY CORPORATION

I, Bob Cameron, MP, Minister for Local Government, acting pursuant to Section 196 (2) of the **Local Government Act 1989** hereby approve of the Agreement executed by the Cardinia Shire Council and the Casey City Council for the operation of a Regional Library Corporation under section 196 of the **Local Government Act 1989**.

Dated 1 August 2002

BOB CAMERON MP
Minister for Local Government

Pipelines Act 1967

PIPELINE LICENCE 17-LATERAL
DEVIATION

I, the Delegate of the Minister for Energy and Resources for the State of Victoria, in accordance with the provisions of Section 31 of the **Pipelines Act 1967**, hereby authorise a lateral deviation of the route of the 150 mm nominal diameter West Melbourne to Derrimut natural gas pipeline for a length of approximately 400 metres along a section within Cowper Street, Docklands as shown in Drawing Nos T10-11-41, T10-11-42, T10-11-43, R T10-13 Rev B and R T10-14 Rev A which accompanied TXU Networks Proprietary Limited application dated 31 July 2002.

Dated 6 August 2002

HORACIO HAAG
Manager, Petroleum Operations,
Safety and Environment
Pursuant to Instrument of Delegation
dated 18 November 1999.

Pipelines Act 1967 (Vic)

VARIATION OF THE PERMIT TO OWN
AND USE A PIPELINE 101

Section 12(4)

I, the Minister for Energy and Resources for the State of Victoria, hereby give notice in accordance with the provisions of Section 12(4) of the **Pipelines Act 1967 (Vic)**, that the Permit to Own and Use a Pipeline 101, owned by GasNet Australia (Operations) Pty Ltd of 180 Greens Road, Dandenong, Vic. 3175 is varied by the:-

ADDITION of endorsed Route Plan drawing T74-99, dated 22 February 2002.

Dated 25 July 2002

CANDY BROAD
Minister for Energy
and Resources

Transport Act 1983

TOW TRUCK DIRECTORATE OF
VICTORIA

Tow Truck Application

Notice is hereby given that the following applications will be considered by the Licensing Authority after 11 September 2002.

Notice of any objection to the granting of an application should be forwarded to reach the Director, Tow Truck Directorate of Victoria, Level 6, 14-20 Blackwood Street, North Melbourne (PO Box 666, North Melbourne 3051) not later than 5 September 2002.

It will not be necessary for interested parties to appear on the date specified, unless advised in writing.

Azlink Pty Ltd. Application for variation of conditions of tow truck licence number TOW333 which authorises the licensed vehicle to be managed, controlled and operated from a depot situated at 108-110 Geelong Road, Torquay to change the depot address to 91 Beach Road (West), Torquay.

Note: This licence is under consideration for transfer to Torquay Panel Beating Pty Ltd.

Modern Towing & Salvage (Aust) Pty Ltd. Application for variation of conditions of tow truck licence numbers TOW035 and TOW036 which authorises the licensed vehicles to be managed, controlled and operated from a

depot situated at 667 Waterdale Road, West Heidelberg to change the depot address to 2-4 St Georges Road, North Fitzroy.

Note: These licences are under consideration for transfer to Varapodio Nominees Pty Ltd.

Dated 8 August 2002

STEVE STANKO
Director

Transport Act 1983

VICTORIAN TAXI DIRECTORATE

Department of Infrastructure

Commercial Passenger Vehicle Applications

Notice is hereby given that the following applications will be considered by the Victorian Taxi Directorate, a division of the Department of Infrastructure after 11 September 2002.

Notice of any objection to the granting of an application should be forwarded to reach the Manager, Licensing & Certification, Victorian Taxi Directorate, Level 6, 14-20 Blackwood Street, North Melbourne (PO Box 666, North Melbourne 3051) not later than 4 September 2002.

Copies of objections are forwarded to the applicants.

It will not be necessary for interested parties to appear on the date specified, unless advised in writing by the Department.

Luxury Limousines – Victoria Pty Ltd, Warrnambool. Application for variation of conditions of licence SV1391 which authorises the licensed vehicle to operate in respect of a 1980 Cadillac stretched limousine with seating capacity for 12 or fewer passengers for the carriage of passengers for wedding parties within a one hundred kilometre (100km) radius of Warrnambool Post Office to change the vehicle to a 1994 or later Ford Stretch limousine with seating capacity for 12 or fewer passengers and to include the ability to operate for carriage of passengers to the Spring Racing Carnival, tours of the Great Southern Touring Route and AFL football, Theatre, restaurant and Casino trips.

Dated 6 August 2002

ROBERT STONEHAM
Manager – Licensing and Certification
Victorian Taxi Directorate

Plant Health and Plant Products Act 1995

NOTICE OF EXTENSION OF ORDER
PROHIBITING OR RESTRICTING THE
ENTRY OR IMPORTATION OF
CONTAINERISED PLANTS, PLANT
MULCH, TURF, USED CONTAINERS,
AGRICULTURAL MACHINERY AND SOIL
INTO VICTORIA TO PREVENT THE
ENTRY OF THE EXOTIC PEST FIRE ANT

I, Keith Hamilton, Minister for Agriculture, under section 27(2) of the **Plant Health and Plant Products Act 1995** extend the order made on 21 August 2001 under section 24 of that Act prohibiting or restricting the entry or importation of containerised plants, plant mulch, turf, used containers, agricultural machinery and soil into Victoria to prevent the entry of the exotic pest fire ant for a period of 12 months commencing on 21 August 2002. Notice of that order was published in Government Gazette G34 on 23 August 2001 (page 1958).

The order prohibits subject to conditions or restricts the entry or importation of any containerised plant, plant mulch, turf, used container, agricultural equipment, and soil so as to prevent the introduction or spread of the exotic pest fire ant *Solenopsis invicta* into Victoria.

A copy of the order may be obtained by contacting the Plant Standards Branch on (03) 9210 9390.

Dated 31 July 2002

KEITH HAMILTON MP
Minister for Agriculture

Water Act 1989

GOULBURN-MURRAY RURAL WATER AUTHORITY

Notice of Making By-Law No. 4

Temporary Transfer of Water

In accordance with Section 161 of the **Water Act 1989** notice is hereby given that the Authority has made By-Law No. 4 Temporary Transfer of Water.

This by-law may be cited as By-Law No. 4 Temporary Transfer of Water and replaces Authority by-law No. 2.

The objectives of this by-law are to:-

- (a) make provision for the temporary transfer of water rights and sales water –
 - (i) within and out of certain irrigation districts of the Authority and within Victoria; and
 - (ii) out of certain irrigation districts of the Authority to the owner or occupier of any land outside Victoria; and
- (b) prescribe fees for processing and approving applications.

A copy of the by-law may be inspected, free of charge, during business hours at the Corporate Office of the Authority, 40 Casey Street, Tatura.

DENIS FLETT
Chief Executive Officer

Water Act 1989

LOWER MURRAY REGION WATER
AUTHORITY

I, Adrian Spall, Director, Water Sector Services, Department of Natural Resources and Environment, as the delegate of the Minister for Environment and Conservation, make the following Order:

EXTENSION OF THE SUNRAYSIA
SEWERAGE DISTRICT ORDER 2002

1. This Order is called the extension of the Sunraysia Sewerage District Order 2002.
2. This Order is made under Section 96(11) of the **Water Act 1989** and all other available powers.
3. The proposal dated 20 June 2002 for the extension of the Sunraysia Sewerage District of the Lower Murray Region Water Authority submitted to the Minister for Environment and Conservation by Lower Murray Water Region Water Authority is approved.
4. The Sunraysia Sewerage District of the Lower Murray Region Water Authority is extended to include areas bordered in red on the accompanying Plan "11-MD-03" a copy of which may be inspected at the offices of

the Lower Murray Region Water Authority, situated at Fourteenth Street, Mildura 3502.

Dated 25 July 2002

ADRIAN SPALL
Director, Water Sector Services
Department of Natural Resources
and Environment
(as delegate of the Minister
for Environment and Conservation)

Water Act 1989

LOWER MURRAY REGION WATER
AUTHORITY

I, Adrian Spall, Director, Water Sector Services, Department of Natural Resources and Environment, as the delegate of the Minister for Environment and Conservation, make the following Order:

EXTENSION OF THE ROBINVALE
SEWERAGE DISTRICT ORDER 2002

1. This Order is called the extension of the Robinvale Sewerage District Order 2002.
2. This Order is made under Section 96(11) of the **Water Act 1989** and all other available powers.
3. The proposal dated 20 June 2002 for the extension of the Robinvale Sewerage District of the Lower Murray Region Water Authority submitted to the Minister for Environment and Conservation by Lower Murray Water Region Water Authority is approved.
4. The Robinvale Sewerage District of the Lower Murray Region Water Authority is extended to include areas bordered in red on the accompanying Plan "11-RB-02" a copy of which may be inspected at the offices of the Lower Murray Region Water Authority, situated at Fourteenth Street, Mildura 3502.

Dated 23 July 2002

ADRIAN SPALL
Director, Water Sector Services
Department of Natural Resources
and Environment
(as delegate of the Minister
for Environment and Conservation)

Water Act 1989**LOWER MURRAY REGION WATER AUTHORITY**

I, Adrian Spall, Director, Water Sector Services, Department of Natural Resources and Environment, as the delegate of the Minister for Environment and Conservation, make the following Order:

EXTENSION OF THE ROBINVALE URBAN DISTRICT ORDER 2002

1. This Order is called the extension of the Robinvale Urban District Order 2002.
2. This Order is made under Section 96(11) of the **Water Act 1989** and all other available powers.
3. The proposal dated 20 June 2002 for the extension of the Robinvale Urban District of the Lower Murray Region Water Authority submitted to the Minister for Environment and Conservation by Lower Murray Water Region Water Authority is approved.
4. The Robinvale Urban District of the Lower Murray Region Water Authority is extended to include areas bordered in red on the accompanying Plan "10-RB-02" a copy of which may be inspected at the offices of the Lower Murray Region Water Authority, situated at Fourteenth Street, Mildura 3502.

Dated 25 July 2002

ADRIAN SPALL
Director, Water Sector Services
Department of Natural Resources
and Environment
(as delegate of the Minister
for Environment and Conservation)

Geographic Place Names Act 1998**NOTICE OF REGISTRATION OF GEOGRAPHIC NAMES**

The Registrar of Geographic Names hereby gives notice of the registration of the undermentioned place names.

File No.	Place Name	Proposer & Location
GPN 453	Saint Vincents Plaza	Yarra City Council. Tram stop at intersection of Victoria Parade and Brunswick Street, Fitzroy.

Office of the Registrar of Geographic Names
c/-**LAND VICTORIA**
15th Floor,
570 Bourke Street,
Melbourne 3000

KEITH C. BELL
Registrar of Geographic Names

Geographic Place Names Act 1998**REGISTRATION OF AMENDMENT OF GEOGRAPHIC NAMES**

The Registrar of Geographic Names hereby gives notice of the registration of amendment of the undermentioned place names.

File No.	Place Name	Proposer & Location
GPN 452	From Victoria Dock to Victoria Harbour	Docklands Authority. As shown on Map 2E, D5 of the Melway Street Directory.
PNC 1668	Parts of: <ul style="list-style-type: none"> ● Noble Park to Springvale South ● Noble Park to Springvale ● Springvale South to Noble Park ● Noble Park North to Dandenong North ● Keysborough to Noble Park 	City of Greater Dandenong. As shown on version 4.3 of the map showing the suburb names and boundaries within the municipality. These plans can be viewed at the municipal offices or at the office of the Registrar of Geographic Names.
PNC 1705	Parts of: <ul style="list-style-type: none"> ● Whitlands to Whitfield ● Whitlands to Cheshunt ● Tolmie to Cheshunt ● Myrree to Whitlands ● Myrree to Whitfield ● Whitfield to Whitlands ● Edi to King Valley ● Markwood to Milawa ● Wangaratta South to Glenrowan 	Rural City of Wangaratta. As shown on version 4.3 of the map showing the town and rural district names and boundaries within the municipality. These plans can be viewed at the municipal offices or at the office of the Registrar of Geographic Names.

Office of the Registrar of Geographic Names

c/-LAND VICTORIA

15th Floor,
570 Bourke Street,
Melbourne 3000

KEITH C. BELL
Registrar of Geographic Names

Occupational Health and Safety Act 1985

VICTORIAN WORKCOVER AUTHORITY

Notice of Issue of Major Hazard Licence

On 24 July 2002, a licence under Part 8 of the Occupational Health and Safety (Major Hazard Facilities) Regulations 2000 was issued to Australian Vinyls Corporation Limited, 65 Leakes Road, Laverton, Victoria 3028 and authorises the facility, located at 65 Leakes Road, Laverton, Victoria, to be operated as a major hazard facility.

The Major Hazard Facility Licence was issued for a term of 5 years and will expire on 20 June 2007.

The licence did not include conditions.

The following Schedule 1 materials were authorised by the licence:

From Table 1 of Schedule 1

Material	UN Nos included or excluded under name
Ammonia	1001
Chlorine	1017
Methane or Natural Gas	1971 & 1972

From Table 2 of Schedule 1

Material	Description
Compressed and liquefied gases	Compressed or liquefied gases of Class 2.1
Flammable materials	Liquids which meet the criteria for Class 3 Packing Group II
Oxidising Materials	Oxidising materials that meet the criteria for Class 5.1 Packing Group II
Peroxides	Organic Peroxides which meet the criteria for Class 5.2
Toxic Solids and liquids	Materials which meet the criteria for Toxic in Table 3

BILL MOUNTFORD
Chief Executive

Land Acquisition and Compensation Act 1986

FORM 7

Notice of Acquisition

Compulsory Acquisition of Interest in Land

To: David Francis THOMPSON,
Laura Christine THOMPSON,
Both of RMB 4295, Koroit, Vic. 3282
As Registered Proprietors

To: Rural Finance Corporation of Victoria,
GPO Box 1334L, Melbourne, Vic. 3001
As Mortgagee No V469433A

SOUTH EAST AUSTRALIA GAS PTY LTD, ABN 73 096 437 900 of Level 13, 1 King William Street, Adelaide, SA 5000 as agent of:

OE SEA Gas SPV1 Pty Ltd (ACN 095 483 444);

OE SEA Gas SPV2 Pty Ltd (ACN 095 483 453); and,

OE SEA Gas SPV3 Pty Ltd (ACN 095 483 462);

all of c/- Level 13, 1 King William Street, Adelaide, SA 5000; and,

ANP SEA Gas SPV1 Pty Ltd (ACN 099 332 331);

ANP SEA Gas SPV2 Pty Ltd (ACN 099 332 368); and,

ANP SEA Gas SPV3 Pty Ltd (ACN 099 332 395);

all of c/- Level 37, Rialto North Tower, 525 Collins Street, Melbourne, Vic. 3000

as partners in the SEA Gas Partnership ("the Partners") (together referred to as ("the Authority"))

declares that by this notice it acquires the following interest in the land described as:

a Right of Way and Easement over that piece of land being portion of the land comprised and described in Certificates of Title Register Books Volume 10101, Folio 664 and Volume 2868, Folio

495, the location of which is marked E1 on the Plans annexed hereto ("the Easement Land").

Extent of Interest Vested in Authority

- 1 A full and unrestricted right and liberty over the Easement Land for the Authority from time to time and at all times hereafter, to enter and exit from the Easement Land with or without motor vehicles, engines, plant and equipment and to remain on the Easement Land for any of the purposes set out in this Easement namely:
 - (a) to clear any vegetation or obstruction on the Easement Land;
 - (b) to make surveys;
 - (c) to dig, excavate and break the soil of the Easement Land;
 - (d) to install, operate, maintain, repair, alter, inspect, remove or remove and replace a pipeline or pipelines and to use such pipeline or pipelines to carry, convey and transport natural and artificial gas, oil and other gaseous or liquid hydrocarbons and products or by-products of these substances ("gas supply purposes").
- 2 The registered proprietor of the Easement Land shall not and shall not permit any other person without the prior written consent of the Authority (which will not be unreasonably withheld or delayed) to:
 - (a) excavate, dig, drill, grade or change the contour of the Easement Land;
 - (b) construct or erect any building or other permanent structure on the Easement Land;
 - (c) plant or cultivate trees on the Easement Land;
 - (d) carry out blasting on or within 500 metres of the Easement Land;
 - (e) conduct any activity which constitutes a nuisance or hindrance to the exercise by the Grantee of its rights under this Easement.
- 3
 - (a) The pipeline shall remain the property of the Authority despite the degree of annexation (if any) of the pipeline to the Easement Land; and
 - (b) The Authority may at any time remove the pipeline and/or elements of the pipeline from the Easement Land and will reinstate any damage done to the Easement Land caused by that removal.

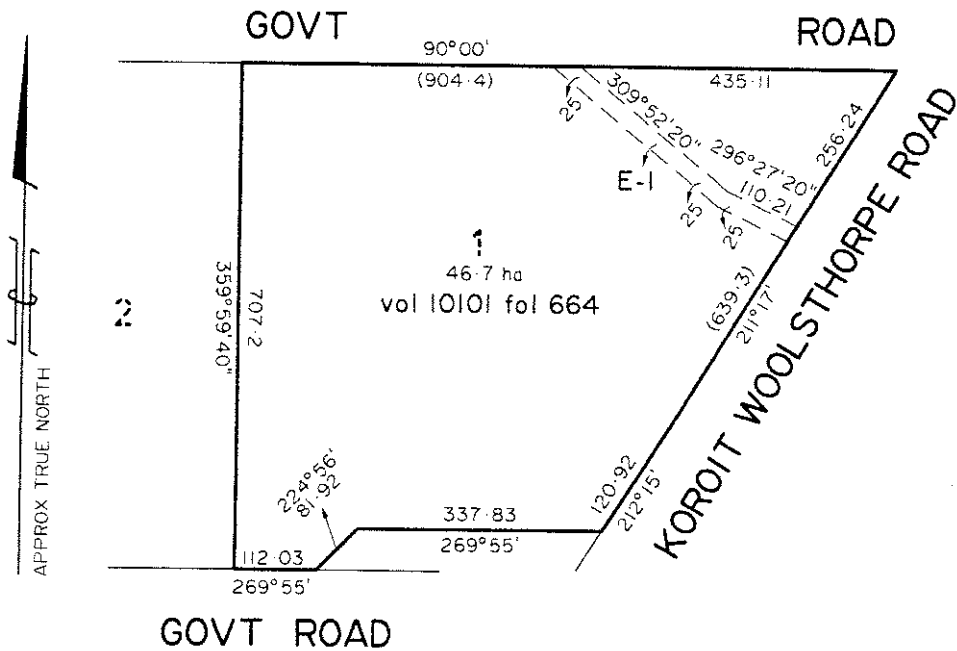

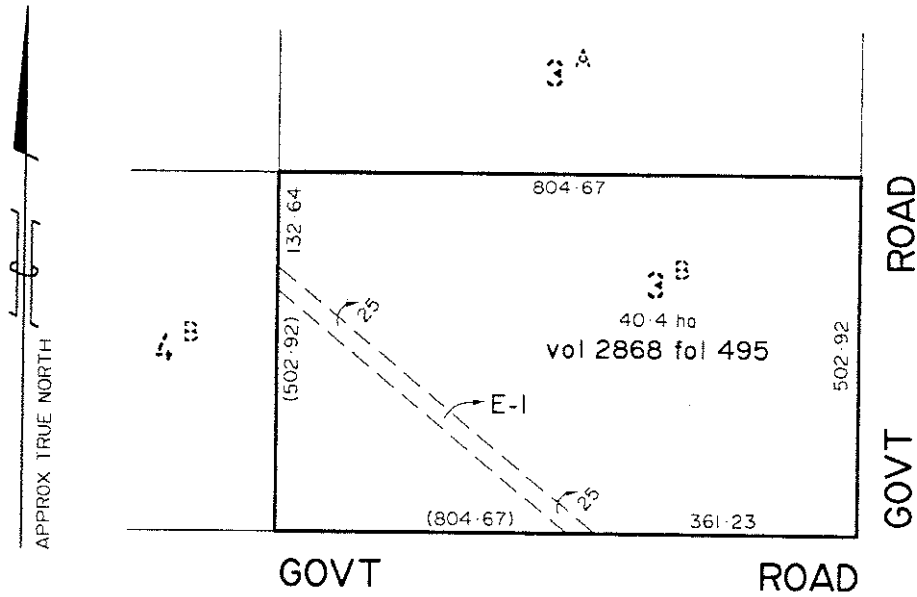

Published with the authority of the Authority.

For and on behalf of the Authority:

Dated 5 August 2002

SIGNED by Andrew John Wauchope)
of Level 13, 1 King William Street,)
Adelaide, SA 5000)

SOUTH EAST AUSTRALIA GAS)
PTY LIMITED by its attorney who)
states that he has received no notice)
of revocation of his Power of)
Attorney)

As attorney for SOUTH EAST AUSTRALIA)
GAS PTY LIMITED under Power of)
Attorney dated 9/5/2002)

(SIGNED) _____
(Signature)

in the presence of an independent adult
witness who either knows the attorney
personally or who has been given
satisfactory proof as to their identity.

Witness sign: _____ (SIGNED)

Witness Full Name (print): CAROL ANNE LLEWELLYN

Address: C/- Level 2, 122 Frome Street,

Adelaide, SA 5000

Daytime Phone No: (08) 8224 3611

Land Acquisition and Compensation Act 1986

FORM 7

Notice of Acquisition

Compulsory Acquisition of Interest in Land

- To: David Willison LESLIE
and
- To: Winifred Irene LESLIE
and
- To: Richard David LESLIE
and
- To: Stephen John LESLIE
and
- To: Anthony Alexander LESLIE
All of 1324 Penhurst – Warrnambool Road, Warrong via Koroit, Vic. 3282
As Tenants in Common in Unequal Shares

SOUTH EAST AUSTRALIA GAS PTY LTD ABN 73 096 437 900 of Level 13, 1 King William Street, Adelaide SA 5000 as agent of:

OE SEA Gas SPV1 Pty Ltd (ACN 095 483 444);

OE SEA Gas SPV2 Pty Ltd (ACN 095 483 453); and,

OE SEA Gas SPV3 Pty Ltd (ACN 095 483 462);

all of c/- Level 13, 1 King William Street, Adelaide SA 5000; and,

ANP SEA Gas SPV1 Pty Ltd (ACN 099 332 331);

ANP SEA Gas SPV2 Pty Ltd (ACN 099 332 368); and,

ANP SEA Gas SPV3 Pty Ltd (ACN 099 332 395);

all of c/- Level 37, Rialto North Tower, 525 Collins Street, Melbourne VIC 3000

as partners in the SEA Gas Partnership (“the Partners”) (together referred to as (“the Authority”))

declares that by this notice it acquires the following interest in the land described as:

a Right of Way and Easement over that piece of land being portion of the land comprised and described in Certificates of Title Register Books Volume 8856, Folio 565 and Volume 8950, Folio 303 the location of which is marked E1 on the Plans annexed hereto (“the Easement Land”).

Extent of Interest Vested in Authority

- 1 A full and unrestricted right and liberty over the Easement Land for the Authority from time to time and at all times hereafter, to enter and exit from the Easement Land with or without motor vehicles, engines, plant and equipment and to remain on the Easement Land for any of the purposes set out in this Easement namely:
 - (a) to clear any vegetation or obstruction on the Easement Land;
 - (b) to make surveys;
 - (c) to dig, excavate and break the soil of the Easement Land;
 - (d) to install, operate, maintain, repair, alter, inspect, remove or remove and replace a pipeline or pipelines and to use such pipeline or pipelines to carry, convey and transport natural and artificial gas, oil and other gaseous or liquid hydrocarbons and products or by-products of these substances (“gas supply purposes”).
- 2 The registered proprietor of the Easement Land shall not and shall not permit any other person without the prior written consent of the Authority (which will not be unreasonably withheld or delayed) to:

- (a) excavate, dig, drill, grade or change the contour of the Easement Land;
 - (b) construct or erect any building or other permanent structure on the Easement Land;
 - (c) plant or cultivate trees on the Easement Land;
 - (d) carry out blasting on or within 500 metres of the Easement Land;
 - (e) conduct any activity which constitutes a nuisance or hindrance to the exercise by the Grantee of its rights under this Easement.
- 3
- (a) The pipeline shall remain the property of the Authority despite the degree of annexation (if any) of the pipeline to the Easement Land; and
 - (b) The Authority may at any time remove the pipeline and/or elements of the pipeline from the Easement Land and will reinstate any damage done to the Easement Land caused by that removal.

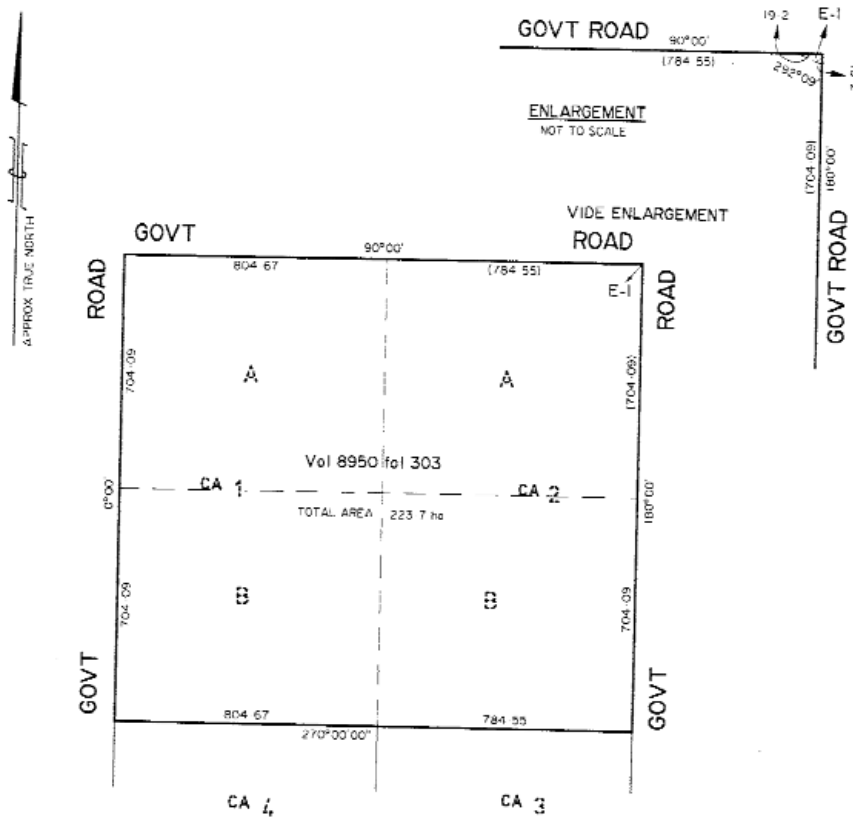

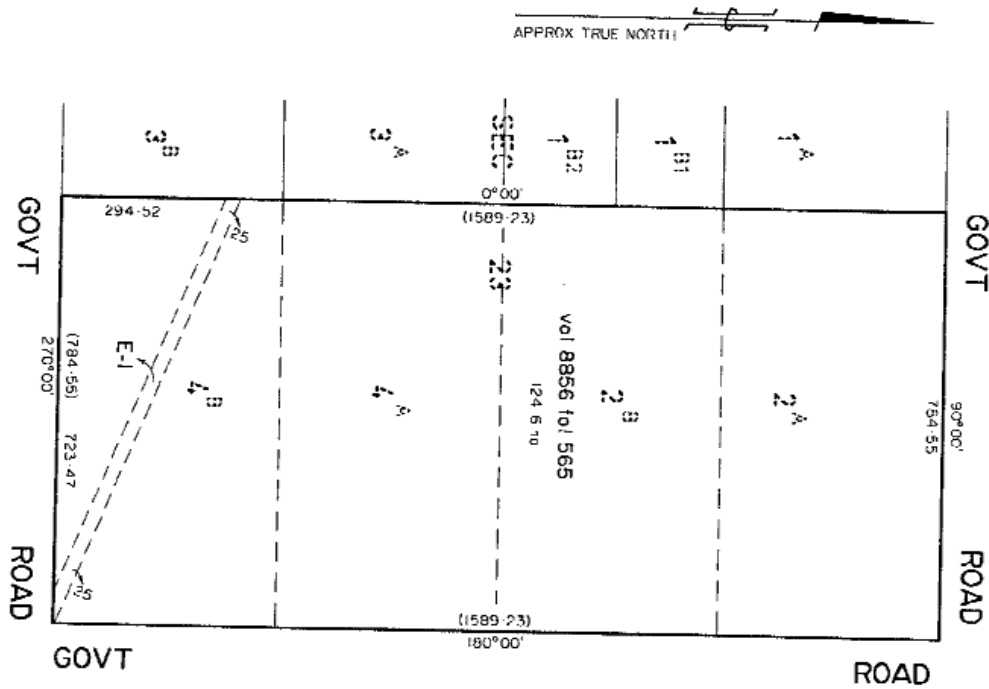

Published with the authority of the Authority.

For and on behalf of the Authority:

Dated 31 July 2002

SIGNED by Andrew John Wauchope
of Level 13, 1 King William Street,
Adelaide SA 5000

As attorney for SOUTH EAST AUSTRALIA
GAS PTY LIMITED under Power of
Attorney dated 9/5/2002

) SOUTH EAST AUSTRALIA GAS
) PTY LIMITED by its attorney who
) states that he has received no notice
) of revocation of his Power of
) Attorney

(SIGNED)

(Signature)

in the presence of an independent adult
witness who either knows the attorney
personally or who has been given
satisfactory proof as to their identity.

Witness sign: _____ (SIGNED)

Witness Full Name (print): CAROL ANNE LLEWELLYN

Address: C/- Level 2, 122 Frome Street,

Adelaide, SA 5000

Daytime Phone No: (08) 8224 3611

Trustee Companies Act 1984

SANDHURST TRUSTEES LTD. A.C.N. 004 030 737

18 View Street, Bendigo, Victoria 3550

Schedule of Fees and Commissions

Inclusive of GST – effective 1 August 2002

Estate Administration

- Capital commission:

Where the gross value of the estate does not exceed \$500,000	5.5% gross value
On the next \$250,000	4.4%
On the next \$250,000	3.3%
On any amount in excess of \$1 million	1.1%
 - Income commission: 6.6% income per annum
 - Administration fee on perpetual trusts (in lieu of income commission) 1.056% gross value trust per annum
 - Testamentary trusts (in lieu of income commission) – available on application.
-

Planning and Environment Act 1987

MAROONDAH PLANNING SCHEME

Notice of Approval of Amendment

Amendment C28

The Minister for Planning has approved Amendment C28 to the Maroondah Planning Scheme.

The Amendment comes into operation on the date this notice is published in the Government Gazette.

The Amendment introduces heritage controls affecting the house and land at 343 Maroondah Highway, Croydon North by including the land in the Schedule to the Heritage Overlay, on an interim basis, whilst another amendment (to the same effect), to be processed by the Maroondah City Council, can proceed following due process to finality.

A copy of the Amendment can be inspected, free of charge, during office hours, at the Department of Infrastructure, Planning Information Centre, Upper Plaza, Nauru House, 80 Collins Street, Melbourne and at the offices of the Maroondah City Council, Braeside Avenue, Ringwood.

PAUL JEROME
Executive Director
Planning, Heritage and
Building Division
Department of Infrastructure

Planning and Environment Act 1987

PORT PHILLIP PLANNING SCHEME

Notice of Approval of Amendment

Amendment C30

The Minister for Planning has approved Amendment C30 to the Port Phillip Planning Scheme.

The Amendment comes into operation on the date this notice is published in the Government Gazette.

The Amendment corrects an error that occurred in translation to the new format Port Phillip Planning Scheme and ensures that the subject land cannot be developed in a manner that would adversely impact on the Shrine Vista.

A copy of the Amendment can be inspected, free of charge, during office hours, at the Department of Infrastructure, Planning Information Centre, Upper Plaza, Nauru House, 80 Collins Street, Melbourne and at the offices of the Port Phillip City Council, South Melbourne Town Hall, 208 Bank Street, South Melbourne.

PAUL JEROME
Executive Director
Planning, Heritage and
Building Division
Department of Infrastructure

Planning and Environment Act 1987

YARRA PLANNING SCHEME

Notice of Approval of Amendment

Amendment C37

The Minister for Planning has approved Amendment C37 to the Yarra Planning Scheme.

The Amendment comes into operation on the date this notice is published in the Government Gazette.

The Amendment rezones all land located along the eastern side of Taplin Street (except 28–42 Taplin Street); 136, 140 and 142 Park Street; and 251–257 St. Georges Road, North Fitzroy from the Business 3 Zone to the Mixed Use Zone, and includes the land in the Environmental Audit Overlay.

A copy of the Amendment can be inspected, free of charge, during office hours, at the Department of Infrastructure, Planning Information Centre, Upper Plaza, Nauru House, 80 Collins Street, Melbourne and at the offices of the Yarra City Council, Richmond Town Hall, 333 Bridge Road, Richmond.

PAUL JEROME
Executive Director
Planning, Heritage and
Building Division
Department of Infrastructure

Planning and Environment Act 1987

YARRA RANGES PLANNING SCHEME

Notice of Approval of Amendment

Amendment C27

The Minister for Planning has approved Amendment C27 to the Yarra Ranges Planning Scheme.

The Amendment comes into operation on the date this notice is published in the Government Gazette.

The Amendment changes the provisions of Schedule 2 to the Special Use Zone relating to land at Lot 1 PS129590, Martyr Road, Warburton to clarify that use and subdivision do not require a planning permit. This change re-instates the provisions that were in Amendment L33 to the former Upper Yarra Planning Scheme, but were omitted from the new format Yarra Ranges Planning Scheme in error. The Amendment also extends the time limit for commencement of development until 1 December 2003 and completion of development until 1 December 2008.

A copy of the Amendment can be inspected, free of charge, during office hours, at the Department of Infrastructure, Planning Information Centre, Upper Plaza, Nauru House, 80 Collins Street, Melbourne and at the offices of the Yarra Ranges Shire Council, Anderson Street, Lilydale.

PAUL JEROME
Executive Director
Planning, Heritage and
Building Division
Department of Infrastructure

Planning and Environment Act 1987

BRIMBANK PLANNING SCHEME

Notice of Lapsing of Amendment

Amendment C31

The Kingston City Council has resolved to abandon Amendment C31 to the Brimbank Planning Scheme.

The Amendment proposed to rezone 42 Devonshire Road and 32 to 34 Martin Street, Sunshine to Business 2 Zone, include the land in an Environmental Audit Overlay and include in

2190 G 32 8 August 2002

Victoria Government Gazette

the Schedule to the Business 2 Zone at Clause 34.02 a limit of 2500 square metres of office space.

The Amendment lapsed on 27 September 2001.

PAUL JEROME
Executive Director
Planning, Heritage and
Building Division
Department of Infrastructure

ORDERS IN COUNCIL**Cemeteries Act 1958**

SCALE OF FEES

Order in Council

Under Section 17(1) of the **Cemeteries Act 1958**, and on the recommendation of the Minister for Health, the Governor-in-Council consents to the making of the Scales of Fees in respect of the following Public Cemetery Trusts:

Keilor
 Mornington Peninsula
 Timor
 Toolamba
 Upper Yarra

Cemeteries Act 1958

SCALE OF FEES

By resolution of the Trust, the following fees will apply in the Keilor Cemetery from the date of approval by the Governor in Council. All other fees are rescinded to the extent to which they conflict with this scale.

FEE FOR RIGHT OF BURIAL	At Need \$	Pre Need \$
Earth Grave	1,200.00	1,350.00
Lawn Grave	1,650.00	1,900.00
Concrete Foundation Grave	2,550.00	2,800.00
Concrete Lined Grave	8,000.00	9,000.00
INTERMENT FEES		
Weekdays		1,100.00
Children under 5 years (in adult grave)		500.00
Saturdays (extra)		600.00
Sundays/Public Holidays (extra)		700.00
Interment out of normal hours (extra)		200.00
Additional depth for 3 interments (extra)		200.00
Interment of cremated remains in a grave		150.00
BRONZE PLAQUES (560MM X 305MM) FOR LAWN GRAVES		
Single interment		650.00
Dual interment (includes first nameplate)		700.00
Additional nameplate		150.00
Book of Life (first page)		750.00
Book of Life (second page)		300.00
Photo – 5cm x 7cm		200.00
Photo – 7cm x 9cm		250.00
Affixing plaque supplied by others		150.00

VASES FOR LAWN GRAVES

Bronze vase 100.00

Plastic vase 40.00

MISCELLANEOUS FEES

Exhumation fee (when authorised) 2,500.00

Cancellation of an order to dig a grave 200.00

Remove/replace ledger 250.00

Fee for all monumental work \$10% of contract price

Search fee 30.00

Sand/other special material for backfilling 200.00

CREMATION MEMORIALS

	No. of positions	Location of plaque	Size of plaque	Fee (excluding plaque) \$
Arbor Rock Garden	4	rock	b,c	1,700.00
Arbor Rose Garden				
–shared rose	2	all on	b	1,000.00
–family rose	4	bluestone	b	1,900.00
–weeping rose	2	edging	b	1,300.00
–memorial tree	2		b	1,000.00
Northern Memorial Gardens	1	granite base	b,c,d	600.00
Eastern Memorial Gardens	1	granite base	b,c,d	600.00
Memorial Avenue Gardens	1	granite base	b,c,d	600.00
Family Memorial Gardens	8	rock	b,c	6,000.00
Memorial Rocks				
–small	2	all on rock	b,c	600.00
–medium	4		b,c	800.00
–large	6		b,c	1,000.00
Memorial Trees	2	granite base	d	1,000.00
Weeping Roses	2	granite base	d	1,300.00

PLAQUE SIZES AND FEES:

a: 229mm x 178mm:	200.00	b: 137mm x 102mm:	170.00
c: 178mm x 152mm:	225.00	d: 229mm x 184mm:	250.00

MAUSOLEUM FEES

INDOOR CRYPTS: Perlato marble shutter and Dark Emperador marble trim

Level	Pair (2) \$	True Companion (2) \$	Couch (2) \$
F (highest)	27,000.00	18,000.00	36,000.00
E	33,000.00	25,000.00	44,000.00
D	40,000.00	30,000.00	53,000.00
C	46,500.00	36,000.00	61,500.00

B	46,500.00	36,000.00	61,500.00
A (lowest)	40,000.00	30,000.00	53,000.00
COURTYARD CRYPTS: Rosa Beta granite shutter and Impala Black granite trim			
Level		Single (1)	Pair (2)
		\$	\$
F (highest)		11,000.00	22,000.00
E		13,500.00	27,000.00
D		16,500.00	33,000.00
C		19,500.00	39,000.00
B		19,500.00	39,000.00
A (lowest)		16,500.00	33,000.00
COLONNADE CRYPTS: Rosa Beta granite shutter and Impala Black granite trim			
Level	Single (1)	Pair (2)	True Companion (2)
	\$	\$	\$
F (highest)	9,000.00	18,000.00	12,000.00
E	11,500.00	23,000.00	17,000.00
D	13,500.00	27,000.00	21,000.00
C	16,000.00	32,000.00	24,000.00
B	16,000.00	32,000.00	24,000.00
A (lowest)	13,500.00	27,000.00	21,000.00
GALLERY OF SAINTS: Grigio carnico marble shutter and trim			
Level	Single (1)	Pair (2)	True Companion (2)
	\$	\$	\$
F (highest)	12,000.00	24,000.00	18,000.00
E	15,000.00	30,000.00	22,500.00
D	18,000.00	36,000.00	27,000.00
C	21,000.00	42,000.00	31,500.00
B	21,000.00	42,000.00	31,500.00
A (lowest)	18,000.00	36,000.00	27,000.00

Renewal of right of interment

200.00

DOROTHY COSTA, trustee
MARILYN DUNCAN, trustee
DOUGLAS LONEY, trustee

Cemeteries Act 1958**SCALE OF FEES**

By resolution of the Trust, the following fees, will apply in the Mornington Public Cemetery from the date of approval by the Governor in Council. All other fees are rescinded to the extent which they conflict with this scale.

FEES FOR RIGHT OF BURIAL	\$
Lawn Areas (Plaque & Monumental) (Fees exclude all Plaques and Monumental Costs)	
Children's Area 1.22m x 0.61m	171.00
All Others 2.51m x 1.22m	1,050.00
INTERMENT FEES	
Weekdays	695.00
Saturday Morning or Public Holidays	1,200.00
Child under 5 years of age including stillborn (Children's section only)	152.00
Interment without 10 hours notice	780.00
Cancellation of Order to Interment (if commenced)	175.00
Oversized Interment(Extra charge)	130.00
Additional Depth - each additional 0.30m (Extra charge)	96.00
Interment of Ashes	175.00
Exhumation Fee (when authorised)	1,244.00
RE-OPENING FEES	
Graves Monumental & Lawn Section (No cover)	695.00
Graves Monumental (With cover)	763.00
MISCELLANEOUS CHARGES	
Copy of Certificate of Right of Burial	35.00
CREMATED REMAINS MEMORIALS	
Memorial Walls (can be pre-sold)	
Tenure 50 years from date of purchase (One interment only)	
Initial Purchase	257.00
With Memorial supplied	360.00
Extract of Title	35.00
Memorial Wall Garden (Can be pre-sold)	
Tenure 50 years from date of purchase. (One interment only)	
Initial Purchase	315.00
With Memorial supplied	250.00
Extract of Title	35.00
MEMORIAL GARDEN	
Tenure 50 years from date of purchase (Two Interments)	
Initial Purchase	380.00
With Memorial supplied	363.00
Extract of Title	35.00

LAWN MEMORIALS FOR PURCHASE

Standard plaque 380 x 280 8 lines	257.00
Detachable Plate Plaque	332.00
Additional Plate	93.00
Flower holder	35.00
Installation and Administration fee	275.00

DAVID ALEXANDER RENOUF, trustee

D. G. COLLINGS, trustee

W. A. GOODREM, trustee

Cemeteries Act 1958**SCALE OF FEES**

By resolution of the Trust, the following fees, will apply in the Dromana & Flinders Public Cemetery from the date of approval by the Governor in Council. All other fees are rescinded to the extent which they conflict with this scale.

FEES FOR RIGHT OF BURIAL	\$
All Areas (Plaque & Monumental) (Fees exclude all Plaques and Monumental Costs)	
Dromana Cemetery only 2.51m x 1.22	1,050.00
Flinders Cemetery only 2.51 x 1.22	656.00
INTERMENT FEES	
Weekdays	695.00
Saturday Morning or Public Holidays	1,200.00
Interment without 10 hours notice	780.00
Cancellation of Order to Interment (if commenced)	175.00
Oversized Interment (Extra charge)	130.00
Additional Depth – each additional 0.30m (Extra charge)	96.00
Interment of Ashes	175.00
Exhumation Fee (When authorised)	1,244.00
RE-OPENING FEES	
Graves Monumental & Lawn Section (No cover)	695.00
Graves Monumental (With cover)	763.00
MISCELLANEOUS CHARGES	
Copy of Certificate of Right of Burial	35.00
CREMATED REMAINS MEMORIALS	
Memorial Walls (can be pre-sold)	
Tenure 50 years from date of purchase (One interment only) Initial Purchase	257.00
With Memorial supplied	360.00
Extract of Title	35.00

LAWN MEMORIALS FOR PURCHASE

Standard plaque 380 x 280 8 lines	257.00
Detachable Plate Plaque	332.00
Additional Plate	93.00
Flower holder	35.00
Installation and Administration fee	275.00

DAVID ALEXANDER RENOUF, trustee
D. G. COLLINGS, trustee
W. A. GOODREM, trustee

Cemeteries Act 1958**SCALE OF FEES**

By resolution of the Trust, the following fees will apply in the Timor Public Cemetery from the date of approval by the Governor in Council. All other fees are rescinded to the extent to which they conflict with this scale.

	\$
Land 2.44 m x 1.22 m	165.00
Interment Fee	110.00
Memorials	25.00 or 5%

TERENCE FRANCIS LONG, trustee
CORNELIUS MICHAEL McKINLEY, trustee
AUDREY D. BARTLETT, trustee

Cemeteries Act 1958**SCALE OF FEES**

By resolution of the Trust, the following fees will apply in the Toolamba Public Cemetery from the date of approval by the Governor in Council. All other fees are rescinded to the extent to which they conflict with this scale.

	\$
Land (2.44m x 1.22m)	140.00
Interment Fee	65.00

DAVID S. REA, trustee
RAYMOND H. LUSCOMBE, trustee
ALAN CROSS, trustee

Cemeteries Act 1958**SCALE OF FEES**

By resolution of the Trust, the following fees will apply in the Upper Yarra Public Cemetery from the date of approval by the Governor in Council. All other fees are rescinded to the extent to which they conflict with this scale.

	FEE GST INCLUSIVE
MEMORIAL AREA	\$
Denominational area for approved monumental works	635.00
CHILDREN'S LAWN AREA	
Child grave 1.5 x 1.0 m Allowing one interment	225.00
INTERMENT FEES	
Interment Fees – Lawn and Monumental areas	571.00
Children's Lawn Area	250.00
Ashes placed in private grave	120.00
Interment of Cremated remains into Memorial Ashes Garden	260.00
MISCELLANEOUS CHARGES	
Memorial Fee – Permission to erect, repair or add to any monument	95.00
Exhumation when authorised	1,040.00
Search of records	21.00
Cancellation fee in respect to pre purchased graves	20% of total
PRIVATE GRAVES	
Lawn Area	
Non-Denominational. Bronze plaque memorials only. 2.44 x 1.22m. Allowing two interments	702.00
	ROBERT E. C. BROOKS, trustee
	ELLENA D. BIGGS, trustee
	ROSEMARY CROWLEY, trustee

Dated 6 August 2002
Responsible Minister:
HON JOHN THWAITES MP
Minister for Health

HELEN DOYE
Clerk of the Executive Council

Electricity Industry Act 2000
ORDER UNDER SECTION 13
Order in Council

The Governor in Council, acting under section 13 of the **Electricity Industry Act 2000** (the "Act"), makes the following Order:

1. Objective

The objective of this Order is to regulate the tariffs that Origin Energy may charge prescribed customers.

2. Term

This Order commences on the Completion Date if (but only if) the Completion Date is on or before 1 September 2002. This Order ceases to have effect on 31 December 2002.

3. Definitions

In this Order:

“**CitiPower**” means CitiPower Pty (ACN 064 651 056);

“**Completion Date**” means the date of completion of the purchase by Origin Energy of all or substantially all of the retail electricity business of CitiPower;

“**distribution company**” means, in relation to a supply of electricity from a supply point, the distribution company that is licensed to distribute and supply electricity to and is responsible for the supply point in relation to that supply of electricity;

“**ex-CitiPower domestic or small business customer**” means a person described in clause 4(a) of this Order;

“**ex-CitiPower former franchise customer**” means a person described in clause 4(c) of this Order;

“**licensee**” means a person to whom a licence has been issued under Part 2 of the Act;

“**new CitiPower region domestic or small business customer**” means a person described in clause 4(b) of this Order;

“**Origin Energy**” means Origin Energy Electricity Limited (ACN 071 052 287); and

“**supply point**” means, in relation to supply of electricity to a person, the point at which that supply of electricity last leaves a supply facility owned or operated by a distribution company before being supplied to the person, whether or not the electricity passes through facilities owned or operated by any other person after leaving that point before being so supplied.

4. Prescribed Customers

A person is a prescribed customer for the purpose of the regulation of tariffs under this Order pursuant to section 13 of the Act if the person is a prescribed customer in accordance with any of the following conditions:

- (a) a person is a prescribed customer in respect of a supply point if the person was, immediately prior to the Completion Date, a domestic or small business customer in relation to CitiPower and CitiPower was the local retailer for that supply point within the meaning of the Order made under section 35 of the Act and published in the Government Gazette on 11 January 2002 (but prior to amendment by the Order made under that section and section 27 of the **Interpretation of Legislation Act 1984** and published in the Government Gazette on or about the date of publication of this Order);
- (b) a person is a prescribed customer in respect of a supply point if the distribution company in respect of the supply point is CitiPower, the person is a domestic or small business customer in relation to Origin Energy and Origin Energy is the local retailer for that supply point within the meaning of the Order made under section 35 of the Act and published in the Government Gazette on 11 January 2002 (but as amended by the Order made under that section and section 27 of the **Interpretation of Legislation Act 1984** and published in the Government Gazette on or about the date of publication of this Order); or
- (c) a person is a prescribed customer if the person was a franchise customer of CitiPower immediately before 1 January 2001 and has not entered into a new contract with a licensee which takes effect on or after that date.

5. Tariffs

The tariffs as determined by CitiPower and published in the Government Gazette (No. S9) on 10 January 2002:

- (a) are fixed by this Order with effect from and including the Completion Date as:
 - (i) the maximum tariffs at which Origin Energy may offer to supply and sell electricity to ex-CitiPower domestic or small business customers, or to new CitiPower region domestic or small business customers, for the purposes of section 35 of the Act; and

- (ii) the maximum tariffs at which Origin Energy may supply and sell electricity to ex-CitiPower former franchise customers pursuant to contracts between Origin Energy and such customers arising from the novation of deemed contracts between CitiPower and those customers under section 37 of the Act; and
- (b) apply with effect from and including the Completion Date for the purposes of sections 35 and 37 of the Act.

Dated 6 August 2002
Responsible Minister:
CANDY BROAD MLC
Minister for Energy and Resources

HELEN DOYE
Clerk of the Executive Council

Electricity Industry Act 2000
ORDER UNDER SECTION 35
Order in Council

The Governor in Council, acting under section 27 of the **Interpretation of Legislation Act 1984** and section 35 of the **Electricity Industry Act 2000**, amends the Order in Council made on 11 January 2002 under section 35 of the **Electricity Industry Act 2000** by substituting paragraph (b) of the definition of "local retailer" in clause 3 with the following paragraph:

"(b) Origin Energy Electricity Limited (ACN 071 052 287) where the distribution company in relation to the supply of electricity from the supply point is CitiPower Pty;"

The amendment comes into operation on the date of completion of the purchase by Origin Energy Electricity Limited (ACN 071 052 287) of all or substantially all of the retail electricity business of CitiPower Pty (ACN 064 651 056) ("Completion Date") if (but only if) that date occurs on or before 1 September 2002.

Dated 6 August 2002
Responsible Minister:
CANDY BROAD MLC
Minister for Energy
and Resources

HELEN DOYE
Clerk of the Executive Council

Borrowing and Investment Powers Act 1987
APPROVAL BY THE GOVERNOR IN COUNCIL OF INVESTMENT POWERS FOR NORTH
EAST REGION WATER AUTHORITY

Order in Council

The Governor in Council, pursuant to Section 17A of the **Borrowing and Investment Powers Act 1987** ("the Act") hereby declares that sections 5, 8, 11, 11AA, 12, 14, 20, 20A and 21 of the Act apply to North East Region Water Authority, an "Authority" within the meaning of the **Water Act 1989**.

Dated 6 August 2002
Responsible Minister:
JOHN BRUMBY MP
Treasurer

HELEN DOYE
Clerk of the Executive Council

Crown Land (Reserves) Act 1978

**NOTICE OF INTENTION TO REVOKE
TEMPORARY RESERVATIONS**

The Governor in Council under section 10 of the **Crown Land (Reserves) Act 1978** gives notice of intention to revoke the following temporary reservations:

BARWIDGEE — The temporary reservation by Order in Council of 12 November, 1957 of an area of 4.55 hectares of land in the Parish of Barwidgee as a site for Supply of Gravel. — (Rs 7678).

YARIMA — The temporary reservation by Order in Council of 17 March, 1953 of an area of 1.42 hectares of land in Section C, Parish of Yarima as a site for Public Hall and a Public Park. — (Rs 7075).

YARIMA — The temporary reservation by Order in Council of 27 May, 1980 of an area of 1.214 hectares of land being Crown Allotment 1A, Section C, Parish of Yarima as a site for Public Park. — (Rs 11045).

This Order is effective from the date on which it is published in the Government Gazette.

Dated 6 August 2002

Responsible Minister
SHERRYL GARBUTT
Minister for Environment
and Conservation

HELEN DOYE
Clerk of the Executive Council

Crown Land (Reserves) Act 1978

**NOTICE OF INTENTION TO REVOKE
TEMPORARY RESERVATIONS**

The Governor in Council under section 10 of the **Crown Land (Reserves) Act 1978** gives notice of intention to revoke the following temporary reservations:

CARLTON — The temporary reservation by Order in Council of 11 December, 2001 of an area of 5962 square metres of land being Crown Allotments 13C, 13F and 13G, Section 39, At Carlton, Parish of Jika Jika as a site for Hospital purposes, so far only as the portion containing 78 square metres shown as Crown Allotment 2006, At Carlton, Parish of Jika Jika on Original Plan No. 121798 lodged in the Central Plan Office. — (Rs 6247).

CRANBOURNE — The temporary reservation by Order in Council of 7 July, 1987 of an area of 98.17 hectares of land being Crown Allotment 17A, Parish of Cranbourne as a site for a Racecourse, revoked as to part by Order in Council of 28 November, 2000 so far only as the portion containing 1.731 hectares being Crown Allotment 2002, Parish of Cranbourne as indicated by hatching on plan hereunder. (GP979A) — (Rs 13133).

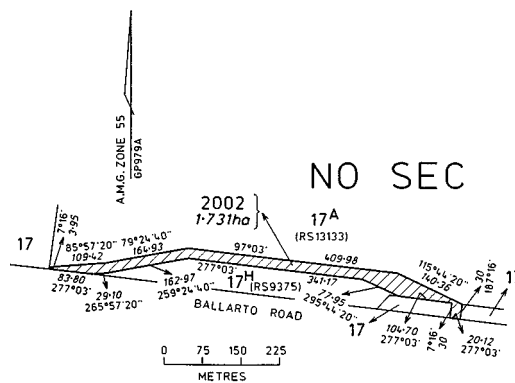

LORNE — The temporary reservation by Order in Council of 3 April, 1984 of an area of 140 square metres of land being Crown Allotment 3A, No Section, Township of Lorne, Parish of Lorne as a site for an Ambulance Station. — (Rs 12594).

WAILL — The temporary reservation by Order in Council of 26 March, 1901 of an area of 2.023 hectares of land in the Parish of Waill (formerly part of subdivision 34 of Mallee allotment 669) as a site for a Night-soil Depot. — (Rs 3152).

This Order is effective from the date on which it is published in the Government Gazette.

Dated 6 August 2002

Responsible Minister
SHERRYL GARBUTT
Minister for Environment
and Conservation

HELEN DOYE
Clerk of the Executive Council

Crown Land (Reserves) Act 1978
**TEMPORARY RESERVATION OF
CROWN LANDS**

The Governor in Council under section 4(1) of the **Crown Land (Reserves) Act 1978** temporarily reserves the following Crown lands

MUNICIPAL DISTRICT OF THE
HINDMARSH SHIRE COUNCIL

TARRANGINNIE — Management of wildlife and preservation of wildlife habitat, 126 hectares, more or less, being Crown Allotment 2002, Parish of Tarranginnie as indicated by hatching on plan hereunder. (GP1040) — (02/2011907).

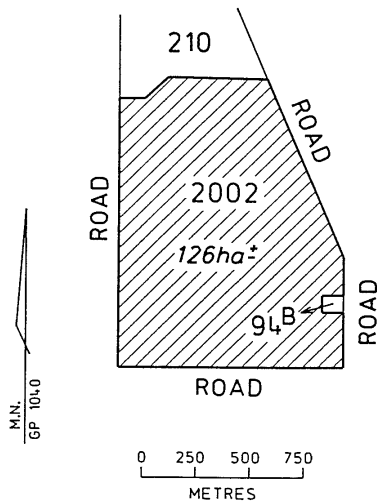

MUNICIPAL DISTRICT OF THE
SWAN HILL RURAL CITY COUNCIL

TUROAR — Conservation of an area of natural interest, 60.69 hectares, being Crown Allotment 2001, Parish of Turoar as indicated by hatching on plan hereunder. (GP1037) — (01/2012154).

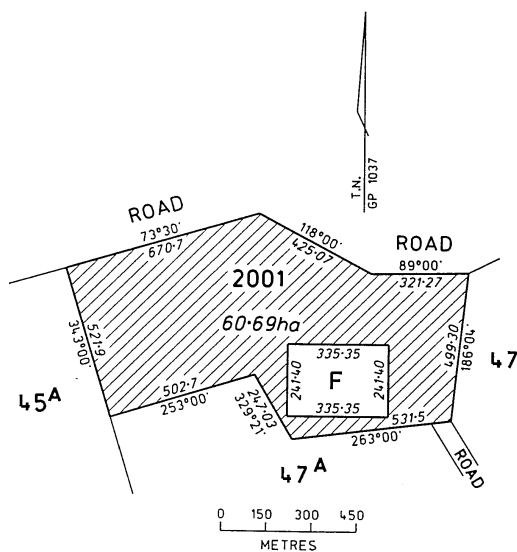

MUNICIPAL DISTRICT OF THE
HOBSONS BAY CITY COUNCIL

WILLIAMSTOWN — Police purposes [Additional purpose] 859 square metres being Crown Allotment 12E, Section 2, Township of Williamstown, Parish of Cut Paw Paw on Original Plan No. 121135 lodged in the Central Plan Office and being part of the land in the Parish of Cut-Paw-Paw and Township of Williamstown temporarily reserved for Public purposes by Order in Council of 24 June, 1997 (vide Special Government Gazette No.75 dated 1 July, 1997 – page 3). — (Rs 37169).

MUNICIPAL DISTRICT OF THE
SWAN HILL RURAL CITY COUNCIL

WOORINEN — Conservation of an area of natural interest, 16.53 hectares being Crown Allotment 2001, Parish of Woorinen as shown on Original Plan No. 121826 lodged in the Central Plan Office. — (01/2012153).

MUNICIPAL DISTRICT OF THE
MELTON SHIRE COUNCIL

YANGARDOOK — Water Supply purposes, total area 13.09 hectares, being Crown Allotments 59K and 59L, Parish of Yangardook as indicated by hatching on plan hereunder. (GP1041) — (2012110).

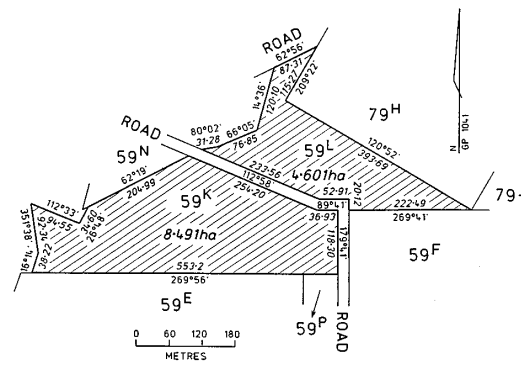

Total area of hatched portions is 13.09ha

This Order is effective from the date on which it is published in the Government Gazette.

Dated 6 August 2002
Responsible Minister
SHERRYL GARBUTT
Minister for Environment
and Conservation

HELEN DOYE
Clerk of the Executive Council

Crown Land (Reserves) Act 1978
 PERMANENT RESERVATION OF
 CROWN LANDS

The Governor in Council under section 4(1) of the **Crown Land (Reserves) Act 1978** permanently reserves the following Crown lands which in his opinion are required for the purposes mentioned:—

MUNICIPAL DISTRICT OF THE
 YARRA RANGES SHIRE COUNCIL

NARREE WORRAN — Conservation of an area of natural interest, total area 7180 square metres, being Crown Allotments 70G2, 70G3 and 70G4, Parish of Narree Worrان as shown on Certified Plan No. 116570-A lodged in the Central Plan Office. — (Rs 11354).

NARREE WORRAN — Conservation of an area of natural interest, area 2.015 hectares being Crown Allotment 2006, Parish of Narree Worrان as indicated by hatching on plan hereunder. (GP1036) — (Rs 10691).

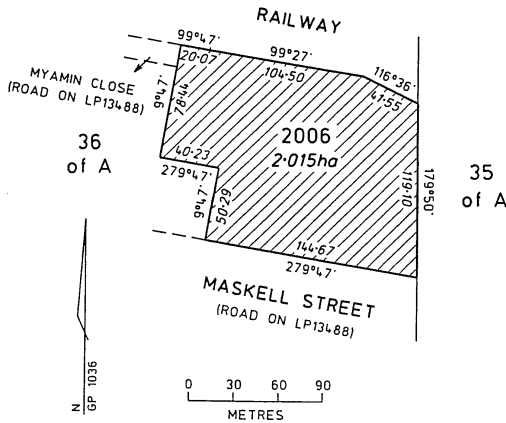

This Order is effective from the date on which it is published in the Government Gazette.

Dated 6 August 2002
 Responsible Minister
 SHERRYL GARBUTT
 Minister for Environment
 and Conservation

HELEN DOYE
 Clerk of the Executive Council

Land Act 1958
 CLOSURE OF UNUSED ROAD

The Governor in Council under section 349 of the **Land Act 1958** and with the concurrence in writing of the municipality in which the road

is situated and the owners of land adjoining the road closes the following unused road:

MUNICIPAL DISTRICT OF THE
 MURRINDINDI SHIRE COUNCIL

YARCK — The road in the Parish of Yarck being Crown Allotment 2002 as indicated by hatching on plan hereunder. (GP906) — (09/P181376).

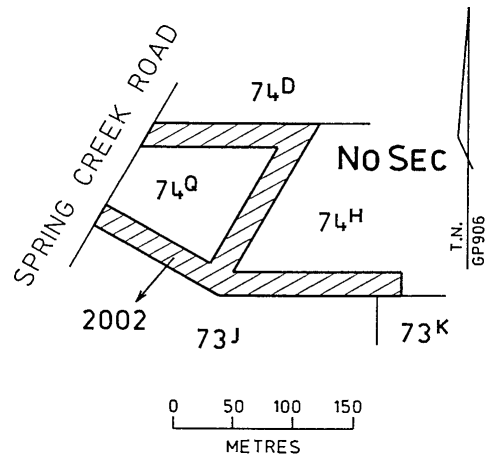

This Order is effective from the date on which it is published in the Government Gazette.

Dated 6 August 2002
 Responsible Minister
 SHERRYL GARBUTT
 Minister for Environment
 and Conservation

HELEN DOYE
 Clerk of the Executive Council

Local Government Act 1989
 ALTERATION OF WARD BOUNDARIES OF
 MACEDON RANGES SHIRE COUNCIL

Order in Council

The Governor in Council hereby directs that:

- a) Under Section 220S (1)(a) of the **Local Government Act 1989**, this Order comes into operation on the day it is published in the Government Gazette; and
- b) Under Section 220Q (k) and (m) of the **Local Government Act 1989**, on the day this Order comes into operation the boundaries of the wards and names of the

wards of the Macedon Ranges Shire Council shall be fixed as described in the Schedule to this Order.

Dated 6 August 2002

Responsible Minister
BOB CAMERON MP

Minister for Local Government

HELEN DOYE

Clerk of the Executive Council

SCHEDULE

Boundaries of the Wards of Macedon Ranges Shire Council

Altered and Redefined

Jacksons Creek Ward

Commencing on the Calder Freeway, at the most northern angle of lot 1 on Plan of Subdivision 402260, being a point on the southern boundary of the Shire; thence southerly by the road forming the western boundaries of land shown on Plans of Subdivision 402660 and 343447 to Couangalt Road; thence westerly by that road to Mount Gisborne Road; thence northerly by that road to Willowbank Road; thence westerly by that road to Aitken Street; thence northerly by that street and Station Road to Saunders Road; thence easterly by that road to Barry Road; thence northerly by that road and a line in continuation to the Melbourne–Murray River Railway; thence easterly and south-easterly by that railway to the southern boundary of the Shire, and thence westerly and southerly by the shire boundary to the point of commencement.

Bullengarook Ward

Commencing on the Calder Freeway at the most northern angle of Lot 1 on Plan of Subdivision 402260 being a point on the southern boundary of the Shire; thence southerly by the road forming the western boundaries of land shown on Plans of Subdivision 402660 and 343447 to Couangalt Road; thence westerly by that road to Mount Gisborne Road; thence northerly by that road to Willowbank Road; thence westerly by that road to Aitken Street; thence northerly by that street and Station Road to Saunders Road; thence easterly by that road to Barry Road; thence northerly by that road and a line in continuation to the Melbourne–Murray River Railway; thence westerly by that railway to Mount Macedon Road; thence southerly by that road to the Calder Freeway; thence south

easterly by that freeway to a point in line with the Quarry Access Road; thence south-westerly by a line, the Quarry Access Road and a line in continuation to the south-eastern shore of Rosslynne Reservoir; thence south-westerly by that shore to a point in line with the Rosslynne Water Treatment Access Road; thence southerly by a line and the Rosslynne Water Treatment Access Road to the Bacchus Marsh–Gisborne Road; thence generally westerly by that road to Waterloo Flat Road; thence north-westerly by that road and Dixon Road to Finger Post Road; thence northerly by that road to Burnt Mill Road; thence westerly by that road to the south-western boundary of the Shire, and thence southerly, easterly and north-westerly by the shire boundary to the point of commencement.

Monegetta Ward

Commencing on the eastern boundary of the Shire at Pattersons Road; thence generally south-westerly by Pattersons Road to Springfield Road; thence south-westerly by that road to Romsey Road; thence westerly by that road to Heskett Boundary Road; thence southerly by that road and south-easterly by Shannons Road to Tunnel Creek Road; thence southerly by that road and Gap Road to Sandy Creek Road; thence south-easterly by that road to the Gisborne–Kilmore Road; thence south-westerly by that road to the Sunbury–Riddells Creek Road; thence southerly by that road to the Melbourne–Murray River Railway; thence easterly and south-easterly by that railway to the southern boundary of the Shire, and thence easterly, northerly and westerly by the shire boundary to the point of commencement.

Campaspe Ward

Commencing on the Kangaroo Creek at Lauriston Road, being a point on the western boundary of the Shire; thence easterly by Lauriston Road to Kyneton Main Road; thence easterly by that road and Piper Street to Mollison Street; thence southerly by that street to High Street; thence south-easterly by that street to Edgecombe Road; thence northerly by that road to a point in line with Beauchamp Street; thence easterly by a line and Pipers Creek Road to Boundary Road; thence southerly by that road to Garth Road; thence westerly by that road and southerly by Mowbrays Road to James Road; thence westerly by that road and north-westerly by the Calder Highway to the

northern boundary of the Parish of Woodend; thence westerly by that boundary to the Campaspe River; thence southerly by that river to the south-eastern angle of Lot 1 on Plan of Subdivision 129603; thence westerly by the southern boundary of that lot, Bourke Lane and further westerly by the southern boundary of the land shown on Title plan 19540 to Little Coliban River; thence southerly by that river to the road forming the southern boundaries of land shown on Plans of Subdivision 404974 and 216066; thence westerly by that road and further westerly by the road forming the southern boundaries of land shown on Plans of Subdivision 209435 and 209436 to the south-eastern angle of Lot 10 on Plan of Subdivision 317941; thence westerly and north-westerly by the southern and southern-western boundaries of that lot to the shore of the Upper Coliban Reservoir; thence generally south-westerly by that shore and the Coliban River to the western boundary of the shire, and thence generally north-westerly and northerly by the shire boundary to the point of commencement.

Mt. William Ward

Commencing on the eastern boundary of the Shire at Pattersons Road; thence generally south-westerly by Pattersons Road to Springfield Road; thence south-westerly by that road to Romsey Road; thence westerly by that road to Potts Road; thence northerly by that road to Colwells Road; thence north-westerly and westerly by that road and further westerly by the Lancefield-Woodend Road to Mowbrays Road; thence northerly by that road to Garth Road; thence easterly by that road and northerly by Boundary Road to Pipers Creek Road; thence easterly by that road and south-easterly by Dohertys Road to the most southern angle of allotment 21, Parish of Cobaw, being a point on the boundary between the Counties of Bourke and Dalhousie; thence north-easterly by that boundary to a point due west of the most western angle of allotment 46, section B; thence east by a line to that angle; thence north-easterly by the north-western boundary of that allotment to Burke and Wills Track; thence south-easterly by that track to the most southern angle of allotment 7B, Parish of Lancefield; thence north-easterly by the south-eastern boundaries of that allotment and allotment 89 to the north-eastern boundary of the Shire, and thence

easterly and south-easterly by the shire boundary to the point of commencement.

Pastoria Ward

Commencing on the Kangaroo Creek at Lauriston Road, being a point on the western boundary of the Shire; thence easterly by Lauriston Road to Kyneton Main Road; thence easterly by that road and Piper Street to Mollison Street; thence southerly by that street to High Street; thence south-easterly by that street to Edgcombe Road; thence northerly by that road to a point in line with Beauchamp Street; thence easterly by a line and Pipers Creek Road and south-easterly by Dohertys Road to the most southern angle of allotment 21 Parish of Cobaw, being a point on the boundary between the Counties of Bourke and Dalhousie; thence north-easterly by that boundary to a point due west of the most western angle of allotment 46, section B; thence east by a line to that angle; thence north-easterly by the north-western boundary of that allotment to Burke and Wills Track; thence south-easterly by that track to the most southern angle of allotment 7B, Parish of Lancefield; thence north-easterly by the south-eastern boundaries of that allotment and allotment 89 to the north-eastern boundary of the Shire, and thence northerly, westerly, southerly and again westerly and southerly by the shire boundary to the point of commencement.

Black Forest Ward

Commencing on the Coliban River at the Tylden-Springhill Road being a point on the western boundary of the Shire; thence generally north-easterly by the Coliban River and the shore of the Upper Coliban Reservoir to a point in line with the south-western boundary of Lot 10 on Plan of Subdivision 317941; thence south-easterly by a line and that boundary and easterly by the southern boundary of that lot to the road forming the southern boundaries of the land shown on Plans of Subdivision 209436 and 209435; thence easterly by that road and further easterly by the road forming the southern boundaries on Plan of Subdivision 216066 and 404974 to the Little Coliban River; thence northerly by that river to the southern boundary of land shown on Title Plan 19540; thence easterly by that boundary to Bourke Lane; thence easterly by that lane and the southern boundary on Plan of Subdivision 129603 to the Campaspe

River; thence southerly by that river to the Tylden–Woodend Road; thence south-easterly by that road to the Melbourne–Murray River Railway; thence further south-easterly by that railway to Mount Macedon Road; thence southerly by that road to the Calder Freeway; thence south easterly by that freeway to a point in line with the Quarry Access Road; thence south-westerly by a line, the Quarry Access Road and a line in continuation to the south-eastern shore of the Rosslynne Reservoir; thence south-westerly by that shore to a point in line with the Rosslynne Water Treatment Access Road; thence southerly by a line and the Rosslynne Water Treatment Access Road to the Bacchus Marsh–Gisborne Road; thence generally westerly by that road to Waterloo Flat Road; thence north-westerly by that road and Dixon Road to Finger Post Road; thence northerly by that road to Burnt Mill Road; thence westerly by that road to the south-western boundary of the Shire, and thence south-westerly, westerly and generally northerly by the shire boundary to the point of commencement.

Hanging Rock Ward

Commencing on the Melbourne–Murray River Railway at McBean Avenue; thence north-easterly by McBean Avenue to Bent Street; thence northerly by that street to Honour Avenue; thence easterly by that avenue to Waterfalls Road; thence northerly by that road and north-easterly by The Governors Drive to Douglas Road; thence easterly by that road to Alton Road; thence generally northerly by that road and Clyde Track to Cameron Drive; thence generally easterly by that drive to Mount Macedon Road; thence northerly by that road to Lions Head Road; thence easterly by that road to the western boundary of the Parish of Kerrie; thence generally easterly and generally northerly by that boundary to the south-western angle of lot 2 on Plan of Subdivision 217063; thence easterly by the southern boundaries of that lot and allotment 214, Parish of Kerrie to the junction of Shannons Road with Heskett Boundary Road; thence northerly by Heskett Boundary Road to Romsey Road; thence north-westerly by that road to Potts Road; thence northerly by that road to Colwells Road; thence north-westerly by that road and the Lancefield–Woodend Road to Mowbrays Road; thence northerly by that road to James Road;

thence westerly by that road and north-westerly the Calder Highway to the northern boundary of the Parish of Woodend; thence westerly by that boundary to the Campaspe River; thence southerly by that river to the Tylden–Woodend Road; thence south-easterly by that road to the Melbourne–Murray River Railway thence south-easterly by that railway to the point of commencement.

Barringo Ward

Commencing on the Melbourne–Murray River Railway at McBean Avenue; thence north-easterly by McBean Avenue to Bent Street; thence northerly by that street to Honour Avenue; thence easterly by that avenue to Waterfalls Road; thence northerly by that road and north-easterly by The Governors Drive to Douglas Road; thence easterly by that road to Alton Road; thence generally northerly by that road and Clyde Track to Cameron Drive; thence generally easterly by that drive to Mount Macedon Road; thence northerly by that road to Lions Head Road; thence easterly by that road to the western boundary of the Parish of Kerrie; thence generally easterly and generally northerly by that boundary to the south-western angle of lot 2 on Plan Subdivision 217063; thence easterly by the southern boundaries of that lot and allotment 214, Parish of Kerrie to the junction of Shannons Road with Heskett Boundary Road; thence south-easterly by Shannons Road to Tunnel Creek Road; thence southerly by that road and Gap Road to Sandy Creek Road; thence south-easterly by that road to the Gisborne–Kilmore Road; thence south-westerly by that road to the Sunbury–Riddells Creek Road; thence southerly by that road to the Melbourne–Murray River Railway, and thence westerly and north-westerly by that railway to the point of commencement.

Local Government Act 1989

ALTERATION OF WARD BOUNDARIES OF GREATER DANDENONG CITY COUNCIL

Order in Council

The Governor in Council hereby directs that:

- a) Under Section 220S (1)(a) of the **Local Government Act 1989**, this Order comes into operation on the day it is published in the Government Gazette; and

b) Under Section 220Q (k) and (m) of the **Local Government Act 1989**, on the day this Order comes into operation the boundaries of the wards and names of the wards of the Greater Dandenong City Council shall be fixed as described in the Schedule to this Order.

Dated 6 August 2002

Responsible Minister
BOB CAMERON MP
Minister for Local Government

HELEN DOYE
Clerk of the Executive Council
SCHEDULE

**Boundaries of the Wards of
Greater Dandenong City Council**

Altered and Redefined

Springvale North Ward

Commencing on the Melbourne and Dandenong Railway at Westall Road being a point on the western boundary of the City; thence south-easterly by the Melbourne and Dandenong Railway to Heatherton Road; thence easterly by that road to Dunblane Road; northerly and north-easterly by that road to Princes Highway; thence north-westerly by that highway to the city boundary, and thence north-westerly and southerly by the city boundary to the point of commencement.

Noble Park North Ward

Commencing on Police Road at the Scoresby Freeway Reservation being a point on the northern boundary of the City; thence southerly by the Scoresby Freeway Reservation to Halton Road; thence westerly by that road to Elonera Road; thence southerly and south-westerly by that road to Chandler Road; thence southerly by that road to Heatherton Road; thence westerly by that road to Dunblane Road; thence northerly and north-easterly by that road to the Princes Highway; thence north-westerly by that highway to the northern boundary of the City at Police Road, and thence easterly by the city boundary to the point of commencement.

Dandenong North Ward

Commencing on the Dandenong Creek at Heatherton Road being a point on the eastern boundary of the City; thence westerly by Heatherton Road to Stud Road; thence northerly

by that road to a point in line with Carlton Road; thence westerly by a line and Carlton Road to Devira Street; thence southerly by that street to Sylvia Street; thence westerly by that street, Kandra Street and the south-western boundary of Lot 8 Plan of Subdivision 110823 to the Scoresby Freeway Reservation; thence northerly by that freeway reservation to the northern boundary of the City, and thence easterly and south-easterly by the city boundary to the point of commencement.

Lyndale Ward

Commencing at the intersection of Stud Road and Heatherton Road; thence northerly by Stud road to a point in line with Carlton Road; thence westerly by a line and Carlton Road to Devira Street; thence southerly by that street to Sylvia Street; thence westerly by that street, Kandra Street and the south-western boundary of Lot 8 Plan of Subdivision 110823 to the Scoresby Freeway Reservation; thence northerly by that freeway reservation to Halton Road; thence westerly by that road to Elonera Road; thence southerly and south-westerly by that road to the Princes Highway; thence south-easterly by that highway to David Street; thence easterly by that street to James Street; thence northerly by that street to Ash Grove; thence easterly by that grove and northerly by Woodlee Street to Sheales Street; thence easterly by that street and southerly by Cleeland Street to Oswald Street; thence easterly by that street to Stud Road; thence northerly by that road to the point of commencement.

Dandenong Ward

Commencing on Springvale Road at Pillars Road being a point on the western boundary of the City; thence south-easterly by Pillars Road to Perry Road; thence north-westerly by that road to Island Road; thence north-easterly by that road and northerly by Chandler Road to Cheltenham Road; thence north-easterly by that road to Bridge Road; thence northerly by that road to Popes Road; thence easterly by a line in continuation of Popes Road to Mile Creek; thence northerly by that creek to Yarraman Creek; thence north-easterly by that creek to the Melbourne and Dandenong Railway; thence south-easterly by that railway to Cheltenham Road; thence north-easterly by that road to Foster Street; thence easterly by that street to Lonsdale Street; thence northerly by that street

to Clow Street; thence easterly by that street to Stud Road; thence northerly by that road to Ann Street; thence easterly by that street and northerly by Ross Street to David Street; thence easterly by that street and a line in continuation to Dandenong Creek being a point on the eastern boundary of the City; thence southerly, by the eastern boundary of the City to Thompson Road; thence westerly by that road to the Mornington Peninsula Freeway, and thence northerly by that freeway and Springvale Road to the point of commencement.

Keysborough South Ward

Commencing on Springvale Road at Pillars Road being a point on the western boundary of the City; thence south-easterly by Pillars Road to Perry Road; thence north-westerly by that road to Island Road; thence north-easterly by that road and northerly by Chandler Road to Cheltenham Road; thence westerly by that road to Corrigan Road; thence northerly by that road to Harold Road; thence westerly by that road and southerly by Springvale Road to the western boundary of the City, and thence southerly by the city boundary to the point of commencement.

Keysborough Ward

Commencing on Cheltenham Road at Corrigan Road; thence easterly and north-easterly by Cheltenham Road to Bridge Road; thence northerly by that road and westerly by Popes Road to Chandler Road; thence southerly by that road to Isaac Road; thence westerly by that road and northerly by Bloomfield Road to Moodemere Street; thence westerly by that street and southerly by Corrigan Road to the point of commencement.

Noble Park Ward

Commencing on the Princes Highway at Chandler Road; thence south-easterly by the Princes Highway to the Scoresby Freeway Reservation; thence southerly by that freeway reservation to the Melbourne and Dandenong Railway; thence south-easterly by that railway to the Yarraman Creek; thence south-westerly by that creek and Mile Creek to a point in line with Popes Road; thence westerly by a line and Popes Road to Chandler Road; thence southerly by that road to Isaac Road; thence westerly by that road and northerly by Bloomfield Road to Moodemere Street; thence westerly by that

street and northerly by Corrigan Road to the Melbourne and Dandenong Railway; thence south-easterly by that railway to Heatherton Road; thence easterly by that road to Chandler Road, and thence northerly by that road to the point of commencement.

Springvale South Ward

Commencing on Heatherton Road at Westall Road being a point on the western boundary of the City; thence easterly by Heatherton Road to Corrigan Road; thence southerly by that road to Harold Road; thence westerly by that road and southerly by Springvale Road to the western boundary of the City at Westall Road Extension; thence north-westerly by that road to Spring Road; thence north-westerly by the proposed Dingley Freeway reservation to Tootal Road; thence north-easterly by that road to Heatherton Road, and thence easterly by that road to the point of commencement.

Springvale Central Ward

Commencing on the Melbourne and Dandenong Railway at Westall Road being a point on the western boundary of the City; thence south-easterly by the Melbourne and Dandenong Railway to Corrigan Road; thence southerly by that road to Heatherton Road; thence westerly by that road to Westall Road being a point on the western boundary of the City, and thence northerly by the city boundary to the point of commencement.

Cleeland Ward

Commencing on the Dandenong Creek at Heatherton Road being a point on the eastern boundary of the City; thence westerly by Heatherton Road to Stud Road; thence southerly by that road to Oswald Street; thence westerly by that street and northerly by Cleeland Street to Sheales Street; thence westerly by that street and southerly by Woodlee Street to Ash Grove; thence westerly by that grove and southerly by James Street to David Street; thence westerly by that street to the Princes Highway; thence north-westerly by that highway to the Scoresby Freeway Reservation; thence southerly by that freeway reservation to the Melbourne and Dandenong Railway; thence south-easterly by that railway to Cheltenham Road; thence north-easterly by that road to Foster Street; thence easterly by that street to Lonsdale Street; thence northerly by that street to Clow Street;

thence easterly by that street to Stud Road; thence northerly by that road to Ann Street; thence easterly by that street and northerly by Ross Street to David Street; thence easterly by that street and a line in continuation to Dandenong Creek being a point on the eastern boundary of the City, and thence northerly by the city boundary to the point of commencement.

**Project Development and
Construction Management Act 1994**

**NOMINATION OF PROJECTS TO BE
PROJECTS TO WHICH THE ACT APPLIES**

Order in Council

Under Section 6 of the **Project Development and Construction Management Act 1994** ("the Act") the Governor in Council declares the following development or proposed development to be a project to which the Act applies:

- Austin & Repatriation Medical Centre and Mercy Hospital for Women Project (AR/M Project)

AND in accordance with Section 7 of the Act, to specify:

- (a) that the Minister for Major Projects is to be responsible for the nominated project;
- (b) that the Secretary to the Department of Infrastructure, being a body corporate established under Section 35 of the Act, is to be the facilitating agency for the nominated project.

Dated 6 August 2002

Responsible Minister
STEVE BRACKS
Premier

HELEN DOYE
Clerk of the Executive Council

This page left blank intentionally

**SUBORDINATE LEGISLATION ACT 1994
NOTICE OF MAKING OF STATUTORY
RULES**

Notice is hereby given under Section 17 (2) of the **Subordinate Legislation Act 1994** of the making of the following Statutory Rules:

63. *Statutory Rule:* Fisheries (Commercial Licences) Regulations 2002
Authorising Act: Fisheries Act 1995
Date of making: 6 August 2002
64. *Statutory Rule:* Subordinate Legislation (Pharmacists Regulations 1992 – Extension of Operation) Regulations 2002
Authorising Act: Subordinate Legislation Act 1994
Date of making: 6 August 2002

As from 1 April 2002, the pricing structure for the Victoria Government Gazette and Victorian Government Legislation will be as follows.

Retail price will vary according to the number of pages in each special or periodical gazette. The table below sets out the prices that apply.

<i>Price Code</i>	<i>No. of Pages (Including cover and blank pages)</i>	<i>Price*</i>
A	1–16	\$3.65
B	17–32	\$5.40
C	33–48	\$7.40
D	49–96	\$11.50
E	97–144	\$14.85
F	145–192	\$17.55
G	193–240	\$20.25
H	241–288	\$21.55
I	289–352	\$24.25
J	353–416	\$28.35
K	417–480	\$32.35
L	481–544	\$37.75
M	545–608	\$43.15
N	609–672	\$48.55
O	673–736	\$53.90
P	737–800	\$59.30

**All Prices Include GST*

ADVERTISERS PLEASE NOTE

As from 8 August 2002

The last Special Gazette was No. 137 dated 7 August 2002

The last Periodical Gazette was No. 1 dated 4 June 2002

CONTENTS

	Page
Estates of Deceased Persons	1917
Government and Outer Budget Sector	
Agencies Notices	2163
Orders in Council	2191
Acts — Cemeteries; Electricity Industry; Borrowing and Investment Powers; Crown Land (Reserves); Land; Local Government; Project Development and Construction Management	
Private Advertisements	1917
Proclamations	2162

The Victoria Government Gazette is published by The Craftsman Press Pty. Ltd. with the authority of the Government Printer for the State of Victoria
© State of Victoria 2002

ISSN 0819-5471

This publication is copyright. No parts may be reproduced by any process except in accordance with the provisions of the Copyright Act.

Products and services advertised in this publication are not endorsed by The Craftsman Press Pty. Ltd. or the State of Victoria and neither of them accepts any responsibility for the content or the quality of reproduction. The Craftsman Press Pty. Ltd. reserves the right to reject any advertising material it considers unsuitable for government publication.

Address all enquiries to the Government Printer for the State of Victoria
Government Information and Communications Branch
Department of Premier and Cabinet
Level 3, 356 Collins Street
Melbourne 3000
Victoria Australia

RETAIL SALES

Information Victoria Bookshop
356 Collins Street Melbourne 3000.
Telephone enquiries 1300 366 356

City Graphics
Level 1, 520 Bourke Street
Melbourne 3000
Telephone enquiries (03) 9600 0977

Recommended Retail Price \$1.85 (includes GST)

Government and Outer Budget Sector Agencies please note:
STYLE REQUIREMENTS.

To ensure that material received can be reproduced, and that errors are minimised, the following guidelines are to be observed when submitting material by fax.

Fax resolution:

Material sent by fax should be transmitted using Fine Resolution (200 dots per inch by 200 dpi).

Font size:

Use 12 point (10 pitch) or larger.

Font Style:

Clear plain font styles, such as Helvetica, should be used.

Graphics:

Line drawings should be transmitted as large as possible to ensure clarity. Drawings up to A4 size sent by fax using Fine Resolution provide a good quality for reproduction.

Avoid:

Italics, underlining and full justification.

Ensure document is square when sending as documents that are sent skewed are difficult to read and process.

ISSN 0819-5471

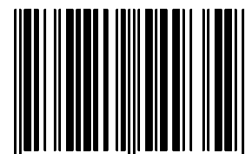

9 770819 549359