



Victoria Government Gazette

No. G 19 Thursday 8 May 2003

GENERAL

GENERAL AND PERIODICAL GAZETTE

Copy to: Gazette Officer
The Craftsman Press Pty. Ltd.
125 Highbury Road,
Burwood Vic 3125
Telephone: (03) 9926 1233
Facsimile: (03) 9926 1292
DX: 32510 Burwood
Email: gazette@craftpress.com.au

Advertising Rates and Payment

All prices include GST

Private Notices

Payment must be received in advance with advertisement details.

33 cents per word – Full page \$198.00.

Additional costs must be included in prepayment if a copy of the gazette is required. Copy Prices – Page \$1.65 – Gazette \$3.52 – Certified copy of Gazette \$3.85 (all prices include postage). *Cheques should be made payable to The Craftsman Press Pty. Ltd.*

Government and Outer Budget Sector Agencies Notices

Not required to prepay.

Advertisements may be faxed or sent via email with a cover sheet, marked to the attention of the Gazette Officer. Floppy Disks (Mac & PC) can also be accepted.

Costs can be calculated on the following basis:

Per Line	Typeset
Single column	\$1.71
Double column	\$3.41
Full Page	\$71.28

The Craftsman Press is pleased to offer a series of discounts from the typesetting costs.

1. Copy supplied on disk.
2. Copy supplied via email.
3. Artwork for forms and other material which require exact reproduction.

1. Copy supplied on disk.

Where a disk is supplied and there is minimum alteration required, **30% off.**

Where a disk is supplied requiring extraneous matter stripped out and styles applied, **20% off.**

2. Copy supplied via email.

Where a notice is sent via email and there is minimum alteration required, **25% off.**

Where email is supplied requiring extraneous matter stripped out and styles applied, **15% off.**

3. Artwork for forms and other material which requires exact reproduction.

Scanning and sizing of artwork for forms, to be reproduced in page format, **35% off.**

Copy Deadline for General Gazette

9.30 a.m. Monday – (Private Notices)

9.30 a.m. Tuesday – (Government and Outer Budget Sector Agencies Notices)

Advertisers should note:

- Late copy received at The Craftsman Press Pty. Ltd. after deadlines will be placed in the following issue of VGG, irrespective of any date/s mentioned in the copy (unless otherwise advised).
- Late withdrawal of advertisements (after client approval, before printing) will incur 50 per cent of the full advertising rate to cover typesetting, layout and proofreading costs.
- Proofs will be supplied only when requested or at the direction of the Gazette Officer.
- No additions or amendments to material for publications will be accepted by telephone.
- Orders in Council may be lodged prior to receiving assent with the Governor's or Clerk's signature. They will only be published once approved and signed.
- Accounts over 90 days will be issued with a letter of demand.
- Government and Outer Budget Sector Agencies please note: *See style requirements on back page.*

SPECIAL GAZETTES

Copy to: Gazette Officer
The Craftsman Press Pty. Ltd.
125 Highbury Road
Burwood Vic 3125
Telephone: (03) 9926 1233
Facsimile: (03) 9926 1292
Email: gazette@craftpress.com.au

Advertising Rates and Payment

Private Notices

Full Page \$396.00

Payment must be received in advance with notice details.

Government and Outer Budget Sector Agencies Notices

Full Page
Typeset
\$106.92

Note:

The after hours numbers for Special Gazettes are:

Telephone: **0419 327 321**
0419 325 882
0417 391 171

SUBSCRIPTIONS AND RETAIL SALES

Copies of the *Victoria Government Gazette* can be purchased from The Craftsman Press Pty. Ltd. by subscription.

The *Victoria Government Gazette*

General and Special – \$198.00 each year

General, Special and Periodical – \$264.00 each year

Periodical – \$132.00 each year

Subscriptions are payable in advance and accepted for a period of one year. All subscriptions are on a firm basis and refunds will not be given.

All payments should be made payable to The Craftsman Press Pty. Ltd.

Subscription enquiries:

The Craftsman Press Pty. Ltd.
125 Highbury Road, Burwood Vic 3125

INDEX TO PRIVATE ADVERTISERS

A

A.B. Natoli Pty906

B

Brian V. O'Haire906

D

De Marco & Co.906

Dwyer Mahon & Robertson906

F

Featherby's906

G

G. W. H. Chambers906

Gray Friend & Long907

Gullaci & Gullaci907

H

Harris Lieberman Boyd907

Hassall & Byrne907

Henty Jepson & Kelly907

Home Wilkinson Lowry908

L

Lawson Hughes Reservoir908

Littleton Hackford908

M

Maddocks908

Mason Sier Turnbull908

McDonald, Slater & Lay908

McKean & Park909

P

Power & Bennett909

T

T. J. Mulvany & Co.909

V

Verna A. Cook909

Advertisers Please Note

All advertisers please note that from Thursday, 1 May 2003 the following rates apply:

SERVICE FEES

Private Notices (Pre-paid)	Rate	Rate incl. GST
Cost per word	\$0.30	\$0.33
Cost per faxed copy of page containing client's notice	\$1.50	\$1.65
Cost per copy of Gazette containing client's notice plus postage	\$3.20	\$3.52

Unclaimed Moneys (Pre-paid)	Rate	Rate incl. GST
Cost per column centimetre	\$9.30	\$10.32
Cost per full page	\$171.50	\$188.65

Government and Outer Budget Sector Agencies Notices	Rate	Rate incl. GST
Note: 15% discount for emailed copy		
Cost per column centimetre	\$4.65	\$5.12
Cost per half page	\$33.95	\$37.35
Cost per full page	\$64.80	\$71.28

Special Gazettes

Special Gazettes attract a 50% surcharge on the above rates.

Subscription, Fees and Discounts (incl. GST)

General, Special and Periodical	\$264.00 per annum
General and Special	\$198.00 " "
Periodical	\$132.00 " "

All other charges remain unchanged until further notice.

PRIVATE ADVERTISEMENTS

Partnership Act 1958**NOTICE OF RETIREMENT**

Notice is hereby given that the partnership heretofore subsisting between Lewis Rowland Binks, Kevin Nigel Bertram and Portia Bertram carrying on business of timber moulding at Shed 13, Caravan Street, Wendouree under the firm of TooBees, has been dissolved as from 1 May 2003 so far as concerns the said Mr Binks who retires from the said firm.

Dated 28 April 2003.

GREGORY WILLIAM DYNON, late of 46 Alpha Street, North Balwyn, Victoria, general practitioner, deceased. Creditors, next-of-kin and others having claims in respect of the estate of the abovenamed deceased, who died on 8 December 2002, are required by Lynne Kathryn Dynon, the executor of the deceased's Will, to send particulars of their claim to the said executor care of the undermentioned solicitors by a date not later than two months from the date of publication hereof, after which date she will convey or distribute the assets having regard only to the claims of which she then has notice.

A. B. NATOLI PTY, solicitors,
24 Cotham Road, Kew 3101.

TEMPLE JAMES SIRES, deceased.

Creditors, next-of-kin and others having claims in respect of the estate of the abovenamed deceased, who died on 15 February 2001, are required by Kerry Maree Webb of Unit 4/64A Second Avenue, St. Peters, South Australia, the personal representative of the deceased, to send particulars to her c/- the undermentioned solicitor by 7 July 2003 after which date she may convey or distribute the assets having regard only to the claims of which she then has notice.

BRIAN V. O'HAIRE, solicitor,
15-17 Perrin Street,
PO Box 295, Robinvale, Vic. 3549.
Telephone: (03) 5026 1980.
Facsimile: (03) 5026 1620.

Re: SARA ZUCCARELLI, late of 138 Greenvale Drive, Greenvale, Victoria, deceased. Creditors, next-of-kin and others having claims in respect of the estate of the deceased, who died on 3 January 2003, are required by the trustee, Tommaso Zuccarelli of 138 Greenvale Drive, Greenvale, Victoria, to send particulars to the trustee within 60 days from the publication hereof, after which date the trustee may convey or distribute the assets, having regard only to the claims of which the trustee has notice.

DE MARCO & CO., solicitors,
209 Glenroy Road, Glenroy 3046.

Re: Estate of COLIN BYRON GUTHRIE, deceased. Creditors, next-of-kin or others having claims in respect of the estate of COLIN BYRON GUTHRIE, late of 1 St Arnaud Road, Wedderburn, in the State of Victoria, farmer, deceased, who died on 20 August 1988, are to send particulars of their claim to the administrator care of the undermentioned legal practitioners by 16 August 2003 after which the administrator will distribute the assets having regard only to the claims of which she then has notice.

DWYER MAHON & ROBERTSON,
legal practitioners,
Beveridge Dome,
194-208 Beveridge Street, Swan Hill.

Creditors, next-of-kin or others having claims in respect of the estate of GUENTER HARIG, late of 20-24 Astbury Street, Avoca, in the State of Victoria, deceased, who died on 27 July 2002, are to send particulars of their claims to the executor care of the undermentioned solicitors by 6 July 2003 after which date the executor will distribute the assets having regard only to the claims of which he then has notice.

FEATHERBY'S, solicitors,
1043A Point Nepean Road, Rosebud 3939.

JEAN ELIZABETH WHIFFIN, late of 7 Silverleaves Avenue, Cowes, pharmacist. Creditors, next-of-kin and others having claims

in respect of the estate of the deceased, who died on 26 March 2003, are required by the trustee, care of G.W.H. Chambers, solicitor of 338 Charman Road, Cheltenham, to send particulars to him by 9 July 2003 after which date the trustee may convey or distribute the assets, having regard only to the claims of which he then has notice.

G.W.H. CHAMBERS, solicitor,
338 Charman Road, Cheltenham 3192.

LYDIA PEHEIM, late of 87 Wilson Street, Cheltenham. Creditors, next-of-kin and others having claims in respect of the estate of the deceased, who died on 14 March 2003, are required by the trustees, care of G.W.H. Chambers, solicitor of 338 Charman Road, Cheltenham, to send particulars to him by 9 July 2003 after which date the trustees may convey or distribute the assets having regard only to the claims of which they then have notice.

G.W.H. CHAMBERS, solicitor,
338 Charman Road, Cheltenham 3192.

MARIA WARENYCIA, late of 45 Charles Street, Warragul, widow, deceased. Creditors, next-of-kin and others having claims in respect of the estate of the deceased, who died on 10 March 2003, are required by the trustee, Gerry Warenycia to send particulars of their claims to him care of the undersigned solicitors by 8 July 2003 after which date the trustee may convey or distribute the assets having regard only to the claims of which he then has notice.

GRAY FRIEND & LONG, solicitors,
70 Queen Street, Warragul 3820.

FRANCESCO LONGO, late of Essendon Aged Care Facility, 10 Fletcher Street, Essendon 3040, in the State of Victoria, formerly of 143 Victoria Street, Flemington 3031, in the said State, pensioner, deceased. Creditors, next-of-kin and others having claims in respect of the estate of the abovenamed deceased, who died on 30 January 2003, are required by Francesco Ganino, the executor of the said estate, to send particulars by 7 July 2003, to his solicitors, Gullaci & Gullaci of 158 Bell Street, Coburg, after which date the executor may

convey or distribute the assets having regard only to the claims of which he then has notice.

Dated 28 April 2003

GULLACI & GULLACI, solicitors,
158 Bell Street, Coburg, Victoria 3058.

Re: PATRICK McFARLAND, late of Chiltern Bush Nursing Hospital, 11 Main Street, Chiltern, Victoria, but formerly of 6 Mirabelle Court, Wodonga, retired farmer, deceased. Creditors, next-of-kin and others having claims in respect of the estate of the deceased, who died on 21 August 2002, are required by the trustees, David John Iverson of 18 Moonya Drive, Wodonga, Victoria, solicitor and Francis Charles McFarland of RMB 8520, Bethanga Vale, Bethanga, Victoria, farmer, to send particulars to the trustees by 8 July 2003 after which date the trustees may convey or distribute the assets, having regard only to the claims of which the trustees have notice.

HARRIS LIEBERMAN BOYD, solicitors,
7 Thomas Mitchell Drive, Wodonga 3690.

Creditors, next-of-kin and others having claims in respect of the estate of GEORGE HENRY JOOSTEN, late of Westhaven Community Care, 50 Pickett Street, Footscray, Victoria, who died on 10 February 2003, are required by the executors, Ronald George Joosten of 27 Kokoda Road, Williamstown, Victoria and Jennifer Anne Greenhalgh of 10 Vesper Street, Richmond, Victoria, to send detailed particulars of their claims to the said executors c/- Hassall & Byrne, solicitors of 250 Charman Road, Cheltenham 3192 by 8 July 2003 after which date they will proceed to distribute the estate having regard only to the claims of which they then have notice.

HASSALL & BYRNE, solicitors,
250 Charman Road, Cheltenham 3192.

BEATRICE MARIE HELLSTROM, late of Broughtonlea Nursing Home, 9-17 Broughton Road, Surrey Hills, Victoria, widow, deceased. Creditors, next-of-kin and others having claims in respect of the estate of the abovenamed deceased, who died on 11 February 2003, are required by Michael Bernhard Hellstrom, Lesley Denise Young and Trust Company of

Australia Limited (formerly the Union-Fidelity Trust Company of Australia Limited), the executors of the said estate, to send particulars by 15 July 2003 to Trust Company of Australia Limited of 151 Rathdowne Street, Carlton South, in the said State, after which date the executors may convey or distribute the assets, having regard to the claims of which they then have notice.

HENTY JEPSON & KELLY, solicitors,
Level 4, 84 William Street, Melbourne 3000.

Creditors, next-of-kin and others having claims in respect of the estate of FAYE REITA RUTH GRAY (also known as Ruth Reita Faye Gray, Faye Gray, Reita Gray and Ruth Reita Gray), late of 156 The Boulevard, East Ivanhoe, in the State of Victoria, retired, deceased, who died on 13 February 2003, are required by the personal representatives of the deceased, Dianne Flynn and Shaun Flynn, promotion manager and director respectively, to send particulars to them care of the undermentioned solicitors by 7 July 2003 after which date they will distribute the estate having regard only to the claims of which they then have notice.

HOME WILKINSON LOWRY, solicitors,
Level 1, 535 Bourke Street, Melbourne 3000.

HAROLD FRANCIS PERKINS, late of 7 Munro Street, Lalor, retired police officer, deceased. Creditors, next-of-kin and others having claims in respect of the estate of the deceased, who died on 14 October 2002, are required by John Arthur Perkins of 140 Scrubby Creek Road, Humevale, the executor and trustee of the deceased, to send particulars of their claims to the said executor and trustee by 11 July 2003 after which date he will convey or distribute the assets of the deceased having regard only to the claims of which he then has notice.

LAWSON HUGHES RESERVOIR, solicitors,
309-311 Spring Street, Reservoir 3073.

Creditors, next-of-kin and others having claims in respect of the estate of COLIN RICHARD MITCHELL, late of "Oakbank", Toongabbie, Victoria, retired farmer, deceased, who died on 4 April 2003, are to send their

claims to the trustees, Carolyn Margaret Pelchen of 28 Langford Street, Morwell, Victoria and Susanne Leah Burgin of 57 King Street, Hamilton, Victoria, care of the belowmentioned solicitors by 8 July 2003 after which date they will distribute the assets of the deceased having regard only to the claims of which they then have notice.

LITTLETON HACKFORD, solicitors,
Law Chambers,
115 Hotham Street, Traralgon, Vic. 3844.

Re: PATRICIA EVELYN NORMAN, late of 6492 Brooklyn Bay Road, Keystone Heights, Florida, USA, housewife, deceased. Creditors, next-of-kin and others having claims in respect of the estate of the deceased, who died on 15 May 2002, are required by the trustee, Gregory Wayne Norman of 2463 County Dock Road, Jacksonville, USA, senior custom service engineer, to send particulars to the trustee by 8 July 2003 after which date the trustee may convey or distribute the assets, having regard only to the claims of which the trustee has notice.

MADDOCKS, lawyers,
140 William Street, Melbourne 3000.

Estate PATRICIA KATHLEEN MUNT, deceased. Creditors, next-of-kin and others having claims in respect of the estate of PATRICIA KATHLEEN MUNT, deceased, late of 5 Ashwood Drive, Nunawading, Victoria, who died on 11 December 2002, are required to send particulars of their claims to the administrator, Suzanne Catherine Wakeham of 1/296 Springvale Road, Forest Hill, Victoria, care of the undermentioned solicitors by 8 July 2003 after which date the administrator will distribute the assets having regard only to the claims of which she then has notice.

MASON SIER TURNBULL, solicitors,
315 Ferntree Gully Road, Mount Waverley 3149.

HAROLD LINDSAY YOUNG, late of Unit 1, 7 High Street, Mordialloc, in the State of Victoria, investor, deceased. Creditors, next-of-kin and others having claims in respect of the estate of the abovenamed deceased, who died on 26 July 2001, are required by Gregory

Lee Broderick and Colin Gordon Young, the executors of the said estate, to send particulars of their claims by 12 July 2003 to their solicitors, McDonald, Slater & Lay, of 136 Balcombe Road, Mentone, after which date the executors may convey or distribute the assets, having regard only to the claims of which they then have notice.

McDONALD, SLATER & LAY,
legal practitioners,
136 Balcombe Road, Mentone, Victoria 3194.

Re: COLIN STANLEY FRASER, late of 54 Middle Crescent, Brighton, Victoria, deceased. Creditors, next-of-kin and others having claims in respect of the estate of the deceased, who died on 3 March 2003, are required by the trustees, Ian Stanley Fraser and Hugh Wetherall Fraser, to send particulars to the trustees care of the undermentioned solicitors by 18 July 2003 after which date the trustees may convey or distribute the assets, having regard only to the claims of which they then have notice.

McKEAN & PARK, lawyers & consultants,
405 Little Bourke Street, Melbourne 3000.

Creditors, next-of-kin and others having claims in respect of the Will of WILLIAM McINTYRE, late of Matron Arthur House, Robinson Street, Horsham, Victoria, pensioner, deceased, who died on 18 January 2003, are requested to send particulars of their claims to the executor, Joseph John Chester McIntyre, care of the undermentioned legal practitioner by 25 July 2003 after which date he may convey or distribute the assets having regard only to the claims of which he then has notice.

POWER & BENNETT, lawyers,
12 Pynsent Street, Horsham, Vic. 3400.

WILLIAM HUNTER CURTAIN, late of Hurlingham Nursing Home, 68 Union Street, Brighton, Victoria, retired, deceased. Creditors, next-of-kin and others having claims in respect of the estate of the abovenamed deceased, who died on 15 August 2002, are required to send particulars of their claim to the executors, Marie Therese Curtain and James Curtain care of the undermentioned solicitors by 15 July 2003 after

which date the said executors will distribute the assets having regard only to the claims of which they then have notice.

T. J. MULVANY & CO., solicitors,
2nd Floor, 51 Queen Street, Melbourne 3000.

NORA WINIFRED SIMMONS, deceased.

Creditors, next-of-kin and others having claims against the estate of NORA WINIFRED SIMMONS, late of Crest Haven Special Accommodation House, 26 Lightwood Road, Springvale, Victoria, retired, deceased, who died on 5 October 2002, are required to send particulars of their claims to the executor care of the undermentioned solicitor by 15 July 2003 after which date the executor will proceed to distribute the assets having regard only to the claims of which he shall then have had notice.

VERNA A. COOK, solicitor,
5/8 St. Andrews Street, Brighton 3186.

In the Supreme Court of the State of Victoria
SALE BY THE SHERIFF

On Wednesday 11 June 2003 at 2.30 p.m. at the Sheriff's Office, 8-20 King Street, Oakleigh. (Unless process be stayed or satisfied).

All the estate and interest (if any) of Andrew Cox of 110 Melbourne Road, Williamstown, as shown on Certificate of Title as Andrew Damian Cox, joint proprietor with Lynne Anne Horner-Cox of an estate in fee simple in the land described on Certificate of Title Volume 2870, Folio 841 upon which is erected a house known as 110 Melbourne Road, Williamstown.

Registered Mortgage No. AB881599H and Caveat No. AB883363D affect the said estate and interest.

Terms – Cash/Eftpos
(Debit Card only. No Credit Cards).
SW-02-011280-9

Dated 8 May 2003

V. PARKIN
Sheriff's Office

In the Supreme Court of the State of Victoria
SALE BY THE SHERIFF

On Wednesday 11 June 2003 at 2.30 p.m. at the Sheriff's Office, 8-20 King Street, Oakleigh. (Unless process be stayed or satisfied).

All the estate and interest (if any) of Richard Bedford of 14 MacGregor Street, Parkdale, as shown on Certificate of Title as Richard Norman Bedford, joint proprietor with Daniela Bedford of an estate in fee simple in the land described on Certificate of Title Volume 8096, Folio 954 upon which is erected a dwelling known as 14 MacGregor Street, Parkdale.

Registered Mortgage No. N219305V and Caveat No. N615780W affect the said estate and interest.

Terms – Cash/Eftpos
(Debit Card only. No Credit Cards).
SW-02-007457-3
Dated 8 May 2003

V. PARKIN
Sheriff's Office

In the Supreme Court of the State of Victoria
SALE BY THE SHERIFF

On Wednesday 11 June 2003 at 2.30 p.m. at the Sheriff's Office, 8–20 King Street, Oakleigh.
(Unless process be stayed or satisfied).

All the estate and interest (if any) of Djuro Juri Mijic of Unit 1, 4 Glover Court, Toorak, joint proprietor with Dusan Mijic, Marija Mijic and Lazar Mijic of an estate in fee simple in the land described on Certificate of Title Volume 9641, Folio 698 upon which is erected a unit known as Unit 1, 4 Glover Court, Toorak.

Registered Covenant No. 1791366 affects the said estate and interest.

Terms – Cash/Eftpos
(Debit Card only. No Credit Cards).
SW-02-009836-6
Dated 8 May 2003

V. PARKIN
Sheriff's Office

Unclaimed Moneys Act 1962

Register of Unclaimed Moneys held by the —

<i>Name of Owner on Books and Last Known Address</i>	<i>Total Amount Due to Owner</i>	<i>Description Of Unclaimed Money</i>	<i>Date when Amount first became Payable</i>
CITY OF PORT PHILLIP			
	\$		
D. Chamberlain & A. McGindle, 8 Cressy Street, Malvern	184.28	Cheque	31/08/00
Coules Pty Ltd, 1 Mathilde Road, Surrey Hills	108.50	"	16/11/00
Adrian Penberthy, 15 Nott Street, Port Melbourne	137.05	"	11/01/01
Louise Van Herwerden, 23 Brunning St, East St Kilda	105.68	"	01/02/01
Melbourne Triathlen Street, 157 Bress Road, East Keilor	100.00	"	15/02/01
Ezycrete, 6 Steele Street, St Kilda	200.00	"	15/03/01
Damien Linsley, 39 Ormond Esplande, Elwood	181.00	"	"
Em Pearce, 49 Iffla Street, South Melbourne	420.00	"	"

Julie Ann Stringer, 5/106 Nimmo Street, Middle Park	266.00	''	19/04/01
Victorian Marching Band Assoc, Shop 54, Waverley Gardens Shopping Ctr, Mulgrave	275.00	''	''
Independent Book Sellers, 32 Eveline Street, Mont Albert	275.00	''	10/05/01
Megan Morgan, Unit 2/3 Austin Avenue, Elwood	165.00	''	31/05/01
Simone Marrocco, 39 Westall Rd, Clayton South	309.50	''	''
Mat Martino, 421 Clarendon Street, South Melbourne	200.00	''	29/06/01
City Central Building, 25/1 Commercial Road, Highett	145.00	''	12/07/01
Megan Senior, 12 Holton Street, North Carlton	275.00	''	11/10/01
City Of Stonnington, PO Box 21, Prahran	175.00	''	01/11/01
Matt Cody, 67 Charles St, Northcote	200.00	''	20/12/01
Tania Darvell, 12/24 Park Street, St Kilda	154.00	''	04/01/02
Cleopatra, 159 Fitzroy Street, St Kilda	243.50	''	17/01/02
Lentil as Anything, 44 Blessington St, St Kilda	150.00	''	24/01/02
Maccabi Australia, PO Box 86, Toorak	275.00	''	31/01/02
Gillian Upton, 45 Nightingale Street, Balaclava	100.00	''	14/02/02
First Motor Brokers, 23 Buckhurst Street, South Melbourne	199.99	''	07/03/02

03149

CONTACT: STEVEN CONWAY, PHONE: (03) 9209 6570.

Unclaimed Moneys Act 1962

Register of Unclaimed Moneys held by the —

<i>Name of Owner on Books and Last Known Address</i>	<i>Total Amount Due to Owner</i>	<i>Description Of Unclaimed Money</i>	<i>Date when first became Payable</i>
PACIFICA GROUP LIMITED			
\$			
Anmac Nominees Pty Ltd, "Gaetjens Group Settle A/c", C/- Kelly & Co, 91 King William Street, Adelaide, SA	105.00	Cheque	06/04/01
Mr Alistair Ian Campbell, 77 Stanhope Street, Malvern	105.00	''	''
Mr Graeme Clive Roberts, PO Box 126, Barraba, NSW	105.00	''	''
Mrs Yvonne Marion Worthington, 26 Lyndhurst St, Richmond	105.00	''	''
Mr Andrew King & Mrs Meredith King, PO Box 230, Knoxfield	105.15	''	05/10/01
Mr Stephen James Garnsworthy, 13 Honeysuckle Avenue, Mulgrave	105.53	''	06/04/01
Beauvoir Pty Limited, C/- Mrs A. S. Wall, RSD 1483, Kinchega, Casterton	106.76	''	05/10/01
Mrs Lynne Vivian Johnson, 11 Birok Ave, Engadine, NSW	109.00	''	''
Mrs Betty June Young, Unit 2, 5 Trentham St, Sandringham	110.33	''	''
Mrs Marie Elizabeth Ball, 27 Research Avenue, Research	110.50	''	''
Miss Renee Nutbean, PO Box 529, Kyneton	110.50	''	''
Ms Helen Votrubic, 20 McIntosh Street, Gordon, NSW	115.50	''	06/04/01
Mr Kuo Chin Hsu, Unit 3, 341 Anzac Parade, Kingsford, NSW	116.50	''	05/10/01

Mr Dusko Pejnovic & Mrs Alison Laura Pejnovic, 38 Nirvana Avenue, Malvern East	116.50	''	''
Mr Neville Creighton Farrall, 70 Sheffield St, Malvern, SA	119.94	''	''
Mr Michael John Anderson, "Life After Work Super A/c", 14 Adelaide Street, Balgowlah Heights, NSW	121.35	''	06/04/01
Johlon Pty Limited, Retireinvest, PO Box 645, Newcastle, NSW	121.89	''	05/10/01
Mr David Alexander Ross Vroland, 402 Daisei Building, 4-33-11 Ikejiri Setagaya-Ku, Tokyo, Japan	122.38	''	''
Mr Ludwik Wylaz, 126 Ballarat Road, North Geelong	123.08	''	''
Mr Keith Reynolds, "Select Superannuation A/c", PO Box 663, Kent Town, SA	127.50	''	''
Verzogerung Pty Ltd, "Evans Partners S/F A/c", 47 O'Grady Street, Albert Park	127.50	''	''
Leperston Pty Ltd, 16 Friend Street, Murtoa	128.44	''	''
Miss Renee Nutbean, PO Box 529, Kyneton	136.50	''	06/04/01
Mr Sava Jankovic, 18 Conran Avenue, Endeavour Hills	141.75	''	''
Murbe Pty Ltd, 17 Heyington Place, Toorak	155.00	''	05/10/01
Mr Keith Reynolds, "Select Superannuation A/c" PO Box 663, Kent Town, SA	157.50	''	06/04/01
Verzogerung Pty Ltd, "Evans Partners S/F A/c", 47 O'Grady Street, Albert Park	157.50	''	''
Mr Ian Burns & Mrs Catherine Burns, "Burns Super Fund A/c", 874 Hampton Street, Brighton	158.51	''	05/10/01
Madarra Nominees Pty Ltd, "Superfund A/c", C/- Marshall Restorations, Factory 7/5 Samantha Court, Knoxfield	161.50	''	''
Murbe Pty Ltd, 17 Heyington Place, Toorak	165.00	''	06/04/01
Mrs Heather Jean Greenaway, 446 RT 81, Killingworth, Connecticut, USA	166.00	''	05/10/01
Diana Patricia Nicholson, 5 Wilson Street, North Carlton	167.79	''	''
Mr Ian Burns & Mrs Catherine Burns, "Burns Super Fund A/c", 874 Hampton Street, Brighton	168.57	''	06/04/01
Big Bear Pty Ltd, "Peter Lloyd Dixon Super Fund", 158 Church Street, Brighton	170.00	''	05/10/01
Leisha Bertini Marketing Pty Ltd, "LBM Superannuation Fund A/c", 36 The Righi, Eaglemont	170.00	''	''
Ms Sheila Anita Sawrey, 70 Roseberry Street, Hawthorn	173.40	''	''
Mr Jude Joachim Gonsalvez, 41 Power Street, Dandenong	174.25	''	''
Mrs Johanna Margaretha Finnholm, 12/7 O'Brien Street, Bondi Beach, NSW	182.00	''	06/04/01
Mrs Heather Jean Greenaway, 446 RT 81 Killingworth, Connecticut, USA	196.00	''	''
Madarra Nominees Pty Ltd, "Superfund A/c", C/- Marshall Restorations, Factory 7/5 Samantha Court, Knoxfield	199.50	''	''
Ms Koon Koh, 5 Arbor Street, Alphington	205.50	''	''
Big Bear Pty Ltd, "Peter Lloyd Dixon Super Fund", 158 Church Street, Brighton Vi	210.00	''	''
Kerrjob Pty Ltd, "Super Fund A/c", PO Box 845, Kyabram	210.00	''	''

Miss Heidi Hau Yu Leung & Mrs Lisa Lai-In Leung To, 18 Latham Court, Glen Waverley	210.00	''	''
R J W Parrish Pty Limited, "The Parrish Super Fund A/c", 17 Brentwood Avenue, Figtree, NSW	210.00	''	''
Ms Sheila Anita Sawrey, 70 Roseberry Street, Hawthorn	214.20	''	''
Mr David George Cole, 1 Coobah Court, Maryborough	224.50	''	05/10/01
Mrs Orani Dixon, 4A Leslie Grove, Brighton Beach	246.08	''	''
Mr Joachim Peter Schutt, "Gordon Terrace S/Fund A/c", 94 Carlton Street, Carlton	247.00	''	06/04/01
Mr Ajit Mario Pieris, 24445 Marine View Drive, Des Moines WA 98198, USA	248.00	''	05/10/01
Mr Dimitrios Giannoulas, 14 Temple Court, Noble Park	258.75	''	''
Bialeema Pty Limited, Level 10, 469 Latrobe St, Melbourne	265.44	''	06/04/01
Mr Dimitrios Giannoulas, 14 Temple Court, Noble Park	275.75	''	''
Mr Derek Frank Hodgson, 468 Willits Hill, Birmingham, MI 48009, USA	276.75	''	05/10/01
Mr George Dragutin Kurjan, 115 Oaktree Drive, Hampton Park	284.75	''	''
Switzerland Insurance Workers Compensation (NSW) Ltd, PO Box 1496, North Sydney, NSW	313.99	''	''
Commercial Nominees of Australia Limited, "R. J. Ferris Superfund A/c", Level 1, 140 Sussex Street, Sydney, NSW	323.00	''	''
Ms Amanda Ashton, 414 Warwick Square, London, SW1V 288, United Kingdom	343.50	''	06/04/01
Mr Stephen James Garnsworthy, 13 Honeysuckle Avenue, Mulgrave	370.18	''	05/10/01
Mr Philip Winbanks & Mrs Jenny Winbanks, "P & J Winbanks S/F A/c", C/- Manning Perry, PO Box 257, Richmond	378.50	''	''
Ms Sue Doyle, 3 Wirra Street, Chapel Hill, Qld	387.00	''	''
Ms Sue Doyle, 3 Wirra Street, Chapel Hill, Qld	411.00	''	06/04/01
Mr Samuel James Morgan & Mrs Norma Morgan, PO Box 32, Waverley, NSW	425.00	''	05/10/01
Mr Derek Frank Hodgson, C/- R. S. Joblin, 264 East Boundary Road, Bentleigh East	545.36	''	''
Mr Michael Roebourne Madigan, C/- Salomon Smith Barney, GPO Box 2419, Adelaide, SA	772.00	''	''
Mr John Wayth Nethercote, 18 Brinsley Road, Camberwell	1,312.50	''	06/04/01
Mrs Claire Phyllis Madigan, C/- Phillips Henderson Ward Limited, GPO Box 2419, Adelaide, SA	1,700.00	''	05/10/01
M. W. F. Pty Limited, 6 Cobby Street, Campbell ACT	4,972.50	''	''
M. W. F. Pty Limited, 6 Cobby Street, Campbell, ACT	6,142.50	''	06/04/01

03060

CONTACT: KAI DIEP, PHONE: (03) 9615 9950.

Unclaimed Moneys Act 1962

Register of Unclaimed Moneys held by the —

<i>Name of Owner on Books and Last Known Address</i>	<i>Total Amount Due to Owner</i>	<i>Description Of Unclaimed Money</i>	<i>Date when Amount first became Payable</i>
MINTER ELLISON TRUST ACCOUNT			
	\$		
HSBC Bank	16,812.19	Cheque	05/02/01

03174

CONTACT: LYN RIDLEY, PHONE: (03) 8608 2783.

Unclaimed Moneys Act 1962

Register of Unclaimed Moneys held by the —

<i>Name of Owner on Books and Last Known Address</i>	<i>Total Amount Due to Owner</i>	<i>Description Of Unclaimed Money</i>	<i>Date when Amount first became Payable</i>
GASCOR PTY LIMITED			
	\$		
Tower Life Australia Ltd, 88 Albert Rd, South Melbourne	371.58	Cheque	31/01/01
Advance Wire and Cable P/L, 19 Downard St, Mordialloc	1,061.46	"	"
A F G Café and Restaurant, 367 Lonsdale St, Dandenong	101.17	"	"
Baria Saraya & Mr Amne Alman, 221 Bay Street, Port Melbourne	162.10	"	"
A M I Toyota, 214 Blackshaws Road, Altona North	177.25	"	"
Wendy Battat, 5/1 Milton Street, Carnegie	278.48	"	"
Andrew Bau, 37 Surrey Road, Dandenong	293.59	"	"
Kylie Beseller, 26 Station Street	139.04	"	"
Brislow & Prentice Pty Ltd, 6 Bay St, Port Melbourne	1,129.48	"	"
Williamstown Graphics (Aust), Mr Paul Brown, 127 Douglas Pde, Williamstown	657.50	"	"
Archies Treats, C/- Mr Bruno Forte, 83B Fitzroy Street, St Kilda	161.42	"	"
Shirley E. Byron, 17 Granville St, Glenroy	476.66	"	"
Carmel Carbine Saloon, 249 Glenhuntly Rd, Elsternwick, Central Argentina of Victoria,	145.74	"	"
Mr J. Boandra, 672 Footscray Road, Footscray	135.73	"	"
Orica Australia Pty Ltd, 3 Summit Rd, Noble Park	2,069.99	"	"
Georgina Coutts, 3/125 Alma Road, St Kilda East	107.74	"	"
Eric W. Coulter, 3/34 Alfred Street, Beaumaris	211.84	"	"
Gary Davison, 178 Beaconsfield Pde, Albert Park	113.36	"	"

Ahmad Dib, 10 Day Street, Sunshine	100.41	''	''
J. P. Dickson P/L, 316 Bay Street, Brighton	262.76	''	''
Loxley Dimel, 12/1158 Dandenong Road, Carnegie	446.96	''	''
Trent Brooks, C/- E. J. Doherty, 95 Bell St, Coburg	398.87	''	''
Eastern Press, 54 Renver Road, Clayton	1,054.08	''	''
Abdul Elhawly, T/a Clarinda Fish & Chip, 1196 Centre Road, Oakleigh	437.91	''	''
Elhouli, 22 Elizabeth Street, Coburgh Nth	329.24	''	''
Farley Cutting Systems Aust., 7 Walter Street	656.90	''	''
Footscray Plaza, John Salama, 4 Paisley St, Footscray	173.57	''	''
Forbes Fashions P/L, 17 Kembla St, Cheltenham	473.63	''	''
Sebastion Fucile Johan Hairdressing, 1015 Mt Alexander Road, Essendon	133.37	''	''
Carol Gaffey, 1 Malmo Ct, Keysborough	135.94	''	''
Gardner Group Pty Ltd, 331A Bay St, Port Melbourne	440.71	''	''
Gemini Town P/L-Bilyana Recep, C/- Mr Tom Spasavski, 67 Gamon St, Footscray	761.59	''	''
W. G. Goetz & Sons Limited (Admin Appointed), 136 Hall Street, Newport	532.94	''	''
Keilor Pizza, Mr Dominic Greco, 12A Kennedy St, Keilor	316.91	''	''
Hardeman and Rolls Packaging, 26 Bricker St, Cheltenham	127.83	''	''
Coling Hayes, 8 Fisher Pde, Ascot Vale	152.81	''	''
Hans Heidler, 30 New Street, Hampton	287.20	''	''
Hillside Childcare Centre, 73 John Paul Drive, Hillside	204.52	''	''
Cathie Hunter, 26 Welling Street, St Kilda	241.50	''	''
Peter & Joanne Papatsaras, 95 Acland Street, St Kilda	252.71	''	''
John Joskic, 59 Hawthorn Rd, Caulfield Nth	110.75	''	''
Karen Klafuric, 3/ 40 Hawthorn St, Coburg	117.88	''	''
Jerry Kosenda, 4 Libbett Avenue, Clayton Sth	138.15	''	''
Ladprow Thai Restaurant, 680 Glenhuntly Rd, Caulfield	650.83	''	''
Antonio Laverde, 85 Carbine Way, Keilor Downs	104.11	''	''
Khiem Val Le, 63 Burden Street, Springvale	139.90	''	''
Tsom Seu Leong, 6/47 Railway Pl, Flemington	120.15	''	''
Diners Regala Restaurant Silkron P/L, 25 Fitzroy Street, St Kilda	230.50	''	''
Present MC Pty Ltd, Nhanh Luong, 15/157 Hyde Street, Yarraville	201.06	''	''
Joyce McVeigh, 3/ 25 Olive Gr, Pascoe Vale	138.41	''	''
Ilham Meats, 81 King Street, Broadmeadows	218.79	''	''
Shayne Micchia and Ms Maria T. Orralba, 25 Roberts Road, Niddrie	210.73	''	''
Mikov Ceramics, 4/57 Sharps Rd, Tullamarine	431.35	''	''
Ventana P/L, Ms Jill Mitchell, C/- Ham MK, 398 Bay Road, Cheltenham	611.10	''	''
Judy & Wendys Munchie Bar, Wendy Neal, 6 Aviation Road, Laverton	168.46	''	''
U. & A. Nafiz, 40 Buckingham Drive, Rowville	156.34	''	''
Nuplex Resins (Aust) Pty Ltd, 161 Westall Rd, Clayton Sth	229.91	''	''
New Mekong Food Pty Ltd, 3 Drake Street, Sunshine	1,802.50	''	''
Willian Albert Nimmo, 3/46 Warwick Rd, Pascoe Vale	252.05	''	''
George & Elizabeth O'Brien, 56 Menzies Av, Dandenong	173.42	''	''
Alex Panagopoulos White Village Restaurant, 572 Glenhuntly Road, Elsternwick	913.33	''	''

Parkdale Pizza (Residence), 220A Como Pde, Parkdale	170.00	''	''
Julien Pigeot & Fabian Small, Mr Matthew Kosmider, 5/20 Matipo Street, Doveton	104.00	''	''
R. Pistrin, 14 Bayview Road, Footscray	100.49	''	''
Protector Security, 85 Kent Road, Pascoe Vale	264.87	''	''
Harry Outt, 21 Field Street	124.95	''	''
Taj Tandoori Madhukar Rao, 281 Glenhuntly Rd, Elsternwick	225.98	''	''
Rising Sun Hotel, 189 Geelong Rd, Footscray West	580.57	''	''
Micks Fish Shop, 20LGS Sarhanis, 18 Heytington Cr, Noble Park	144.59	''	''
Dorothy V. Sauvage, 5/26 Alicia Street, Hampton	132.00	''	''
Jeanette Scott, 12 Stevenson Av, Dandenong	124.46	''	''
Sizzle Works, Mr Leon Naftal, Shop 2022A, 425 Burwood Highway, Wantirna Sth	766.31	''	''
Termination Technology, Mr C. Smitheringle, 12/19 Kylie Pl, Cheltenham	192.00	''	''
Doug Stevens, 155 Bay Street, Port Melbourne	112.09	''	''
Willia P. Swain, 2 Ridge Avenue, Moorabbin	141.06	''	''
Sammy Tabone High Tech Furniture, 16 Comley Street, Sunshine	244.17	''	''
Khamla Thetsomphou, 2/7 Guild Avenue, Noble Park	123.58	''	''
Carmel Thomas, 1/11 Church Road, Carrum	218.11	''	''
Margaret Tjepkema, 85 Johnstone St, Broadmeadows	150.97	''	''
Inga Tranis, 2/16 Melton Avenue, Carnegie	240.63	''	''
Kimberley Nursing Home, 42 Mentone Pde	652.32	''	''
Unilever Australia Pty Ltd, 164 Ingles St, Port Melbourne	136.20	''	''
Harry Veling, 1 Gum Ct, Doveton	121.60	''	''
Michael Vranas, 253 Thomas Street, Dandenong	131.39	''	''
Natasha Watkins, 1/14 Canberra Avenue	150.90	''	''
J. and Y. Australian Foods P/L, Mrs Ying Ye, 5/9 Dingley Avenue, Dandenong	155.08	''	''

03055

CONTACT: NINH HOANG, PHONE: (03) 9201 7409.

Unclaimed Moneys Act 1962

Register of Unclaimed Moneys held by the —

<i>Name of Owner on Books and Last Known Address</i>	<i>Total Amount Due to Owner</i>	<i>Description Of Unclaimed Money</i>	<i>Date when Amount first became Payable</i>
RMIT UNIVERSITY			
	\$		
R. Sanchita, 3/15 Corsewall Close, Hawthorn	990.00	Cheque	03/05/01
L. Tan, 5 Johnson Street, Footscray	1,000.00	''	14/08/01
A. Shepherd, 2/15 Wrexham Road, Prahran	134.00	''	28/08/01

K. Thomson, 5/27 Darling Street, South Yarra	151.00	”	30/08/01
A. Ibrahim, 6 Dealing Drive, Oakleigh South	181.00	”	05/10/01
A. Cusack, 33 Tweedside Street, Essendon	163.00	”	”
P. Hills, 99 Greens Road, Wyndham Vale	160.00	”	11/05/01
J. Plunkett, 46/236 River Terrace, Kangaroo Point	160.00	”	”
N. Samadhi, 2/2 Howson Street, West Brunswick	377.30	”	16/01/02
M. Tillekeratne, 2/31 Wordsworth Avenue, Clayton South	1,333.33	”	23/01/02
T. Nguyen, 753 Burnswick Street, Fitzroy North	150.00	”	06/03/02

03178

CONTACT: D. R. RICHARDS, PHONE: (03) 9925 2778.

J. L. REDDISH, PHONE: (03) 9925 2566.

Unclaimed Moneys Act 1962

Register of Unclaimed Moneys held by the —

<i>Name of Owner on Books and Last Known Address</i>	<i>Total Amount Due to Owner</i>	<i>Description Of Unclaimed Money</i>	<i>Date when Amount first became Payable</i>
CBCHS			
	\$		
Gary Seal, 12 Morrisons Avenue, Mount Martha	331.97	Cheque	02/10/01

03020

CONTACT: KATHY REES, PHONE: (03) 8587 0308.

Unclaimed Moneys Act 1962

Register of Unclaimed Moneys held by the —

<i>Name of Owner on Books and Last Known Address</i>	<i>Total Amount Due to Owner</i>	<i>Description Of Unclaimed Money</i>	<i>Date when Amount first became Payable</i>
VICTORIA LEGAL AID			
	\$		
Peter Dunn, PO Box 670, Benalla	500.00	Cheque	01/03/01
Kiernan Bryant Bourke, PO Box 1025, Carlton	100.00	”	10/08/01
McCracken & McCracken, DX 38202, Flagstaff	1,957.88	”	21/12/99
Dr Robert Simon Benson, C/- Nicholson Medical Centre, Nicholson St, Footscray	100.00	”	12/07/00
Rouel's Pty Ltd, PO Box 473, Brunswick	135.00	”	16/08/00
Patrick Robinson & Co, 262 Queen St, Melbourne	668.00	”	28/08/97

Michael A. Richards, PO Box 236, Caulfield Sth	204.00	''	15/01/98
Mulcahy Mendelson, 526 Whitehorse Rd, Mitcham	481.00	''	08/07/98
H. Long, C/- J. Hyland, DX 99, Melbourne	237.00	''	29/10/98
Royal Children's Hospital Finance Dept, Flemington Rd, Parkville	250.00	''	23/12/98
Community Legal & Finance Centre, PO Box 353, Coburg	967.00	''	11/02/99
Australia Post, GPO Box 2137T, Melbourne	187.00	''	26/03/99
Council for Equal Opportunity in Employment, PO Box 18008, Collins Street, East Melbourne	575.00	''	16/04/99
Auscript, GPO Box 1114J, GPO Privates Boxes, Melbourne	112.50	''	19/05/99
Maddens Lawyers, PO Box 320, Warrnambool	200.00	''	15/10/99
David Recht, 650 Bridge Rd	250.00	''	24/05/00
Dun & Bradstreet, PO Box 7405, Melbourne	308.75	''	02/06/00
Box Hill Hospital, PO Box 94, Box Hill	225.00	''	12/07/00
O'Sullivan, Ruffilli, PO Box 1017, Carlton	150.00	''	20/07/00
Secure Parking, PO Box 6184	135.00	''	11/02/98
Supreme Court of Victoria, Cnr Williams & Lonsdale Sts, Melbourne	230.00	''	22/09/98
Alfred Hospital, PO Box 315, Prahran	220.00	''	05/09/00
Phillip Vidler, 14 Campbell St, Castlemaine	2,088.60	''	27/08/97
Damien McLean, 2/9 Collins St, West Preston	247.00	''	15/01/98
Psychometriks, Level 4, 517 St Kilda Rd, Melbourne	450.00	''	11/12/97

03143

CONTACT: OLGA KASSIS, PHONE: (03) 9269 0474.

Unclaimed Moneys Act 1962

Register of Unclaimed Moneys held by the —

<i>Name of Owner on Books and Last Known Address</i>	<i>Total Amount Due to Owner</i>	<i>Description Of Unclaimed Money</i>	<i>Date when Amount first became Payable</i>
KAY & BURTON ESTATE AGENTS			
	\$		
S. Lim & T. Goh	169.30	Cheque	09/01/02
M. Turner	110.00	''	26/10/00
G. Watkinson, 1804/80 Clarendon Street, Sth Melbourne	190.30	''	19/07/01
B. Ng	552.25	''	10/09/99
M. Naik, 10/17 Darling Street, South Yarra	315.85	''	09/10/01
L. Remedios	397.27	''	19/07/01

03180

CONTACT: KIM ELLIOTT, PHONE: (03) 9820 3033.

Unclaimed Moneys Act 1962

Register of Unclaimed Moneys held by the —

<i>Name of Owner on Books and Last Known Address</i>	<i>Total Amount Due to Owner</i>	<i>Description Of Unclaimed Money</i>	<i>Date when Amount first became Payable</i>
MPRE PTY LTD			
	\$		
Heather Jean Ereaut, 94–96 Moorooduc Road, Frankston	500.00	Cheque	17/07/01

03173

CONTACT: SALLI WRATTEN, PHONE: (03) 9781 5211.

Unclaimed Moneys Act 1962

Register of Unclaimed Moneys held by the —

<i>Name of Owner on Books and Last Known Address</i>	<i>Total Amount Due to Owner</i>	<i>Description Of Unclaimed Money</i>	<i>Date when Amount first became Payable</i>
CITY OF WHITTLESEA			
	\$		
R. Camilleri, 57 William Street, Lalor	150.00	Cheque	05/03/01
Lyndham Partners, DX 30252, Werribee	313.50	"	"
D. Bozinovski, 25 Grand Pde, Epping	364.37	"	"
M. Papas, 10 Yvette Court, Epping	150.00	"	"
CSR Gyprock, 2–6 Horn Street, Thomastown	150.00	"	"
Tiltform Constructions, 227 Edward St, East Brunswick	750.00	"	"
Lorraine Jones & Associates, PO Box 961, Eltham	134.99	"	"
Premier Developments Pty Ltd, PO Box 41, Avondale Heights	270.00	"	"
Desa Constructions, C/- Level 5, 552 Lonsdale Street, Melbourne	400.00	"	"
Z. Rexhepi, c/o LDC, 255 Drummond Street, Carlton	345.00	"	"
Northern Cougars Basketball Club, 3 Extons Close, Epping	100.00	"	"
Vevi Banitsa Youth Club, 17 Kay Avenue, Lalor	300.00	"	"
Devonshire Conveyancing, PO Box 602, Sunshine	165.00	"	"
Preston Bottle Depot, Prviate Bag 29, Camberwell	1,000.00	"	"
Keast Construction & Maintenance, 18 Linton Street, Waterford Park	400.00	"	"
Lalor Living & Learning Centre, 1 Cyprus Street, Lalor	100.00	"	"
M. Gentile, 26 Elizabeth Drive, Lalor	135.00	"	28/03/01
A. Line Builders, Main Road, Kinglake West	200.00	"	04/04/01
Bel-Air Design Group, 4 Sydney Cres, Lalor	100.00	"	"

F. Genis, 17 Kay Avenue, Lalor	300.00	''	''
Glenty Properties Pty Ltd, PO Box 14157, Melbourne Mail Centre	300.00	''	''
GTK Lovitt Homes, 5 Lovitt Cl, Diamond Creek	150.00	''	''
Heritage Homes, 24 Graydon Street, Ferntree Gully	300.00	''	''
T. James, 8 The Mears, Epping	200.00	''	''
Keswick Crest, PO Box 135, Kilsyth	250.00	''	''
T. Mizzi, 1 Hopper Crt, Mill Park	100.00	''	''
G. Muleta, 9 Stanton Pl, Mill Park	150.00	''	''
M. O'Connor, 8 Glenlea Crt, Mill Park	100.00	''	''
PVC Building Design, 533 Plenty Road, Preston	100.00	''	''
A. J. Tavolaro, 4 Sydney Crescent, Lalor	150.00	''	''
A. J. Williams, 11 Winfred Ct, South Morang	150.00	''	''
M. Bonadio, 11 Prince Andrew Avenue, Lalor	200.00	''	26/04/01
M. Childs, 5 Opir Street, Broadmeadows	100.00	''	''
Preston Homes Pty Ltd, 60 Janna Rd, Eden Park	200.00	''	''
G. J. White, 20 Yannuga Street, Rye	150.00	''	''
S. P. Bedrac, 28 Prince of Wales Avenue, Mill Park	100.00	''	16/05/01
Deanmill Homes, 4 Tolson Crt, Roxburg Park	150.00	''	''
S. Despotidis, 6 Birch Ctr, Mill Park	100.00	''	''
V. Sofa, 20 Herman Road, Lalor	100.00	''	''
J. Carter, 29 Charteris Dve, East Ivanhoe	200.00	''	23/05/01
Charles Tinney, Lawyer, DX9823, Greensborough	112.06	''	30/05/01
Be Dared Pty Ltd, C/- F. Napoli, 44/81-97 Mitcham Rd, Donvale	492.53	''	27/06/01
DNP Constructions, 10 Blackwood Wlk, South Morang	291.55	''	25/07/01
P. Singh, 10 Romano Avenue, Mill Park	650.00	''	29/08/01
Kidz Design Update, 2 Acmera Crt, Mill Park	400.00	''	19/09/01
Santon Developments, PO Box 1042, Thornbury	400.00	''	09/10/01
Glenty Properties Pty Ltd, PO Box 14157, Melbourne Mail Centre	800.00	''	''
Glenburn Homes Pty Ltd, 17 Lochabar Crt, Ivanhoe	400.00	''	''
A. Bellizia, 43 Casey Drive, Lalor	400.00	''	''
Marcardon Holdings Pty Ltd, PO Box 253, East Bentleigh	400.00	''	''
Quint Essential Design & Constructions, 33 Williams Road, Briar Hill	200.00	''	''
P. Bourinaris, 334 Findon Road, Epping	100.00	''	''
Ferngrove Homes Pty Ltd, 729 High Street, Epping	1,050.00	''	''
Hanukah Pty Ltd, 7 Warburton Crt, Mill Park	650.00	''	''
Weslene Pty Ltd, 25 Sussex Street, Preston	400.00	''	''
H. & H. Builders, 30 Kangaroo Ground Rd, Wattle Glen	100.00	''	''
S. Vacirca, 10 Scarborough Road, Epping	100.00	''	''
M. H. Speekman, 4 Patrick Street, Thomastown	100.00	''	''
R. Mercuri, 78 Memorial Avenue, Epping	100.00	''	''
G. Pywell, 54 Grenda Drive, Mill Park	100.00	''	''
Alkin Pty Ltd, 11 Cromwell Crt, Lalor	100.00	''	''
R. Verna, 46 Queenscliff Road, Thomastown	400.00	''	''
Davies Homes, PO Box 320, Thomastown	400.00	''	''
R. Antolovich, 110 Greythorn Rd, North Balwyn	400.00	''	''
V. Celestino, 313 Church Rd, Templestowe	400.00	''	''
Lilacgrove Pty Ltd, Level 6, 1 Princess Street, Kew	800.00	''	''
Sef Constructions Pty Ltd, 355 Bell Street, Preston	400.00	''	''
Strato Homes Pty Ltd, 30-32 McAdam Sq, Croydon	400.00	''	''

P. & H. Nanacarrow Pty Ltd, 8 Honeysuckle Crt, Mill Park	400.00	''	''
Masefield Lodge Pty Ltd, 4 Halley Crescent, Campbellfield	400.00	''	''
Merrison Pty Ltd, PO Box 14157, Melbourne Mail Centre	400.00	''	''
Glenhaven Homes, 8/15 Stud Road, Bayswater	400.00	''	11/10/01
VMJ Engineering, C/- 20 Erual Avenue, Preston	400.00	''	09/10/01
D. & J. Leonard Builders, 35 Davis Dve, Mt Eliza	500.00	''	11/10/01
Marcardon Holdings Pty Ltd, PO Box 253, Bentleigh	400.00	''	''
Salvas Homes Pty Ltd, PO Box 378, St Albans	400.00	''	''
Chrislin Homes, 1006 Doncaster Rd, East Doncaster	400.00	''	''
C. C. Homes, 119 Maribyrnong Road, Ascot Vale	400.00	''	''
G. Gioftsis, 36 Kanimbla Drive, Lalor	400.00	''	''
A. Tsoumerkias, 5 Burbank Drive, Reservoir	400.00	''	''
M. Gleeson, 26 Highlands Road, Thomastown	150.00	''	''
C. Lee, 61 Valley Pde, Glen Iris	150.00	''	''
A. Patterson, 10 Winchester Avenue, Epping	300.00	''	''
D. Belevski, 1 Bradman Tce, Epping	400.00	''	17/10/01
S. Cordell, PO Box 428, Thomastown	400.00	''	24/10/01
M. Ozturk, C/- 225 High Street, Thomastown	400.00	''	''
N. Pizzica, 16 Idriess Crt, Mill Park	650.00	''	29/10/01
P. Scheyer, 17 Athena Pl, Epping	200.00	''	14/11/01
P. W. Nancarrow, 8 Honeysuckle Crt, Mill Park	400.00	''	''
W. N. Short, 4 Kellerher Street, Lalor	150.00	''	''
F. L. Napoli, 8 Hamilton Crt, Lalor	400.00	''	''
M. Casasanta, 77 Macorna Street, Watsonia	150.00	''	23/01/02
Northern Fiji Islamic, 47 Blossom Park Dve, Mill Park	200.00	''	''

03052

CONTACT: ALICE WELLS, PHONE: (03) 9217 2294.

Unclaimed Moneys Act 1962

Register of Unclaimed Moneys held by the —

<i>Name of Owner on Books and Last Known Address</i>	<i>Total Amount Due to Owner</i>	<i>Description Of Unclaimed Money</i>	<i>Date</i>
			<i>when Amount first became Payable</i>
NICHE MEDIA PTY LTD			
Nicholas Brooke, former Deed Administrator PricewaterhouseCoopers, Level 4, 215 Spring Street, Melbourne, Vic. 3000			
\$			
Australasian Apple Programmers and Developers Ass'n 16 Redbourough Road, Frenchs Forest, NSW	3,411.53	Cheque	27/08/01
Australasian Apple Programmers and Developers Ass'n 16 Redbourough Road, Frenchs Forest, NSW	4,456.95	''	23/11/01
Australasian Apple Programmers and Developers Ass'n 16 Redbourough Road, Frenchs Forest, NSW	4,691.40	''	15/01/02

03137

CONTACT: JANE LESTER, PHONE: (03) 8603 1198.

Unclaimed Moneys Act 1962

Register of Unclaimed Moneys held by the —

<i>Name of Owner on Books and Last Known Address</i>	<i>Total Amount Due to Owner</i>	<i>Description Of Unclaimed Money</i>	<i>Date when Amount first became Payable</i>
LAMB CASSIDY BARRISTERS & SOLICITORS TRUST ACCOUNT			
	\$		
Elvis Mirko Kojcic, 14 Clonard Avenue, Geelong West	1,132.37	Cheque	17/11/97

03176

CONTACT: VAUGHAN LAMB, PHONE: (03) 5221 1744.

PROCLAMATIONS

ACT OF PARLIAMENT

Proclamation

I, John Landy, Governor of Victoria, declare that I have today assented in Her Majesty's name to the following Bills:

No. 8/2003 **Business Licensing Legislation (Amendment) Act 2003**

No. 9/2003 **Control of Weapons and Firearms (Search Powers) Act 2003**

No. 10/2003 **Crimes (Property Damage and Computer Offences) Act 2003**

No. 11/2003 **Health Legislation (Research Involving Human Embryos and Prohibition of Human Cloning) Act 2003**

No. 12/2003 **Pay-roll Tax (Maternity and Adoption Leave Exemption) Act 2003**

No. 13/2003 **Sentencing (Amendment) Act 2003**

No. 14/2003 **Terrorism (Commonwealth Powers) Act 2003**

Given under my hand and the seal of Victoria at Melbourne on the 6th May 2003.

(L.S.) JOHN LANDY
Governor

By His Excellency's Command

STEVE BRACKS
Premier

this Act come into operation on a day or days to be proclaimed.

(3) If a provision referred to in sub-section (2) does not come into operation before 1 January 2004, it comes into operation on that day.

No. 10/2003 This Act comes into operation on the day after the day on which it receives the Royal Assent.

No. 11/2003 This Act comes into operation on a day or days to be proclaimed.

No. 12/2003 This Act comes into operation on the day on which it receives the Royal Assent.

No. 13/2003 (1) Subject to sub-section (3), this Act (except Part 4) comes into operation on a day or days to be proclaimed.

(2) Part 4 is deemed to have come into operation on 17 February 2003.

(3) If a provision of this Act does not come into operation before 1 July 2004, it comes into operation on that day.

No. 14/2003 This Act comes into operation on the day after the day on which it receives the Royal Assent.

No. 8/2003 (1) Subject to sub-section (2), this Act comes into operation on a day or days to be proclaimed.

(2) If a provision of this Act does not come into operation before 1 June 2004 it comes into operation on that day.

No. 9/2003 (1) This part comes into operation on the day after the day on which this Act receives the Royal Assent.

(2) Subject to sub-section (3), the remaining provisions of

Land Act 1958

PROCLAMATION OF ROAD

I, John Landy, Governor of Victoria with the advice of the Executive Council and under section 25(3)(c) of the **Land Act 1958** proclaim as road the following land:

MUNICIPAL DISTRICT OF THE
MOUNT ALEXANDER SHIRE COUNCIL

FARADAY — The land in the Parish of Faraday, being Crown Allotment 2001 shown by hatching on plan hereunder (GP1049) — (06/P120302).

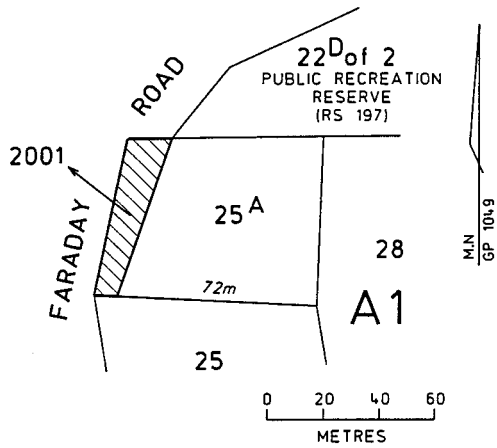

This Proclamation is effective from the date on which it is published in the Government Gazette.

Given under my hand and the seal of Victoria on the 6th May 2003.

(L.S.) JOHN LANDY
Governor
By His Excellency's Command

MARY DELAHUNTY, MP
Minister for Planning

**GOVERNMENT AND OUTER BUDGET SECTOR AGENCIES
NOTICES**

SWAN HILL RURAL CITY COUNCIL

Road Discontinuance

Under Section 206 and Schedule 10, Clause 3 of the **Local Government Act 1989** the Swan Hill Rural City Council at its ordinary meeting held on 8 April 2003 formed the opinion that the road shown hatched on the plan below is not reasonably required as a road for public use and resolved to discontinue the road and transfer the land from the road to the abutting owners.

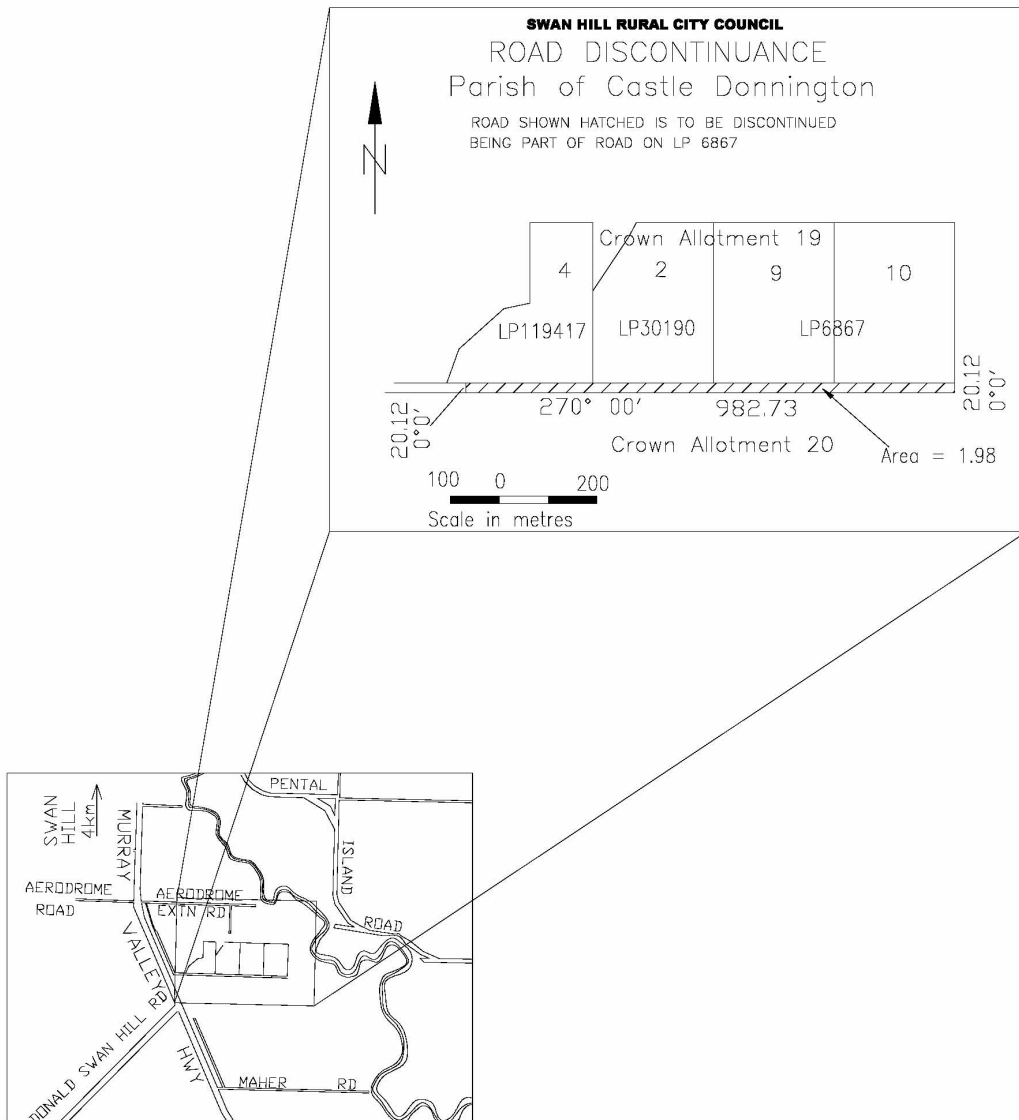

JOHN WEBB
Chief Executive Officer

COLAC OTWAY SHIRE COUNCIL

Notice of Intention to Declare Road Closed Grey River Area

Colac Otway Shire Council gives notice that it intends to close the following Crown Land road reserve under Schedule 10 of the **Local Government Act 1989**.

The road reserve is described as unused Government road in the Parish of Wongarra, situated between Part 2 of LP 91005 and Crown Allotment 30C shown black on plan below.

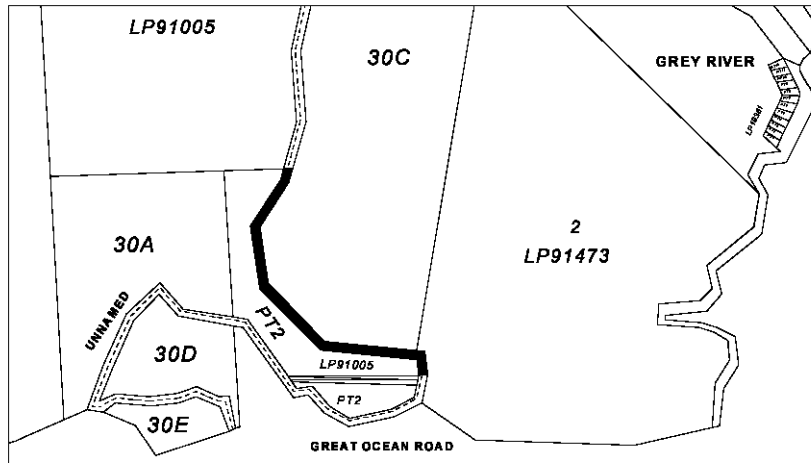

ROB SMALL
Chief Executive Officer

CITY OF WHITEHORSE

Road Discontinuance

Under Section 206 and Schedule 10, Clause 3 of the **Local Government Act 1989** the Whitehorse City Council at its meeting held on 24 September 2002 formed the opinion that the road shown on the plan below is not reasonably required as a road for public use and resolved to discontinue the road, and to sell the land from the road to the abutting owners, subject to any right, power or interest held by Telstra Corp Ltd and Multinet Gas Pty Ltd in the road in connection with any wires, cable or pipes under the control of those authorities in or near the road, pursuant to Section 207C of the Act.

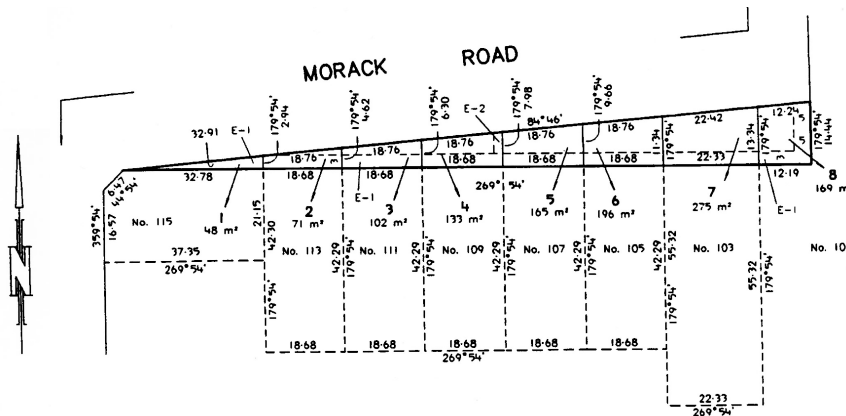

NOELENE DUFF
Chief Executive Officer

Planning and Environment Act 1987
COLAC OTWAY PLANNING SCHEME
 Notice of Preparation of Amendment
 Amendment C16

The Colac Otway Shire Council has prepared Amendment C16 to the Colac Otway Planning Scheme.

The land affected by the Amendment is part Crown Allotment 8 & 9, Section 4, Township of Beac, Parish of Ondit, 25 Coulstone Street, Beac.

The Amendment proposes to correct the present anomalous zoning from Public Park & Recreation Zone (PPRZ) to Township Zone (TZ). The correct zoning reflects the existing and likely future uses of the land.

You may inspect the Amendment, any documents that support the Amendment and the explanatory report about the Amendment at the following locations: at the office of the planning authority, Colac Otway Shire, Rae Street, Colac 3250; at the Department of Sustainability & Environment, Office of Planning, 180 Fyans Street, South Geelong 3219; and at the Department of Sustainability and Environment, Planning Information Centre, Upper Plaza, Nauru House, 80 Collins Street, Melbourne.

This can be done during office hours and is free of charge.

Any person who may be affected by the Amendment may make a submission to the planning authority.

The closing date for submissions is Friday 6 June 2003. A submission must be sent to Mr Gary Dolan, Acting General Manager, Infrastructure & Planning, Colac Otway Shire, PO Box 283, Colac 3250.

ROB SMALL
 Chief Executive Officer

Planning and Environment Act 1987
GLEN EIRA PLANNING SCHEME
 Notice of the Preparation of an Amendment
 to a Planning Scheme
 Amendment C33

Glen Eira City Council has prepared Amendment C33 to the Glen Eira Planning Scheme.

Planning Scheme Amendment

The Amendment proposes to change the Glen Eira Planning Scheme by inserting a provision in the Schedule to Clause 52.02 to vary the restrictive covenant contained in Instrument of Transfer No. 1029936 applying to land at 12 Gnarwyn Road, Carnegie, described as Lot 2 on Plan of Subdivision 32000 on Certificate of Title Volume 09225, Folio 289.

The Covenant currently states, among other things, that the owner of the land will not:

“erect or allow to be erected . . . any building other than one dwelling house with the usual outbuildings and that such dwelling house and outbuildings together with fences shall not be of less value or cost than three hundred pounds and such dwelling shall be at least fifteen feet from the building line and further that he will not remove or cause or allow to be removed on the said Lot any buildings or sheds of any description and further that he will not remove or cause or allow to be removed from the said Lot any sand soil earth stone marl clay or gravel and that he will not make or allow or cause to be made any excavation in the said Lot except for the purposes of building thereon.”

Planning Application

The Covenant is to be varied to allow the development of the land for two dwellings in accordance with the draft planning permit number GE/PP-14832/2002 prepared by the Glen Eira City Council.

The following documents may be inspected during office hours free of charge: the Amendment and the application; documents supporting the Amendment; and the explanatory report about the Amendment at either Glen Eira City Council, Service Centre, Ground Floor, corner of Glen Eira and Hawthorn Roads, Caulfield and Department of Infrastructure, Customer Service Centre, Upper Plaza, Nauru House, 80 Collins Street, Melbourne.

The Amendment can also be viewed on Council's website at www.gleneira.vic.gov.au

Any person who may be affected by the Amendment may make a submission to the planning authority. The closing date for submissions is 10 June 2003.

Submissions about the Amendment must be sent to: Amendment C33, Strategic Town Planning Unit, Glen Eira City Council, PO Box 42, Caulfield South 3162.

JASON CLOSE
 Manager Strategic Planning

Planning and Environment Act 1987
GREATER BENDIGO PLANNING SCHEME
 Notice of Amendment
 Amendment C51

The City of Greater Bendigo has prepared Amendment C51 to the Greater Bendigo Planning Scheme which relates to the area generally bounded by Heinz Street to the north, the Bendigo Regional Park and Pratts Park Road to the east, Lloyd Street, Lansell Street and Charleston Road to the south and the railway line to the west.

The Amendment proposes to:

- amend Clause 21.07 to include the East Bendigo Local Structure Plan as a Reference Document;
- introduce Clause 22.06-2 East Bendigo Industrial Precinct to the Local Planning Policy Framework of the Bendigo Planning Scheme;
- rezone from Rural Living Zone (RLZ) a small parcel of Bendigo Regional Park immediately south of Heinz Street, to Public Conservation and Resource Zone (PCRZ), and the Council owned land immediately north of the Food Manufacturing Precinct to Public Use – Local Government (PUZ6). The strip of land abutting the Council owned land to the south will be rezoned from Rural Living Zone (RLZ) to Public Conservation and Resource Zone (PCRZ);
- rezone land parcels on the southeastern corner of Rohs and Victa Road from Industrial 3 Zone (IN3Z) to Industrial 1 Zone (IN1Z);
- rezone land parcel north of Heywood Road from Industrial 1 to (IN1) to Public Park and Recreation Zone (PPRZ) and the small land parcel abutting Murphy Street (Road Reserve) from Industrial 1 (IN1Z) to Residential (R1Z);
- rezone land parcel located on the western side of Baker Street from Public Use Zone – Other Public Use (PUZ7) to Industrial 1 Zone (IN1Z);
- rezone land parcels (former school) on the western side of Murphy Street and north of Strickland Road from Public Use Zone – Other Public Use (PUZ7) to Industrial 3 Zone (IN3Z);

- introduce a Development Plan Overlay (DPO) to the Aerodrome Related Industries Precinct and incorporate a schedule to the DPO, (DPO 13).

The purpose of the overlay is to:

- clearly state the requirements for a Development Plan;
- outline conditions for any permit which is considered prior to the adoption of the Development Plan;
- identify requirements and conditions for planning permits related to use and development within the precinct prior to the preparation and adoption of a development plan;
- exempt an application from notice and review if it is generally in accordance with an adopted Development Plan;
- delete the Development Plan Overlay (DPO1) from the small parcel of Bendigo Regional Park immediately south of Heinz Street, and from the parcel of Council owned land immediately north of the Food Manufacturing Precinct;
- introduce a Heritage Overlay (HO) to the White Hills Reserve and White Hills Chinese Diggings Site and list these two sites in the existing heritage schedule.

The Amendment can be inspected at any of the following locations: City of Greater Bendigo, EDU Building, corner of Lyttleton Terrace and Mundy Street, Bendigo; City of Greater Bendigo, Planning Department, 'Hopetoun Mill', 15 Hopetoun Street, Bendigo; Department of Sustainability and Environment, Northern Region, 57 Lansell Street, Bendigo and Department of Sustainability and Environment, Customer Service Centre, Nauru House, 80 Collins Street, Melbourne.

Any persons affected by the Amendment may make a submission in writing. Submissions must be received by June 26 2003 and must be addressed to: Chief Executive Officer, City of Greater Bendigo, PO Box 733, Lyttleton Terrace, Bendigo 3552.

ANDREW PAUL
 Chief Executive Officer

Planning and Environment Act 1987
MOONEE VALLEY PLANNING SCHEME
 Notice of Amendment
 Amendment C44

Who is the Planning Authority?

This Amendment has been prepared by Moonee Valley City Council. The Council is the Planning Authority for this Amendment.

What the Amendment does

The Amendment proposes to rezone land and make corrections to Zone Maps Nos. 1 and 6 to reflect current and preferred future land uses.

Specifically, the Amendment proposes to:

- rezone land formerly known as Wirrawong Road and Lots 1 and 2 shown on Title Plan 20882L (Volume 07962 folio 176) and adjoining Nos. 77, 79, 81 and 83 Milleara Road from a Road Zone 1 (RDZ1) to a Residential 1 Zone (R1Z);
- rezone land from a Public Use Zone 2 (PUZ2) to a Residential 1 Zone (R1Z) for the land described as Nos. 50, 52, 56, 58, 60, 62 and 64 Vaynor Street; Nos. 2, 4, 6, 8 and 10 Albert Street and Nos. 49, 51, 53–55, 57, 59, 61 and 63 Teague Street, Niddrie.

The Amendment will modify Zone Maps No. 1 and 6 to reflect the change in zone of the subject areas.

Why the Amendment is required

The Amendment is required to change Zone Maps Nos. 1 and 6 to correctly reflect current and preferred future uses of the land, assist in the efficient administration of the Moonee Valley Planning Scheme and provide for orderly planning and development in the City of Moonee Valley.

Where you may inspect this amendment

The Amendment is available for public inspection, free of charge, during the office hours at the following places: Moonee Valley Council Offices, 9 Kellaway Avenue, Moonee Ponds 3039 and Department of Infrastructure, Upper Plaza Nauru House, 80 Collins Street, Melbourne 3000.

Submissions about the Amendment must be sent to: City of Moonee Valley, PO Box 126, Moonee Ponds 3039, by Friday 13 June 2003

JUNE DUGINA
 Acting Chief Executive

Planning and Environment Act 1987
MOORABOOL PLANNING SCHEME
 Notice of Preparation of an Amendment
 Amendment C3

Council has prepared Amendment C3 to the Moorabool Planning Scheme.

The Amendment affects land throughout the municipality.

The Amendment proposes to:

- correct a number of zoning map errors which occurred during the transition to the “new format planning scheme” in June 2000;
- rezone land owned by Central Highlands Water and CFA to reflect the current use of the land;
- correct mapping errors relating to three heritage places which occurred during the transition to the “new format planning scheme” in June 2000;
- correct a number of spelling and grammatical errors in the planning scheme text;
- make minor corrections to the wording of industrial policy to clarify the intent of the provision;
- clarify provisions in Schedule 1 to the Environmental Significance Overlay relating to the information which must accompany an application, decision guidelines and referral requirements and also to introduce exemptions from permit in the overlay (including exemptions for most works, development ancillary to crop raising and certain residential development);
- clarify provisions in Schedule 2 to the Design and Development Overlay relating to the application of the overlay to all land in the municipality, the information which must accompany an application, exemption from notice and appeal provisions; and
- apply a new Schedule 3 to the Design and Development Overlay to all land within 150 metres of the Western Freeway that was not previously included in a design and development overlay governing freeway environs in order to protect the levels of service, safety and amenity of the Freeway, and to minimise any adverse effects of noise on noise sensitive uses.

You may inspect the Amendment, any documents that support the Amendment and the explanatory report about the Amendment at the following locations: at the Ballan Office of Moorabool Shire Council, 15 Stead Street, Ballan; at the Bacchus Marsh Office of Moorabool Shire Council, 197 Main Street, Bacchus Marsh; at the Department of Sustainability and Environment, Western Region, 88 Learmonth Road, Ballarat and at the Department of Sustainability and Environment, Planning Information Centre, Upper Plaza, Nauru House, 80 Collins Street, Melbourne.

This can be done during office hours and is free of charge.

Any person who may be affected by the Amendment may make a submission to the planning authority.

The closing date for submissions is Monday 9 June 2003.

A submission must be sent to the Moorabool Shire Council, PO Box 18, Ballan 3342.

ROBERT DOBRZYNSKI
Chief Executive Officer

Planning and Environment Act 1987

TOWONG PLANNING SCHEME

Notice of Preparation of an Amendment
to a Planning Scheme

(Extended Public Exhibition Period)

Amendment C5

Towong Shire Council has prepared Amendment C5 to the Towong Planning Scheme. The Amendment affects certain land in the following townships or areas: Beetoomba, Berringama, Bethanga, Cudgewa, Eskdale, Granya, Mitta Mitta, Nariel, Old Tallangatta, Tallangatta Valley, Thowgla Upper, Tintaldra, Walwa, and Towong (14 townships or areas).

The Amendment proposes to make the following changes to the Towong Planning Scheme:

- apply the Restructure Overlay to land identified in the 14 townships or areas.;
- introduces restructure plans and development guidelines into the Restructure Overlay schedule for the 14 townships or areas;

- remove any existing Restructure Overlay from those lands not identified in the restructure plans;
- apply the Road Closure Overlay over roads identified in the restructure plans;
- amend the “settlement” section of the Municipal Strategic Statement to provide township overviews and a list of issues and objectives for each town affected by the restructure plans;
- correct a Planning Scheme mapping error by deleting two Rural Floodway Overlay maps to the northwest of Eskdale.

The Amendment, explanatory report and accompanying documentation can be inspected, free of charge, during office hours at Towong Shire Council, Shire Offices, 32 Towong Street, Tallangatta, and Shire Offices, 76 Hanson Street, Corryong; Department of Sustainability and Environment, North Eastern Region, 50–52 Clarke Street, Benalla; and Planning Information Centre, Upper Plaza, Nauru House, 80 Collins Street, Melbourne.

Submissions in writing about the Amendment must be sent to Mr James Laycock, Shire Planner, Towong Shire Council, PO Box 55, Tallangatta 3700, by 2 June 2002. (The previous closing date was 14 April 2003.)

RAY PARK
Chief Executive

Planning and Environment Act 1987

WHITEHORSE PLANNING SCHEME

Notice of the Preparation of an Amendment
to a Planning Scheme

Amendment C46

The land affected by the Amendment is the following properties:

- 130–134 Central Road, Blackburn;
- 16 and 1–9 Florence Street, Blackburn;
- 2–26 and 1–43 Gerald Street, Blackburn;
- 111–125 Lake Road, Blackburn;
- 18–44 and 15–41 Sheehans Road, Blackburn;
- 17 Brenda Street, Nunawading;
- 148–204 and 175–185 Central Road, Nunawading;

- 11B–19 Florence Street, Nunawading;
 - 2–4 Joyce Street, Nunawading;
 - 2 Lewis Court, Nunawading;
 - 2–6 and 1–11 Lilian Street, Nunawading;
 - 2–14 and 1–11 Milton Street, Nunawading;
 - 2–18 and 1–21 Patterson Street, Nunawading;
 - 38–44 and 33–63 Blackburn Road, Blackburn;
 - 8–32 Central Road, Blackburn;
 - 2–8 and 1A–3 Clarke Street, Blackburn;
 - 20–32 and 17–29 Gardenia Street, Blackburn;
 - 2–22 and 1A–19 Gordon Crescent, Blackburn;
 - 15–27 Main Street, Blackburn;
 - 39 The Avenue, Blackburn;
 - 37–43 Wellington Street, Blackburn;
 - 2–38 and 1–33 Wolseley Crescent, Blackburn;
 - 1A–9 Alan Street, Blackburn South;
 - 2–18 and 1–17 Boyd Street, Blackburn South;
 - 176–196 Canterbury Road, Blackburn South;
 - 2–16 and 3–15 Eckersley Court, Blackburn South;
 - 44–50 and 51–57 Gissing Street, Blackburn South;
 - 2–4 and 1–5 Grenville Court, Blackburn South;
 - 4 and 1–7 Margaret Street, Blackburn South;
 - 2–8 and 1–9 Pursell Avenue, Blackburn South;
 - 2–28 and 1A–19 Rosslyn Street, Blackburn South;
 - 1–29 Forest Road, Forest Hill.
- The Amendment proposes to:
- include the following properties in a Significant Landscape Overlay:
 - 130–134 Central Road, Blackburn;
 - 16 and 1–9 Florence Street, Blackburn;
 - 2–26 and 1–43 Gerald Street, Blackburn;
 - 111–125 Lake Road, Blackburn;
 - 18–44 and 15–41 Sheehans Road, Blackburn;
 - 17 Brenda Street, Nunawading;
 - 148–204 and 175–185 Central Road, Nunawading;
 - 11B–19 Florence Street, Nunawading;
 - 2–4 Joyce Street, Nunawading;
 - 2 Lewis Court, Nunawading;
 - 2–6 and 1–11 Lilian Street, Nunawading;
 - 2–14 and 1–11 Milton Street, Nunawading;
 - 2–18 and 1–21 Patterson Street, Nunawading;
 - 1A–9 Alan Street, Blackburn South;
 - 2–18 and 1–17 Boyd Street, Blackburn South;
 - 176–196 Canterbury Road, Blackburn South;
 - 2–16 and 3–15 Eckersley Court, Blackburn South;
 - 44–50 and 51–57 Gissing Street, Blackburn South;
 - 2–4 and 1–5 Grenville Court, Blackburn South;
 - 4 and 1–7 Margaret Street, Blackburn South;
 - 2–8 and 1–9 Pursell Avenue, Blackburn South;
 - 2–28 and 1A–19 Rosslyn Street, Blackburn South;
 - 1–29 Forest Road, Forest Hill;
- include the following properties in a Neighbourhood Character Overlay:
- 38–44 and 33–63 Blackburn Road, Blackburn;
 - 8–32 Central Road, Blackburn;
 - 2–8 and 1A–3 Clarke Street, Blackburn;
 - 20–32 and 17–29 Gardenia Street, Blackburn;
 - 2–22 and 1A–19 Gordon Crescent, Blackburn;
 - 15–27 Main Street, Blackburn;
 - 39 The Avenue, Blackburn;
 - 37–43 Wellington Street, Blackburn;
 - 2–38 and 1–33 Wolseley Crescent, Blackburn;
- insert a new Clause 43.05 (Neighbourhood Character Overlay) and Schedule 1 to this Clause in the Whitehorse Planning Scheme;
- vary the Municipal Strategic Statement and Local Planning Policy Framework to recognise the introduction of a Neighbourhood Character Overlay and the extension of the Significant Landscape Overlay in the Blackburn Area;

- update the list of maps in the Whitehorse Planning Scheme.

You may inspect the Amendment, and any documents that support the Amendment, and the explanatory report about the Amendment at the office of the planning authority, Whitehorse City Council and at the Department of Sustainability and Environment at the following addresses: the City of Whitehorse, Statutory Planning Office Service Centre, 379 Whitehorse Road, Nunawading and Department of Sustainability and Environment, Customer Service Centre, Level 3 Plaza, Nauru House, 80 Collins Street, Melbourne and all libraries and the Service Centres at Box Hill and Forest Hill and on the Internet at www.whitehorse.vic.gov.au/what-docs.asp

This can be done during office hours and is free of charge.

Any person who may be affected by the amendment may make a submission to the planning authority.

Any submission about the Amendment must be made in writing, giving the submitter's name, address and, if practicable, a phone number for contact during office hours. Set out the views on the Amendment, that the submitter wishes to put before Council and indicate what changes (if any) the submitter wishes to be made to the amendment. State whether the person/s making the submission wishes to be heard in support of their submission.

The closing date for submission is 10 June 2003. A submission must be sent to: Mr Gerard Gilfedder, Co-ordinator Planning Projects, City of Whitehorse, Locked Bag 2, Nunawading Delivery Centre, Vic. 3110

Privacy Statement

Any personal information you may include in any submission to Council on the Amendment is collected for planning purposes in accordance with the **Planning and Environment Act 1987** (the Act). The public may view the submission whilst the Amendment is being considered. In accordance with the "Improving Access to Planning Documents" Practice Note dated December 1999, a copy of your submission may be made upon request. If you fail to provide this information your comments may not be considered. You may access this information by contacting Council on 9262 6315.

Dated 8 May 2003

Mr STEPHEN P. WRIGHT
General Manager, City Development

Planning and Environment Act 1987

WODONGA PLANNING SCHEME

Notice of Amendment

Amendment C21

The Wodonga Rural City Council has prepared Amendment C21 to the Wodonga Planning Scheme.

The Amendment proposes map and ordinance changes to the Wodonga Planning Scheme, rezoning 12 hectares of land located 500 metres north of the interchange of the Murray Valley Highway and Hume Freeway from a Rural to a Business 4 Zone. The Amendment affects land described as Part of Allotment 1, Section 31, Parish of Barnawartha North, Murray Valley Highway, Barnawartha North. The Amendment facilitates the provision of a service centre site for the National Distribution Hub, providing opportunities for commercial sites to be developed to serve the daily convenience and service requirements of the Distribution Hub. To ensure development on the land achieves appropriate standards a Design and Development Overlay has been provided over the land, in addition to a Local Policy that will guide the way in which the Council will exercise its discretion in regard to applications to use and develop the land;

The Amendment can be inspected at the City of Wodonga Offices, Hovell Street, Wodonga; Regional Office, Department of Sustainability & Environment, 50-52 Clarke Street, Benalla; Department of Sustainability & Environment, Planning Information Centre, Upper Plaza, Nauru House, 80 Collins Street, Melbourne.

Submissions in writing in respect of the Amendment must be sent to the City of Wodonga, PO Box 923, Wodonga, Vic. 3689 by Monday 16 June 2003.

Council's order number 51965 refers to this advertisement.

DARREN RUDD
Manager Strategic Planning

Creditors, next-of-kin and others having claims against the estate of any of the undermentioned deceased persons are required to send particulars of their claims to State Trustees Limited, ABN 68 064 593 148, 168 Exhibition Street, Melbourne, Victoria 3000, the personal

representative, on or before 10 July 2003 after which date State Trustees Limited may convey or distribute the assets having regard only to the claims of which State Trustees Limited then has notice.

ARAK, Juri Endel, late of Unit 2, 9 Middlesex Road, Surrey Hills, and who died on 13 January 2003.

BRUNT, Lorna Joy, late of Unit 1, Pinetree Retirement Village, 330 Springvale Road, Donvale, retired, and who died on 21 February 2003.

COTRONIS, Eleni, also known as Helen Cotronis, late of 21 Cockaigne Street, Doncaster, Victoria, secretary, and who died on 31 December 2002.

DAVEY, Sarah Jane, late of Glen Waverley Private Nursing Home, 982 High Street, Glen Waverley, widow, and who died on 2 February 2003.

HOE, Joan Christine, formerly of 2/105 Croydon Road, Surrey Hills, but late of Unit 1, 22 Lorne Street, Balwyn, Victoria 3103, retired, and who died on 2 February 2003.

KALEJS, Albert, late of Healesville & District Nursing Home, 494 Don Road, Healesville, Victoria, pensioner, and who died on 24 January 2003.

KEMP, John Alexander, late of Unit 12, 30 Cummings Street, Brunswick West, pensioner, and who died on 6 March 2003.

LANCASTER, Reginald Walter, late of Carrum Nursing Home, 440 Station Street, Carrum, Victoria 3197, retired, and who died on 3 March 2003.

Dated at Melbourne, 2 May 2003

Laurie Taylor,
Estate Manager
State Trustees Limited

STATE TRUSTEES LIMITED
ACN 064 593 148

Section 79

Notice is hereby given that State Trustees Limited, ACN 064 593 148 intends administering the estates of:-

MICHAEL ARTHUR ANDERSON, late of 27 Walker Street, Moonee Ponds, Victoria, nurse, deceased intestate, who died on 5 October 2002.

LEONIE SUE BARNES, late of Kew Residential Cottages, Princess Street, Kew, Victoria, retired, deceased intestate, who died on 11 February 2003.

KATHLEEN SARAH GOUGH, late of 166 Melville Road, Pascoe Vale, Victoria, pensioner, deceased, who died on 25 March 2003, leaving a Will dated 16 July 2002.

MARIE MAGDALENE HILT, late of Kingston Gardens Aged Care, 201 Clarke Road, Springvale South, Victoria, pensioner, deceased, who died on 2 January 2003, leaving a Will dated 7 August 1998.

ERNEST JAMES HOOPER, late of North West Health Centre, Warracknabeal Campus, Dimboola Road, Warracknabeal, Victoria, pensioner, deceased intestate, who died on 23 March 2003.

JOHN HORACE WALLACE POTTEN, late of Glenroy Nursing Home, 85-87 Chapman Avenue, Glenroy, Victoria, pensioner, deceased, who died on 15 December 2002, leaving a Will dated 30 April 1969.

EILEEN MARY STEPHENS, late of Terry Barker Nursing Home, 12-5 Broadford Crescent, Macleod, Victoria, retired, deceased, who died on 18 April 2003, leaving a Will dated 14 January 1982.

Creditors, next-of-kin and others having claims against the abovementioned estates are required pursuant to Section 33 of the **Trustee Act 1958** to send particulars of their claims against the abovementioned estates to State Trustees Limited, 168 Exhibition Street, Melbourne, Victoria, on or before 15 July 2003 after which date State Trustees Limited, ACN 064 593 148, may convey or distribute the assets of the abovementioned estates having regard only to the claims of which it then has notice.

Creditors, next-of-kin and others having claims against the estate of any of the undermentioned deceased persons are required to send particulars of their claims to State Trustees Limited, ABN 68 064 593 148, 168 Exhibition Street, Melbourne, Victoria 3000, the personal representative, on or before 15 July 2003 after which date State Trustees Limited may convey or distribute the assets having regard only to the claims of which State Trustees Limited then has notice.

DUNKLEY, Graham George, late of 66 Queen Street, Altona, pensioner, and who died on 23 March 2003.

LAMOUR, Donald Douglas, also known as Donald Larmour, late of 2 Grano Street, Ararat, retired, and who died on 7 December 2002.

LINCOLN, Eric Rupert, late of Lonsdale House Nursing Home, 88 Cunningham Street, Northcote, Victoria 3070, retired and who died on 16 March 2003.

MINTON, Winifred Isabel, late of 86 Duke Street, Sunshine, Victoria 3020, and who died on 19 January 2003.

SWIFT, Roy Victor, late of Rupanyup Nursing Home, 89 Cromie Street, Rupanyup, Victoria 3388, pensioner, and who died on 16 February 2003.

TOROK, Ilona, late of 16 Keats Avenue, Kingsbury, Victoria 3083, pensioner, and who died on 6 March 2003.

Dated at Melbourne, 6 May 2003

LAURIE TAYLOR,
Estate Manager
State Trustees Limited

EXEMPTION

Application No. A88 of 2003

The Victorian Civil and Administrative Tribunal has considered an application, pursuant to Section 83 of the **Equal Opportunity Act 1995** by Victorian Aboriginal Community Controlled Health Organization Inc (VACCHO). The application for exemption is to enable the applicant to advertise for and employ an Australian Indigenous person in the position of Education Officer in Indigenous Spiritual, Emotional and Social Well-being studies.

Upon reading the material submitted in support of the application the Tribunal is satisfied that it is appropriate to grant an exemption from Sections 13, 100 and 195 of the Act to enable the applicant to advertise for and employ an Australian Indigenous person in the position of Education Officer in Indigenous Spiritual, Emotional and Social Well-being studies.

In granting this exemption the Tribunal noted

- VACCHO represents 27 Aboriginal Community Controlled Health member organizations throughout Victoria;
- VACCHO is recognized by State and Commonwealth governments as the peak body coordinating Aboriginal health organizations and community views in Victoria;
- VACCHO is a Registered Training Organization and is funded to deliver accredited courses within its Scope of Registration;
- The Education Officer will be responsible for leading community based consultations, a course review and accredited training delivery for Victorian based Aboriginal and Torres Strait Islander people in the culturally sensitive area of Indigenous spiritual, emotional and social well-being including trauma and grief;
- VACCHO is committed to addressing the cultural safety issues for participants including culturally appropriate forms of communication. This requires that the position be designated Aboriginal and Torres Strait Islander.

The Tribunal hereby grants an exemption to the applicant from the operation of Sections 13, 100 and 195 of the **Equal Opportunity Act 1995** to enable the applicant to advertise for and employ an Australian Indigenous person to the position of Education Officer in Indigenous Spiritual, Emotional and Social Well-being studies.

This exemption is to remain in force from the day on which notice of the exemption is published in the Government Gazette until 8 May 2006.

Dated 28 April 2003.

Mrs. M. URQUHART
Deputy President

EXEMPTION

Application No. A105 of 2003

The Victorian Civil and Administrative Tribunal has considered an application, pursuant to Section 83 of the **Equal Opportunity Act 1995** by Victorian Aboriginal Community Controlled Health Organization Inc (VACCHO) for exemption from Sections 37, 42, 100 and 195 of the Act. The application for exemption is to enable the applicant to enroll Aboriginal and

Torres Strait Islander (ATSI) students only in Health courses in its Certificate iii, Certificate iv, Diploma and Advanced Diploma; the Diploma in Indigenous Spiritual, Emotional and Social Well-being and Certificate iv, Indigenous Women and Babies and to advertise and promote those courses accordingly.

Upon reading the material submitted in support of the application the Tribunal is satisfied that it is appropriate to grant an exemption from Sections 37, 42, 100 and 195 of the Act to enable the applicant to enroll Aboriginal and Torres Strait Islander (ATSI) students only in Health courses in its Certificate iii, Certificate iv, Diploma and Advanced Diploma; the Diploma in Indigenous Spiritual, Emotional and Social Well-being and Certificate iv, Indigenous Women and Babies and to advertise and promote those courses accordingly.

In granting this exemption the Tribunal noted

- VACCHO represents 27 Aboriginal Community Controlled Health member organizations throughout Victoria;
- VACCHO is recognized by State and Commonwealth governments as a peak body coordinating Aboriginal health education through its organizations;
- VACCHO is a Registered Training Organization and is funded to deliver accredited courses within its Scope of Registration;
- VACCHO is committed to addressing cultural issues for participants.

The Tribunal hereby grants an exemption from Sections 37, 42, 100 and 195 of the Act to enable the applicant to enroll Aboriginal and Torres Strait Islander (ATSI) students only in Health courses in its Certificate iii, Certificate iv, Diploma and Advanced Diploma; the Diploma in Indigenous Spiritual, Emotional and Social Well-being and Certificate iv, Indigenous Women and Babies and to advertise and promote those courses accordingly.

This exemption is to remain in force from the day on which notice of the exemption is published in the Government Gazette until 8 May 2006.

Dated 28 April 2003.

Mrs. M. URQUHART
Deputy President

EXEMPTION

Application No. A109/2003

The Victorian Civil and Administrative Tribunal, has considered an application pursuant to Section 83 of the **Equal Opportunity Act 1995** by Australian Institute of Public Safety for exemption from Sections 37, 42, 100 and 195 of that Act. The application for exemption is to enable the applicant to conduct pre-licensing or accreditation security training courses for women only, to advertise those courses, and to advertise encouraging women to enrol in security training courses in relation to the guarding and security industry.

Upon reading the material submitted in support of the application and upon hearing submissions from Mr T. Zalewski and for the Reasons for Decision given by the Tribunal on 1 May 2003, the Tribunal is satisfied that it is appropriate to grant an exemption from Sections 37, 42, 100 and 195 of the Act to enable the applicant to conduct pre-licensing or accreditation security training courses for women only, to advertise those courses, and to advertise encouraging women to enrol in security training courses in relation to the guarding and security industry.

The Tribunal hereby grants an exemption to the applicant from the operation of Sections 37, 42, 100 and 195 of the **Equal Opportunity Act 1995** to enable the applicant to conduct pre-licensing or accreditation security training courses for women only, to advertise those courses, and to advertise encouraging women to enrol in security training courses in relation to the guarding and security industry.

This exemption is to remain in force from the day on which notice of the exemption is published in the Government Gazette until 7 May 2006.

Dated 1 May 2003

Ms C. McKENZIE
Deputy President

EXEMPTION

Application No. A110 of 2003

The Victorian Civil and Administrative Tribunal has considered an application, pursuant to Section 83 of the **Equal Opportunity Act 1995** by Inner South Community Health Service

Inc. The application for exemption is to enable the applicant to engage in the specified conduct.

In this exemption "specified conduct" means to advertise for and employ people to work in the following positions –

- (a) a male or transgender person to provide health education and support and welfare services to male and transgender street sex workers and workers in the male escort and private male sex worker industry;
- (b) a female or transgender person to provide health education and support and welfare services to female and transgender street sex workers and workers in the female escort and private female sex worker industry;
- (c) 2 females to provide health education and support and welfare services to sex workers in brothels, and female sex workers in the escort and private sex worker industry;
- (d) a female to provide health education and support and welfare services to homeless young women, particularly between the ages of 15 and 24.

The Tribunal grants an exemption from the operation of Sections 13, 100, and 195 of the **Equal Opportunity Act 1995**, to enable the applicant to engage in the specified conduct.

This exemption is to remain in force from the day on which notice of the exemption is published in the Government Gazette until 7 May 2006.

Dated 2 May 2003

Ms C. McKENZIE
Deputy President

EXEMPTION

Application No. A111/2003

The Victorian Civil and Administrative Tribunal has considered an application pursuant to Section 83 of the **Equal Opportunity Act 1995** by Cestui Que Vie Pty Ltd trading as Entre Nous for exemption from Sections 42, 100 and 195 of that Act. The application for exemption is to enable the applicant to engage in the specified conduct.

In this exemption "specified conduct" means any of the following:

- (a) to refuse to provide introduction services to any person who is married and not separated from their spouse;
- (b) to obtain information from members or potential members of its introduction service for the purpose of matching them in social or personal relationships in accordance with their expressed preferences including information about attributes within the meaning of that Act;
- (c) to advise potential members of its introduction service that because of their attributes and the attributes preferred by members of that service it will be difficult to find matches for them, where that advice is based on information in the applicant's possession;
- (d) to charge discounted or no fees to members or potential members depending on their age and/or sex;
- (e) to hold social functions for members or potential members from particular age groups only;
- (f) to advertise on behalf of any member of its introduction service for people wishing to be introduced to that member for the purpose of forming a personal or social relationship and to include in those advertisements information about attributes preferred by the member in the person sought in the advertisements;
- (g) to offer, free of charge, one or more introductions to potential members of the introduction service, based on their attributes and the preferred attributes of members of the service;
- (h) to advertise concerning any of the matters in paragraphs (a) to (g).

Upon reading the material submitted in support of the application and upon hearing submissions from Ms Moore and Ms Neville and for the Reasons for Decision given by the Tribunal on 29 April 2003, the Tribunal is satisfied that it is appropriate to grant an exemption from Sections 42, 100 and 195 of the Act to enable the applicant to engage in the specified conduct.

The Tribunal hereby grants an exemption to the applicant from the operation of Sections 42, 100 and 195 of the **Equal Opportunity Act**

1995 to enable the applicant to engage in the specified conduct.

This exemption is subject to the condition that the applicant must give written advice to the Tribunal if it becomes aware that its database contains sufficient numbers in each age category and in each gender within each age category to fit the preferences of all members of the introduction service.

This exemption is to remain in force from the day on which notice of the exemption is published in the Government Gazette until 7 May 2006.

Dated 29 April 2003.

Ms CATE McKENZIE
Deputy President

Department of Treasury and Finance

SALE OF CROWN LAND
BY PUBLIC AUCTION

Date of Auction: Saturday 31 May 2003 at 1.00 p.m.

Reference: 02/01347, 02/01351 and 02/01348.

Crown Description: Crown Allotments 2001, 2006 and 2007, Parish of Trentham.

Address of Property: Victoria Street, Trentham (Allotment 2001); rear of Victoria Street, Trentham (Allotments 2006 and 2007).

Terms of Sale: Deposit 10%, Balance 60 days.

Area: Allotment 2001 contains 4,466 square metres. Allotment 2006 contains 3,786 square metres. Allotment 2007 contains 1.001 hectares.

Officer Co-ordinating Sale: Peter Jackel, Victorian Government Property Group, Department of Treasury and Finance, 5/1 Treasury Place, Melbourne, Vic. 3002.

Selling Agent: Central Highlands Realty, 43-45 High Street, Trentham, Vic. 3458.

JOHN LENDERS MLC
Minister for Finance

Department of Treasury and Finance

SALE OF CROWN LAND
BY PUBLIC AUCTION

Date of Auction: Thursday 29 May 2003 at 1.00 p.m. on site.

Reference: 97/02249.

Address of Property: Railway Place, Fairfield.

Crown Description: Crown Allotment 114E, Parish of Jika Jika, County of Bourke.

Terms of Sale: Deposit 10%, Balance 60/90 days.

Area: 309m².

Officer Co-ordinating Sale: Lara Morton-Cox, Victorian Government Property Group, Department of Treasury and Finance, 5/1 Treasury Place, Melbourne, Vic. 3002.

Selling Agent: Miles Real Estate Professionals, 143 Upper Heidelberg Road, Ivanhoe, Vic. 3079.

JOHN LENDERS MLC
Minister for Finance

Catchment and Land Protection Act 1994

The Glenelg-Hopkins Regional Catchment Strategy has been accredited by the Commonwealth and Victorian Governments against the national criteria agreed by the Natural Resource Management Ministerial Council. The Chair of the Glenelg-Hopkins Catchment Management Authority Board was advised of this in a letter dated 10 April 2003, signed by David Kemp, Minister for the Environment and Heritage; Warren Truss, Minister for Agriculture, Fisheries and Forestry; John Thwaites, Deputy Premier of Victoria and Victorian Minister for Environment, Water and Victorian Communities; and Bob Cameron, Victorian Minister for Agriculture.

Land Acquisition and Compensation Act 1986

FORM 7

S.21

Reg. 16

Notice of Acquisition

Compulsory Acquisition of Interest in Land

The Secretary to the Department of Infrastructure, declares that by this notice it acquires the following interest in the land described as part of Lots 1 & 2 on Title Plan 616849M (formerly known as part of Lots 134 & 135 on Plan of Subdivision 010506) Parish of Ringwood comprising 139.0 square metres and being land described in Certificate of Title Volume 8916, Folio 470, shown as Parcels 10 and 11 on Survey Plan 20387B.

Interest Acquired: That of Pasquale & Dawn Canale and all other interests.

Published with the authority of the Secretary to the Department of Infrastructure.

Dated 8 May 2003

For and on behalf of the Secretary
to the Department of Infrastructure:
GERRY TURNER,
Manager Property Services Department,
Roads Corporation.

Land Acquisition and Compensation Act 1986

FORM 7 S.21
Reg. 16

Notice of Acquisition

Compulsory Acquisition of Interest in Land

The Secretary to the Department of Infrastructure, declares that by this notice it acquires the following interest in the land described as part of Lot 133 on Plan of Subdivision 010506, Parish of Ringwood, comprising 125.0 square metres and being land described in Certificate of Title Volume 5199, Folio 734, shown as Parcel 12 on Survey Plan 20387B.

Interest Acquired: That of Robert Rule Taylor and all other interests.

Published with the authority of the Secretary to the Department of Infrastructure.

Dated 8 May 2003

For and on behalf of the Secretary
to the Department of Infrastructure:
GERRY TURNER,
Manager Property Services Department,
Roads Corporation.

Land Acquisition and Compensation Act 1986

FORM 7 S.21
Reg. 16

Notice of Acquisition

Compulsory Acquisition of Interest in Land

The Secretary to the Department of Infrastructure, declares that by this notice it acquires the following interest in the land described as part of Lot 2 on Title Plan 334246Q and part of Lot 2 on Title Plan 676445Y, Parish of Ringwood, comprising 346.0 square metres

and being part of the land described in Certificate of Title Volume 8178, Folio 648 and Certificate of Title Volume 8882, Folio 448, shown as Parcels 1, 18 and 19 on Survey Plan 20387B.

Interest Acquired: That of Markmont Pty Ltd and all other interests.

Published with the authority of the Secretary to the Department of Infrastructure.

Dated 8 May 2003

For and on behalf of the Secretary
to the Department of Infrastructure:
GERRY TURNER,
Manager Property Services Department,
Roads Corporation.

Land Acquisition and Compensation Act 1986

FORM 7 S.21
Reg. 16

Notice of Acquisition

Compulsory Acquisition of Interest in Land

The Secretary to the Department of Infrastructure, declares that by this notice it acquires the following interest in the land described as part of Land in Plan of Consolidation 150366, Parish of Ringwood, comprising 238.0 square metres and being land described in Certificate of Title Volume 9384, Folio 306, shown as Parcels 2 and 20 on Survey Plan 20387B.

Interest Acquired: That of Rossett Pty Ltd (as Registered Proprietor), Tech-Rentals Pty Ltd (as Lessee) and all other interests.

Published with the authority of the Secretary to the Department of Infrastructure.

Dated 8 May 2003

For and on behalf of the Secretary
to the Department of Infrastructure:
GERRY TURNER,
Manager Property Services Department,
Roads Corporation.

Nurses Act 1993

On 17 April 2003, a panel appointed by the Nurses Board of Victoria, found that Richard Antony Bastida, identification number 1520311, registered in division 1, had engaged in unprofessional conduct of a serious nature.

The panel determined that:

1. pursuant to section 48(2)(g) **Nurses Act 1993**, the nurse's registration be suspended for one month, commencing on 30 April 2003;
2. pursuant to section 48(2)(d) of the Act, the nurse is required to undergo further education in professional ethics for nurses, the course or module and the institution to be approved in writing before tuition commences, the course or module to commence by 31 October 2003, and be completed by 30 April 2005.

LOUISE MILNE-ROCH
Chief Executive Officer

Nurses Act 1993

On 30 April 2003, a panel appointed by the Nurses Board of Victoria, found that Steven Henry Wright, identification number 1505794, registered in divisions 3 and 2, had engaged in unprofessional conduct of a serious nature.

The panel determined that:

1. pursuant to section 48(2)(g) **Nurses Act 1993**, the nurse's registration be suspended for three years, commencing on 7 May 2003;
2. after the period of suspension pursuant to paragraph 1 of this determination, the following conditions, limitations or restrictions shall be imposed on the nurse's registration pursuant to section 48(2)(e), until removed pursuant to paragraphs 3 or 4 of this determination;
 - (a) the nurse's practice must be supervised for 12 months;
 - (b) within seven months of the commencement of supervision, the nurse must provide the Board with a report of the first six months of his supervised practice;
 - (c) within 13 months of the commencement of supervision, the nurse must provide the Board with a report of the whole period of his supervised practice;
 - (d) the nurse must not work as a community psychiatric nurse;
3. if the reports of supervised practice provided pursuant to the conditions imposed under sub-paragraphs 2(b) and 2(c)

of this determination are satisfactory to the Board, then the conditions imposed by sub-paragraphs 2(a)–(c) must be removed at the next meeting of the Board after the later report is received;

4. the condition imposed under sub-paragraph 2(d) of this determination must be removed on the third anniversary of its imposition;
5. pursuant to section 48(2)(d) of the Act, the nurse be required to undergo further education in professional boundaries, the unit or module to be approved in writing by the Board before tuition commences, and to be satisfactorily completed within 12 months of the nurse's registration being restored after the suspension pursuant to paragraph 1 of this determination.

LOUISE MILNE-ROCH
Chief Executive Officer

Subordinate Legislation Act 1994

NOTICE OF PREPARATION OF REGULATORY IMPACT STATEMENT

Land Tax (Amendment) Regulations 2003

Notice is given in accordance with section 11 of the **Subordinate Legislation Act 1994** that a Regulatory Impact Statement (RIS) has been prepared in relation to the Land Tax (Amendment) Regulations 2003.

The proposed Regulations are made under the **Land Tax Act 1958**. The principal objectives of the proposed Regulations are to amend the Land Tax Regulations 1998 in respect of the prescribed fee for an application for a certificate of land tax due under Section 97 of the **Land Tax Act 1958**, and to introduce a tiered fee structure.

Under the new structure, the prescribed fee for an application made via the "Land Tax Clearance Certificates On Line" service available on the State Revenue Office (www.sro.vic.gov.au) website will be \$15. The prescribed fee for an application made in any other manner will be \$20.

A RIS has been prepared in accordance with the **Subordinate Legislation Act 1994**. This RIS examines the costs and benefits of the proposed Regulations and the possible alternatives, and concludes that the proposed Regulations provide the most efficient and effective means of achieving the objectives.

Copies of the RIS, and the proposed Regulations, can be obtained from the State Revenue Office, 505 Little Collins Street, Melbourne 3000, telephone 9628 6105, or downloaded from the State Revenue Office website www.sro.vic.gov.au.

Public comments are invited on the RIS and the proposed Regulations. Written submissions will be received until 5.00 pm on 5 June 2003. All submissions will be treated as public documents. Submissions should be addressed to: The Manager, Policy & Legislation Branch, State Revenue Office, 505 Little Collins Street, GPO Box 1641N, Melbourne 3001, or facsimile 03 9628 0576.

JOHN BRUMBY
Treasurer

Transport Act 1983
TOW TRUCK DIRECTORATE OF VICTORIA
Tow Truck Application

Notice is hereby given that the following application will be considered by the Licensing Authority after 11 June 2003.

Notice of any objection to the granting of an application should be forwarded to reach the Director, Tow Truck Directorate of Victoria, Level 6, 14–20 Blackwood Street, North Melbourne (PO Box 666, North Melbourne 3051) not later than 5 June 2003.

It will not be necessary for interested parties to appear on the date specified, unless advised in writing.

J. Ozolins. Application for variation of conditions of tow truck licence number TOW279 which authorises the licensed vehicle to be managed, controlled and operated from a depot situated at Upper Gundowring to change the depot address to Lot 4, Nelse Street, Mount Beauty.

Note: This Licence is under consideration for transfer to H. A. Jacob & Sons Pty Ltd.

Dated 8 May 2003

STEVE STANKO
Director

Flora and Fauna Guarantee Act 1988

The **Flora and Fauna Guarantee Act 1988** enables members of the public to nominate species, communities and potentially threatening processes for listing under the Act. Nominations under the Act are considered by a Scientific Advisory Committee, which makes recommendations to the Minister.

The Committee has made a number of final and preliminary recommendations. A Recommendation Report has been prepared for each final and preliminary recommendation. Copies of the reports can be obtained from the Head Office and major country offices of the Department of Sustainability and Environment (formerly NRE). The **Flora and Fauna Guarantee Act 1988** and the Flora and Fauna Guarantee Regulations 2001 can be viewed at these offices.

Submissions supplying evidence that confirm or contradict the preliminary recommendations will be accepted until 6 June 2003. Please note that the Scientific Advisory Committee considers only nature conservation issues.

There is no public comment period for final recommendations. Submissions marked CONFIDENTIAL should be sent to:

Scientific Advisory Committee, c/o Flora and Fauna Branch, Dept. Sustainability and Environment, 4/250 Victoria Pde. (PO Box 500), East Melbourne 3002.

For inquiries regarding the Flora and Fauna Guarantee Act please contact Martin O'Brien (03) 9412 4567. For information on specific items please contact Parks Flora & Fauna staff at DSE offices.

MARTIN O'BRIEN
Executive Officer, Scientific Advisory Committee.

FINAL RECOMMENDATIONS OF THE SCIENTIFIC ADVISORY COMMITTEE

The Scientific Advisory Committee has made final recommendations on the evidence available, in accordance with Section 15 of the Act, that the nominations for listing of the following items be supported or not supported in accordance with Section 11 of the **Flora and Fauna Guarantee Act 1988**.

Items supported for listing		Criterion/criteria satisfied
624 <i>Amphiura triscacantha</i>	Brittle Star species	1.2.1
633 <i>Atriplex acutibractea</i> ssp. <i>acutibractea</i>	Pointed Saltbush	1.2.1
636 <i>Atriplex holocarpa</i>	Pop Saltbush	1.2.1
637 <i>Atriplex limbata</i>	Spreading Saltbush	1.2.1
638 <i>Atriplex rhagodioides</i>	Silver Saltbush	1.2.1
648 <i>Candalides heathi</i> ssp. 'Wimmera form'	Rayed Blue Butterfly (Wimmera form)	1.2, 1.2.1
626 <i>Ophiocomina australis</i>	Brittle Star species	1.2.1
649 <i>Oreixenica latialis theddora</i>	Small Alpine Xenica Butterfly	1.2, 1.2.1
627 <i>Pernagera gatliffi</i>	Land Snail species	1.2.1
629 <i>Trochodota shepherdii</i>	Sea-cucumber species	1.2.1
647 Loss of coarse woody debris from Victorian native forests and woodlands (potentially threatening process)		5.1, 5.1.1

The reason that the nominations are supported is that the items satisfy at least one primary criterion of the set of criteria maintained under Section 11 of the Act and stated in Schedule 1 of the Flora and Fauna Guarantee Regulations 2001.

Item not supported for listing

632 <i>Litoria aurea</i>	Green and Golden Bell Frog	rejected
--------------------------	-------------------------------	----------

The reason that the nomination is not supported is the item does not satisfy at least one primary criterion of the set of criteria maintained under Section 11 of the Act.

PRELIMINARY RECOMMENDATIONS OF THE SCIENTIFIC ADVISORY COMMITTEE

The Scientific Advisory Committee has made preliminary recommendations on the evidence available, in accordance with Section 14 of the Act, that the nominations for listing of the following items be supported or not supported in accordance with Section 11 of the **Flora and Fauna Guarantee Act 1988**.

Items supported for listing		Criterion/criteria satisfied
651 <i>Abutilon oxycarpum</i> var. <i>malvaeifolium</i>	Mallow-leaf Lantern-flower	1.2.1

652 <i>Botrychium australe</i>	Austral Moonwort	1.1, 1.2, 1.2.1
654 <i>Cyperus rigidellus</i>	Dwarf Flat-sedge	1.2.1
655 <i>Deyeuxia affinis</i>	Allied Bent-grass	1.2.1
662 <i>Jalmenus icilius</i>	Amethyst Hairstreak Butterfly	1.1, 1.2, 1.2.1
656 <i>Juncus antarcticus</i>	Cushion Rush	1.2, 1.2.1
657 <i>Sclerolaena ventricosa</i>	Salt Copperburr	1.2.1
Item not supported for listing		
653 <i>Callitriche umbonata</i>	Winged Water-starwort	rejected

The reason that the nomination is not supported is the item does not satisfy at least one primary criterion of the set of criteria maintained under Section 11 of the Act.

Preparation of Action Statements

Under Section 19 of the **Flora and Fauna Guarantee Act 1988**, the Secretary to the Department of Sustainability and Environment is required to prepare an Action Statement (or management plan) for each listed item. Action Statements set out what has been done and what is intended to be done to conserve or manage that item.

Groups or individuals wishing to comment on a particular action statement at the draft stage, if and when the above items are listed by the Governor in Council on the recommendation of the Minister, should express their interest to:

Rod Gowans, Director Flora and Fauna, Dept. Sustainability and Environment, PO Box 500, East Melbourne 3002.

Transport Act 1983

ROAD DECLARATIONS AND DEDICATIONS

The Roads Corporation pursuant to the **Transport Act 1983**, upon publication of this notice declares, varies or rescinds the declaration of the roads or parts of the roads, as described in the Schedule and on the plans attached, and further declares that the roads or parts of the roads which are declared by this notice are fit to be used as a public highway and are now absolutely dedicated to the public for use as a public highway within the meaning of any law now or hereafter in force.



SCHEDULE

MAIN ROAD

- a) Those parts of Pascoe Vale Road in the City of Moreland and City of Hume identified by hatching on the plan numbered GP 18798. The road or parts of the road are declared as described in the legend on the said plan.
- b) Those parts of Heidelberg–Kingslake Road and Kangaroo Ground–St Andrews Road in the Shire of Nillumbik identified by hatching on the plans numbered GP20421 and GP20421A. The road or parts of the road are declared and/or rescinded as described in the legend on the said plans.
- c) Those parts of Keilor Park Drive in the City of Brimbank identified by hatching on the plans numbered GP 18876 and GP 19187. The road or parts of the road are declared as described in the legend on the said plans.
- d) Those parts of Beechworth–Wangaratta Road in the Shire of Indigo identified by hatching on the plan numbered GP 20215. The part of the road is rescinded as described in the legend on the said plan.

ROAD

- e) Deanside Drive in the Shire of Melton identified by hatching on the plan numbered GP 10312. The road is declared as described in the legend on the said plan.

-  DECLARE
Parcel 1 on SP18798
-  DECLARE OVER WESTERN RING ROAD
Parcels 2 on SP18798

ROADS CORPORATION
MAIN ROAD
PASCOE VALE ROAD
 CITY OF HUME
 CITY OF MORELAND

GP 18798
 Compiled from
 SP18798

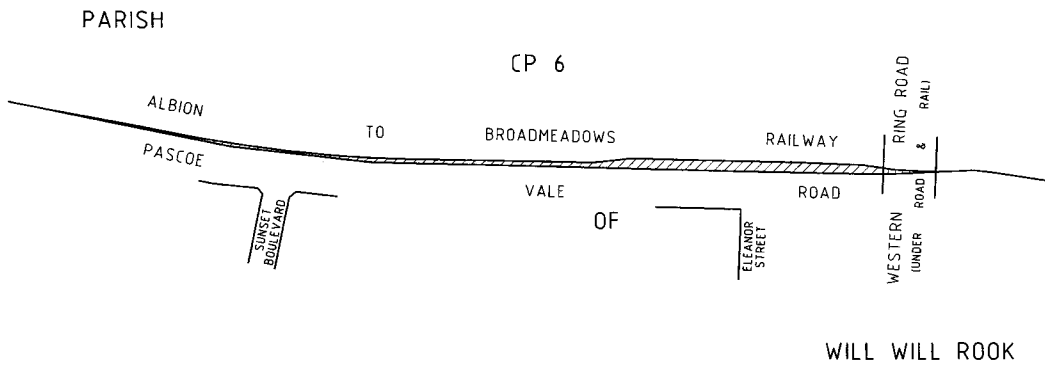

ROADS CORPORATION
MAIN ROAD
HEIDELBERG-KINGLAKE ROAD
 SHIRE OF NILLUMBIK

- LEGEND
-  DECLARE
Parcels 1 & 3 on SP20421

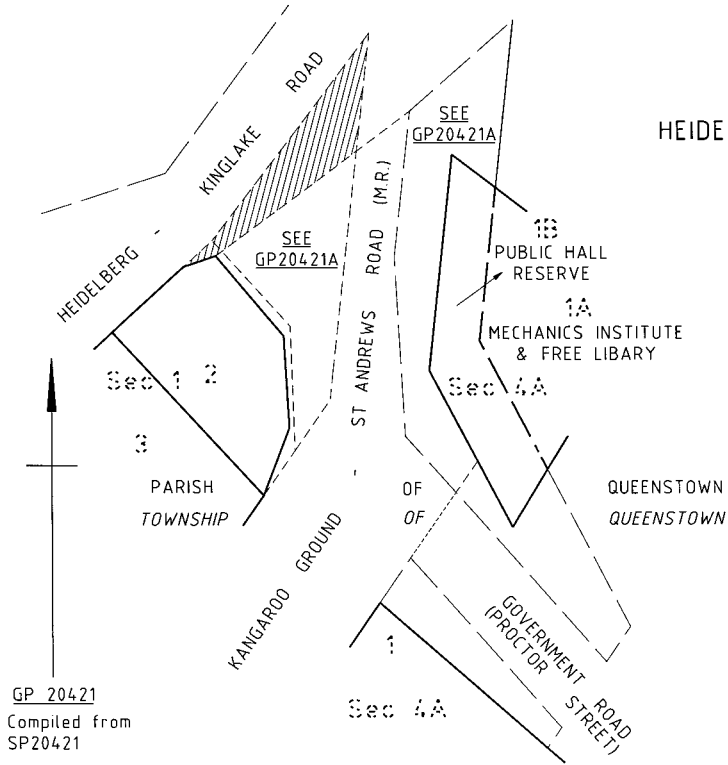

GP 20421
 Compiled from
 SP20421

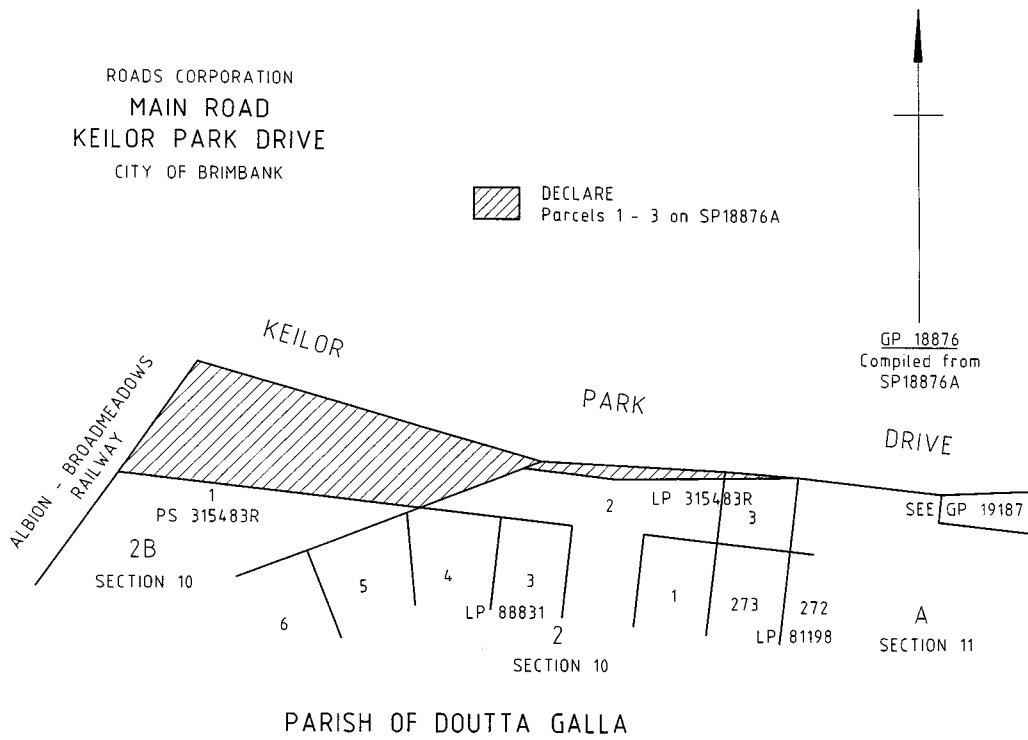
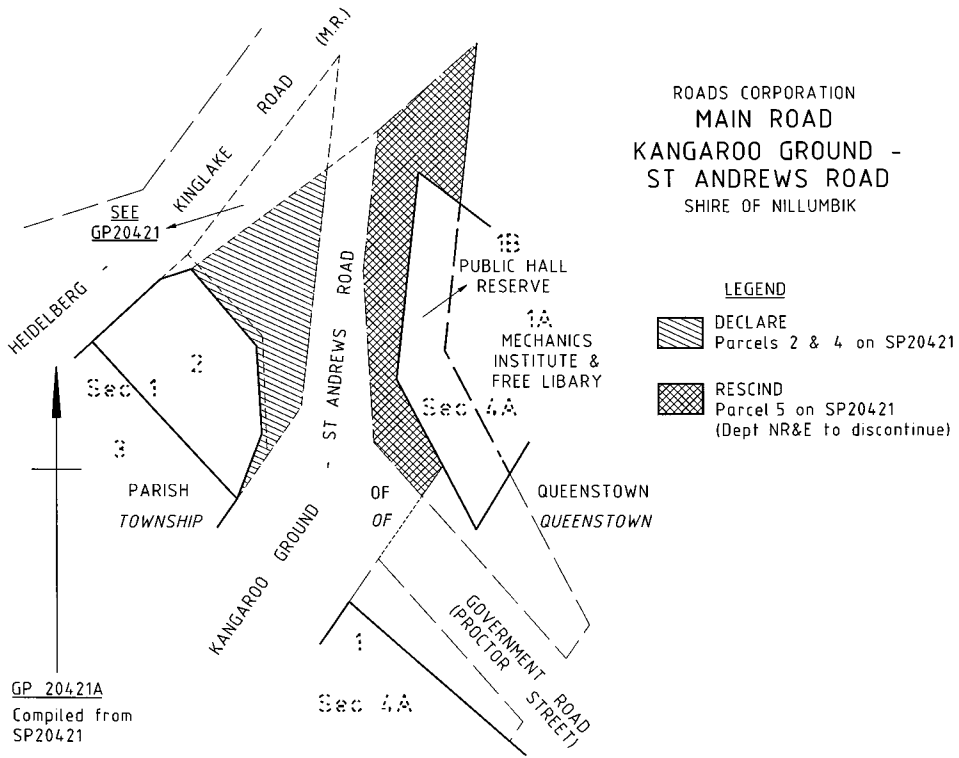

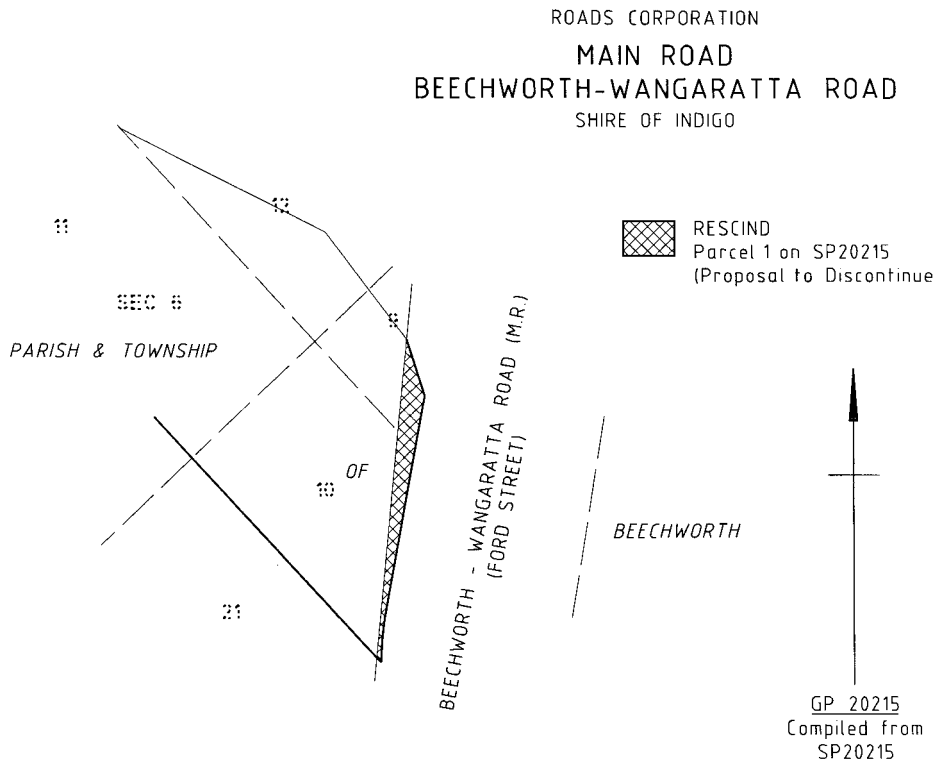
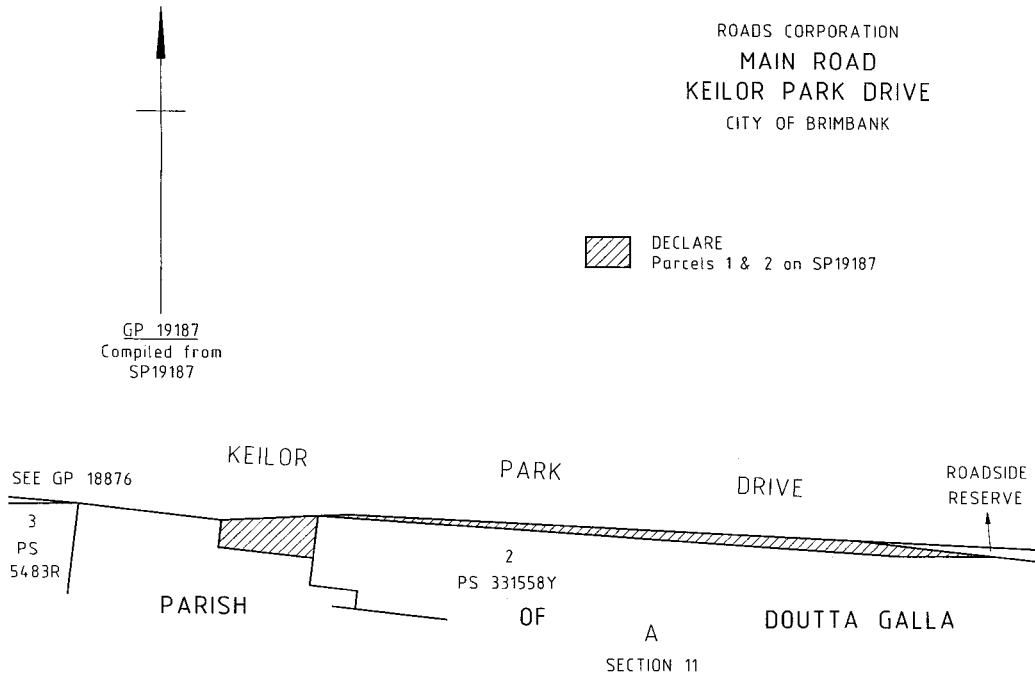

ROADS CORPORATION
DEANSIDE DRIVE
SHIRE OF MELTON

 DECLARE
as shown on SP10312

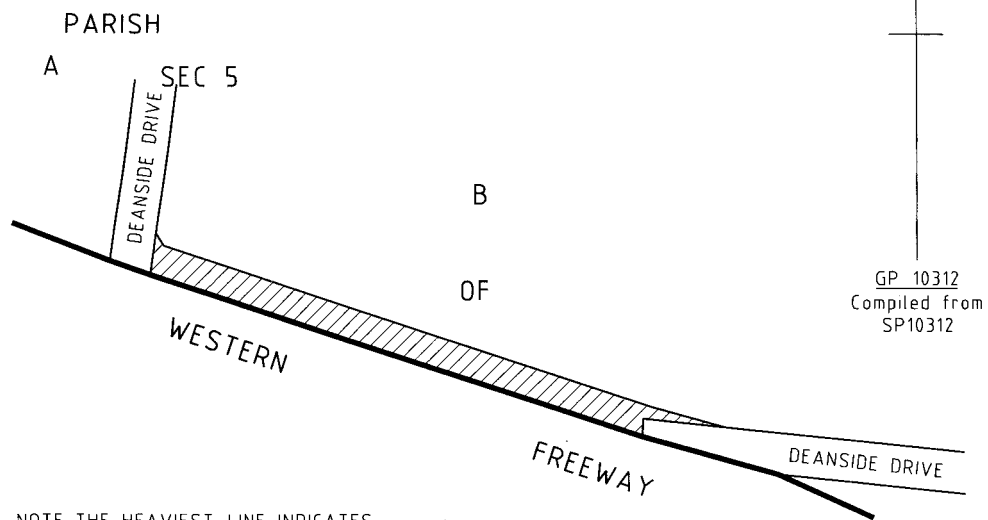

NOTE: THE HEAVIEST LINE INDICATES
A restriction of access.
The limits of the Freeway Reservation.

KOROROIT

Dated 5 May 2003

DAVID ANDERSON
Chief Executive
Roads Corporation

Transport Act 1983

DISCONTINUANCE OF ROADS OR PARTS OF ROADS

The Roads Corporation, in pursuance of the powers conferred by Clause 2, Schedule 4 of the **Transport Act 1983**, hereby approves the discontinuance of the roads or parts of the roads as described in the Schedule and on the plan attached, and approves the sale of the surplus land as provided in Section 47 of the **Transport Act 1983** and as delegated by the Minister for Transport under Section 32 of the said Act.

SCHEDULE

- a) The land in the Shire of Indigo described as Formerly Beechworth–Wangaratta Road in the Township and Parish of Beechworth, referred to on the plan numbered RD20215. The part of the road described in the legend on the said plan is discontinued.

ROADS CORPORATION
FORMERLY BEECHWORTH-WANGARATTA ROAD
 SHIRE OF INDIGO

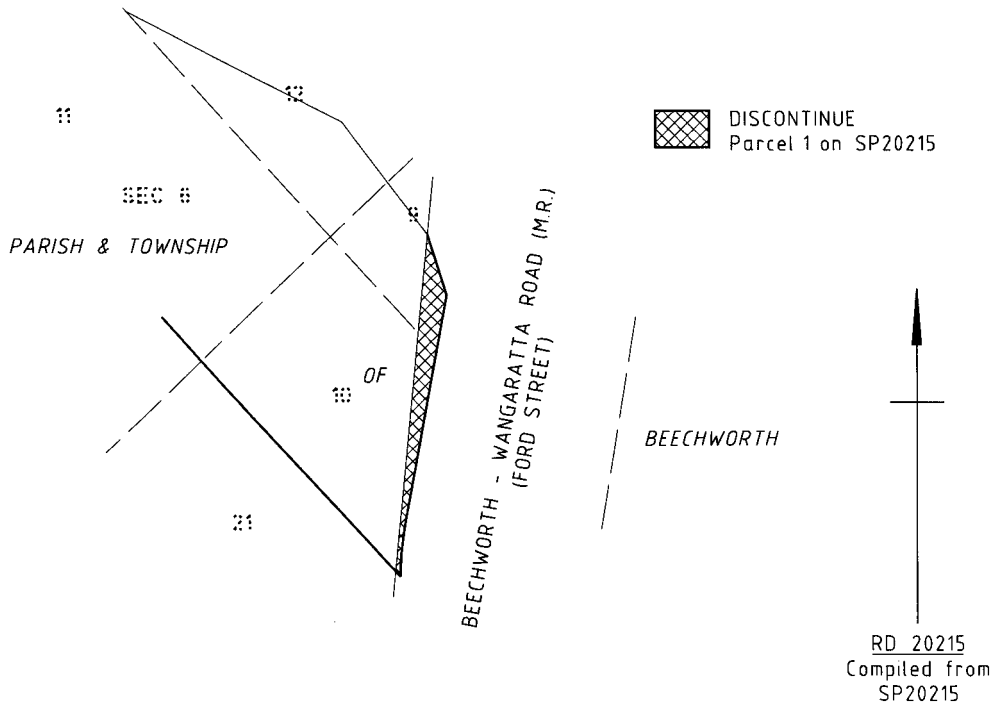

Dated 5 May 2003

DAVID ANDERSON
 Chief Executive
 Roads Corporation

SURVEYORS REGISTERED IN VICTORIA AS AT MARCH 2003

<i>Registration Number</i>	<i>Registration Date</i>	<i>Licensed Surveyor Date</i>	<i>Name</i>	<i>Address</i>
1152	14-Feb-69	14-Feb-69	Abbott, John A	74 Wallis Avenue, Strathfield, NSW 2135
1625	21-May-87	21-May-87	Ablett, Christopher John	19 Weingarth Street, Holder, ACT 2611
1162	26-Jun-69	26-Jun-69	Abram, Colin William	7 Koonangurt Road, Leopold, Vic. 3224
1315	15-May-75	15-May-75	Adams, Kenneth Douglas	8 Borona Court, Croydon, Vic. 3136
929	04-Jul-60	04-Jul-60	Adamson, Graeme Clifford	PO Box 115, Lilydale, Vic. 3140
831	23-Jan-56	23-Jan-56	Adderly, Douglas Ian	175 Blackburn Road, Doncaster East, Vic. 3109
1041	19-Mar-65	19-Mar-65	Adkins, Leslie Roland	20 One Chain Road, Arawata, Vic. 3951
730	20-Oct-49	20-Oct-49	Adshead, Jack	73 Pellath Street, Beaumaris, Vic. 3193
1646	25-Oct-88	25-Oct-88	Aiello, Danny	28 Prospect Road, Bulleen, Vic. 3105
1723	26-Oct-94	26-Oct-94	Aitken, William McIver	16 Pinnock Street, Bairnsdale, Vic. 3875
1388	11-Aug-77	11-Aug-77	Alexander, Ian Charles	PO Box 1007, Mt. Barker, SA 5251
1267	21-Mar-74	21-Mar-74	Alldis, Phillip A.	2 Merriwa Street, Gordon, NSW 2072
1781	27-Jun-00	27-Jun-00	Allen, Anthony Richard	102 Crown Street, Woolloomooloo, NSW 2011
1017	06-Jul-64	06-Jul-64	Allens, Eriks	142 Como Parade West Parkdale, Vic. 3194
1387	11-Aug-77	11-Aug-77	Almond, Peter Thomas Edmund	47 Baker Parade Ashburton, Vic. 3147
1827	18-Feb-03	18-Feb-03	Anderson, Mark Adrian	PO Box 237, Watsonia, Vic. 3087
1755	18-Mar-97	18-Mar-97	Anderson, Ralph Ian	PO Box 2037, Berri, SA 5343
1231	20-Jul-72	20-Jul-72	Andrew, Robert Lindsay	276 Flinders Street, Adelaide, SA 5000
1731	05-Dec-94		Aravanis, Zois	21 Graham Street, Pascoe Vale South, Vic. 3044
1009	20-Mar-64	20-Mar-64	Archer, John Charles	8 Carboni Court, Mulgrave, Vic. 3170

1698	29-Apr-92	29-Apr-92	Argus, Susan	54 Lemon Avenue, Mildura, Vic. 3500
869	19-Nov-57	19-Nov-57	Armstrong, John G.	105/2 Kitchener Street, St Ives, NSW 2075
1206	11-Nov-71	11-Nov-71	Armstrong, Richard John	697 Morningside Place, Albury, NSW 2640
897	04-May-59	04-May-59	Arrowsmith, Henry Thomas	11 Clonmult Avenue, Highett, Vic. 3190
1037	26-Feb-65	26-Feb-65	Arter, John Joseph Lewis	24 Cassowary Street, Doncaster East, Vic. 3109
828	25-Nov-55	25-Nov-55	Ascott, Kenneth Francis	15 Gaffney Street, Castlemaine, Vic. 3450
860	11-Oct-57	11-Oct-57	Ashworth, Alfred R.	Address unknown
1793	10-Apr-01	10-Apr-01	Atkinson, Philip John	9 Tennyson Street, Kensington, Vic. 3031
1105	27-Jun-67	27-Jun-67	Aujard, Rodney	311 Burwood Road, Hawthorn, Vic. 3122
953	09-Jun-61	09-Jun-61	Austin, David Llewellen	145 Leila Road, Carnegie, Vic. 3163
1118	27-Jun-67	27-Jun-67	Avery, Peter James	570 Orrong Road, Armadale, Vic. 3143
1369	16-Dec-76	16-Dec-76	Avery, Thomas Leslie	69 Cook Street, North Ward, Qld 4810
1655	02-May-89	02-May-89	Backholer, Kim Laurence	1 Alexander Street, Emerald, Vic. 3782
1246	08-May-73	08-May-73	Baggoley, John David	13 Felgate Parade, Vermont South, Vic. 3133
998	05-Dec-63	05-Dec-63	Bailey, Michael Edmund	68 Foch Street, Box Hill South, Vic. 3128
792	14-Oct-53	14-Oct-53	Bain, Alexander Maurice	1/12 Edgar Street, Werribee, Vic. 3030
1254	13-Dec-73	13-Dec-73	Bain, Trevor Edward	17 Ashwood Court, Sunnybank Hills, Qld 4109
1604	13-May-86	13-May-86	Baird, Timothy John Gartlan	15 Monaghan Road, Gisborne, Vic. 3437
835	23-May-56	23-May-56	Baker, Kenneth Arthur	32 Pine Crescent, Ringwood, Vic. 3134
1470	24-Apr-80	24-Apr-80	Bakunowicz, Alexander	17 Buchanan Terrace, Nakara, NT 810
1327	14-Aug-75	14-Aug-75	Barge, Kevin J.	2/2 Claremont Street, South Yarra, Vic. 3141
1373	10-Feb-77	10-Feb-77	Barker, Ian David	35 Everton Grove, Surrey Hills, Vic. 3127
686	02-Apr-47	02-Apr-47	Barker, Ronald John	12 Sheffield Street, Preston, Vic. 3072

1820	23-Oct-02	23-Oct-02	Barker, Robert William	1226/422 Collins Street, Melbourne, Vic. 3000
1423	04-Oct-78	04-Oct-78	Barnett, Robert W. G.	3 Wilson Street, Wodonga, Vic. 3690
1745	12-Dec-95	12-Dec-95	Bateman, Leo Alexander	13 Jack Street, Newport, Vic. 3015
966	15-Jun-62	15-Jun-62	Bauer, Frederick J.	3 Nyora Road, Eltham, Vic. 3095
1294	16-Jan-75	16-Jan-75	Bawden, Richard H.	Address unknown
1359	11-Nov-76	11-Nov-76	Baxter, Michael John	26 Dowling Street, Wonthaggi, Vic. 3995
1676	16-May-90	16-May-90	Beavis, Alan Leslie	60 Denmark Street, Kew, Vic. 3101
1601	13-May-86	13-May-86	Beavis, Neville David	1930 Old Noosa Road, Traverston, Qld 4570
912	17-Nov-59	17-Nov-59	Beddoe, John William	5 Jacqueline Road, Mount Waverley, Vic. 3149
784	05-Jun-53	05-Jun-53	Behan, Brian P. J.	15 Woods Street, Kennington, Vic. 3550
776	14-Nov-52	14-Nov-52	Belcher, John Jamieson	54 Confederation Villas, N.W. Calgary, Alberta T2L-2KP, Canada
1770	17-Aug-99	17-Aug-99	Bell, Keith Clifford	15/570 Bourke Street, Melbourne, Vic. 3000
774	14-Nov-52	14-Nov-52	Bell, Peter David	'Netherlea', 37 Bay Road, Sandringham, Vic. 3191
1038	26-Feb-65	26-Feb-65	Bennett, Desmond John	PO Box 157, Forest Hill, Vic. 3131
994	02-Jul-63	02-Jul-63	Bennett, James Henry	118 Drevermann Street, Bairnsdale, Vic. 3875
1512	20-Oct-81	20-Oct-81	Bennett, Peter George	73 Berringa Road, Park Orchards, Vic. 3114
1440	06-Apr-78	06-Apr-78	Bennett, Stephen	PO Box 1013, Goulburn, NSW 2580
1513	20-Oct-81	20-Oct-81	Bent, Ian Alfred	76 Little Ryrie Street, Geelong, Vic. 3220
1291	12-Dec-74	12-Dec-74	Benwell, George L.	18 Renown Street, Bentleigh, Vic. 3204
1358	11-Nov-76	11-Nov-76	Berry, Geoffrey D.	PO Box 168, Brunswick, Vic. 3056
1300	20-Feb-75	20-Feb-75	Berry, Richard Henry	PO Box 674, Portland, Vic. 3305
1006	29-Jan-64	29-Jan-64	Bertacco, John Peter	69 Crawford Road, Clarinda, Vic. 3169
1725	26-Oct-94		Bertuch, James Robert	18 Cherry Crescent, Morwell, Vic. 3840

898	08-May-59	08-May-59	Beveridge, Ralph Anthony	18 Dudley Street, Brighton, Vic. 3186
1238	21-Sep-72	21-Sep-72	Bienias, John	37 Talbot Avenue, Balwyn, Vic. 3103
1178	07-Sep-70	07-Sep-70	Biesterbos, Hendrik Hank	PO Box 580, Baguio City 2600 Philippines
1486	16-Oct-80	16-Oct-80	Billows, Ian James	PO Box 2652, Cairns, Qld 4870
1218	04-May-72	04-May-72	Bird, David Edward	460 Hawthorn Road, Caulfield South, Vic. 3162
1084	18-Jul-66	18-Jul-66	Birrell, Graeme D.	Address unknown
1772	14-Dec-99	14-Dec-99	Birzulis, Eriks Ivars	24 Haines Street, Hawthorn, Vic. 3122
894	01-May-59	01-May-59	Bishop, Ian Geoffrey	50 Mimosa Avenue, Alfredton, Vic. 3350
919	26-May-60	26-May-60	Bishop, Roy	Address unknown
713	18-Oct-48	18-Oct-48	Blackburn, James A. D.	4 McHale Court, Essendon, Vic. 3040
1514	20-Oct-81	20-Oct-81	Blackburn, Michael A.	9 Albert Road, Carnegie, Vic. 3163
1204	03-Sep-71	03-Sep-71	Blackley, Philip Raymond	49 George Street, East Maitland, NSW 2323
801	27-Apr-54	27-Apr-54	Blackley, William James	16 Almay Grove, Heidelberg, Vic. 3084
1301	26-Feb-75	26-Feb-75	Blackwood, Christopher Neil	56 Weerona Way, North Warrandyte, Vic. 3113
1224	19-Jun-72	19-Jun-72	Blair, John D.	Address unknown
1450	18-Oct-79	18-Oct-79	Boardman, Christopher J.	9 Bernborough Place, Mill Park, Vic. 3082
1025	09-Dec-64	09-Dec-64	Boatwright, Graham Ernest	62 Palmer Avenue, Golden Beach, Qld 4551
1750	21-Jun-96	21-Jun-96	Boey, See Seng	27 Hope Street, West Preston, Vic. 3072
1822	23-Oct-02	23-Oct-02	Bond, Stephen Francis	350 Balaclava Road, Caulfield North, Vic. 3161
1718	27-Apr-94	27-Apr-94	Bortoli, Robert Gaetano	84 Bath Road, Glen Iris, Vic. 3146
1451	18-Oct-79	18-Oct-79	Bosco, Francis	4 Braeside Avenue, Rosanna, Vic. 3084
829	25-Nov-55	25-Nov-55	Boston, Arthur G.	Address unknown
1636	16-Feb-88	16-Feb-88	Bourne, Kent Ronald	1/6 Croydon Road, Paddington, Qld 4064
986	25-Jun-63	25-Jun-63	Bourne, Kevin Thaddeus	38 Vincent Street, Glen Iris, Vic. 3146

1515	20-Oct-81	20-Oct-81	Bowden, Bruce Ian	PO Box 947, Bairnsdale, Vic, 3875
1509	07-May-81	07-May-81	Boyd, Terence John	Suite 312, 370 St. Kilda, Melbourne, Vic. 3004
1424	04-Oct-78	04-Oct-78	Boyle, David Richard	PO Box 218, Preston, Vic. 3072
701	09-Apr-48	09-Apr-48	Bradbury, Neil Harry	PO Box 207, Maffra, Vic. 3860
1549	28-Apr-83	28-Apr-83	Brayley, Neville Leonard	2 Westacott Street, Hamilton, Vic. 3300
1277	08-Aug-74	08-Aug-74	Bremner, Barrie William	Level 11, 570 Bourke St, Melbourne, Vic. 3000
859	30-Sep-57	30-Sep-57	Briggs, Richard	49 Tomah Street, Carlingford, NSW 2118
1773	14-Dec-99	14-Dec-99	Bright, Anthony Edward	26 Murray Street, Colac, Vic. 3250
1296	16-Jan-75	16-Jan-75	Bright, Rodney Arthur	26 Murray Street, Colac, Vic. 3250
666	17-Apr-45	17-Apr-45	Brittain, William G.	Lot 47, Gladstone Drive, Serpentine, WA 6205
1299	20-Feb-75	20-Feb-75	Britten, Ernest J.	PO Box 171, Smithfield, NSW 2164
1563	17-Apr-84	17-Apr-84	Broadbent, Daniel Joseph	3 Riverview Road, Montmorency, Vic. 3094
1507	07-May-81	07-May-81	Brodzik, Jon M.	565 Bairnsdale–Dargo Road, Bairnsdale, Vic. 3875
1730	05-Dec-94	05-Dec-94	Brooks, Duncan Lindsay	27 Myrtle Road, Canterbury, Vic. 3126
681	15-Apr-47	15-Apr-47	Brown, Alan John	4 Baldwin Avenue, Upper Ferntree Gully, Vic. 3156
684	14-Apr-47	14-Apr-47	Brown, Allan Cedric	118A Salford Pk, 100 Harold Street, Wantirna, Vic. 3152
724	22-Apr-49	22-Apr-49	Brown, Donald A.	7 Charles Street, Brighton East, Vic. 3187
1422	06-Jul-78	06-Jul-78	Brown, Graham L.	Address unknown
1554	21-Jul-83	21-Jul-83	Brown, Jeffrey George	172 Rossi Street, Yass, NSW 2582
761	30-Nov-51	30-Nov-51	Brown, John W. G.	PO Box 59, Mittagong, NSW 2575
1795	24-Apr-01		Brown, Peter James	1A Parkview Road, Brighton East, Vic. 3187
1618	19-Feb-87	19-Feb-87	Browne, Richard Leslie	5 Manoora Place, Kenwick, WA 6107

1463	22-Nov-79	22-Nov-79	Browne, William Anderson	2/42 Durham Street, Glenelg, SA 5045
1189	25-Feb-71	25-Feb-71	Bruce, John Robert	38 Kandana Grove, Bulleen, Vic. 3105
1532	20-May-82	20-May-82	Bruinhout, John A.	17 Coleman Avenue, Mildura, Vic. 3500
1751	16-Aug-96	16-Aug-96	Buchanan, Andrew E.	4A O'Connell Street Richmond, Vic. 3121
878	06-May-58	06-May-58	Buckley, John Francis	15 Howie Street, Glen Iris, Vic. 3146
1767	16-Feb-99	16-Feb-99	Buckley, Kenneth George	PO Box 1134, Lismore, NSW 2480
1626	17-Sep-87	17-Sep-87	Burnett, Kenneth William	PO Box 41, Helensvale, Qld 4212
1548	10-Mar-83	10-Mar-83	Burns, Peter William	PO Box 737, Cooma, NSW 2630
1818	22-Aug-02	22-Aug-02	Busse, Andrew John	182 Wiltshire Drive, Kew, Vic. 3101
1643	19-Jul-88	19-Jul-88	Caddey, James William	PO Box 72, Corowa, NSW 2646
1560	27-Oct-83	27-Oct-83	Caddey, Victor Paul	167 Broadwater Terrace, Redland Bay, Qld 4165
1306	28-Feb-75	28-Feb-75	Caldwell, Lea	PO Box 319, Drouin, Vic. 3818
1389	11-Aug-77	11-Aug-77	Calnan, Graeme Geoffrey	PO Box 766, Coffs Harbour, NSW 2450
1018	17-Jul-64	17-Jul-64	Cameron, William Napier	58 Eighth Street, Parkdale, Vic. 3194
749	18-Apr-51	18-Apr-51	Campbell, Bruce Alexander	22 Poath Road, Hughesdale, Vic. 3166
1059	04-Feb-66	04-Feb-66	Campbell, Kim Gypson	PO Box 888, Yackandandah, Vic. 3749
1694	09-Dec-91	09-Dec-91	Canning, James Charles	1 Oxley Road, Hawthorn, Vic. 3122
698	13-Oct-47	13-Oct-47	Carpenter, Ian	7/70 Prince Street, Orange, NSW 2800
1057	15-Dec-65	15-Dec-65	Carroll, Brian Francis	3 Peter Court, Seaford, Vic. 3198
874	05-May-58	05-May-58	Carroll, Leon F. X.	20 Briggs Street, Mount Waverley, Vic. 3149
1540	18-Nov-82	18-Nov-82	Carson, Clifford Charles	PO Box 47, Cranbourne, Vic. 3977
1156	09-Apr-69	09-Apr-69	Carson, Clive Henry	47 Maxwell Street, New Farm, Qld 4005

1372	10-Feb-97	10-Feb-97	Carter, Jack Frederick	3 Julianne Street, Busselton, WA 6280
1081	15-Jul-66	15-Jul-66	Carter, Richard Dennis	2 Munster Court, Endeavour Hills, Vic. 3802
1125	10-Nov-67	10-Nov-67	Casey, William Thomas	4/5 Olive Grove, Mount Clear, Vic. 3350
997	18-Jul-63	18-Jul-63	Cathels, Galety William	36 Shiels Terrace, Casterton, Vic. 3311
882	20-Oct-58	20-Oct-58	Cavill, James Ranfield	21 Craighill Road, St Georges, SA 5064
1346	06-May-76	06-May-76	Chalmers, Gregory	30 Bellerine Street, Geelong, Vic. 3220
1054	09-Dec-65	09-Dec-65	Chambers, Ian John	11A Carween Avenue, Mitcham, Vic. 3132
1183	25-Jan-71	25-Jan-71	Chapman, Peter Thomas	32 Tudor Court, Edithvale, Vic. 3196
1524	29-Oct-81	29-Oct-81	Chapman, Rodney John	8 Jessamber Court, Diamond Creek, Vic. 3089
1064	24-Dec-65	24-Dec-65	Charrett, Peter Lawrence	P.O. Box 279, Moorebank, NSW 1875
1036	26-Feb-65	26-Feb-65	Cheah, Cheng B.	31A Suva Crescent, Greenacre, NSW 2190
1435	09-Nov-78	09-Nov-78	Chee, Timothy Shui Yong	PO Box 126, Likas 89407, Malaysia
1210	03-Dec-71	03-Dec-71	Chin, Kevin Sue Sun	PO Box 1809, Darwin, NT 801
1099	26-Jun-67	26-Jun-67	Chinchen, John Howard	2004 Fairmont House, 8 Cotton Tree Drive, Hong Kong, SAR China
1317	15-May-75	15-May-75	Chivers, Arnold C.	10 Fullview Court, Templestowe, Vic. 3106
1516	20-Oct-81	20-Oct-81	Chivers, John Edwin	1st Floor, 260 Main Street, Lilydale, Vic. 3140
1049	10-Sep-65	10-Sep-65	Chng, Teong Eam	#02-01 0279 Balester Road, 329797 Singapore
1000	05-Dec-63	05-Dec-63	Christey, Robert B.	39 Tagell Road, Ringwood East, Vic. 3135
1693	09-Dec-91	09-Dec-91	Cichocki, Eddie Stefan	Level 15, 570 Bourke St, Melbourne, Vic. 3000
1736	20-Jun-95	20-Jun-95	Cirillo, Richard Peter	4 Trentham Street, Sandringham, Vic. 3191
1815	26-Jun-02	26-Jun-02	Cirugeda, Andreas	8/53 Grove Street, Hawthorn, Vic. 3122
1378	21-Apr-77	21-Apr-77	Clancy, Gary Michael	12 Yeramba Close, Bendigo, Vic. 3550

1188	26-Jan-71	26-Jan-71	Clark, Maxwell George	402-406 Mair Street, Ballarat, Vic. 3350
1379	21-Apr-77	21-Apr-77	Clarke, Andrew Leigh	DISR GPO Box 9839, Canberra, ACT 2601
1079	13-Jul-66	13-Jul-66	Clarke, David Francis	4/179 Boronia Road, Boronia, Vic. 3155
1645	13-Sep-88	13-Sep-88	Clarke, Douglas C.	P.O. Box 1794, Wollongong, NSW 2500
799	26-Apr-54	26-Apr-54	Clarke, Edmond Henry	21 Morshead Avenue, Mount Waverley, Vic. 3149
1665	24-Jan-90	24-Jan-90	Clarke, Russell Alexander	Address unknown
742	16-Oct-50	16-Oct-50	Clarke, Stanleigh Richard	82 Carr Street, Barwon Heads, Vic. 3227
1712	15-Dec-93	15-Dec-93	Clayton, Murray Alan	439 Gore Street, Fitzroy, Vic. 3065
1786	19-Sep-00	19-Sep-00	Cleary, Mark John	15/570 Bourke Street, Melbourne, Vic. 3000
1581	14-Feb-85		Cleaves, Richard	80 Thompson Road, Drouin South, Vic. 3818
920	27-Jun-60	27-Jun-60	Cleland, Roger James Graeme	Bag 83, Currie, King Island, Tas. 7256
938	16-Dec-60	16-Dec-60	Clifton, John Xavier	2 Tourello Road, Mount Eliza, Vic. 3930
904	13-Nov-59	13-Nov-59	Cocks, Graeme J.	Address unknown
1235	04-Aug-72	04-Aug-72	Cohen, Christopher John	Cohen & Associates P/L PO Box 990, Launceston, Tas. 7250
1329	11-Sep-75	11-Sep-75	Cole, Gustav Silas Tertius	82 Bedford Road, Ringwood East, Vic. 3135
1670	24-Jan-90	24-Jan-90	Colebatch, Alistair	107 Lemont Avenue, Mt Waverley, Vic. 3149
941	09-Jan-61	09-Jan-61	Coleman, John Richard	2 St Bridgets Rise, North Balwyn, Vic. 3104
1591	15-Oct-85	15-Oct-85	Coles, Gary Peter	PO Box 63, Blackburn, Vic. 3130
1678	23-Oct-90		Collier, Philip Andrew	25 View Hill Crescent, Eltham, Vic. 3095
1789	04-Dec-00	04-Dec-00	Collins, Glenn Stuart	PO Box 416, Shepparton, Vic. 3632
862	08-Nov-57	08-Nov-57	Comber, Richard F.	55 Lakeside Road, Churchlands, WA 6018
1583	23-Apr-85	23-Apr-85	Connelly, Stewart John	5 Weeroona Street, Hampton, Vic. 3188

952	09-Jun-61	09-Jun-61	Connelly, William Noel	Old Sale Road, Westbury via Moe, Vic.3825
649	30-Sep-40	30-Sep-40	Connolly, Thomas M.	24 Blair Avenue, Frankston, Vic. 3199
759	22-Oct-51	22-Oct-51	Cook, Geoffrey Page	6/1 Hamilton Road, Malvern, Vic. 3144
1163	27-Jun-69	27-Jun-69	Cook, Rodney James Prescott	5 Moness Place, Shelley, WA 6148
1425	04-Oct-78	04-Oct-78	Cooksley, Arthur Lewis	429 Sandy Road, Rye, Vic. 3941
1316	15-May-75	15-May-75	Cooper, Geoffrey Leslie	2 Manooka Court, Greensborough, Vic. 3088
1529	04-May-82	04-May-82	Cooper, Gerard John	6 Neptune Court, Paradise Waters, Qld 4217
1205	03-Sep-71	03-Sep-71	Cooper, Michael D.	P.O.Box 79, Mole Creek, Tasmania 7304
1007	28-Feb-64	28-Feb-64	Corry, Maxwell John	23 Riverside Avenue, Balwyn North Vic. 3104
1584	23-Apr-85	23-Apr-85	Coultas, Geoffrey Bruce	59 Myrtle Road, Seacliff, SA 5049
901	15-May-59	15-May-59	Cox, Denis John	32 Tambet Street, Bentleigh East, Vic. 3165
1791	20-Mar-01	20-Mar-01	Cox, Simon Patrick	GPO Box 5175AA, Melbourne, Vic. 3001
911	17-Nov-59	17-Nov-59	Coxhill, Rex James	33 Northcote Street, Rochester, Vic. 3561
1347	06-May-76	06-May-76	Coxon, Peter H.	11 Longmore Street, West St Kilda, Vic. 3182
1244	02-Mar-73	02-Mar-73	Craig, Andrew Clifford	2 Kepeto Court, Mildura, Vic. 3500
1497	18-Dec-80	18-Dec-80	Crane, Philip John	9 Derby Street, Camberwell, Vic. 3124
1375	27-Jan-77	27-Jan-77	Crane, William George	PO Box 2108, Geelong, Vic. 3220
1087	05-Aug-66	05-Aug-66	Crawford, Paul	164 McIlwraith Ave, Norman Park, Qld 4170
842	08-Nov-56	08-Nov-56	Crichton, Neil J.	57 Garrick Street, Coolangatta, Qld 4225
1442	26-Apr-79	26-Apr-79	Cross, Robert Arthur	30 Pine Street, East Brighton, Vic. 3187
1505	07-May-81	07-May-81	Crowe, Paul Denis	192 Koroit Street, Warrnambool, Vic. 3280
693	21-Apr-47	21-Apr-47	Culliver, Francis Edward	36 Carbine Street, Donvale, Vic. 3111
1408	13-Apr-78	13-Apr-78	Culliver, Francis James	9 Clee Street, McKinnon, Vic. 3204

1019	30-Jun-64	30-Jun-64	Cullum, Alan James	11/13 Normandy Crescent, Ocean Grove, Victoria 3226
1556	27-Oct-83	27-Oct-83	Culvenor, Philip Francis	4 Sellers Street, Glen Waverley, Vic. 3150
1331	11-Dec-75	11-Dec-75	Cummins, Adrian John	PO Box 764, Strathfieldsaye, Vic. 3551
1089	28-Oct-66	28-Oct-66	Curdie, John Kirkwood	18 Albert Road, Beecroft, NSW 2119
1771	21-Sep-99	21-Sep-99	Dabelstein, Owen Michael	5/204 Clarke Street, Northcote, Vic. 3070
1452	18-Oct-79	18-Oct-79	Danson, Peter Robert	PO Box 2821, Mildura, Vic. 3502
975	15-Jun-62	15-Jun-62	Davey, John James	3/32 Tennyson Stret, Sandringham, Vic. 3191
923	27-Jun-60	27-Jun-60	Davies, Peter Francis	5 Portsmouth Street, Mount Waverley, Vic. 3149
1073	04-Jul-66	04-Jul-66	Davis, Andrew Elderton	1 Rooks Road, Nunawading, Vic. 3131
1380	21-Apr-77	21-Apr-77	Dawson, Gary T.	13 Croxteth Way, Wantirna, Vic. 3152
877	06-May-58	06-May-58	Dawson, John Acton	10 Fox Road, Narre Warren North Vic. 3804
1658	20-Jun-89	20-Jun-89	De Marco, Ronald Anthony	10/5 Selwyn Court, Toorak, Vic, 3142
1133	06-Jun-68	06-Jun-68	De Vries, Allan Ronald	107/67 Maroondah Highway, Croydon, Vic. 3136
939	16-Dec-60	16-Dec-60	Dea, James Andrew	47 Princes Hwy, Dandenong, Vic. 3175
1821	23-Oct-02	23-Oct-02	Degg, Michael Neylan	39 Ramsay Street, Essendon, Vic. 3040
1281	03-Oct-74	03-Oct-74	Dell, Peter G.	13 Blundell Court, Traralgon, Vic. 3844
1823	23-Oct-02	23-Oct-02	Dennis, Peter Andrew	685 Glenhuntly Road, Caulfield South Vic. 3162
1207	16-Nov-71	16-Nov-71	Densten, Malcolm Gardner	4/5 Potts Street, Mentone, Vic. 3194
599	12-Oct-31	12-Oct-31	Denton, John Bengrey	Address unknown
1530	04-May-82	04-May-82	Derham, Terence Michael	4 Leischa Court, Greensborough, Vic. 3088
1826	18-Dec-02	18-Dec-02	Desmond, Matthew Gerard	75 Daisy Hill Road, Doreen, Vic. 3754
1742	17-Aug-95	17-Aug-95	Dewing, Brian	24 Ray Road, Epping, NSW 2121

1439	23-Nov-78	23-Nov-78	Di Mase, Carmine	PO Box 168, Brunswick, Vic. 3056
789	12-Oct-53	12-Oct-53	Dickins, Charles McNeil	6 Hartley Court, Mount Gambier, SA 5290
1612	21-Oct-86	21-Oct-86	Dickson, Russell John	685 Glenhuntly Road, South Caulfield, Vic. 3162
1567	10-May-84	10-May-84	Dilley, Andrew William	23 Heath Road, Belgrave South, Vic. 3160
655	06-Nov-41	06-Nov-41	Dillon, Eoin Thomas More	PO Box 122, Essendon, Vic. 3040
895	01-May-59	01-May-59	Dimmick, John McLaren	20 Kennon Street, East Doncaster, Vic. 3109
1657	16-May-89	16-May-89	Dingeldei, Phillip Wayne	Level 3, 47 Princess Highway, Dandenong, Vic. 3175
886	27-Oct-58	27-Oct-58	Donovan, John	3 Reserve Avenue, Carnegie, Vic. 3163
1617	19-Feb-87	19-Feb-87	Dooley, Phillip Joseph	10 Sixth Avenue, Anglesea, Vic. 3230
1620	28-Apr-87	28-Apr-87	Dore, Mark Gregory	“Prinprinyah”, Mahoneys Lane, Dunkeld, Vic 3294
1239	01-Nov-72	01-Nov-72	Douglas, Scot	PO Box 83, Stawell, Vic. 3380
1028	09-Dec-64	09-Dec-64	Dowell, Herbert R.	Address unknown
1160	24-Jun-69	24-Jun-69	Dowling, David Graeme	PO Box 17, Darling Heights, Qld 4350
851	21-May-57	21-May-57	Downes, Rex Charlton	33 Hawke Street, Parkdale, Vic. 3195
1209	29-Nov-71	29-Nov-71	Duff, Barry Stewart	56 Ruskin Street, Elwood, Vic. 3184
1447	28-Jun-79	28-Jun-79	Dunkley, Colin Bruce	28 Gray Street, Hamilton, Vic. 3300
1629	13-Oct-87	13-Oct-87	Dunn, Raymond James	50 Western Beach, Geelong, Vic. 3220
922	27-Jun-60	27-Jun-60	Dwyer, John L.	GPO Box 5175AA, Melbourne, Vic. 3001
1796	19-Jun-01	19-Jun-01	Dwyer, Paul Anthony	15 Riverbank Road, Bairnsdale East, Vic. 3875
1276	25-Jul-74	25-Jul-74	Dymond, Harley Edward	4 Howell Street, Marmion, WA 6020
1737	20-Jun-95	20-Jun-95	Earls, Raymund Francis	37 Derby Crescent, Caulfield East, Vic. 3145
1082	15-Jul-66	15-Jul-66	Eccleston, Gregory Compton	37 Evandale Road, Malvern, Vic. 3144
1127	13-Nov-67	13-Nov-67	Eddington, Robert Arthur	39 Headingley Road, Mount Waverley, Vic. 3149

779	23-Dec-52	23-Dec-52	Edwards, Frederick Hay	8 Mildura Avenue, Sandringham, Vic. 3191
1293	12-Dec-74	12-Dec-74	Edwards, Graeme John	21 Coolstore Road, Croydon, Vic. 3136
924	27-Jun-60	27-Jun-60	Edwards, John Raymond Keith	59 Fletcher Street, Essendon, Vic. 3040
1333	11-Dec-75	11-Dec-75	Egan, Christopher John	73 Rose Street, Brnswick, Vic. 3056
1445	24-May-79	24-May-79	Egan, John Francis	PO Box 17, Bonnie Doon, Vic. 3720
607	22-Mar-32	22-Mar-32	Egan, William Rogers	Address unknown
984	26-Jun-63	26-Jun-63	Ekins, Max Godfrey Grindon	150 Weekes Road, Moggill, Qld 4070
1061	09-Dec-65	09-Dec-65	Ellis, David	5 Florida Avenue, Dingley, Vic. 3172
948	31-May-61	31-May-61	Ellis, Peter	7 Cootha Street, Everton Park, Qld 4053
630	06-Apr-36	06-Apr-36	Elms, Leslie W.P	Address unknown
1541	18-Nov-82	18-Nov-82	Emmerson, Timothy J.	6 Hubert Street, Upwey, Vic. 3158
1229	17-Jul-72	17-Jul-72	Erickson, Terence Eric	PO Box 1419, Palmerston, NT 831
1579	15-Nov-84	15-Nov-84	Esler, Patrick Francis	598 Macauley Street, Albury, NSW 2640
1282	03-Oct-74	03-Oct-74	Eustice, George Lyndon	5 Moss Court, Croydon, Vic. 3136
885	23-Oct-58	23-Oct-58	Ewart, Lindsay Keith	3/9 Codrington Street, Dromana, Vic. 3936
787	10-Jun-53	10-Jun-53	Fallow, Ronald Fife	38 Wilsons Road, Mornington, Vic. 3931
1426	04-Oct-78	04-Oct-78	Falloon, Robert Charles	152-2-4 Villa Flora, Condomin TTDI, Kuala Lumpur 60000, Malaysia
1453	18-Oct-79	18-Oct-79	Falzon, Stephen Joseph	10 Ardcloney Drive, Sunbury, Vic. 3429
1508	07-May-81	07-May-81	Fanshaw, Francis John	26 Paxton Drive, Glen Waverley, Vic. 3150
989	28-Jun-63	28-Jun-63	Farley, John A.	Address unknown
1637	16-Feb-88	16-Feb-88	Farnsworth, Neil William	57 Moss Street, East Fremantle, WA 6158
644	25-Sep-39	25-Sep-39	Farran, Douglas C.	Address unknown
1760	17-Mar-98	17-Mar-98	Farren, Peter John	15 Studley Street, Maidstone, Vic. 3012
679	01-Nov-46	01-Nov-46	Faulks, George Edward	Address unknown

873	02-May-58	02-May-58	Fayers, Michael John	3 Glenny Lane, Numurkah, Vic 3636
1800	18-Sep-01	18-Sep-01	Fazackerley, Alan	13/25 Malmsbury Street, Hawthorn, Vic. 3122
1396	20-Oct-77	20-Oct-77	Feddersen, Geoffrey Stuart	5/61 Smith Street, Warragul, Vic. 3820
951	09-Jun-61	09-Jun-61	Feltham, Kevin Leon	PO Box 61, Port Albert, Vic. 3971
1050	06-Dec-65	06-Dec-65	Fennell, Alan James	352 Grimshaw Street, Watsonia, Vic. 3087
1078	13-Jul-66	13-Jul-66	Ferguson, Noel James	62 McLachlan Street, Horsham, Vic. 3400
1245	07-Mar-73	07-Mar-73	Fetterplace, David	18 Reed Street, Albert Park, Vic. 3206
1341	22-Jan-76	22-Jan-76	Fisher, Gary Ian	198A Brisbane Street, Launceston, Tas. 7250
846	31-Jan-57	31-Jan-57	Fisher, John David	PO Box 40, Tallangatta, Vic. 3700
892	28-Apr-59	28-Apr-59	Flintoff, Alexander Vincent	PO Box 334, Warragul, Vic. 3820
1248	06-Sep-73	06-Sep-73	Flynn, Kevin Bernard	314 Somerville Street, Buninyong, Vic. 3357
1493	20-Nov-80	20-Nov-80	Follett, Graeme Leonard	PO Box 721, Shepparton, Vic. 3632
1564	17-Apr-84	17-Apr-84	Foote, Richard Vicars	4 Formby Close, Wantirna, Vic. 3152
1824	13-Nov-02	13-Nov-02	Ford, Darren Kevin	138 Twelfth Street, Mildura, Vic. 3500
979	23-Nov-62	23-Nov-62	Ford, Donald B.	32 Porter Street, Templestowe Vic. 3106
1320	10-Jul-75	10-Jul-75	Ford, John Charles	22 Luton Way, Bundoora, Vic. 3083
1469	20-Nov-80	20-Nov-80	Ford, Robert J. C.	72 Maluka Street, Bellerive, Tas. 7018
1211	03-Dec-71	03-Dec-71	Fordyce, Thomas	8 Valda Grove, Brighton, Vic. 3186
1542	18-Nov-82	18-Nov-82	Forge, Trevor Neill	80 22nd Avenue, Eden Park, Vic. 3757
1130	27-Nov-67	27-Nov-67	Forster, Bruce C.	30 Glebe Street, Randwick, NSW 2031
1198	14-Jul-71	14-Jul-71	Forster, David Croft	PO Box 653, Cooktown, Qld 4871
1792	10-Apr-01	10-Apr-01	Forster, Geoffrey Ian	19 Hopkins Road, Warrnambool, Vic. 3280
1496	21-Aug-80	21-Aug-80	Foster, Gregory Fraser	16 Sewell Street, East Fremantle, WA 6158
883	22-Oct-58	22-Oct-58	Franks, Kenneth George	197A Springfield Road, Blackburn, Vic. 3130

1705	18-Nov-92	18-Nov-92	Fransen, Charles	594 Heathwood Avenue, Lavington, NSW 2641
1395	15-Sep-77	15-Sep-77	Fraser, Alan P.	RMB 6780, Maffra, Vic. 3680
1765	16-Jun-98		Fraser, Clive S.	72 Mont Albert Road, Canterbury, Vic. 3126
972	27-Jun-62	27-Jun-62	Fraser, Douglas Bruce	107 Finlay Road, Thurgoona Park, NSW 2640
1219	05-May-72	05-May-72	Frater, John William	20 St Johns Wood Road, Mount Waverley, Vic. 3149
11748	21-Jun-96	21-Jun-96	Freeman, Bradley David Bruce	PO Box 480, Bairnsdale, Vic. 3875
1692	09-Dec-91	09-Dec-91	Freeman, Robert Bruce	130 Langtree Avenue, Mildura, Vic. 3500
553	23-Jun-83	23-Jun-83	Freeman, Thomas George	24 Wallis Avenue, East Ivanhoe, Vic. 3079
1060	09-Dec-65	09-Dec-65	Freund, Kevin Aug	PO Box 6, Mawson, ACT 2607
1402	10-Nov-77	10-Nov-77	Fry, Graham John	6 Aton Street, Warrandyte, Vic. 3113
640	04-Oct-37	04-Oct-37	Fryer, Clarence N.	PO Box 1, Broadbeach Junction, Qld 4217
1220	19-May-72	19-May-72	Gadsby, Terrance Leonard	110 Memorial Avenue, Alice Springs, NT 870
1593	19-Dec-85	19-Dec-85	Gallagher, John B.	58 Clanwilliam Street, Eastwood, NSW 2122
1454	18-Oct-79	18-Oct-79	Gallagher, John Bernard	9 Lyon Street, Essendon, Vic.3040
903	03-Sep-59	03-Sep-59	Gallagher, Leo Daniel	23 Scott Avenue, Leura, NSW 2780
1381	21-Apr-77	21-Apr-77	Gambell, John Alexander	6 Narracan Street, Vermont South, Vic. 3133
960	24-Nov-61	24-Nov-61	Gamble, Roger Martin	28 Summit Crescent, Ringwood, Vic. 3134
813	19-Nov-54	19-Nov-54	Gannon, John Andrew	7/21 Wallace Avenue, Toorak, Vic. 3142
1088	24-Aug-66	24-Aug-66	Gardner, Rossley Paul	85 Bouchiers Road, Kangaroo Ground, Vic. 3097
954	14-Jun-61	14-Jun-61	Garlick, Lewis Don	36 Fiander Avenue, Glen Waverley, Vic. 3150
786	15-Jun-53	15-Jun-53	Garner, Frank D.	Address unknown
634	05-Oct-36	05-Oct-36	Garner, Jack Hume	13 Garden Street, Hampton, Vic. 3188

1647	25-Oct-88	25-Oct-88	Garton, Richard William	27 Miller Street, Highett, Vic. 3190
1621	28-Apr-87	28-Apr-87	Gellert, Charles David	Box 4, Kerrimuir, Vic. 3129
1804	19-Feb-02	19-Feb-02	George, Timothy David	5 Tarwin Drive, Croydon Hills, Vic. 3136
1761	17-Mar-98		Gerdan, George Paul	19 Sirius Place, Narre Warren South, Vic. 3805
1551	19-Mar-83	19-Mar-83	Gibson, Allen George	13 Douglas Street, Beaumaris, Vic. 3193
1695	09-Dec-91	09-Dec-91	Gibson, Barrie Denhame	117 Dalgetty Road, Beaumaris, Vic. 3193
956	10-Jun-61	10-Jun-61	Gibson, Gordon J. C.	4 Waverley Terrace, Hove, SA 5048
1697	29-Apr-92	29-Apr-92	Gilbert, Graeme Stuart	113 Telford Drive, Berwick, Vic. 3806
1774	14-Dec-99	14-Dec-99	Gill, Rodney Graeme	8 Derna Road, Ashburton, Vic. 3147
1168	01-Sep-69	01-Sep-69	Ginn, John Norton	PO Box 75 Manurewa, Auckland New Zealand
852	27-May-57	27-May-57	Gissing, Kevin Anthony	3 Harwood Street, Brighton Vic. 3186
1111	13-Jun-67	13-Jun-67	Gleeson, Brian Thomas	42 Victoria Street, Fitzroy, Vic. 3065
1734	26-Apr-95	26-Apr-95	Gleeson, James Patrick	33 The Boulevard, Hawthorn, Vic. 3122
1494	20-Nov-80	20-Nov-80	Gleeson, Thomas James	21 Pepperdine Way, Highton Vic. 3216
1302	26-Feb-75	26-Feb-75	Goode, Michael	8 Upper Skene Street, Newtown, Vic. 3220
1829	18-Feb-03	18-Feb-03	Goodison, Bernard Francis	305 Bridge Road, Richmond, Vic. 3121
1203	23-Aug-71	23-Aug-71	Goodison, Kenneth John	305 Bridge Road, Richmond, Vic. 3121
1044	01-Jul-65	01-Jul-65	Goss, Alan	17 Ardoyne Street, Black Rock, Vic. 3193
1592	15-Oct-85	15-Oct-85	Gow, Douglas James	609 Olive Street, Albury, NSW 2640
905	13-Nov-59	13-Nov-59	Grace, Roderick John	142 Lawrence Road, Mount Waverley, Vic. 3149
1223	19-Jun-72	19-Jun-72	Grant, Alan Gerard	14 Anderson Avenue, Ashgrove, Qld 4060
978	07-Sep-62	07-Sep-62	Grant, Donald Morrison	52 Freestone Way, Bathurst NSW 2795

1775	14-Dec-99	14-Dec-99	Gray, Cameron John	40 Little Charles Street, Fitzroy, Vic. 3065
1263	21-Mar-74	21-Mar-74	Gray, Peter James	PO Box 328, Palmerston, NT 831
849	11-Apr-57	11-Apr-57	Gray, Richard Lewis	18 Chapel Road, Moorabbin, Vic. 3189
1475	22-May-80	22-May-80	Green, Barry S.	75 Victoria Road, Hawthorn East, Vic. 3123
899	15-May-59	15-May-59	Green, John R.	Address unknown
1754	18-Mar-97	18-Mar-97	Green, Laurence Rohan	1/100 Moore Street, Trinity Beach, Qld 4879
1662	21-Nov-89	21-Nov-89	Green, Roger Philip	Level 3, 47 Princess Highway, Dandenong, Vic. 3175
1382	21-Apr-77	21-Apr-77	Grenfell, Ronald Ian	70 Major Crescent, Lysterfield, Vic. 3156
1199	14-Jul-71	14-Jul-71	Grey, Peter George	PO Box 169, Glen Iris, Vic. 3146
1290	07-Nov-74	07-Nov-74	Griffin, Robert Woodbrook	C/- Titoki PDC, Pvt Bag Whangarei 250 New Zealand
783	05-Jun-53	05-Jun-53	Griffiths, George Edgar	3/1217 Burke Road, Kew, Vic. 3101
1715	16-Feb-94	16-Feb-94	Grubb, Jeffrey Alan	10 Dowding Street, California Gully, Vic. 3556
1106	27-Jun-67	27-Jun-67	Guiver, George Nicholas	1 Erin Court, Doncaster, Vic. 3108
741	16-Oct-50	16-Oct-50	Gulbin, Stewart	266 Greenhills Road, Bundoora, Vic. 3083
1242	02-Feb-73	02-Feb-73	Haddon, Keith John	PO Box 880, Bathurst, NSW 2795
1726	26-Oct-94	26-Oct-94	Hailes, Grant Michael	PO Box 161, Leongatha, Vic. 3935
945	08-Jan-61	08-Jan-61	Haine, David	25 Hawdon Street, Broadford, Vic. 3658
1409	13-Apr-78	13-Apr-78	Hale, Martin John	PO Box 500, East Melbourne, Vic. 3002
1295	16-Jan-75	16-Jan-75	Hales, James Joseph	38 Thompson Street, Warrnambool, Vic. 3280
999	05-Dec-63	05-Dec-63	Halford, David Riviere	36 Boardman Close, Box Hill South, Vic. 3128
1785	07-Jul-00	07-Jul-00	Hall, Colin James	23 Glanfield Street, Northcote, Vic. 3070
1217	02-May-72	02-May-72	Hall, Ian Richard	4 Grovedale Road, Surrey Hills, Vic. 3127

1724	26-Oct-94	26-Oct-94	Hallyburton, Peter Andrew	28 Wilfred Road, Ivanhoe, Vic. 3079
880	25-Jul-58	25-Jul-58	Hamm, George Francis	1 Snow Court, Bacchus Marsh, Vic. 3340
1271	23-May-74	23-May-74	Hand, Michael William	23 Walter Crescent, Warrnambool, Vic. 3280
623	08-Apr-35	08-Apr-35	Hanley, John D.	5 Kiora Street, Essendon, Vic. 3040
1397	20-Oct-77	20-Oct-77	Hann, David Charles	33 Walker Road, Wonga Park, Vic. 3115
1208	05-Nov-71	05-Nov-71	Hansen, Kai	PO Box 32, Berwick, Vic. 3806
1436	29-May-78	29-May-78	Hansen, Peter Clyde	3 Norfolk Avenue, Ringwood, Vic. 3134
1043	24-Mar-65	24-Mar-65	Hardiman, Peter John	2/358 Lower Plenty Road, Rosanna, Vic. 3084
1603	13-May-86	13-May-86	Harland, Brian James	PO Box 586, Echuca, Vic. 3564
1654	18-Apr-89	18-Apr-89	Harman, Andrew Stuart	5 Dawson Street South, Ballarat, Vic. 3350
782	05-Jun-53	05-Jun-53	Harris, Geoffrey Arthur	8 Theresa Street, Bentleigh, Vic. 3204
1264	21-Mar-74	21-Mar-74	Harris, James A.	PO Box 5585, Bundall, Qld 4717
1071	13-May-66	13-May-66	Harris, John M.	7 Leonore Close, Renyella, SA 5161
1190	16-Mar-71	16-Mar-71	Harris, Peter Leslie	PO Box 56, Manunda, Qld 4870
1066	17-Dec-65	17-Dec-65	Harrison, David Calder	32 Maud Street, Balwyn North, Vic. 3104
993	21-Jun-63	21-Jun-63	Harrison, Michael Edward	9 Anstey Street, Albion, Qld 4010
1768	16-Feb-99	16-Feb-99	Hart, Anthony P.	"Bonnie Doon", Bruxner Highway, Alstonville, NSW 2477
798	26-Apr-54	26-Apr-54	Harte, Raymond Francis	90 Dare Street, Ocean Grove, Vic. 3226
1495	20-Nov-80	20-Nov-80	Hassett, David Laurence	20 Lees Street, McKinnon, Vic. 3204
1763	17-Mar-98	17-Mar-98	Hatch, Robert Tracey	19 Hutton Street, Thornbury, Vic. 3071
1582	18-Apr-85	18-Apr-85	Havelberg, Geoffrey Keith	12 Burchill Court, Leopold, Vic. 3224
1555	20-Oct-83	20-Oct-83	Havill, Robert John	71 Blackstone Street, Indooroopilly, Qld 4068
1176	05-Jun-70	05-Jun-70	Hayes, Peter John	PO Box 454 Wollongong East, NSW 2520

1585	23-Apr-85	23-Apr-85	Hazelton, Nicholas William Joseph	461 Lambourne Avenue, Worthington, Ohio 43085-2440, USA
1685	14-Aug-91	14-Aug-91	Head, Walter John	PO Box 3121, Weston, ACT 2611
1151	30-Jan-69	30-Jan-69	Heintke, Christian Karl	RMB 2740 Factory Road, Milawa, Vic. 3678
827	25-Nov-55	25-Nov-55	Hellier, Russell	411 Beach Road, Beaumaris, Vic. 3193
1543	18-Nov-82	18-Nov-82	Henderson, David Colin	610 Burwood Road, Hawthorn, Vic. 3122
1172	04-Feb-70	04-Feb-70	Herbert, Peter Francis	13 Union Street, North Melbourne, Vic. 3051
677	08-Oct-46	08-Oct-46	Heron, Clarence Andrew	PO Box 118, Traralgon, Vic. 3844
689	24-Apr-47	24-Apr-47	Heron, Leonard Charles	180 Anderson Road, Barrabool, Vic. 3221
1283	03-Oct-74	03-Oct-74	Hewett, Gregory John	16 Amiens Street, Hampton, Vic. 3188
950	07-Jun-61	07-Jun-61	Heyworth, Xavier Jose Johnstone	8 Greenbank Avenue, Box Hill South, Vic. 3128
1313	13-Mar-75	13-Mar-75	Hickey, John Dennis	520 Murray Crescent, Albury, NSW 2640
1639	19-Apr-88	19-Apr-88	Higbid, Shaun R.	28 Latham Street, Alfred Cove, WA 6154
974	26-Jun-62	26-Jun-62	Higgins, John T.	4 Macquarie Place, Denistone East, NSW 2112
816	19-Nov-54	19-Nov-54	Hill, Bryan Geoffrey	48 Bayview Road, Balnarring Beach, Vic. 3926
977	15-Jun-62	15-Jun-62	Hillan, David Nathan	8 Settlers Court, Paralowie, SA 5108
1169	24-Oct-69	24-Oct-69	Hilton, Peter William	11 Forest Court, Templestowe, Vic. 3106
1740	20-Jun-95	20-Jun-95	Hipfel, Michael Herwald	14 Maroondah Highway, Healesville, Vic. 3777
1225	19-Jun-72	19-Jun-72	Ho, Kim Swee	#07-02 5 Pereira Road 368025, Singapore
1123	10-Nov-67	10-Nov-67	Ho, Tony	11 Raymond Road, Rowville, Vic. 3178
1076	04-Jul-66	04-Jul-66	Hoadley, Jack Archibald	2/15 Hill Street, Hawthorn, Vic. 3122
1158	17-Jun-69	17-Jun-69	Hoban, Anthony John	5 Silkhorn Crescent, Mount Mattha, Vic. 3934
1798	17-Jul-01	17-Jul-01	Hockley, Richard David	4 Karumba Court, Leopold, Vic. 3224

765	17-Apr-52	17-Apr-52	Hogan, Kieran Michael	18 Quest Road, South Oakleigh, Vic. 3167
1360	11-Nov-76	11-Nov-76	Hoggard, Gerald Anthony	799 Springvale Road, Mulgrave, Vic. 3170
1575	15-Nov-84	15-Nov-84	Hoinville, Gregory J.	3 Gladys Grove, Croydon, Vic. 3136
731	18-Oct-49	18-Oct-49	Holmes, Raymond Eden	PO Box 221, Toorak, Vic. 3142
1216	22-Mar-72	22-Mar-72	Holmes, Graham	Unit B, 81 Beach Road, Matua, Tauranga 3001, New Zealand
1153	14-Feb-69	14-Feb-69	Homann, Barry Anthony	320 Scenic Highway, Terrigal, NSW 2260
844	13-Dec-56	13-Dec-56	Hopkins, Richard Walter	RA635 Nubeena Road, Koonya, Tas. 7187
867	14-Nov-57	14-Nov-57	Horne, John M.	7 Reid Street, Frankston, Vic. 3199
695	30-Sep-47	30-Sep-47	Houghton, Aubrey Russell	1157-9 Heatherton Road, Noble Park, Vic. 3174
1279	12-Sep-74	12-Sep-74	Houghton, Elliott Leslie	PO Box 7355, Urangun, Qld 4655
1410	13-Apr-78	13-Apr-78	Hucker, Gary Raymond	38 Haymes Road, Mount Clear, Vic. 3350
871	11-Mar-58	11-Mar-58	Hudson, Ian Cottrell	40 Norman Crescent, Point Lonsdale, Vic. 3225
1411	13-Apr-78	13-Apr-78	Humphrey, Geoffrey Warwick	25A Oliver Road, Templestowe, Vic. 3106
1100	27-Jun-67	27-Jun-67	Humphreys, John Willis	31 Highview Grove, Burwood East, Vic. 3151
890	11-Mar-59	11-Mar-59	Humphreys, Vincent James	PO Box 92, Cootamundra, NSW 2590
1069	28-Mar-66	28-Mar-66	Hunt, Brian Atlee	69 Great Northern Hway, Midland, WA 6056
968	15-Jun-62	15-Jun-62	Hunter, Cecil Ross	PO Box 50, MT 4871
1573	17-Oct-84	17-Oct-84	Hunter, Gary John	147 Railway Parade Seaford, Vic. 3198
1272	23-May-74	23-May-74	Hunter, John	Address unknown
1131	04-Dec-67	04-Dec-67	Hutchinson, John Barry	PO Box 230, Clifton Hill, Vic. 3068
1576	15-Nov-84	15-Nov-84	Illingworth, Graeme Harold	23 Heatherbrae Avenue, Caulfield, Vic. 3162
1137	14-Aug-68	14-Aug-68	Imberger, Dieter Gerhard	3/25 Cuthbert Street, Heathmont, Vic. 3135
1194	02-Apr-71	02-Apr-71	Ingram, William Warwick	6 Hawkins Street, Mt Pleasant, WA 6153
1517	20-Oct-81	20-Oct-81	Innes, Geoffrey Paul	48 Marine Terrace, Geraldton, WA 6530

1446	24-May-79	24-May-79	Ireson, Ian John	570 Bourke Street, Melbourne, Vic. 3000
750	16-Apr-51	16-Apr-51	Jackson, James C. B.	Address unknown
1255	13-Dec-73	13-Dec-73	Jackson, John	97 Tyers Street, Stratford, Vic. 3862
1292	12-Dec-74	12-Dec-74	Jackson, Raymond Leslie	7 Janson Road, Brown Hill, Vic. 3350
1455	18-Oct-79	18-Oct-79	Jackson, Russell J.	8 Kalinya Drive, Wantirna, Vic. 3152
944	19-Jan-61	19-Jan-61	James, Earl Bruester McDonald	16 Allen Street, Fannie Bay, NT 820
1561	27-Oct-83	27-Oct-83	Jarman, Anthony Robin	PO Box 259, Bega, NSW 2550
1427	04-Oct-78	04-Oct-78	Jeavons, Anthony Harold	PO Box 196, Apollo Bay, Vic. 3233
928	04-Jul-60	04-Jul-60	Jefferson, Noel K.	RMB 7410 Wangaratta, Vic. 3678
943	12-Jan-61	12-Jan-61	Jeffreys, Arthur Albert	14 Regency Drive, Mount Clear, Vic. 3350
1377	10-Mar-77	10-Mar-77	Jeffreys, Stanley George	PO Box 5628, Cranbourne, Vic. 3977
1420	11-May-78	11-May-78	Jeffer, Ernest John	11 Heritage Drive, Springvale, Vic. 3171
1236	04-Aug-72	04-Aug-72	Jennings, Wayne Alan	PO Box 5744, West End, Qld 4101
934	14-Oct-60	14-Oct-60	Johns, Warren T.	49 The Esplanade, Balmoral Beach, NSW 2088
1124	10-Nov-67	10-Nov-67	Johnson, Alan Leslie	28 Scott Street, Wangaratta, Vic. 3677
1314	13-Mar-75	13-Mar-75	Johnston, Frank Leslie	4 Webb Place, Doncaster East, Vic. 3109
1226	23-Jun-72	23-Jun-72	Johnston, Robert A.	Lomond Way, Launching Place, Vic. 3139
1080	14-Jul-66	14-Jul-66	Johnstone, Michael F.	236 Coolart Road, Somerville, Vic. 3912
1113	06-Jul-67	06-Jul-67	Jolley, Peter E.	Address unknown
805	30-Apr-54	30-Apr-54	Jones, Irvine J.	381 Stephenson's Road, Mount Waverley, Vic. 3149
648	22-Apr-40	22-Apr-40	Jones, Clem	758 Old Cleveland Road, Camp Hill, Qld 4152
1443	26-Apr-79	26-Apr-79	Jones, Colin John	Lot 4, Carolyn Court, Callignee, Vic. 3844

1241	09-Nov-72	09-Nov-72	Jones, Ian Alexander	26 Pinehills Drive, Greensborough, Vic. 3088
1212	06-Mar-72	06-Mar-72	Jones, John Alwyn	6 Mersey Place, Avondale 1007, New Zealand
935	14-Oct-60	14-Oct-60	Jones, Kent Granville	10 Cooke Way, Epping, NSW 2121
1456	18-Oct-79	18-Oct-79	Jones, Keith Robert	4/91 Ringwood Street, Ringwood, Vic. 3134
1303	26-Feb-75	26-Feb-75	Jones, Mervyn John	51 Winona Road, Mount Eliza, Vic. 3930
1677	16-May-90	16-May-90	Jones, Michael Glen	18 Breed Street, Traralgon Vic. 3844
775	14-Nov-52	14-Nov-52	Jones, Robert Alexander	Address unknown
1270	02-May-74	02-May-74	Jonson, Robert Norman	71 Palmerston Crescent, South Melbourne, Vic. 3205
1565	17-Apr-84	17-Apr-84	Jubb, Rowland Davidson	11 Tasman Avenue, Upwey, Vic. 3158
1828	18-Feb-03	18-Feb-03	Jukes, Scott David	15/570 Bourke Street, Melbourne, Vic. 3000
806	05-May-54	05-May-54	Julian, Roger Crewe	PO Box 166, Surrey Hills, Vic. 3127
1308	28-Feb-75	28-Feb-75	Kalkman, Marcus John	PO Box 63, Rosebud, Vic. 3939
1744	06-Sep-95	06-Sep-95	Keable, Raymond Mervyn	60 School Road, Yeronga, Qld 4104
1635	17-Dec-87	17-Dec-87	Kean, John Joseph	53 Lincoln Street, Largs Bay, SA 5016
1304	26-Feb-75	26-Feb-75	Kearney, Denis John	53 Rose Street, Essendon, Vic. 3040
981	07-Feb-63	07-Feb-63	Keays, Frank Alexander	41 Regency Drive, Thornlie, WA 6108
1121	11-Aug-67	11-Aug-67	Keegan, Bryan P.	Address unknown
1671	24-Jan-90	24-Jan-90	Keen, Jonathan Charles	PO Box 257, Cronulla, NSW 2230
1404	10-Nov-77	10-Nov-77	Keith, Ian Gordon	1 Canfield Crescent, Traralgon, Vic. 3844
982	22-Apr-63	22-Apr-63	Kellock, Michael David	PO Box 100, Foster, Vic. 3960
1537	19-Aug-82	19-Aug-82	Kelly, Ian Edmund	105 Gregory Street, Geraldton, WA 6530
1701	27-Oct-92	27-Oct-92	Kelly, Trevor John	84 Tennyson Street, Essendon, Vic. 3040
1656	02-May-89	02-May-89	Kemp, Alastair D.	RMB 4370, Glenrowan, Vic. 3675

1259	21-Mar-74	21-Mar-74	Kemp, John William	11 Karanne Drive, Mooloolah, Qld 4553
1755	22-Oct-51	22-Oct-51	Kennedy, James McKenzie	37 Love Street, Black Rock, Vic. 3193
796	07-Dec-53	07-Dec-53	Kennedy, John Brian Michael	1 Hodgson Place, Pearce, ACT 2607
407	09-Feb-78	09-Feb-78	Kennedy, Paul Mathias	10 Bindowan Drive, Hoppers Crossing, Vic. 3029
1357	16-Sep-76	16-Sep-76	Kenny, Paul Francis	PO Box 112, Benalla, Vic. 3672
1344	08-Apr-76	08-Apr-76	Kent, Brian	5/1150 Pittwater Road, Collaroy Beach, NSW 2097
1738	20-Jun-95	20-Jun-95	Kenter, John Peter	14 Hamilton Grove, Frankston Vic. 3199
940	19-Dec-60	19-Dec-60	Key, Bruce George	20 Lavender Street, Wodonga, Vic. 3690
980	28-Nov-62	28-Nov-62	Killey, Leonard James	4 Morrison Crescent, Doncaster, Vic. 3108
1221	25-May-72	25-May-72	Kinsey, Raymond Harold	232 High Street, Kangaroo Flat, Vic. 3555
863	08-Nov-57	08-Nov-57	Kirkpatrick, Donald Ian	52 Grey Street, Ringwood East, Vic. 3135
1361	11-Nov-76	11-Nov-76	Kirley, Gary	42 Albert Street, Williamstown, Vic. 3016
1053	09-Dec-65	09-Dec-65	Kluge, Hans Peter	5 Rosita Court, Sale, Vic. 3850
1722	21-Sep-94	21-Sep-94	Knight, Craig John	Boree Grange, Jerilderie, NSW 2716
1030	22-Dec-64	22-Dec-64	Knight, Gavin E.	310 Eacotts Road, Hoddles Creek, Vic. 3139
1086	26-Jul-66	26-Jul-66	Knuckey, Ronald Gordon	Dapplestone, 1A The Green, Martock, Somerset TA12, 6NE
1233	27-Jul-72	27-Jul-72	Komora, Stan	2 Combermere Street, Essendon, Vic. 3040
1197	13-Jul-71	13-Jul-71	Konings, John David	13 Searle Horsham, Vic. 3400
893	01-May-59	01-May-59	Konzag, Harold Noel	1/27 Thomson Street, Essendon, Vic. 3040
738	28-Apr-50	28-Apr-50	Kosky, Keith William	20 Eckersall Street, Brunswick, Vic. 3056
1558	27-Oct-83	27-Oct-83	Ladner, Graeme E.	7 Calbourne Street, Preston, Vic. 3072
1830	19-Mar-03	19-Mar-03	Ladner, Geoffrey John	8-12 Sandilands Street, South Melbourne, Vic. 3205

970 G 19 8 May 2003

Victoria Government Gazette

918	02-May-60	02-May-60	Lambden, David W.	University of Toronto, Mississauga, Ontario, Canada
1599	13-May-86	13-May-86	Langenbacher, Mark Francis	PO Box 586, Echuca, Vic. 3564
1065	29-Dec-65	29-Dec-65	Langhorne, Peter Handley	3 Simmie Place, Wanniassa, ACT 2903
983	21-Jun-63	21-Jun-63	Larmer, Michael James	37 The Esplanade, Balmoral, NSW 2088
1533	20-May-82	20-May-82	Larsen, Stephen Christopher	Unit 1, 19 Binnalong Ave, Chadstone, Vic. 3148
1544	18-Nov-82	18-Nov-82	Laughlin, David Chester	PO Box 88, Barham, NSW 2732
1634	08-Oct-87	08-Oct-87	Lawford, Geoffrey John	126 Burrinjuck Crescent, Duffy, ACT 2611
1070	30-Mar-66	30-Mar-66	Lawler, Gerald A.	PO Box 349, Mooloolaba, Qld 4557
1093	29-Dec-66	29-Dec-66	Lawlor, Kevin Anthony	7/27 Hinkler Crescent, Fannie Bay, NT 820
746	08-Dec-50	08-Dec-50	Lawry, Rex	76 Kitchener Street, Broadmeadows, Vic. 3047
957	14-Aug-61	14-Aug-61	Leahy, Francis J.	15 Bengal Crescent, Mount Waverley, Vic. 3149
1309	28-Feb-75	28-Feb-75	Leared, John R.	85 Ruskin Street, Elwood, Vic. 3184
1684	17-Jul-91	17-Jul-91	Learmont, Murray D.	“Yallakool”, Monaro Hwy, Cooma, NSW 2630
1383	21-Apr-77	21-Apr-77	Lebon, Alex G.	13 Short Road, Riverwood, NSW 2210
1144	08-Nov-68	08-Nov-68	Leditschke, Ralph Colin	41 Tullimbar Circuit, Vermont South, Vic. 3133
804	29-Apr-54	29-Apr-54	Lee, Ronald	26 Church Street, Vic.
771	14-Nov-52	14-Nov-52	Legge-Wilkinson, Leonard Paul	37 Scott Street, Narrabundah, ACT 2604
1708	18-Jun-93	18-Jun-93	Legun, Bogdan	12 Chandler Grove, Burwood, Vic. 3125
887	05-Dec-58	05-Dec-58	Leitch, Kenneth	11 Gabon Street, Stafford, Qld 4053
1672	24-Apr-90	24-Apr-90	Leong, Peter Peng Chiew	16 Jalan Gambut, Kuantan, Pahang 25000, Malaysia
722	03-Nov-48	03-Nov-48	Lester, Charles E.	41 Foam Street, Rosebud, Vic. 3939
1428	04-Oct-78	04-Oct-78	Lester, Christopher John	122 Mooltan Street, Ascot Vale, Vic. 3032

896	01-May-59	01-May-59	Lewin, John Nutter	23 Parkin Street, Glen Iris, Vic. 3146
1356	20-Aug-76	20-Aug-76	Lewington, Louis A.	Churchill Street, Uranquinty, NSW 2650
1710	20-Sep-93	20-Sep-93	Lewis, Bruce	18 McGregor Street, Middlepark, Vic. 3056
1405	10-Nov-77	10-Nov-77	Lidbury, Brian Albert	3 Wharf Street, Forster, NSW 2428
1371	16-Dec-76	16-Dec-76	Liew, Yaw K.	G.P.O. Box 1680 Darwin, NT 801
1074	04-Jul-66	04-Jul-66	Lim, Fong	19 Cangkat Desa, Taman Desa, Kuala Lumpur 58100
785	12-Jun-53	12-Jun-53	Lines, John Dunstan	9 Fortune Street, Box Hill North, Vic. 3129
1683	15-May-91		Linke, Robert Clive	PO Box 3085 Tamarama, NSW 2026
1180	13-Nov-70	13-Nov-70	Linton, Trevor John	6 Lyall Avenue, Kerang, Vic. 3579
1526	19-Nov-81	19-Nov-81	Little, David Ian	PO Box 6166, Gold Coast M.C., Bundall, Qld 4217
704	19-Apr-48	19-Apr-48	Little, Gerald J.	4 Younger Court, Kew, Vic. 3101
1630	13-Oct-87	13-Oct-87	Livingstone, Bruce	PO Box 501, Buddina, Qld 4575
1032	26-Feb-65	26-Feb-65	Lock, Bryant C.	32 Derrington Street, Mount Gambier, SA 5920
1330	11-Dec-75	11-Dec-75	Locke, Ian R.	Address unknown
11062	26-Dec-65	26-Dec-65	Lodge, Alan William	9 Garie Street, Blackburn, Vic. 3130
107	27-Jun-67	27-Jun-67	Lodge, John William	156 David Hills Road, Monbulk, Vic. 3793
1484	24-Jul-80	24-Jul-80	Loechel, Robin Everard	16 St Andrews Terrace, Willunga, SA 5172
1687	16-Oct-91		Logan, Francis George	PO Box 492, Essendon, Vic. 3040
773	14-Nov-52	14-Nov-52	Long, Alan Ted	100 Grandview Grove, Rosanna, Vic. 3084
1572	14-Jun-84	14-Jun-84	Longden, Gregory Norman	13 Devon Drive, Blackburn, Vic. 3130
1501	07-May-81	07-May-81	Loughrey, Peter T.	35 Cotham Road, Kew, Vic. 3101
1175	05-Jun-70	05-Jun-70	Lovegrove, Richard Stephen	PO Box 75, Frenchs Forest, NSW 1640
1518	20-Oct-81	20-Oct-81	Lovelock, Andrew Michael	70 Dunns Road, Mount Martha, Vic. 3934

1610	21-Oct-86	21-Oct-86	Lowe, Thomas Stanley	Lot 75 Seagren Street, Cooktown, Qld 4871
1338	18-Dec-75	18-Dec-75	Loy, Michael John	PO Box 242, Greensborough, Vic. 3088
1215	08-Mar-72	08-Mar-72	Lum, Kong Sun	21 Castlewood Drive, Castle Hill, NSW 2154
1559	27-Oct-83	27-Oct-83	Lundgren, Robert Carl	20 Traydal Close, Wantirna, Vic. 3152
855	24-Jun-57	24-Jun-57	Lusk, Edwin Conrad Crichton	11 Wrendale Drive, Donvale, Vic. 3111
1174	05-Jun-70	05-Jun-70	Lutton, Ronald John	43 Mashie Way, Wodonga, Vic. 3690
1487	16-Oct-80	16-Oct-80	Luxmoore, David Alexander	2 Green Lane, Tallebudgera, Qld 4228
1590	18-Jul-85	18-Jul-85	Lynch, Christopher John	25 Pascall Street, Mount Waverley, Vic. 3149
1362	11-Nov-76	11-Nov-76	Lyon, Barry John	63 Heathmont Road, Ringwood, Vic. 3134
1627	17-Sep-87	17-Sep-87	Lyons, John Thomas	PO Box 9, Bannockburn, Vic. 3331
1200	02-Jul-71	02-Jul-71	Macaulay, Robert David	13 Baxter Street, Eltham, Vic. 3095
1688	22-Oct-91	22-Oct-91	MacDonald, Trevor John	7/22 Kingsley Street, Elwood, Vic. 3184
1458	18-Oct-79	18-Oct-79	Macey, John Francis	16 Tunbury Avenue, Ringwood, Vic. 3134
1034	26-Feb-65	26-Feb-65	Macey, Rody John	31 Fermanagh Road, Camberwell, Vic. 3124
834	23-May-56	23-May-56	MacIsaac, Angus James	8 Whitehorse Road, Deepdene, Vic. 3103
1285	03-Oct-74	03-Oct-74	Madden, John Damian	Address unknown
967	15-Jun-62	15-Jun-62	Madden, John Donal	Address unknown
1138	19-Aug-68	19-Aug-68	Maher, John T.	Address unknown
914	18-Nov-59	18-Nov-59	Maher, Thomas Michael	53 Rennison Street, Parkdale, Vic. 3195
1166	07-Aug-69	07-Aug-69	Mahon, Dennis E.	17 Namur Street, East Kew, Vic. 3102
1661	18-Jul-89	18-Jul-89	Malcolm, Peter F.	Pier 69, 2727 Alaskan Way, Seattle, Washington 98121, USA
1350	06-May-76	06-May-76	Male, David Maxwell	56 Victoria Street, Williamstown, Vic. 3016
1711	26-Oct-93	26-Oct-93	Mannix, James Daniel	90 Bondi Road, Bonbeach, Vic. 3196

1622	18-Apr-87	18-Apr-87	Mantyvirta, Paul H.	4 Sanderling Street, Werribee, Vic. 3030
1135	07-Aug-68	07-Aug-68	Marsella, Riccardo Giacomo	307 Main Street, Mornington Vic. 3931
823	28-Apr-55	28-Apr-55	Marshall, Basil John Thurloway	129 Napier Street, Stawell, Vic. 3380
1519	20-Oct-81	20-Oct-81	Martin, Gary John	PO Box 8, Dromana, Vic. 3936
1673	24-Apr-90	24-Apr-90	Martin, Rodney Ian	45 Pakington Street, Geelong West, Vic. 3218
1339	18-Dec-75	18-Dec-75	Marwick, Brian Keith	37 Worthing Avenue, East Doncaster, Vic. 3109
1227	27-Jun-72	27-Jun-72	Marx, Peter Julian	PO Box 93, Trafalgar, Vic. 3824
1015	26-Jun-64	26-Jun-64	Mason, Francis Edward	22 Avon Street, Bulleen, Vic. 3105
1520	20-Oct-81	20-Oct-81	Mason, Peter Jeffrey	15 Cord Close, Berwick, Vic. 3806
1780	22-May-00	22-May-00	Mason, Stuart Murray	9 Julie Place, Lavington, NSW 2641
1067	25-Mar-66	25-Mar-66	Mason, William Francis	12 Lloyd Court, St Albans Park, Vic. 3219
1510	18-Jun-81	18-Jun-81	Mathieson, Garry L.	474 Flinders Street, Melbourne, Vic. 3000
1258	14-Feb-74	14-Feb-74	Mau, Frank	8 Pohlman Street, Kyneton, Vic. 3444
1703	27-Oct-92	27-Oct-92	Mawson, Terry John	46 Miles Street, Ivanhoe, Vic. 3079
1644	19-Jul-88	19-Jul-88	Maxted, Christopher James	60 Main Street, Merimbula, NSW 2548
907	13-Nov-59	13-Nov-59	May, Arthur J.	13 Lantana Street, Nightcliff, NT 810
1094	29-Dec-66	29-Dec-66	McArthur, Duncan Stuart Russell,	PO Box 71, Blackburn South, Vic. 3130
1139	20-Aug-68	20-Aug-68	McAvoy, David John	P.O. Box 1696, Katherine, NT 851
1155	14-Mar-69	14-Mar-69	McCaffrey, John Patrick	7 Tenham Grove, Cheltenham, Vic. 3192
1784	07-Jul-00	07-Jul-00	McCarthy, Gabrielle Mary	6 Taronga Court, Nunawading, Vic. 3131
1674	24-Apr-90	24-Apr-90	McCarthy, Stephen John	PO Box 151, Moreland, Vic. 3058
1682	23-Apr-91	23-Apr-91	McCarthy, Peter Michael	8/179 Queen Street, Melbourne, Vic. 3000
836	23-May-56	23-May-56	McCarty, Kevin Victor	27 Sherbrooke Street, Ainslie, ACT 2602

1766	16-Feb-99	16-Feb-99	McCleave, Andrew Mark	P.O. Box 630, Armadale, Vic. 3143
1538	26-Oct-82	26-Oct-82	McColl, Wayne N.	3 Cormorant Place, Dingley, Vic. 3172
857	08-Aug-57	08-Aug-57	McComb, Raymond G.	31 Reynolds Street, Paynesville, Vic. 3880
962	28-Dec-61	28-Dec-61	McConchie, Ian L.	9 Reibey Place, Curtin, ACT 2605
961	01-Dec-61	01-Dec-61	McCoy, Francis J. G.	PO Box 687, Charters Towers, Qld 4820
1457	18-Oct-79	18-Oct-79	McCoy, Malcolm James	PO Box 360, Camberwell, Vic. 3124
1594	19-Dec-85	19-Dec-85	McCracken, Donald George	3/34 Faversham Road, Canterbury, Vic. 3126
1045	01-Jul-65	01-Jul-65	McCrohan, James Peter	119 Chapple Street, Wodonga, Vic. 3690
777	14-Nov-52	14-Nov-52	McDonald, Alan H.	2 Ajax Street, Balwyn North, Vic. 3104
879	14-May-58	14-May-58	McDonald, Alan P.	Address unknown
739	19-May-50	19-May-50	McDonald, Bernard Henry	8 The Promontory, Helensvale, Qld 4212
1048	05-Jul-65	05-Jul-65	McDonald, John Reid	PO Box 623, Torquay, Vic. 3228
1797	19-Jun-01		McDonald, Malcolm Andrew	44 Hampden Street, Mornington, Vic. 3941
752	18-Apr-51	18-Apr-51	McDonald, Maxwell Gray	1 Linden Street, Blackburn, Vic. 3130
1757	17-Jun-97	17-Jun-97	McDowell, Trevor Wayne	10138 Princes Highway, Allansford, Vic. 3277
1273	20-Jun-74	20-Jun-74	McFarland, Stuart Andrew	16A Waterloo Street, Camberwell, Vic. 3126
1466	07-Feb-80	07-Feb-80	McGrath, Peter D.	Address unknown
1129	24-Nov-67	24-Nov-67	McHugh, Stuart E.	405 Main Road, Styx, Christchurch, New Zealand
1741	26-Jun-95	26-Jun-95	McIntosh, Colin Ross	25 Kalimna Street, Balwyn, Vic. 3103
1020	10-Jul-64	10-Jul-64	McKenzie, Robert George	2 Brett Court, Cheltenham, Vic. 3192
1343	11-Mar-76	11-Mar-76	McKenzie, Garry Francis	PO Box 1695, Ballarat, Vic. 3354
1714	15-Dec-93	15-Dec-93	McKenzie, John Richard	6 Pelham Court, Point Lonsdale, Vic. 3225

1747	17-May-96	17-May-96	McKinley, Brian Anthony	12 Sturt Street, Beaufort, Vic. 3373
1746	16-Feb-96	16-Feb-96	McKinnon, Mark Andrew	14A Murray Road, Bentleigh, Vic. 3204
1642	17-May-88	17-May-88	McKinnon, Raymond M.	34 Joiner Street, Melville, WA 6156
1348	06-May-76	06-May-76	McLachlan, Ian Bruce	19 Remony Avenue, Highton, Vic. 3216
814	19-Nov-54	19-Nov-54	McLaren, Albert	14 Janice Street, Macleod, Vic. 3085
1363	11-Nov-76	11-Nov-76	McLaren, Charles Norman	3/64 Shady Grove, Nunawading, Vic. 3131
1116	10-Jul-67	10-Jul-67	McLaren, Quentin Phillip	121 Nambour Road, Bli Bli, Qld 4560
1502	07-May-81	07-May-81	McLean, Michael Alexander	188 McKean Street, North Fitzroy, Vic. 3068
1586	23-Apr-85	23-Apr-85	McLennan, David John	PO Box 36, Aireys Inlet, Vic. 3231
1280	12-Sep-74	12-Sep-74	McLeod, Arthur B.	PO Box 86, Merrylands, NSW 2160
1253	20-Sep-73	20-Sep-73	McMahon, Kevin John	17 Clark Street, Nedlands, WA 6009
1003	16-Dec-63	16-Dec-63	McMahon, Leo Patrick	74 Robertson Street, Sherwood, Qld 4075
1319	14-Aug-75	14-Aug-75	McMaster, Carl Grant	202/156 Pacific Highway, St Leonards, NSW 2065
815	19-Nov-54	19-Nov-54	McQuie, John Whitney	8 Kerr Street, Warrnambool, Vic. 3280
1286	03-Oct-74	03-Oct-74	Meehan, John P.	46 Dunstan Street, Preston, Vic. 3072
1816	26-Jun-02	26-Jun-02	Meehan, Michael John	108 Wyndham Street, Shepparton, Vic. 3630
1472	30-Apr-80	30-Apr-80	Meehan, Patrick Thomas	538 Riversdale Road, Camberwell, Vic. 3124
1465	14-Dec-79	14-Dec-79	Meers, Geoffrey Douglas	5/7 Solna Street, Tarragindi, Qld 4121
1250	06-Sep-73	06-Sep-73	Meggs, Ralph James	2 Iris Court Wangaratta, Vic. 3677
1141	03-Sep-68	03-Sep-68	Meinhardt, Phillip Waldemar	23 Heathfield Road, Brighton East, Vic. 3187
1418	06-Apr-78	06-Apr-78	Menzies, Roderick William	22 Bambridge Street, Weetangera, ACT 2614
1476	22-May-80	22-May-80	Menzies, Trevor William	PO Box 1696 Darwin, NT 801
1310	28-Feb-75	28-Feb-75	Merrigan, Peter John	21 Coolstore Road, Croydon, Vic. 3136
1686	11-Sep-91	11-Sep-91	Meumann, Axel Holm	24 Sharpley Avenue, Stawell, Vic. 3380

1147	13-Dec-68	13-Dec-68	Middleton, Alan James	402-406 Mair Street, Ballarat, Vic. 3350
675	08-Oct-46	08-Oct-46	Middleton, Colin Edward	20 Russell Street, Camberwell, Vic. 3124
1102	27-Jun-67	27-Jun-67	Middleton, John Garrick	27 King Street, Stawell, Vic. 3380
808	11-May-54	11-May-54	Miller, Ivan Clarence	3 Proudfoot Street, Mont Albert, Vic. 3127
1568	10-May-84	10-May-84	Miller, Geoffrey David	60 Rockley Avenue, Baulkham Hills, NSW 2153
853	28-May-57	28-May-57	Miller, Albert James Lynn	53 Cootamundra Place, Junortoun, Vic. 3551
1803	20-Nov-01	20-Nov-01	Millett, Christopher John	26 Addison Road, Black Forest, SA 5035
1252	20-Sep-73	20-Sep-73	Milliken, Barry Earl	PO Box 132, Shellharbour Sq, NSW 2529
1640	26-Apr-88	26-Apr-88	Milne, Noel Bryce	83 Hender Street, Ringwood East, Vic. 3135
1807	17-Apr-02	17-Apr-02	Minney, Anthony Dale	85 Kennedy Street, Hamilton, Vic. 3300
1696	29-Apr-92	29-Apr-92	Mitchell, David Peter	GPO Box 2476V, Melbourne, Vic. 3000
803	29-Apr-54	29-Apr-54	Mitchell, Kevin Albert	9 Berry Street, Box Hill North, Vic. 3129
1398	20-Oct-77	20-Oct-77	Mitchell, Thomas James	9 Corrigan Place, Mill Park, Vic. 3082
1552	19-May-83	19-May-83	Mitchell, Trevor Wayne	25 Campbell Court, Warrandyte, Vic. 3113
809	17-May-54	17-May-54	Mitchell, William	30 Monte Carlo, Wishart, Qld 4122
963	28-Dec-61	28-Dec-61	Mithen, Kevin F.	70 Hunter Road, Camberwell, Vic. 3124
1298	20-Feb-75	20-Feb-75	Mitsch, Brian Leslie	319 Victoria Street, Deniliquin, NSW 2710
1488	16-Oct-80	16-Oct-80	Mitton, Graeme Richard	Cumberland Hse 1/2-4 Island Drive, Cannonvale, Qld 4802
1727	16-Nov-94		Mocicka, Andrej Ludvik	34 Bonanza Road, Beaumaris, Vic. 3193
969	15-Jun-62	15-Jun-62	Moloney, Brian Edward	83 Nimmo Street, Essendon, Vic. 3040
743	16-Oct-50	16-Oct-50	Moloney, Thomas Myles	31 Miller Street, Essendon, Vic. 3040
812	19-Nov-54	19-Nov-54	Mommsen, Peter	16 Oxford Street, Hadfield, Vic. 3046

1260	21-Mar-74	21-Mar-74	Monahan, David John	PO Box 218, Preston, Vic. 3072
1027	09-Dec-64	09-Dec-64	Monger, Alan Edward	48 Boger Street, Benalla, Vic. 3672
1149	24-Jan-69	24-Jan-69	Montgomerie, John W.	12 Parkside Street, St Helliers, Auckland, New Zealand
1012	26-Jun-64	26-Jun-64	Moore, John Benson	23 Kingfisher Drive, Shepparton, Vic. 3630
1332	11-Dec-75	11-Dec-75	Moore, Malcolm Douglas	20/255 Drummond Street, Carlton, Vic. 3053
1386	21-Apr-77	21-Apr-77	More, Donald Henry	36 Nolan Drive, Tura Beach, NSW 2548
1173	21-Apr-70	21-Apr-70	Morphett, Gerald William	8 Annie Street, Caboolture, Qld 4510
1213	06-Mar-72	06-Mar-72	Morris, Christopher Charles	PO Box 140, Warragul, Vic. 3820
791	13-Oct-53	13-Oct-53	Morrison, Henry Donald	PO Box 427, Yankalilla, SA 5203
1614	20-Nov-86	20-Nov-86	Morrison, Peter Robert	34 Balcombe Road, Mentone, Vic. 3194
1261	21-Mar-74	21-Mar-74	Moxham, Brian David	80 Moores Road, Monbulk, Vic. 3793
1164	16-Jul-69	16-Jul-69	Muir, Kenneth Arthur	108 Wyndham Street, Shepparton, Vic. 3630
1114	07-Jul-67	07-Jul-67	Muir, Ian Thomas	46 Mitchell Street, Morningson, Vic. 3931
1256	13-Dec-73	13-Dec-73	Mulcahy, John D.	123 Johnson Street, Maffra, Vic. 3860
958	24-Nov-61	24-Nov-61	Mulcahy, Peter James	498 Victoria Pde, East Melbourne, Vic. 3002
1790	12-Dec-00	12-Dec-00	Muldowney, John David	15 Hill Street, Thornbury, Vic. 3071
1328	11-Sep-75	11-Sep-75	Muller, Neil James	70 Little John Road, Warranwood, Vic. 3134
1489	16-Oct-80	16-Oct-80	Muller, Roger Charles	6 Sherman Street, Bendigo, Vic. 3550
1384	21-Apr-77	21-Apr-77	Munro, Ian Bruce	115 Mine Road, Nutfield, Vic. 3099
1349	06-May-76	06-May-76	Murnane, Alexander Bruce	10 Barongarook Court, Lower Plenty, Vic. 3093
1503	07-May-81	07-May-81	Murphy, James Anthony	17 Phillips Crescent, Rosanna, Vic. 3084
1340	22-Jan-76	22-Jan-76	Murphy, Raymond J.	34 Heversham Drive, Seaford, Vic. 3198

1729	05-Dec-94	05-Dec-94	Murphy, Sharon Lee	51 High Street, Thirroul, NSW 2515
1005	05-Dec-63	05-Dec-63	Murray, James Douglas	12 Roma Street, Scoresby, Vic. 3179
1651	17-Jan-89		Murrell, Peter William	14 Linkside Court, Yallourn Heights, Vic. 3825
1702	22-Oct-92	22-Oct-92	Musgrave-Evans, Rachel	113 Telford Drive, Berwick, Vic. 3806
1187	26-Jan-71	26-Jan-71	Myers, Bernard F.	4 Mangosteen Close, Smithfield, Qld 4878
1459	18-Oct-79	18-Oct-79	Myers, Raymond	PO Box 71 Bundoora, Vic. 3083
1413	13-Apr-78	13-Apr-78	Nacha, Trevor Clemens	4 Dunlavin Road, Nunawading, Vic. 3131
1600	13-May-86	13-May-86	Nagel, William	42 Island Drive, Torquay, Vic. 3228
1638	15-Mar-88	15-Mar-88	Naismith, Brian Francis	PO Box 228, Gympie, Qld 4570
1122	26-Oct-67	26-Oct-67	Naughton, Anthony Edward	40 Flowerpot Crescent, Blackmans Bay, Tas. 7052
1142	04-Oct-68	04-Oct-68	Neale, Peter James	16 Marr Street, Myaree, WA 6154
1182	13-Jan-71	13-Jan-71	Nehill, Peter John	PO Box 1109, Kingscliffe, NSW 2487
866	12-Nov-57	12-Nov-57	Nestor, Raymond Joseph	4 Valewood Court, Narre Warren, Vic. 3805
1337	18-Dec-75	18-Dec-75	New, Clifford Brian	11 Turana Street, Doncaster, Vic. 3108
1473	30-Apr-80	30-Apr-80	Newnan, Christopher Philip	RMB 2073, Via Barnawartha, Vic. 3688
947	03-Apr-61	03-Apr-61	Nicholas, Malcolm Albert	1 Wingfield Avenue, Crawley, WA 6009
1597	13-May-86	13-May-86	Nicholson, Ross Andrew	6 Drummond Close, Donvale, Vic. 3111
1531	04-May-82	04-May-82	Niemiec, Edward Joseph	PO Box 511, Mulgrave, Vic. 3170
1351	06-May-76	06-May-76	Nilsson, Peter Field	45 Edward Street, Langwarrin, Vic. 3910
1613	20-Nov-86	20-Nov-86	Nisbet, Gary Robert	37 Neuparth Road, Croydon North, Vic. 3136
1429	04-Oct-78	04-Oct-78	Nobelius, Robin Peter	PO Box 461, Pakenham, Vic. 3810
1228	12-Jul-72	12-Jul-72	Noel, Antony Guy	29/56 Hooker Boulevard, Mermaid Waters, Qld 4218

1437	09-Nov-78	09-Nov-78	Nolan, Bernard Joseph	5 Garden Avenue, Nunderi, NSW 2484
708	01-Jun-48	01-Jun-48	Noonan, Kevin Joseph	9 Inner Crescent, Brighton Vic. 3186
1611	21-Oct-86	21-Oct-86	Norman, Alan David	28 Nepean Street, Watsonia, Vic. 3087
1769	15-Jun-99	15-Jun-99	North, Philip Henry	116 Military Road, Neutral Bay, NSW 2089
988	28-Jun-63	28-Jun-63	Northrop, David William Moyle	6 Coila Street, Turrumurra, NSW 2074
1539	26-Oct-82	26-Oct-82	Norton, Timothy Gerard	1 Molesworth Street, Kew, Vic. 3101
1336	11-Dec-75	11-Dec-75	O'Brien, Anthony Gorman	27 McConchie Avenue, East Kew, Vic. 3102
1743	06-Sep-95	06-Sep-95	O'Brien, Noel Reginald	9 Carl Jung Court, Victoria Point, Qld 4165
1474	30-Apr-80	30-Apr-80	O'Brien, Philip Gerard	29 Jeffrey Street, Bentleigh, Vic. 3204
1462	22-Nov-79	22-Nov-79	O'Brien, Russel James	PO Box 3100, Bendigo Delivery Centre, Vic. 3554
1521	20-Oct-81	20-Oct-81	O'Callaghan, Phillip John	PO Box 294 Ashmore City, Qld 4214
996	05-Jul-63	05-Jul-63	O'Connor, Patrick J.	10 Sloans Road, Warrandyte, Vic. 3113
1811	22-May-02	22-May-02	O'Grady, Brent Kevin	8 Thrums Court Hamlyn Heights, Vic. 3215
1433	14-Oct-78	14-Oct-78	O'Malley, Martin Edward	21 View Road, The Patch, Vic. 3792
734	19-Oct-49	19-Oct-49	O'Meara, Howard J.	7 Roper Place Chifley, ACT 2606
1506	07-May-81	07-May-81	O'Neill, Gregory Robert	54 Power Street, Croydon North, Vic. 3136
1490	16-Oct-80	16-Oct-80	O'Neill, Peter William	70 Ogilvie Street, Essendon, Vic. 3040
1545	18-Nov-82	18-Nov-82	O'Neill, Philip J.	Lot 115 Second Avenue, Cockatoo, Vic. 3781
1115	16-Jul-67	16-Jul-67	Octigan, Frederick Brian	6 Barnet Street, Highett, Vic. 3190
1460	18-Oct-79	18-Oct-79	Ogleby, Clifford Leslie	147 Cramer Street, Preston, Vic. 3072
1813	22-May-02	22-May-02	Onley, Anthony Martin	PO Box 416, Shepparton, Vic. 3632
1499	07-May-81	07-May-81	Oxley, Stephen John	PO Box 382, Wangaratta, Vic. 3676
636	05-Oct-36	05-Oct-36	Page, Ronald Charles	52/47 Eve Road, Bellevue Heights, SA 5050

1326	14-Aug-75	14-Aug-75	Paramanathan, Kandiah	35 Alex Avenue, Wheelers Hill, Vic. 3150
1021	16-Jul-64	16-Jul-64	Parker, John Richard	PO Box 110, Brunswick East, Vic. 3057
1055	08-Feb-66	08-Feb-66	Parr, Milton Douglas	12 Ballam Close, Frankston, Vic. 3199
1334	11-Dec-75	11-Dec-75	Parsons, Maxwell James	125 Garden Hill Court, Kangaroo Ground, Vic. 3097
1641	26-Apr-88	26-Apr-88	Patching, Warren Kenneth	72 Aldinga Street, Blackburn South, Vic. 3130
794	03-Dec-53	03-Dec-53	Pathe, Basil Rex	10 Sternberg Road, Maleny, Qld 4552
1477	22-May-80	22-May-80	Patterson, Geoffrey Robert	22 Kingfisher Gardens, Brunswick East, Vic. 3057
1399	20-Oct-77	20-Oct-77	Pattison, William Kevin	9 Octavia Street, St Kilda, Vic. 3182
1159	20-Jun-69	20-Jun-69	Paul, John McVey	14 Dirkala Avenue, Heathmont, Vic. 3135
1681	23-Jan-91	23-Jan-91	Peacock, Kenneth John	21 Menzie Grove, Ivanhoe, Vic. 3079
1262	21-Mar-74	21-Mar-74	Pearce, Bruce George	19 Hale Avenue, Mt Clear, Vic. 3350
925	28-Jun-60	28-Jun-60	Pedler, Donald Alexander	P.O. Box 171, Merbein, Vic. 3505
1441	12-Apr-79	12-Apr-79	Perfect, Ross	63 Reinhold Crescent, Chermside, Qld 4032
845	14-Jan-57	14-Jan-57	Perger, John	17 Settlers Road, Yowaka, NSW 2549
1652	17-Jan-89	17-Jan-89	Perriam, Malcolm John	1 Baradine Terrace, Donvale, Vic. 3111
1390	11-Aug-77	11-Aug-77	Perry, Donald James	62 McLachlan Street, Horsham, Vic. 3400
1596	13-May-86	13-May-86	Perry, Lindsay John	PO Box 208, Croydon, Vic. 3136
697	29-Sep-47	29-Sep-47	Peters, Robert Sargent	PO Box 200, Moe, Vic. 3824
1047	05-Jul-65	05-Jul-65	Petris, Nicholas	PO Box 714, Belgrave, Vic. 3160
1068	25-Mar-66	25-Mar-66	Peyton, Peter Brian	7 Vine Street, Heidelberg, Vic. 3084
1478	22-May-80	22-May-80	Phibbs, Anthony John	15 Hazel-Smith Crescent, Oxley, ACT 2903
1719	14-Apr-94	14-Apr-94	Phillips, David Graham	PO Box 959, Renmark, SA 5341

1419	06-Apr-78	06-Apr-78	Phillips, Grant H.	P.O. Box 1391, Rockhampton, Qld 4700
1400	20-Oct-77	20-Oct-77	Phillips, Michael	109 Diamantina Crs, Kaleen, ACT 2617
1108	28-Jun-67	28-Jun-67	Phizacklea, Nikolas Antony	5/303 Burwood Highway, Burwood East, Vic. 3151
1385	21-Apr-77	21-Apr-77	Pinnell, Phillip Burns	16 French Street, Mount Waverley, Vic. 3149
1039	09-Mar-65	09-Mar-65	Pitt, Evan Edwin	36 Odenwald Road, Eaglemont, Vic. 3084
1269	21-Mar-74	21-Mar-74	Pitt, John Leslie	PO Box 974, Mildura, Vic. 3502
1479	22-May-80	22-May-80	Plokstys, Richard Raymond	30 Terry Road, Denistone, NSW 2114
1323	14-Aug-75	14-Aug-75	Plumb, Colin John	37 Shasta Avenue, East Brighton, Vic. 3187
1783	07-Jul-00	07-Jul-00	Podolczak, John Andrew	345 Konagaderra Road, Sunbury, Vic. 3429
1042	22-Mar-65	22-Mar-65	Porteous, Andrew Alastair	23 Hamilton Street, Subiaco, WA 6008
1136	14-Aug-68	14-Aug-68	Porter, Kevin William	2 Nolan Street, Ballarat, Vic. 3350
1728	16-Nov-94		Poulton, Andrew Robert	7A Violet Crescent, Brighton East, Vic. 3187
992	21-Jun-63	21-Jun-63	Powell, Malcolm Hugh	10/589 Collins Street, Melbourne, Vic. 3000
1566	17-Apr-84	17-Apr-84	Power, Vincent James	5 Carlyle Close, Hurstbridge, Vic. 3099
1092	29-Dec-66	29-Dec-66	Poynton, Barrie George	15 Vivian Street, Belmont, Vic. 3216
1191	23-Mar-71	23-Mar-71	Pratt, Robert Corbit Miles	PO Box 2781, Alice Springs, NT 871
817	19-Nov-54	19-Nov-54	Price, Lawrence John	4 Arundel Avenue, Glenroy, Vic. 3046
1391	11-Aug-77	11-Aug-77	Price, Philip Raymond	PO Box 313, Kerang, Vic. 3579
1716	16-Mar-94		Price, Robert William	12 May Street, Hampton, Vic. 3188
1354	06-May-76	06-May-76	Prikulis, Robert Janis	PO Box 100, Bangalow, NSW 2479
1112	06-Jul-67	06-Jul-67	Privett, Leigh Gordon	1/695 Hodge Street, North Albury, NSW 2640
970	15-Jun-62	15-Jun-62	Procter, Maxwell Aubrey	12 Kooroui Court, Drysdale, Vic. 3222
1706	18-Jun-93	18-Jun-93	Pumpa, Timothy Ross	26 John Rowell Lane, Mornington, Vic. 3931

1799	17-Jul-01	17-Jul-01	Purbrick, Oliver Michael	143 Spensley Street, Clifton Hill, Vic. 3068
1721	15-Jun-94	15-Jun-94	Purnell, Richard David	21 Ridgehaven Circuit, Leanyer, NT 812
1181	21-Dec-70	21-Dec-70	Pyke, Kieth Maxwell	12 Woorilla Court, Frankston, Vic. 3199
1305	26-Feb-75	26-Feb-75	Quake, Ian Hugh	RMB 3385 Roches Road, Trafalgar, Vic. 3824
1046	05-Jul-65	05-Jul-65	Quinert, John G.	20 Link Avenue, Kilmore, Vic. 3764
1522	21-Oct-81	21-Oct-81	Quirk, Gary James	54 Brentwood Drive, Wantirna, Vic. 3152
1699	20-May-92	20-May-92	Rabbling, Mary Catherine	PO Box 360, Camberwell, Vic. 3124
1240	01-Nov-72	01-Nov-72	Ramm, Peter Julian	30 Mariana Avenue, Croydon, Vic. 3136
1265	21-Mar-74	21-Mar-74	Ramsdale, Michael Alexander	PO Box 174, Preston, Vic. 3072
1376	10-Mar-77	10-Mar-77	Randall, Keith Robert	PO Box 111, New Lambton, NSW 2305
1500	07-May-81	07-May-81	Rankin, Murray John	Boisdale Street, Maffra, Vic. 3860
861	06-Nov-57	06-Nov-57	Ransom, John Ulrick	PO Box 135, Mawson, ACT 2607
1587	23-Apr-85	23-Apr-85	Raphael, David Neville	PO Box 1223, Hervey Bay, Qld 4655
1481	22-May-80	22-May-80	Raso, Angelo Vincent	11 Meribil Close, Mount Eliza, Vic. 3930
1562	15-Dec-83	15-Dec-83	Ratten, Leith McDonald	PO Box 24, Landsborough, Qld 4650
1222	05-Jun-72	05-Jun-72	Raven, Calvin F.	125 Edgevale Road, Kew, Vic. 3101
1075	04-Jul-66	04-Jul-66	Read, Russell John	2 Coleman Street, Heathmont, Vic. 3135
1778	18-Apr-00	18-Apr-00	Reay, Andrew John	60 Forest Road, Ferntree Gully, Vic. 3156
865	12-Nov-57	12-Nov-57	Rebbechi, Brian Anthony	PO Box 756, Wangaratta, Vic. 3676
1403	20-Oct-77	20-Oct-77	Reddie, Michael James	PO Box 268, Berwick, Vic. 3806
1132	06-Feb-68	06-Feb-68	Redwood, Kenneth G.	56 Hudson Fysh Avenue, Darwin, NT 800
1154	24-Feb-69	24-Feb-69	Reed, Harry James	755 Corangamite Lake Road, Coragulac, Vic. 3249
872	02-May-58	02-May-58	Reed, Kenneth Albert	GPO Box 2240, Melbourne, Vic. 3001

1759	16-Dec-97	16-Dec-97	Rendle, David Reginald	16 Illouera Avenue, Grovedale, Vic. 3216
1370	16-Dec-76	16-Dec-76	Rennick, Mark Baden	11 Lancaster Street, Bentleigh East, Vic. 3165
1352	06-May-76	06-May-76	Rice, Patrick	PO Box 6622, St. Kilda Road Central, Vic. 8008
1704	18-Nov-92	18-Nov-92	Richards, Robert Charles	PO Box 1568, Wodonga, Vic. 3689
810	12-Jul-54	12-Jul-54	Richards, Thomas W.	PO Box 387, Lae, Papua New Guinea
973	15-Jun-62	15-Jun-62	Richardson, Kenneth William Grey	2B Pier Road, Inverloch, Vic. 3996
1608	21-Oct-86	21-Oct-86	Rickard, Peter John	63 Kooyongkoot Road, Hawthorn, Vic. 3122
1700	27-Oct-92	27-Oct-92	Riddell, Matthew Robert	PO Box 2038, Srawberry Hills, NSW 2012
921	27-Jun-60	27-Jun-60	Riddell, James Allison	10 Jinka Street, Hawker, ACT 2614
1809	22-May-02	22-May-02	Riddington, Bradley Ian	353 Plenty Road, Preston, Vic. 3072
766	17-Apr-52	17-Apr-52	Ripper, Edwin George	3 Valley View Court, Glen Waverley, Vic. 3150
1819	11-Sep-02	11-Sep-02	Rob, Stuart Douglas	PO Box 919, Geelong, Vic. 3220
1161	26-Jun-69	26-Jun-69	Roberts, John Lempriere	88 Thomas Street, Hampton, Vic. 3188
1096	04-Jan-67	04-Jan-67	Roberts, Kenneth John	PO Box 1029, Collingwood, Vic. 3066
1104	27-Jun-67	27-Jun-67	Roberts, Terrence Aidan	98 Bellbird Road, Mount Eliza, Vic. 3930
1588	23-Apr-85	23-Apr-85	Robins, Philip James	59 Waterview Court, Croydon Hills, Vic. 3136
754	21-May-51	21-May-51	Robinson, Alan Charles	Address unknown
757	22-Oct-51	22-Oct-51	Robinson, Francis William	51 Sixth Street, Parkdale, Vic. 3194
683	14-Apr-47	14-Apr-47	Roche, Robert Laurence	380 Napier Street, Bendigo, Vic. 3550
971	15-Jun-62	15-Jun-62	Rogalsky, Richard	7 Francis Street, South Melbourne, Vic. 3205
1430	04-Oct-78	04-Oct-78	Rogan, Michael Francis	5 Hamilton Street, Gisborne, Vic. 3437
1536	15-Jul-82	15-Jul-82	Rogers, Colin Geoffrey	5 Castles Place, Melba, ACT 2615

1491	16-Oct-80	16-Oct-80	Rogers, Peter Robert	2/60 Bay Road, Sandringham, Vic. 3191
1234	03-Aug-72	03-Aug-72	Rolley, Alan Edward	GPO Box 5175AA, Melbourne, Vic. 3001
1249	06-Sep-73	06-Sep-73	Romeril, Ian Keith	Level 15, 570 Bourke Street, Melbourne, Vic. 3000
1406	09-Feb-78	09-Feb-78	Ronaldson, Philip G.	Address unknown
1186	26-Jan-71	26-Jan-71	Rose, Allan William	15/570 Bourke Street, Melbourne, Vic. 3000
1011	01-May-64	01-May-64	Ross, Alan Neil	72 Francis Road, RD2 Omokoroa, Tauranga, New Zealand
902	14-Jul-59	14-Jul-59	Ross, Barry Loyd	PO Box 537, Mansfield, Vic. 3724
1448	28-Jun-79	28-Jun-79	Ross, Ian C.	Lot 503 Summit Road, Mundaring, WA 6073
1091	22-Dec-66	22-Dec-66	Ross, Robert William	11 Fords Road, Gruyere, Vic. 3770
1732	26-Apr-95	26-Apr-95	Rotherham, Andrew Alfred	PO Box 3184, Albury, NSW 2640
891	28-Apr-59	28-Apr-59	Rothnie, Alexander J.	12 Hygeia Parade, Ringwood, Vic. 3134
1101	27-Jun-66	27-Jun-66	Rubeli, Maxwell Neil	49 Guildford Road, Surrey Hills, Vic. 3127
1480	22-May-80	22-May-80	Rudd, Phillip John	6 Wilfred Court, Palmerston, NT 830
959	24-Nov-61	24-Nov-61	Ruddell, Rodney Reginald	1 Carmel Court, Bentleigh East, Vic. 3165
915	19-Nov-59	19-Nov-59	Ruff, Helmut	26/41 Elizabeth Street, Bayswater, Vic. 3153
1631	13-Oct-87	13-Oct-87	Runting, Alan Leslie	2/86 Mt. Eliza Way, Mt. Eliza, Vic. 3930
1569	10-May-84	10-May-84	Runting, Christopher Ian	21 Box Hill Crescent, Mont Albert North, Vic. 3129
1528	18-Feb-82	18-Feb-82	Rutherford, John Edwin	22 Dacre Street, Toowong, Qld 4066
767	17-Apr-52	17-Apr-52	Ryder, Donald Charles	1/59 Keon Street, Thornbury, Vic. 3071
1666	24-Jan-90	24-Jan-90	Sach, David I.	12/18 Houston Street, Larrakeyah, NT 820
1311	28-Feb-75	28-Feb-75	Sadler, Michael Joseph	152 MacLeod Street, Barinsdale, Vic. 3875
1802	18-Dec-01	18-Dec-01	Salter, Duncan Eric	52A Sydney Street, Kilmore, Vic. 3764

1143	14-Oct-68	14-Oct-68	Salter, Eric George	PO Box 154, Kilmore, Vic. 3764
1414	13-Apr-78	13-Apr-78	Sanderson, Lyndon R.	Address unknown
1777	15-Feb-00	15-Feb-00	Sargent, Mark Christopher	144 Welsford Street, Shepparton, Vic. 3630
1394	11-Aug-77	11-Aug-77	Saunders, Gerald V.	PO Box 127, Rockhampton, Qld 4700
1185	26-Jan-71	26-Jan-71	Sawynok, William	142 Venables Street, North Rockhampton, Qld 4701
1709	18-Jun-93	18-Jun-93	Scardamaglia, Domenic	87 Collier Crescent, Brunswick West, Vic. 3055
1667	24-Jan-90	24-Jan-90	Schneider, Graeme John	Clarendon Street, Baddaginnie, Vic. 3670
1026	09-Dec-64	09-Dec-64	Scott, Trevor James	6 Moray Parade, Saratoga, NSW 2251
1072	10-Jun-66	10-Jun-66	Scott, Peter	Address unknown
1010	20-Mar-64	20-Mar-64	Seah, Kok Seang	18 Setiamurni, 12 Damansara Height, Kuala Lumpur 50490, Malaysia
802	28-Apr-54	28-Apr-54	Semmel, Desmond F.	1470 North Road, Clayton, Vic. 3168
1535	17-Jun-82	17-Jun-82	Setter, Craig	31 Wellington Drive, Balgownie, NSW 2519
833	26-Apr-56	26-Apr-56	Shacklock, George Ronald	3 Glenmore Court, Seaford, Vic. 3198
1126	10-Nov-67	10-Nov-67	Shacklock, Terence	87 Valley Parade, Glen Iris, Vic. 3146
1534	20-May-82	20-May-82	Sharp, Peter Leslie James	42 Raleigh Street, Forest Hill, Vic. 3131
1232	26-Jul-72	26-Jul-72	Shaw, Geoffrey John	8 Hopetoun City of Bendigo, Vic. 3550
1063	25-Jan-66	25-Jan-66	Shaw, Graham Norman	1 Windsor Avenue Mount Waverley, Vic. 3149
1810	22-May-02	22-May-02	Sheaves, Kevin Arthur	35 Bilbul Avenue, Rosebud South, Vic. 3939
1056	10-Mar-66	10-Mar-66	Shelden, Terence John	4 Walsh Street, Deepdene, Vic. 3103
1247	02-Aug-73	02-Aug-73	Shepherd, Ronald Malcolm	4 Leflan Close, North Ringwood, Vic. 3134
667	17-Apr-45	17-Apr-45	Sherwood, John Douglas	110 Kanooka Grove, Clayton, Vic. 3168

1364	11-Nov-76	11-Nov-76	Shone, Gerald Robert	51 Lawson Way, Endeavour Hills, Vic. 3802
1511	18-Jun-81	18-Jun-81	Sidley, David James	44 Vanberg Road, Essendon, Vic. 3040
1365	11-Nov-76	11-Nov-76	Siew, Kai Leong	3 Minchinbury Drive, Vermont South, Vic. 3133
1788	21-Nov-00	21-Nov-00	Signorini, Robert John	PO Box 1029, Collingwood, Vic. 3066
1787	21-Nov-00	21-Nov-00	Silcock, David Martin	28 Collins Place, Ringwood East, Vic. 3134
1274	20-Jun-74	20-Jun-74	Sim, Kevin John	129 Joel Terrace, Mount Lawley, WA 6050
690	14-Apr-47	14-Apr-47	Sim, Edward Linney	60 Well Street, Brighton, Vic. 3186
1659	18-Jul-89	18-Jul-89	Simpson, Alan Halstead	PO Box 421, Warrnambool, Vic. 3280
1598	13-May-86	13-May-86	Simpson, Richard Alan	Carson Simpson Pl, PO Box 219, Box Hill, Vic. 3128
700	12-Apr-48	12-Apr-48	Simpson, . Ronald H	66 Windella Avenue, Kew East, Vic. 3102
1764	19-May-88	19-May-88	Sinclair, Ian Mayne	21 Bouverie Street, Carlton, Vic. 3053
1546	18-Nov-82	18-Nov-82	Sinclair, David Gordon	41 Boundary Street, South Brisbane, Qld 4101
1157	23-May-69	23-May-69	Singleton, Clive Reginald	4 Kooringa Road, Carnegie, Vic. 3163
1632	13-Oct-87	13-Oct-87	Singleton, Ross David	596 North Road, Ormond, Vic. 3204
1146	12-Dec-68	12-Dec-68	Skehan, Anthony James	21 Maxwell Bronn Drive, Southport, Qld 4215
1289	07-Nov-74	07-Nov-74	Skitch, Robert Francis	'Tanglin', 44 Beams Road, Boondall, Qld 4034
1753	21-Jan-97	21-Jan-97	Slattery, Damian Leo	9 Hillrise Crt, Pakenham, Vic. 3810
1040	11-Mar-65	11-Mar-65	Slattery, Thomas O'Brien	PO Box 215 Pakenham, Vic. 3810
1633	13-Oct-87	13-Oct-87	Sloan, David Geoffrey	3/151 Newcastle Street, Fyshwick, ACT 2609
822	22-Apr-55	22-Apr-55	Smallman, Thomas Gustavus	64 Yarralumla Drive, Langwarrin, Vic. 3910
1752	21-Jan-97	21-Jan-97	Smith, Andrew Clinton	8 Erica Crescent, Kilsyth, Vic. 3137
1668	24-Jan-90	24-Jan-90	Smith, Andrew James	15 Maroondah Highway, Croydon, Vic. 3136
1653	17-Jan-89	17-Jan-89	Smith, Andrew Malcolm	45 Inchcape Avenue, Wantirna, Vic. 3152

1650	13-Dec-88	13-Dec-88	Smith, Barry Robert	PO Box 369, Lilydale, Vic. 3140
1103	27-Jun-67	27-Jun-67	Smith, David Harold	3/3 Jinka Street, Hawker, ACT 2614
854	06-Jun-57	06-Jun-57	Smith, Mervyn John	16 Mortimer Street, Werribee, Vic. 3030
726	16-May-49	16-May-49	Smith, Raymond Robert	124 The Lakes, Kings Rd, Taylors Lakes, Vic. 3038
1342	22-Jan-76	22-Jan-76	Smith, Rowan Malcolm	75 Twelfth Avenue, Raymond Island, Vic. 3880
1628	17-Sep-87	17-Sep-87	Smith, Trevor John Gee	11 Mitchell Street, Seaview Downs, SA 5049
1570	10-May-84	10-May-84	Smith, William Bruce Roy	Address unknown
1438	09-Nov-78	09-Nov-78	Snowden, William Klite	1 Bramble Street, Clifton Beach, Qld 4879
1691	02-Dec-91	02-Dec-91	Sommerville, Mark James	142 Bellair Street, Kensington, Vic. 3031
824	04-Apr-55	04-Apr-55	Sparrow, Desmond John	1 Ealing Court, Glen waverley, Vic. 3150
990	21-Jun-63	21-Jun-63	Speedie, Peter Grahame	11 Alameda Avenue, Mornington, Vic. 3931
1325	14-Aug-75	14-Aug-75	Speirs, Gregory Ian	33 Playne Street, Heathcote, Vic. 3523
1782	27-Jun-00	27-Jun-00	Sprott, James	3/32 Judd Street, Camberwell, Vic. 3124
1237	04-Aug-72	04-Aug-72	St Clair, Barry Talbot	8 Barrington Court, Baxter, Vic. 3911
1421	11-May-78	11-May-78	St Quentin, Grant Leslie	PO Box 919, Geelong, Vic. 3220
1464	14-Dec-79	14-Dec-79	Stansfield, Mark Oswald	12 Comer Street, Brighton East, Vic. 3187
1119	14-Jul-67	14-Jul-67	Steel, Michael P.	4 Marbray Drive Glen Waverley, Vic. 3150
1609	21-Oct-86	21-Oct-86	Steel, Robert E.	RMB 3980 Clarkes Lane Wangaratta, Vic. 3677
1577	15-Nov-84	15-Nov-84	Steele, Richard John	Dawson Street North, Ballarat, Vic. 3350
1812	22-May-02	22-May-02	Steigenberger, Gary John	PO Box 416, Shepparton, Vic. 3632
840	31-May-56	31-May-56	Stenhouse, Norman Edward	1457MacIntosh Road, Boolarra, Vic. 3870
1392	11-Aug-77	11-Aug-77	Stening, Paul F.	6/37 Hope Street, South Yarra, Vic. 3141
1483	24-Jul-80	24-Jul-80	Steward, Michael	114 Kennedy Street, Howlong, NSW 2640

1825	18-Dec-02	18-Dec-02	Stewart, Craig Malcolm	30 Mont Vue, Lilydale, Vic. 3140
1085	19-Jul-66	19-Jul-66	Stokes, Colin Howard	20 Corporate Drive, Moorabbin, Vic. 3189
1321	10-Jul-75	10-Jul-75	Stone, Graeme Edward	16 Jervis Street, Camberwell, Vic. 3124
933	07-Sep-60	07-Sep-60	Stott, Douglas McEwan	5 Isabella Place, Kiama, NSW 2533
858	13-Aug-57	13-Aug-57	Stott, Laurence W.	3 Egmont Close, Clifton Beach, Qld 4871
1415	13-Apr-78	13-Apr-78	Strachan, Andrew James	538 Riversdale Road, Camberwell, Vic. 3124
868	19-Nov-57	19-Nov-57	Streatfield, Ronald L.	Address unknown
1251	20-Sep-73	20-Sep-73	Street, Neil William	8 Avonbury Crt, Brighton, Vic. 3186
1013	26-Jun-64	26-Jun-64	Strong, John Stanley	GPO Box 5175AA, Melbourne, Vic. 3001
1707	18-Jun-93	18-Jun-93	Sullivan, Alan Leonard	PO Box 37, Isle of Capri, Qld 4217
955	15-Jun-61	15-Jun-61	Sullivan, Brian James	62 St Albans Street, Mount Waverley, Vic. 3149
1504	07-May-81	07-May-81	Sullivan, Peter Francis	17 Clarke Cres, Wantirna South, Vic. 3152
1805	19-Feb-02	19-Feb-02	Sullivan, Thomas Gerard	Address unknown
1416	13-Apr-78	13-Apr-78	Supple, Raymond G.	55 Victoria Road, Malvern, Vic. 3144
1110	30-Jun-67	30-Jun-67	Sutherland, Ian McDonald	PO Box 140, Jamison Centre, Macquarie, ACT 2614
1482	19-Jun-80	19-Jun-80	Sutherland, Geoffrey Peter	4 Jeanette Close, Greensborough, Vic. 3088
1669	21-Jan-90	21-Jan-90	Swales, Michael Barry	143 Koornalla Crescent, Mount Eliza, Vic. 3930
1444	26-Apr-79	26-Apr-79	Szirom, George Michael	PO Box 226, Niddrie, Vic. 3042
1193	25-Mar-71	25-Mar-71	Szwaj, John	173 Drummond Street, Carlton, Vic. 3107
1098	26-Jun-67	26-Jun-67	Tait, James G.	PO Box 56, Turrumurra, NSW 2074
964	14-Dec-61	14-Dec-61	Tattam, Robin Josiah	13 Carrington Street, Robinvale, Vic. 3549
716	25-Oct-48	25-Oct-48	Taylor, Ian C.	71 Centre Road, Brighton East, Vic. 3187

1461	18-Oct-79	18-Oct-79	Taylor, James Atwell	1 Wood Street, Thomastown, Vic. 3076
908	16-Nov-59	16-Nov-59	Taylor, John Inchiquin	4 Alton Avenue, Brighton, Vic. 3186
781	02-Apr-53	02-Apr-53	Taylor, John Keith	3 Newman Street, Yarralumla, ACT 2600
737	26-Apr-50	26-Apr-50	Taylor, Russell D.	187 Roberts Road, Subiaco, WA 6008
1170	31-Oct-69	31-Oct-69	Taylor, William F.	276 Middleborough Road, Blackburn South, Vic. 3130
1606	21-Aug-86	21-Aug-86	Teakle, Mark Ronald Bray	29 Ferrers Street, Mount Gambier, SA 5900
1679	23-Jan-91	23-Jan-91	Terjesen, Bradley William	PO Box 247, Croydon, Vic. 3136
1733	26-Apr-95	26-Apr-95	Terrens, Richard John	167 Bastings Street, Northcote, Vic. 3070
1525	29-Oct-81	29-Oct-81	Tham, Francis Kah Heen	7 Allison Crescent, Eltham, Vic. 3095
1268	21-Mar-74	21-Mar-74	Thiele, Kevin Noel	5 Stanley Avenue, Spring Gully, Bendigo, Vic. 3550
1022	08-Jul-64	08-Jul-64	Thomas, Barry J.	“Cooattalla”, Arthurs Creek Road, Arthurs Creek, Vic. 3099
1589	23-Apr-85	23-Apr-85	Thomas, John Craig	4 Bond Place, Carindale, Qld 4152
932	19-Jul-60	19-Jul-60	Thomas, John Roderick	40 Boardman Close, Box Hill South, Vic. 3128
1492	16-Oct-80	16-Oct-80	Thomas, Wayne Bennett	PO Box 1, Warburton, Vic. 3799
881	18-Aug-58	18-Aug-58	Thompson, Alan A.	29 Gower Street, Glenelg East, SA 5045
1095	30-Dec-66	30-Dec-66	Thompson, David H.	Centre 9, William Street, Beaudesert, Qld, 4285
1739	20-May-95	20-May-95	Thompson, Gregory Raymond	1/110 Rouje Street, Port Melbourne, Vic. 3207
864	01-Nov-57	01-Nov-57	Thompson, James Alex	21 Elata Street, Oakleigh South, Vic. 3167
909	16-Nov-59	16-Nov-59	Thoms, Graeme William	110 Camden Road, Newtown, Vic. 3220
850	29-Apr-57	29-Apr-57	Thomson, Geoffrey Howard Vernon	283 Lawrence Road, Mount Waverley, Vic. 3149
1690	27-Nov-91	21-Aug-98	Thomson, Lloyd	PO Box 766, Mildura, Vic. 3502
1523	20-Oct-81	20-Oct-81	Thorpe, Alan William	38 Mitchell Street, Darwin, NT 800

987	26-Jun-63	26-Jun-63	Timcke, Alan Edward	15 Faircroft Avenue, Glen Iris, Vic. 3146
927	26-Jun-60	26-Jun-60	Todd, Raymond J.	1A Craighill Road, St Georges, SA 5064
1431	04-Oct-78	04-Oct-78	Toleman, Kenneth Barry	18A Kingsley Street, Camberwell, Vic. 3124
1230	18-Jul-72	18-Jul-72	Toll, Michael Alan	PO Box 416, Shepparton, Vic. 3632
1366	11-Nov-76	11-Nov-76	Tomkinson, Mark Charles	20/255 Drummond Street, Carlton, Vic. 3053
1134	06-Aug-68	06-Aug-68	Tomkinson, Paul Thomas	Level 4, 370 St Kilda Rd, Melbourne, Vic. 3004
1574	17-Oct-84	17-Oct-84	Toole, Peter Alan	33 Murray Street, Wonthaggi, Vic. 3995
1623	28-Apr-87	28-Apr-87	Toose, Kenneth Raymond	541 Hampton Street, Hampton, Vic. 3188
942	12-Dec-60	12-Dec-60	Tracey, Ross H.	Address unknown
1467	07-Feb-80	07-Feb-80	Tregenza, Gary Edward	RMB 1380, O'Rielly's Hill Rd, Jumbik Via Yinnar, Vic. 3869
1675	24-Apr-90	24-Apr-90	Treloar, Paul	13 Castleton Drive, Vic. 3058
856	27-Jun-57	27-Jun-57	Trevena, William	11 Trevelyan Street, Elsternwick, Vic. 3185
1287	03-Oct-74	03-Oct-74	Trezise, Ian Rowlan	10 Banksia Place, Manukau City, Auckland, New Zealand
1117	13-Jul-67	13-Jul-67	Tuder, Graeme Stanley	PO Box 7, Nedlands, WA 6909
1401	20-Oct-77	20-Oct-77	Tulberg, James Robert	18 Egmont Street, Benalla, Vic. 3672
847	25-Mar-57	25-Mar-57	Tulloch, Gregory Erroll	34 Lincoln Road, Croydon, Vic. 3136
1353	06-May-76	06-May-76	Tulloch, John Ernest	Level 15, 570 Bourke St, Melbourne, Vic. 3000
1595	06-Mar-86	06-Mar-86	Tulloch, Paul D.	Dept Environment & Natural Resource Adelaide, SA 5000
1619	19-Mar-87		Turk, Andrew Glenn	South Street, Murdoch, WA 6150
628	06-Apr-36	06-Apr-36	Turnbull, John E.	11 Vale Street, Leura, NSW 2780
930	05-Jul-60	05-Jul-60	Turner, Brian Mansfield	37 Kilcatten Rise, Rowville, Vic. 3178
1557	23-May-83	23-May-83	Turner, Geoffrey James	152 Reserve Road, Beaumaris, Vic. 3193

841	31-May-56	31-May-56	Turner, John Crofts	45 Bogong Avenue, Glen Waverley, Vic. 3150
1367	11-Nov-76	11-Nov-76	Turner, Peter John	PO Box 181, Kalorama, Vic. 3766
1660	18-Jul-89	18-Jul-89	Turnour, Keppel John	590 Orrong Road, Armadale, Vic. 3143
1345	13-Apr-76	13-Apr-76	Tynan, Robert D.	Nightingale Street, Gordon, Vic. 3345
1648	25-Oct-98	25-Oct-98	Tynkkynen, Paavo Jukka Sakari	103 Fraser Crescent, Wantirna South, Vic. 3152
1322	14-Aug-75	14-Aug-75	Tyrrell, Peter John	53 Rose Street, Essendon, Vic. 3040
811	19-Nov-54	19-Nov-54	Urbahns, John George William	PO Box 147, Dromana, Vic. 3336
736	18-Oct-49	18-Oct-49	Valentine, Gordon Victor	2/2 McCubbin Street, Burwood, Vic. 3125
1016	26-Jun-64	26-Jun-64	Van, Allan de Winter	490 Upper Edward Street, Spring Hill, Qld 4004
843	10-Dec-56	10-Dec-56	Van Baer, Brian C.	4 Valanne Street, Brighton East, Vic. 3187
1762	17-Mar-98	17-Mar-98	van den Tol, Wayne John	4 Sam Court, Pine Park Estate Shepparton, Vic. 3630
1165	01-Aug-69	01-Aug-69	Van Riet, John	PO Box 992, Wangaratta, Vic. 3626
1177	26-Aug-70	26-Aug-70	Vardy, Beresford	PO Box 1055, Bendigo, Vic. 3550
1278	08-Aug-74	08-Aug-74	Vassil, Romulus Anthony	7 / 197 Mt Eliza Way, Mount Eliza, Vic. 3930
976	15-Jun-62	15-Jun-62	Veenstra, Cornelius	10 Beacon Point Road, Clifton Springs, Vic. 3222
832	16-Apr-56	16-Apr-56	Veitch, Robert Walter	PO Box 893, Deniliquin, NSW 2710
1571	10-May-84	10-May-84	Verity, Bruce Kingsley	6 Yuruga Court, Mooroolbark, Vic. 3138
1717	27-Apr-94	27-Apr-94	Verrell, Ross Stanley	17 Micheal Court, Berwick, Vic. 3806
1779	18-Apr-00	18-Apr-00	Villella, Glen John	114 Seebeck Road, Rowville, Vic. 3178
1806	17-Apr-02	17-Apr-02	Vincent, Gary Richard	482 Raglan Parade, Warrnambool, Vic. 3280
732	18-Oct-49	18-Oct-49	Vines, John Anthony	1/29 Bringa Avenue, Camberwell, Vic. 3124
1808	17-Apr-02		Vithanage, Mahindapala Daywansa	15 Middlesex Crescent, Shepparton, Vic. 3630
1720	18-May-94	18-May-94	Vroegop, Pieter Bruce	4/85 Hotham Street, Traralgon, Vic. 3844

1214	08-Mar-72	08-Mar-72	Wah, King Tze	20 Floor, China Street, Penang 1020, Malaysia
1288	03-Oct-74	03-Oct-74	Waite, Gary Hugh	15 Bradleys Lane, North Warrandyte, Vic. 3113
1171	23-Feb-70	23-Feb-70	Walkem, Graeme John	3 Bifrons Court, Launceston, Tas. 7250
1297	16-Jan-75	16-Jan-75	Walker, Leslie A.	75 Mann Street, Gosford, NSW 2250
1776	14-Dec-99	14-Dec-99	Walpole, Bruce Donald	PO Box 1124, Albury, NSW 2640
1266	21-Mar-74	21-Mar-74	Walsh, Brian Michael	5A Gertrude Road, Lower Templestowe, Vic. 3107
1374	10-Feb-77	10-Feb-77	Walsh, Bryan Francis	1010 Doncaster Road, Doncaster East, Vic. 3109
1689	27-Nov-91	27-Nov-91	Walsh, James Patrick	PO Box 35, Daylesford, Vic. 3460
1432	04-Oct-78	04-Oct-78	Walsh, John Edward	PO Box 6339 GCMC, Bundall, Qld 4217
1243	27-Feb-73	27-Feb-73	Walter, Leslie Norman	11 Clint Place, Macquarie, ACT 2614
1663	21-Nov-89	21-Nov-89	Walton, Craig A.	1 Mary Street, Jimboomba, Qld 4280
651	22-Mar-41	22-Mar-41	Ward, Keith Jessop	14/11 Williams Street, Frankston, Vic. 3199
1615	20-Nov-86	20-Nov-86	Ward, Michael John	391 Melrose Road, Eugenana, Tas. 7310
790	12-Oct-53	12-Oct-53	Warren, Thomas Ralph	113 Minerva Road, Geelong West, Vic. 3218
1607	21-Oct-86	21-Oct-86	Watson, Brian William	180 Spring Road, Dingley, Vic. 3172
762	15-Feb-52	15-Feb-52	Watson, Peter	290 Kennet Road, Kennet River, Vic. 3221
1680	23-Jan-91	23-Jan-91	Watson, Philip David	PO Box 222, Red Hill South, Vic. 3937
837	25-May-56	25-May-56	Watson, Vernon Roy	7/6 Glenferrie Road, Caulfield North, Vic. 3161
1393	11-Aug-77	11-Aug-77	Webb, Robert Gordon	PO Box 639, Eden, NSW 2551
910	16-Nov-59	16-Nov-59	Webber, Francis J.	112-118 Denham Street, Townsville, Qld 4810
1109	28-Jun-67	28-Jun-67	Webster, Neil Alfred	PO Box 291, Eltham, Vic. 3095
1192	05-Mar-71	05-Mar-71	Weller, Malcolm Eric Laurence	63 Albion Road, Box Hill, Vic. 3128

1355	10-Jun-76	10-Jun-76	Wellington, Russell Thomas	52 Cricklewood Way, Carine, WA 6020
1624	28-Apr-87	28-Apr-87	Wellington, Scott David	PO Box 1091, Ashwood Post Office, Vic. 3147
1001	05-Dec-63	05-Dec-63	Wells, Michael Alfred	PO Box 1, Huskisson, NSW 2540
819	14-Apr-55	14-Apr-55	Wells, Peter John	124 Leicester Street, Parkside, SA 5063
888	04-Feb-59	04-Feb-59	Wellspring, Kevin Henry	P.O.Box 875, Belconnen, ACT 2616
1578	15-Nov-84	15-Nov-84	Wesley, Keith Raymond	17 Tetragona Quadrant, Rowville, Vic. 3178
1150	28-Jan-69	28-Jan-69	Westcott, Geoffrey Patrick	6 Oxford Street, Malvern, Vic. 3144
1468	07-Feb-80	07-Feb-80	Whalan, Peter	PO Box 294, Muswellbrook, NSW 2333
1195	17-May-71	17-May-71	Wheaton, Jeffrey Gordon	RMB 4715, Maffra, Vic. 3860
1368	11-Nov-76	11-Nov-76	Wheeler, Jeffrey Alan	47 Eliza Street, Black Rock, Vic. 3193
1485	24-Jul-80	24-Jul-80	Whelan, Michael Christopher	PO Box 93, Glebe, NSW 2037
1616	19-Feb-87	19-Feb-87	White, Stephen Goss	14 Station Road, Runcorn, Qld 4113
1758	18-Nov-97	18-Nov-97	Whitford, Simon	165 MacAlister Street, Sale, Vic. 3850
1649	25-Oct-88	25-Oct-88	Whyte, Roger John	PO Box 674, Portland, Vic. 3305
1201	20-Aug-71	20-Aug-71	Wilcox, Terance Alan	5 Beauview Parade, Ivanhoe East, Vic. 3079
1756	29-Apr-97	29-Apr-97	Wild, Paul William	538 Riversdale Road, Camberwell, Vic. 3124
1801	18-Sep-01	18-Sep-01	Wilkins, Grant Paul	17/8 The Avenue, Windsor, Vic. 3181
1735	20-Jun-95		Willersdorf, Andrew John	11/765 Burwood Road, East Hawthorn, Vic. 3123
659	21-Mar-42	21-Mar-42	Williams, Alfred O.	PO Box 101, Portland, Vic. 3305
1097	04-Jan-67	04-Jan-67	Williams, John Francis	12 Seaview Crescent, Black Rock, Vic. 3193
1417	13-Apr-78	13-Apr-78	Williams, Peter Kenneth	15/570 Bourke Street, Melbourne, Vic. 3000
1275	25-Jul-74	25-Jul-74	Williamson, Ian Philip	University of Melbourne, Parkville, Vic. 3010
1580	15-Nov-84	15-Nov-84	Wilson, Jeffrey Peter	90 Herries Street, Toowoomba, Qld 4350

1713	15-Dec-93	15-Dec-93	Wilson, Leon Kyle	80 Murray Road, Croydon, Vic. 3136
1749	21-Jun-96	21-Jun-96	Wilson, Michael Craig	17 Bankin Street, Learmonth, Vic. 3352
1335	11-Dec-75	11-Dec-75	Wiltshire, Malcolm John	17 Second Street, Black Rock, Vic. 3193
758	22-Oct-51	22-Oct-51	Windsor, Arnold Lawrence	2 College Street, Williamstown, Vic. 3016
931	08-Jul-60	08-Jul-60	Windust, Allan	38 Ronald Drive, Mandurang, Vic. 3551
1817	19-Jul-02	19-Jul-02	Wolter, Michael David	Level 14, 97 Creek Street, Brisbane, Vic. 4000
913	17-Nov-59	17-Nov-59	Womersley, Leo	8 Dunstan Street, North Balwyn, Vic. 3104
1527	04-Feb-82	04-Feb-82	Wood, Donald Frederick	2 Foy Avenue, Figtree, NSW 2525
1547	17-Feb-83	17-Feb-83	Woodhead, Keith	7 Gowar Avenue, Camberwell, Vic. 3124
937	16-Dec-60	16-Dec-60	Woodward, Lance B.	Address unknown
1498	22-Jan-81	22-Jan-81	Woolford, Tony Neville	72 Grahams Road, Mount Rumney, Tas. 7170
1184	26-Jan-71	26-Jan-71	Worth, Ian Charles	29 Witton Street, Warragul, Vic. 3820
825	23-Nov-55	23-Nov-55	Wyatt, Lewis William Haughton	1/1 Maverston Street, Glen Iris, Vic. 3146
1794	24-Apr-01	24-Apr-01	Wyllie, Scott John	8 Banksia Street, St. Albans, Vic. 3021
676	08-Oct-46	08-Oct-46	Yardy, Keith Dinsmore	16 Mutual Court, Forest Hill, Vic. 3131
1031	07-Jan-65	07-Jan-65	Yeo, Ah Tah	Jurukur Express, 69-1 Jalan Kampung Pandan, Kuala Lumpur, 5510, Malaysia
1052	06-Dec-65	06-Dec-65	Young, Edward Hugh Learmonth	55 Union Street, Armadale, Vic. 3143

Planning and Environment Act 1987
GREATER BENDIGO PLANNING SCHEME
 Notice of Approval of Amendment
 Amendment C42

The Minister for Planning has approved Amendment C42 to the Greater Bendigo Planning Scheme.

The Amendment comes into operation on the date this notice is published in the Government Gazette.

The Amendment rezones land at 339 Guys Hill Road, Strathfieldsaye and land at part 89

Osborne Lane, Strathfieldsaye from Low Density Residential Zone to Residential 1 Zone, and deletes the Development Plan Overlay which applies to the rezoned land.

A copy of the Amendment can be inspected, free of charge, during office hours, at the Department of Sustainability and Environment Customer Service Centre, Upper Plaza, Nauru House, 80 Collins Street Melbourne, the Department of Sustainability and Environment, Northern Regional Planning Office, 57 Lansell Street, Bendigo, and at the Planning Office of the Greater Bendigo City Council, 15 Hopetoun Street, Bendigo.

PAUL JEROME
Executive Director
Planning and Land Division
Department of Sustainability
and Environment

Planning and Environment Act 1987

KINGSTON PLANNING SCHEME

Notice of Approval of Amendment

Amendment C35

The Minister for Planning has approved Amendment C35 to the Kingston Planning Scheme.

The Amendment comes into operation on the date this notice is published in the Government Gazette.

The Amendment rezones land known as 376 Warrigal Road, Heatherton from part Road Zone Category 1 and part Residential 1 Zone to a Mixed Use Zone.

A copy of the Amendment can be inspected, free of charge, during office hours, at the Department of Sustainability and Environment, Planning Information Centre, Upper Plaza, Nauru House, 80 Collins Street, Melbourne and at the offices of the Kingston City Council, Brindisi Street, Mentone.

The Minister has granted the following permit under Division 5 Part 4 of the Act:

Permit No.: KP600/02.

Description of land: 376 Warrigal Road, Heatherton.

PAUL JEROME
Executive Director
Planning and Land Division
Department of Sustainability
and Environment

Planning and Environment Act 1987

MONASH PLANNING SCHEME

Notice of Approval of Amendment

Amendment C19

The Minister for Planning has approved Amendment C19 to the Monash Planning Scheme.

The Amendment comes into operation on the date this notice is published in the Government Gazette.

The Amendment rezones the south-west section of the Waverley Aquatic Centre land, situated at the northern end of Settler Court, Glen Waverley, from a Public Use Zone 6 to a Residential 1 Zone. The Amendment also enables Planning Permit No. 28983 to be issued, allowing a two lot subdivision, eight lot subdivision, and removal of 'reserve' status from Lot 1 on plan PS445100P.

The Minister has granted the following permit under Division 5 Part 4 of the Act:

Permit No.: 28983.

Description of land: South-west section of the Waverley Aquatic Centre land, situated at the northern end of Settler Court, Glen Waverley.

A copy of the Amendment and permit can be inspected, free of charge, during office hours, at the Department of Sustainability and Environment, Planning Information Centre, Upper Plaza, Nauru House, 80 Collins Street, Melbourne and at the offices of the Monash City Council, 293 Springvale Road, Glen Waverley.

PAUL JEROME
Executive Director
Planning and Land Division
Department of Sustainability
and Environment

ORDERS IN COUNCIL

Agricultural and Veterinary Chemicals (Control of Use) Act 1992

**ORDER PROHIBITING OR REGULATING THE SALE OR
USE OF CERTAIN VETERINARY CHEMICAL PRODUCTS**

Order in Council

The Governor in Council makes the following Order:

1. Objective

The objective of this Order is to –

- (a) revoke the Order prohibiting or Regulating the Sale or Use of Certain Veterinary Chemical Products dated 7 July 1998 and published in the Government Gazette G27 on 9 July 1998 (pages 1886 – 1887); and
- (b) regulate the sale or use of certain veterinary chemical products.

2. Authorising provision

This Order is made under sections 25 and 25A of the **Agricultural and Veterinary Chemicals (Control of Use) Act 1992**.

3. Commencement

This Order comes into operation on the day of its publication in the Government Gazette.

4. Revocation

The Order Prohibiting or Regulating the Sale or Use of Certain Agricultural Veterinary Products dated 7 July 1998 and published in Government Gazette G27 on 9 July 1998 (pages 1886 – 1887) is revoked.

5. Definition

In this Order “the Act” means **Agricultural and Veterinary Chemicals (Control of Use) Act 1992**.

6. Sale or use of veterinary chemical products

- (1) A person must not sell or use a veterinary chemical product specified in column 1 of Table 1 if that veterinary product contains a prohibited constituent specified in column 2 of Table 1 opposite that veterinary chemical product

TABLE 1

<i>Column 1</i>	<i>Column 2</i>
Veterinary chemical products	Prohibited constituents
Any veterinary chemical product to be administered to stock	Carbadox Mercury compounds other than thiomersal and phenyl mercuric acetate when used as preservatives Organochlorine chemicals including DDT, dieldrin, lindane endrin, and BHC Reserpine Nitrofurantoin antibacterials Diethylstilboestrol and related compounds Sulfonamide antibacterials except – <ul style="list-style-type: none"> ● sulfadiazine ● sulfadimidine ● sulfadoxine ● sulfaquinoxaline ● sulfatroxazole

<i>Column 1</i>	<i>Column 2</i>
Veterinary chemical products	Prohibited constituents
Any veterinary chemical to be administered to stock or horses	Chloramphenicol
Any veterinary chemical to be administered to be applied topically to stock	Arsenical compounds

- (2) A person must not use a veterinary chemical product specified in column 1 of Table 2 if that veterinary chemical product contains a prohibited constituent that is specified in column 2 of Table 2 opposite that veterinary product unless –
- the use is permitted in a permit issued under sections 6(1), 19 or 25A(2)(b) of the Act; or
 - the use is specified by a permit (and in accordance with any conditions stated in the permit) issued under Part 7 of the Schedule to the **Agricultural and Veterinary Chemicals Code Act 1994** of the Commonwealth; or
 - the use is in accordance with the directions on the label approved by the National Registration Authority for Agricultural and Veterinary Chemicals and that the veterinary chemical product is registered under the Agvet Code of Victoria.

TABLE 2

<i>Column 1</i>	<i>Column 2</i>
Veterinary chemical products	Prohibited constituents
Any veterinary chemical product	Clenbuterol and related beta-agonists Anabolic or androgenic steroids, or hormones including – boldenone, ethyloestrenol, megestrol, methandriol, nandrolone, oestradiol, progesterone, stanozolol, testosterone, trenbolone or zeranol and their derivatives, other than – progesterone and testosterone and their derivatives, when used in conjunction with the artificial insemination of sheep and the use occurs under the written instructions of a registered veterinary practitioner.

Note: Sections 25 and 25A(1) of the act provides for the application of a penalty of, in the case of a corporation, 400 penalty units, and in any other case, 200 penalty units, for breaching those sections.

Dated 6 May 2003

Responsible Minister:
BOB CAMERON
Minister for Agriculture

HELEN DOYE
Clerk of the Executive Council

Local Government Act 1989

CASEY CITY COUNCIL

Specification of Dates

Order in Council

The Governor in Council under Sections 3, 21, 21A and 22 of the **Local Government Act 1989** ORDERS THAT:

the dates for Casey City Council's Strathard Ward by-election to be held on 19 July 2003 shall be:

Monday 12 May 2003 Entitlement date for the purposes of Division 1 of Part 3 of the **Local Government Act 1989**;

Tuesday 20 May 2003 The date by which the Electoral Commissioner must supply to the Chief Executive Officer a voters' list for the purposes of section 21(2) of the **Local Government Act 1989**

Friday 30 May 2003 The date by which the Chief Executive Officer must make out a voters' list for the purposes of sections 22(2) and 22(2A) of the **Local Government Act 1989**

Dated 6 May 2003

Responsible Minister

CANDY BROAD MLC

Minister for Local Government

HELEN DOYE

Clerk of the Executive Council

Transport Accident Act 1986

TRANSPORT ACCIDENT CHARGES ORDER (NO.1) 2003

The Governor in Council, on the recommendation of the Transport Accident Commission, makes the following Order:

Dated 29 April 2003

Responsible Minister

ROB HULLS MP

Minister for WorkCover

HELEN DOYE

Clerk of the Executive Council

1. Title

This Order is called the Transport Accident Charges Order (No.1) 2003.

2. Commencement

This Order comes into operation on 1 July 2003.

3. Definitions

In this order—

“**high risk zone**” means the parts of the State in which addresses are allocated a postcode listed in Part A of Schedule 2 and, except if the Commission otherwise determines under 110(1A) of the Act, any place outside Victoria;

“**low risk zone**” means the parts of the State that are not located in the “high risk zone” or the “medium risk zone”;

“**medium risk zone**” means the parts of the State in which addresses are allocated a postcode listed in Part B of Schedule 2 to this Order;

“**prescribed period**” means the period prescribed for the purposes of section 109 of the Act in relation to a motor vehicle of a certain class specified in regulation 5 of the Transport Accident (Administration of Charges) Regulations 2001;

“**the Act**” means the **Transport Accident Act 1986**.

4. Transport accident charge

- (1) The amount of the transport accident charge applicable to a motor vehicle is the amount shown in Schedule 1 applicable in respect of—
- (a) motor vehicles of that class; and
 - (b) the high risk zone, medium risk zone or low risk zone, as the case may be, in which the motor vehicle is usually kept.

- (2) In the case of a motor vehicle referred to in item 1(c)(i) in Schedule 1, the motor vehicle is deemed to be usually kept in the zone in which it is licensed to operate or, if it is licensed to operate in more than one zone, the zone in respect of which the greater transport accident charge applies.

- (3) If the prescribed period in relation to a motor vehicle is 12 months, the transport accident charge applicable to the motor vehicle in respect of that period is the amount shown in Schedule 1.

- (4) If the prescribed period in relation to a motor vehicle is less than 12 months, the transport accident charge applicable to the motor vehicle in respect of that period is the amount, calculated to the nearest whole dollar, determined in accordance with the formula—

$$\frac{(A \times B)}{365} + \$17$$

where—

A is the amount of the transport accident charge applicable under sub-paragraph (1); and

B is the number of days in the prescribed period.

- (5) Despite sub-paragraph (4), if the prescribed period in relation to a motor vehicle is less than 12 months, and is a whole number of months, the transport accident charge applicable to the motor vehicle in respect of that period is the amount, calculated to the nearest whole dollar, determined in accordance with the formula—

$$\frac{(A \times C)}{12} + \$17$$

where—

A is the amount of the transport accident charge applicable under sub-paragraph (1); and

C is the number of months in the prescribed period.

- (6) If the prescribed period in relation to a motor vehicle is more than 12 months, the transport accident charge applicable to the motor vehicle in respect of that period is the amount, calculated to the nearest whole dollar, determined in accordance with the formula—

$$\frac{(A \times B)}{365}$$

where—

A is the amount of the transport accident charge applicable under sub-paragraph (1); and

B is the number of days in the prescribed period.

- (7) Despite sub-paragraph (6), if the prescribed period in relation to a motor vehicle is more than 12 months and is a whole number of months, the transport accident charge applicable to the motor vehicle in respect of that period is the amount, calculated to the nearest whole dollar, determined in accordance with the formula—
- $$\frac{(A \times C)}{12}$$
- where—
- A is the amount of the transport accident charge applicable under sub-paragraph (1); and
- C is the number of months in the prescribed period.
- (8) If a motor vehicle—
- (a) is owned by an eligible pensioner within the meaning of the **State Concessions Act 1986**; and
 - (b) is eligible to be registered under the **Road Safety Act 1986** without fee in accordance with clause 11, 12, 13 or 14 of Schedule 4 to the Road Safety (Vehicles) Regulations 1999; and
 - (c) is registered or about to be registered under the **Road Safety Act 1986**—
- the transport accident charge applicable to the motor vehicle is one-half of the transport accident charge that would otherwise be payable under sub-paragraph (1).

SCHEDULES
SCHEDULE 1

(Paragraph 4)

TRANSPORT ACCIDENT CHARGES

Item	Class of motor vehicle	Amounts of transport accident charge payable		
		High risk zone \$ (Inc GST)	Medium risk zone \$ (Inc GST)	Low risk zone \$ (Inc GST)
1.	<p>Passenger transport vehicles—</p> <p>(a) Any motor vehicle with private, sedan or station wagon body type; self-propelled caravan; ambulance; hearse; mourning coach; or private hire car licensed under the Transport Act 1983</p> <p>(b) Any motor vehicle with bus or forward control type body, constructed and primarily used for the carriage of passengers but not for hire, fare or reward—</p> <p>(i) seating capacity up to and including 9 people (including the driver)</p> <p>(ii) seating capacity more than 9 people (including the driver)</p> <p>(c) Commercial passenger transport vehicles—</p> <p>(i) Taxi Cab—any motor vehicle which is licensed to stand in a public street for hire</p>	<p>332.00</p> <p>332.00</p> <p>469.00</p> <p>1680.00</p>	<p>296.00</p> <p>295.00</p> <p>295.00</p> <p>1258.00</p>	<p>258.00</p> <p>243.00</p> <p>243.00</p> <p>838.00</p>

		High risk zone \$ (Inc GST)	Medium risk zone \$ (Inc GST)	Low risk zone \$ (Inc GST)
	(ii) Bus—any motor vehicle (other than a taxi cab) licensed for or primarily used for the carriage of passengers for hire, fare or reward—			
	(A) seating up to and including 9 people (including the driver)	1098.00	735.00	254.00
	(B) seating more than 9 but fewer than 31 people (including the driver), the relevant zone charge for a bus under (A), plus for each additional seat over 9	27.00	12.00	3.00
	(C) seating 31 people or more	1680.00	1006.00	333.00
2.	Goods-carrying vehicles —any motor vehicle designed, constructed or primarily used for the conveyance of goods—			
	(a) a vehicle up to and including 2 tonnes carrying capacity (including utility)	333.00	251.00	175.00
	(b) a vehicle over 2 tonnes carrying capacity (excluding prime mover type and motor vehicle classified under Item 2(d))	485.00	423.00	364.00

		High risk zone \$ (Inc GST)	Medium risk zone \$ (Inc GST)	Low risk zone \$ (Inc GST)
	(c) a vehicle registered as a prime mover (other than a vehicle classified under Item 2(d) or a vehicle having a tare mass of 5 tonnes or less	1342.00	1073.00	806.00
	(d) a vehicle over 2 tonnes carrying capacity or prime mover that is used by the owner, if the owner is a primary producer, or by any person on behalf of that owner solely in connection with the primary production operations of the owner	148.00	123.00	99.00
3.	Motor cycles—			
	(a) Motor cycle up to and including 60cc capacity	56.00	56.00	56.00
	(b) Motor cycle from 61cc to 125cc capacity	219.00	193.00	167.00
	(c) Motor cycle from 126cc to 500cc capacity	290.00	260.00	230.00
	(d) Motor cycle of 501cc capacity or more	395.00	353.00	309.00
4.	Miscellaneous vehicles—			
	(a) Road roller, tractor, street flusher, tar sprayer and roller, street sweeper, mobile crane, excavator, forklift, road grader and any vehicle not otherwise classified	250.00	199.00	65.00

		High risk zone \$ (Inc GST)	Medium risk zone \$ (Inc GST)	Low risk zone \$ (Inc GST)
	(b) Any tractor, self-propelled farm machine or motor cycle owned by a primary producer and used solely in connection with the business of the primary producer	56.00	56.00	56.00
	(c) Any vintage, veteran or classic and historic motor vehicle	56.00	56.00	56.00
	(d) Any recreation vehicle.	46.00	46.00	46.00
5.	Special-purpose vehicles—			
	(a) Fire brigade—			
	(i) Any motor vehicle owned by the Metropolitan Fire Brigades Board which is used to combat outbreaks of fire	838.00	838.00	838.00
	(ii) Any motor vehicle owned by the Country Fire Authority or any brigade or group of brigades registered with the Country Fire Authority which is used to combat outbreaks of fire	132.00	132.00	132.00
	(b) Police—			
	(i) Any motor vehicle (excluding a motor cycle) registered in the name of the Victoria Police	1176.00	1176.00	1176.00

	High risk zone \$ (Inc GST)	Medium risk zone \$ (Inc GST)	Low risk zone \$ (Inc GST)
(ii) Any motor cycle registered in the name of the Victoria Police	333.00	333.00	333.00
(c) Motor trades—			
(i) Motor vehicle used by a manufacturer of vehicles, a dealer in vehicles, a fleet owner or a licensed tester of vehicles as defined in the vehicles regulations with general identification mark (trade plate) attached	216.00	163.00	108.00
(ii) Tow truck licensed under the Transport Act 1983	619.00	463.00	311.00
(d) Hire and drive yourself vehicle (Excluding a prime mover classified under item 2(c).	525.00	441.00	378.00

SCHEDULE 2**PART A****Postcodes in the high risk zone**

3000	3026	3050	3073	3106	3136	3163	3184	3206
3001	3027	3051	3074	3107	3137	3164	3185	3207
3002	3028	3052	3075	3108	3138	3165	3186	3428
3003	3031	3053	3076	3109	3141	3166	3187	3800
3004	3032	3054	3078	3110	3142	3167	3188	3802
3005	3033	3055	3079	3111	3143	3168	3189	3803
3006	3034	3056	3081	3121	3144	3169	3190	3975
3008	3036	3057	3082	3122	3145	3170	3191	3976
3010	3037	3058	3083	3123	3146	3171	3192	
3011	3038	3059	3084	3124	3147	3172	3193	
3012	3039	3060	3085	3125	3148	3173	3194	
3013	3040	3061	3086	3126	3149	3174	3195	
3015	3041	3062	3087	3127	3150	3175	3196	
3016	3042	3064	3088	3128	3151	3176	3197	
3018	3043	3065	3093	3129	3152	3177	3198	
3019	3044	3066	3094	3130	3153	3178	3199	
3020	3045	3067	3101	3131	3154	3179	3200	
3021	3046	3068	3102	3132	3155	3180	3201	
3022	3047	3070	3103	3133	3156	3181	3202	
3023	3048	3071	3104	3134	3161	3182	3204	
3025	3049	3072	3105	3135	3162	3183	3205	

PART B**Postcodes in the medium risk zone**

3024	3116	3219	3759	3785	3807	3926	3941
3029	3139	3220	3760	3786	3808	3927	3942
3030	3140	3335	3761	3787	3809	3928	3943
3089	3158	3337	3763	3788	3810	3929	3944
3090	3159	3338	3765	3789	3910	3930	3977
3091	3160	3427	3766	3791	3911	3931	3978
3095	3211	3429	3767	3792	3912	3933	3980
3096	3212	3750	3770	3793	3913	3934	
3097	3214	3751	3775	3795	3915	3936	
3099	3215	3752	3777	3796	3916	3937	
3113	3216	3754	3781	3804	3918	3938	
3114	3217	3755	3782	3805	3919	3939	
3115	3218	3757	3783	3806	3920	3940	

Crown Land (Reserves) Act 1978**NOTICE OF INTENTION TO REVOKE
TEMPORARY RESERVATIONS**

The Governor in Council under section 10 of the **Crown Land (Reserves) Act 1978** gives notice of intention to revoke the following temporary reservations:

BEECHWORTH — The temporary reservation by Order in Council of 1 June, 1971 of an area of 4.694 hectares of land in Section D2, Township of Beechworth, Parish of Beechworth as a site for Public Purposes (Mental Health purposes), revoked as to part by Order in Council of 6 March, 1984 so far as the balance remaining containing 4.406 hectares, more or less. (Rs 09471).

BOROONDARA — The temporary reservation by Order in Council of 29 May, 1945 of an area of 1012 square metres of land in the Parish of Boroondara [formerly At Chatham] as a site for Police purposes. (Rs 5671).

BOROONDARA — The temporary reservation by Order in Council of 18 April, 1950 of an area of 1012 square metres of land in the Parish of Boroondara as a site for Police purposes. (Rs 6527).

ELPHINSTONE — The temporary reservation by Order in Council of 24 December, 1867 of an area of 8.147 hectares of land in the Township and Parish of Elphinstone as a site for the purpose of Victorian Water Supply, revoked as to part by Order in Council of 2 March, 1976 so far only as the portion containing 6352 square metres, more or less, being Crown Allotment 2001, Township of Elphinstone as indicated by hatching on plan hereunder. (GP1125) — (Rs 9332).

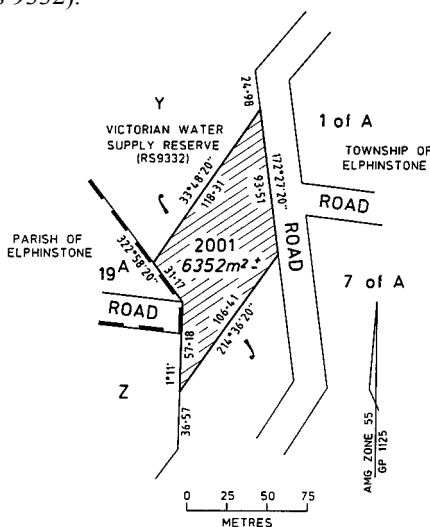

LANDSBOROUGH — The temporary reservation by Order in Council of 21 October, 1872 of an area of 6728 square metres of land in the Township of Landsborough, Parish of Landsborough as a site for Police purposes, revoked as to part by Orders in Council of 1 June, 1993 and 29 September, 1998 so far as the balance remaining containing 1371 square metres. (88/0803).

LANDSBOROUGH — The temporary reservation by Order in Council of 19 January, 1999 of an area of 3656 square metres of land being Crown Allotment 6D, Section O, Township of Landsborough, Parish of Landsborough as a site for Police purposes. (06/15787).

SANDHURST — The temporary reservation by Order in Council of 6 August, 1985 of an area of 3100 square metres, more or less, of land being Crown Allotment 262B, Section O, Parish of Sandhurst as a site for Public Recreation, so far only as the portion containing 330 square metres shown as Crown Allotment 262C, Section O, Parish of Sandhurst on Original Plan No. 120930 lodged in the Central Plan Office. (Rs 12832).

This Order is effective from the date on which it is published in the Government Gazette.

Dated 6 May 2003

Responsible Minister
MARY DELAHUNTY
Minister for Planning

HELEN DOYE
Clerk of the Executive Council

Crown Land (Reserves) Act 1978**REVOCATION OF
TEMPORARY RESERVATIONS**

The Governor in Council under section 10 of the **Crown Land (Reserves) Act 1978** revokes the following temporary reservations:

BONEGILLA — The temporary reservation by Order in Council of 8 October, 1877 of an area of 31.566 hectares, more or less, of land in the Parish of Bonegilla as a site for Public purposes, revoked as to part by various Orders, so far as the balance remaining. (Rs 44).

CLARKESDALE — The temporary reservation by Order in Council of 8 October, 1877 of an area of 1.416 hectares of land in Section B, Parish of Clarkesdale [formerly at Staffordshire Reef] as a site for Cricket and Recreation purposes. (Rs 13525).

ST KILDA — The temporary reservation by Order in Council of 18 May, 1965 of an area of 1189 square metres of land At St Kilda, Parish of Melbourne South, as a site for Public purposes (Police purposes), revoked as to part by Orders in Council of 8 November, 1966 and 20 September, 1983 so far as the balance remaining containing 704 square metres, more or less. (Rs 8441).

This Order is effective from the date on which it is published in the Government Gazette.

Dated 6 May 2003

Responsible Minister
MARY DELAHUNTY
 Minister for Planning

HELEN DOYE
 Clerk of the Executive Council

Crown Land (Reserves) Act 1978
 TEMPORARY RESERVATION OF
 CROWN LANDS

The Governor in Council under section 4(1) of the **Crown Land (Reserves) Act 1978** temporarily reserves the following Crown lands which in his opinion are required for the purposes mentioned:—

MUNICIPAL DISTRICT OF THE MITCHELL SHIRE COUNCIL

KILMORE — Public purposes, 2.6 hectares, more or less, being Crown Allotment 12, Section 30, Township of Kilmore, Parish of Bylands as indicated by hatching on plan hereunder. (GP1162) — (Rs 17070).

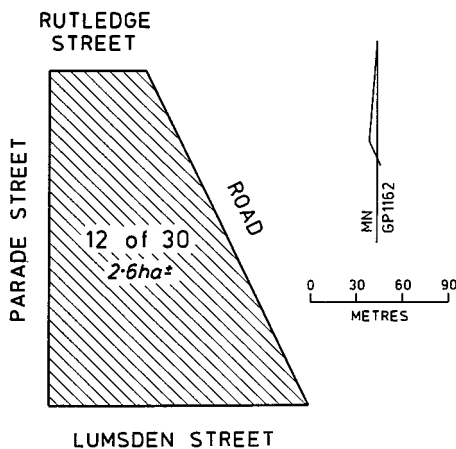

MUNICIPAL DISTRICT OF THE MOIRA SHIRE COUNCIL

MUCKATAH — Conservation of an area of natural interest, combined area 4.046 hectares, being Crown Allotment 1, Section 3, and Crown Allotment 1, Section 4, Township of Muckatah, Parish of Katamatite as indicated by hatching on plan hereunder. (GP1055) — (09/2012760).

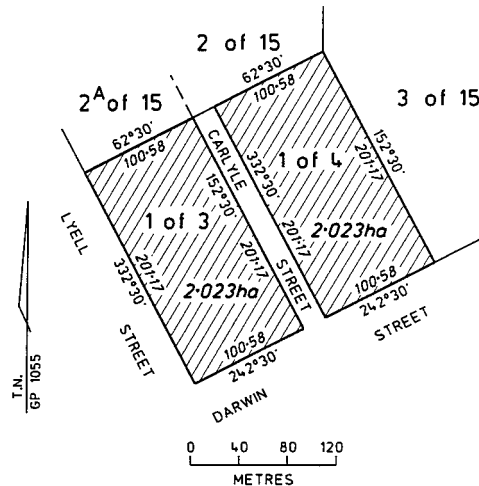

MUNICIPAL DISTRICT OF THE ALPINE SHIRE COUNCIL

MYRTLEFORD — Public purposes (Scout and Guide Hall), 1681 square metres, being Crown Allotment 7C, Section E, Township of Myrtleford, Parish of Myrtleford as indicated by hatching on plan hereunder. (GP1145) — (1104743).

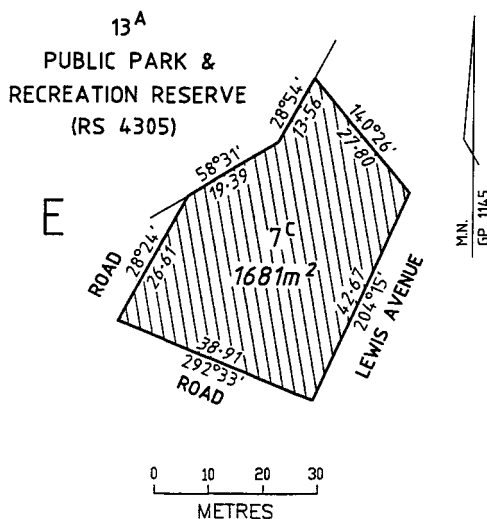

MUNICIPAL DISTRICT OF THE
MELBOURNE CITY COUNCIL

SOUTH MELBOURNE — Public purposes (Public Buildings), 1753 square metres being Crown Allotment 27B, Section B, City of South Melbourne, Parish of Melbourne South as shown on Original Plan No. 121277 lodged in the Central Plan Office. (Rs 37282).

MUNICIPAL DISTRICT OF THE
SWAN HILL RURAL CITY COUNCIL

SWAN HILL — Show Yards and Public Recreation, 479 square metres being Crown Allotment 2001, Township of Swan Hill, Parish of Castle Donnington as indicated by hatching on plan hereunder. (GP1138) — (Rs 2474).

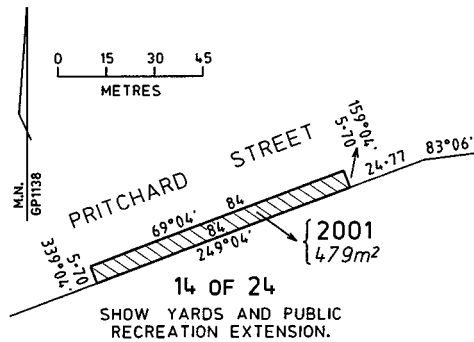

MUNICIPAL DISTRICT OF THE
MURRINDINDI SHIRE COUNCIL

YEA — Public Park, 2440 square metres, more or less, being Crown Allotment 2001, Township of Yea, Parish of Yea as indicated by hatching on plan hereunder. (GP1122) — (Rs 10271).

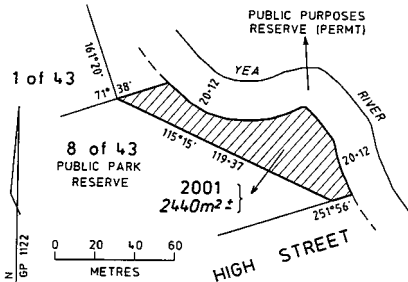

This Order is effective from the date on which it is published in the Government Gazette.

Dated 6 May 2003

Responsible Minister
MARY DELAHUNTY
Minister for Planning

HELEN DOYE
Clerk of the Executive Council

Crown Land (Reserves) Act 1978

Interpretation of Legislation Act 1984

AMENDMENT OF TEMPORARY
RESERVATION – CLARKESDALE

The Governor in Council under section 4 of the **Crown Land (Reserves) Act 1978** and section 27 of the **Interpretation of Legislation Act 1984** amends the Order in Council made on 16 December, 1907 and published in the Government Gazette on 27 December, 1907 page – 5528 of the temporary reservation of an area of 2.084 hectares of land in the Parish of Clarkesdale (formerly At Berringa), County of Grenville as a site for a Night-soil Depot by deletion of the words –Site for a Night-soil Depot” and the substitution therefor of the words “Public Recreation”. Rs 1119.

This Order is effective from the date on which it is published in the Government Gazette Dated 6 May 2003

Responsible Minister
MARY DELAHUNTY
Minister for Planning

HELEN DOYE
Clerk of the Executive Council

Crown Land (Reserves) Act 1978

PERMANENT RESERVATION OF
CROWN LAND

The Governor in Council under section 4(1) of the **Crown Land (Reserves) Act 1978** permanently reserves the following Crown land which in his opinion is required for the purpose mentioned:–

MUNICIPAL DISTRICT OF THE
CITY OF CASEY

CRANBOURNE — Botanic Gardens and Research Institute, 4.867 hectares, being Crown Allotment 2003, Parish of Cranbourne as shown on Original Plan No.121710 lodged in the Central Plan Office. (Rs 9375).

This Order is effective from the date on which it is published in the Government Gazette.

Dated 6 May 2003

Responsible Minister
MARY DELAHUNTY
Minister for Planning

HELEN DOYE
Clerk of the Executive Council

Crown Land (Reserves) Act 1978NOTICE OF INTENTION TO REVOKE
TEMPORARY RESERVATIONS

The Governor in Council under section 10 of the Crown Land (Reserves) Act 1978 gives notice of intention to revoke the following temporary reservations:

AVOCA — The temporary reservation by Order in Council of 17 September, 1963 of an area of 1012 square metres, more or less, of land in Section 32, Township of Avoca, Parish of Avoca as a site for Police purposes. (Rs 536).

BOROONDARA — The temporary reservation by Order in Council of 18 March, 1947 of an area of 1062 square metres of land in the Parish of Boroondara [formerly At Kew] as a site for Police and Court House purposes. (Rs 5936).

GEELONG — The temporary reservation by Order in Council of 7 April, 1999 of an area of 7853 square metres of land being Crown Allotment 10, Section 87, City of Geelong, Parish of Corio as a site for Public purposes (Day Training Centre for Intellectually Disabled Persons), so far only as the portion containing 2320 square metres being Crown Allotment 2004, City of Geelong, Parish of Corio as indicated by hatching on plan hereunder. (GP1157) — (2004421).

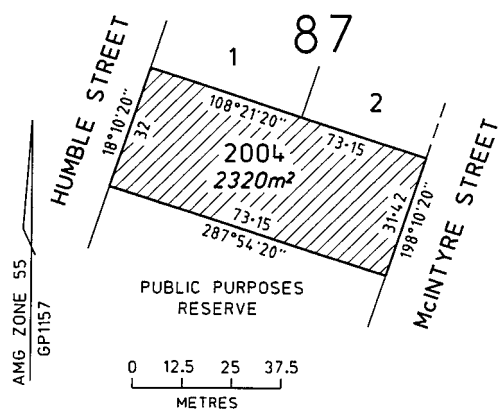

KAMAROOKA — The temporary reservation by Order in Council of 23 July, 1894 of an area of 1.829 hectares of land in the Parish of Kamarooka as a site for Supply of Gravel. (06/16288).

LEARMONTH — The temporary reservation by Order in Council of 16 October, 1934 of an area of 3060 square metres of land in the Township of Learmonth, Parish of Burrumbeet

in two separate portions (formerly Crown Allotments 4 and 4A) as a site for Police purposes, revoked as to part by Order in Council of 1 April, 1976 so far as the balance remaining containing 3007 square metres, more or less. (Rs 4406).

NHILL — The temporary reservation by Order in Council of 8 May, 1984 of a combined area of 430 square metres, more or less, of land being Crown Allotments 10 and 11, Section 16, Township of Nhill, Parish of Balrootan as a site for Public Recreation. (Rs 12307).

WOOLSTHORPE — The temporary reservation by Order in Council of 15 June, 1926 of an area of 4047 square metres of land in Section 18, Township of Woolsthorpe, Parish of Woolsthorpe (formerly Crown Allotment 2) as a site for a Rubbish Depot. (Rs 3328).

YARRAWONGA — The temporary reservation by Order in Council of 13 March, 1935 of an area of 4.548 hectares, more or less, of land in Section 60, Township of Yarrowonga, Parish of Yarrowonga as a site for Municipal Sale-yards, revoked as to part by Order in Council of 25 September, 2001 so far only as the portion containing 4904 square metres shown as Crown Allotment 4, Section 60, Township of Yarrowonga, Parish of Yarrowonga on Original Plan No. 121413 lodged in the Central Plan Office. (Rs 4442).

This Order is effective from the date on which it is published in the Government Gazette.

Dated 6 May 2003

Responsible Minister
MARY DELAHUNTY
Minister for Planning

HELEN DOYE
Clerk of the Executive Council

Crown Land (Reserves) Act 1978REVOCATION OF TEMPORARY
RESERVATIONS

The Governor in Council under section 10 of the **Crown Land (Reserves) Act 1978** revokes the following temporary reservations:

KANIVA — The temporary reservation by Order in Council of 7 August, 1984 of an area of 4889 square metres of land in Section 27, Township of Kaniva, Parish of Kaniva (formerly

being Crown Allotment 17, Section 27) as a site for Hospital purposes. (Rs 12529).

PRAHRAN — The temporary reservation by Order in Council of 15 May, 1956 of an area of 1830 square metres of land in Parish of Prahran as a site for Police purposes. (Rs 7453).

SEATON — The temporary reservation by Order in Council of 13 March, 1893 of an area of 3.116 hectares of land in Section 14, Township of Seaton, Parish of Glenmaggie (formerly Crown Allotments 1, 2, 3, 4, 5, 7, 8, 9, 10, 11 and 12, Section 14) as a site for Public Recreation. (Rs 7514).

This Order is effective from the date on which it is published in the Government Gazette.

Dated 6 May 2003

Responsible Minister
MARY DELAHUNTY
 Minister for Planning

HELEN DOYE
 Clerk of the Executive Council

MUNICIPAL DISTRICT OF THE PYRENEES SHIRE COUNCIL

ENUC — Preservation of an area of ecological significance, combined area 13.98 hectares, more or less, being Crown Allotment 2A, Section 13, and Crown Allotment 2003, Parish of Enucl as indicated by hatching on plans hereunder. (GP1107 & GP1108) — (05/2012492).

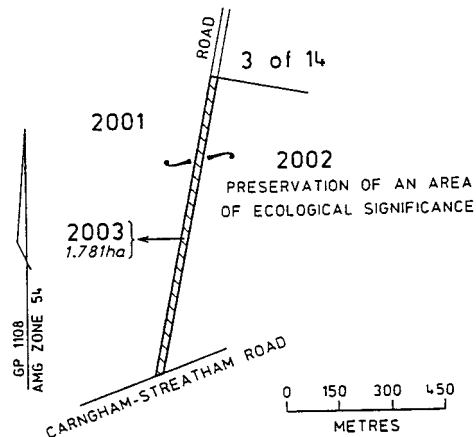
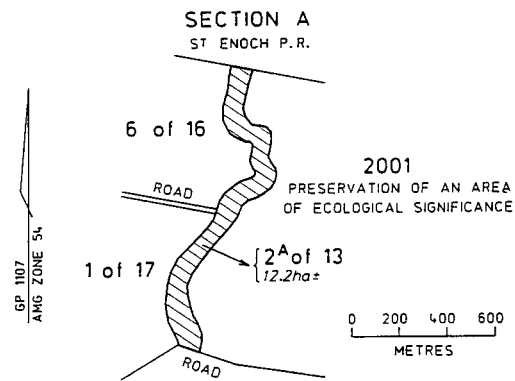

Crown Land (Reserves) Act 1978
 TEMPORARY RESERVATION OF
 CROWN LANDS

The Governor in Council under section 4(1) of the **Crown Land (Reserves) Act 1978** temporarily reserves the following Crown lands which in his opinion are required for the purposes mentioned:-

MUNICIPAL DISTRICT OF THE SHIRE OF BULOKE

DONALD — Public purposes (Police purposes), 1455 square metres, being Crown Allotment 2002, Township of Donald, Parish of Banyenong as indicated by hatching on plan hereunder. (GP1101) — (2012764).

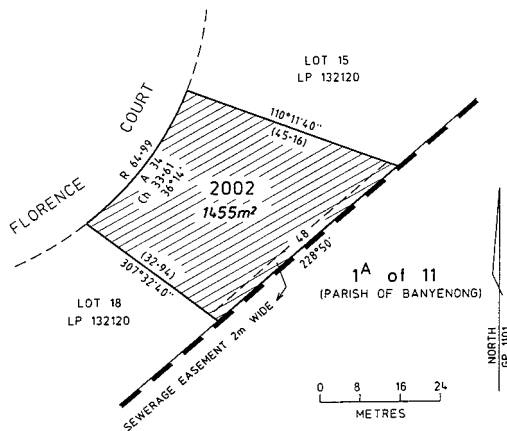

MUNICIPAL DISTRICT OF THE GREATER BENDIGO CITY COUNCIL

HEATHCOTE — Public purposes (Public buildings), 7172 square metres being Crown Allotment 2001, Township of Heathcote, Parish of Heathcote shown as Lot 10 on Plan of Subdivision No. PS 34227A lodged in the Office of Titles. (06/L6-8916).

MUNICIPAL DISTRICT OF THE CARDINIA SHIRE COUNCIL

LANG LANG - Public purposes (Police purposes), 985 square metres, more or less, being Crown Allotment 2001, Parish of Lang Lang as indicated by hatching on plan hereunder. (GP1084) — (Rs 37284).

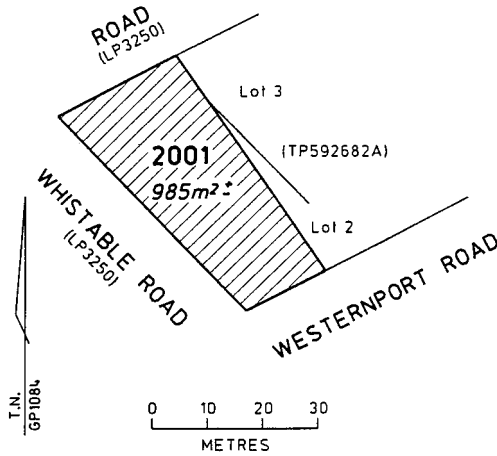

MUNICIPAL DISTRICT OF THE SURF COAST SHIRE COUNCIL

TUTEGONG — Water supply purposes, 200 hectares, more or less, being Crown Allotment 9C, Section 2, Parish of Tutegong as indicated by hatching on plan hereunder. (GP1159) — (Rs 1220).

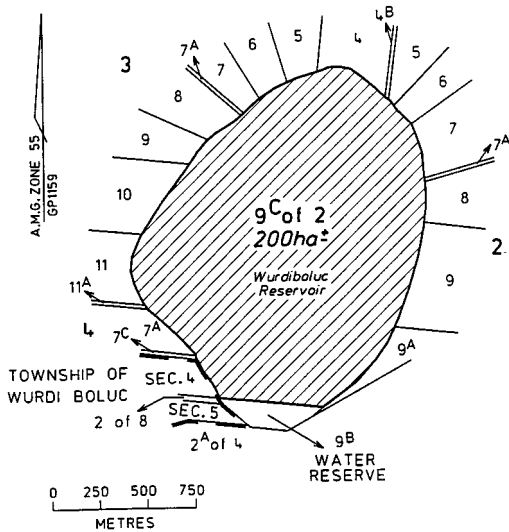

This Order is effective from the date on which it is published in the Government Gazette.

Dated 6 May 2003

Responsible Minister
MARY DELAHUNTY
Minister for Planning

HELEN DOYE
Clerk of the Executive Council

Crown Land (Reserves) Act 1978
Interpretation of Legislation Act 1984
AMENDMENT OF TEMPORARY RESERVATION – WARBURTON

The Governor in Council under Section 4 of the **Crown Land (Reserves) Act 1978** and Section 27 of the **Interpretation of Legislation Act 1984** amends the Order in Council made on 27 February, 1893 and published in the Government Gazette on 3 March, 1893 page – 1151 of the temporary reservation of an area of 4.722 hectares of land in the Township of Warburton, Parish of Warburton, County of Evelyn as a site for a Quarry, revoked as to part by Order in Council of 12 March, 2003 by deletion of the words “Site for a Quarry” and the substitution thereof of the words “Conservation of an area of natural interest”. Rs 31029.

This Order is effective from the date on which it is published in the Government Gazette Dated 6 May 2003

Responsible Minister
MARY DELAHUNTY
Minister for Planning

HELEN DOYE
Clerk of the Executive Council

Land Act 1958

CLOSURE OF UNUSED ROADS

The Governor in Council under section 349 of the Land Act 1958 and with the concurrence in writing of the municipalities in which the roads are situated closes the following unused roads:

MUNICIPAL DISTRICT OF THE GREATER BENDIGO CITY COUNCIL

BENDIGO — The road At Bendigo, Parish of Sandhurst as indicated by hatching on plan hereunder. (GP767) — (DTF/99/1738).

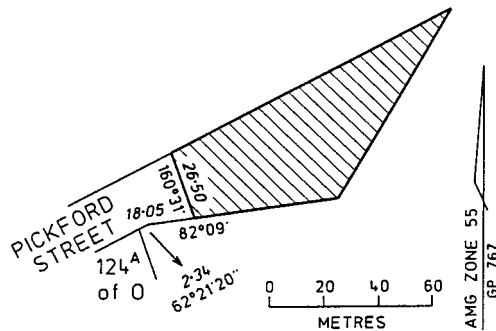

MUNICIPAL DISTRICT OF THE ALPINE SHIRE COUNCIL

POREPUNKAH — The road in the Parish of Porepunkah being Crown Allotment 2026 as indicated by hatching on plan hereunder. (GP1137) — (L8/6659).

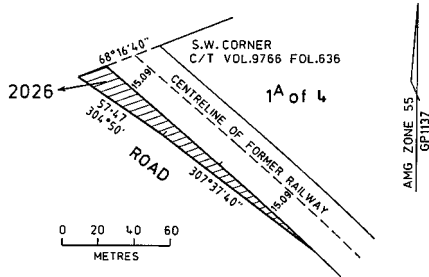

This Order is effective from the date on which it is published in the Government Gazette.

Dated 6 May 2003

Responsible Minister
MARY DELAHUNTY
Minister for Planning

HELEN DOYE
Clerk of the Executive Council

Land Act 1958

CLOSURE OF UNUSED ROADS

The Governor in Council under section 349 of the **Land Act 1958** and with the concurrence in writing of the municipalities in which the roads are situated and the owners of land adjoining those roads closes the following unused roads:

MUNICIPAL DISTRICT OF THE BALLARAT CITY COUNCIL

BALLARAT — The road in the Parish of Ballarat being Crown Allotment 2012 as indicated by hatching on plan hereunder. (GP1150) — (05/01-0008).

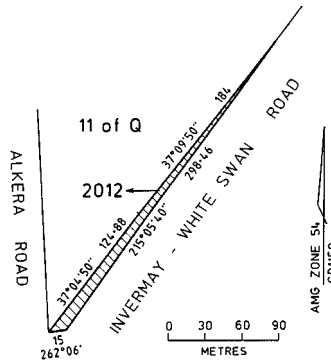

MUNICIPAL DISTRICT OF THE MOYNE SHIRE COUNCIL

COBRA KILLUC — The road in the Parish of Cobra Killuc being Crown Allotment 2003 as indicated by hatching on plan hereunder. (GP950) — (Rs11512).

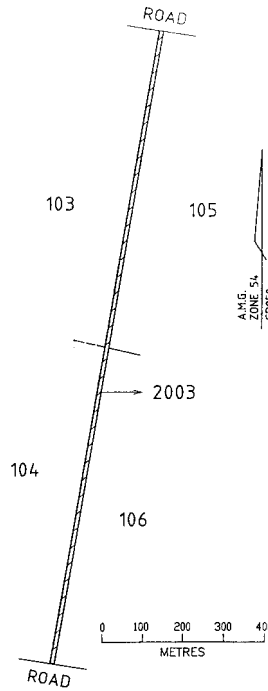

MUNICIPAL DISTRICT OF THE CITY OF CASEY

CRANBOURNE — The road in the Parish of Cranbourne being Crown Allotment 2001 as indicated by hatching on plan hereunder. (GP979) — (Rs 9375).

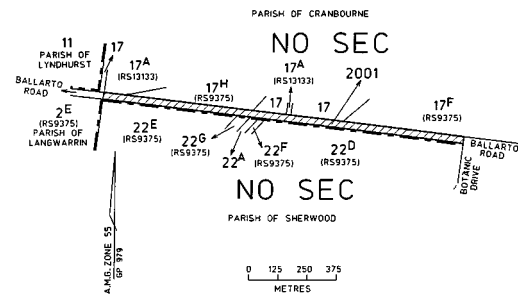

MUNICIPAL DISTRICT OF THE GREATER BENDIGO CITY COUNCIL

EAGLEHAWK — The road At Eaglehawk, Parish of Sandhurst being Crown Allotment 2011 as indicated by hatching on plan hereunder. (GP1059) — (L6-10559).

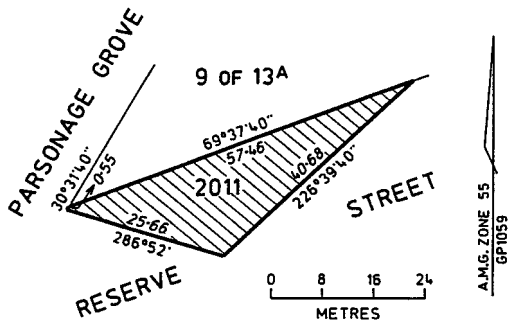

MUNICIPAL DISTRICT OF THE
TOWONG SHIRE COUNCIL

MAGORRA — The roads in the Parish of Magorra being Crown Allotments 2002, 2004 and 2006 as indicated by hatching on plans hereunder. (GP1136, 1139 & 1140) — (P204062).

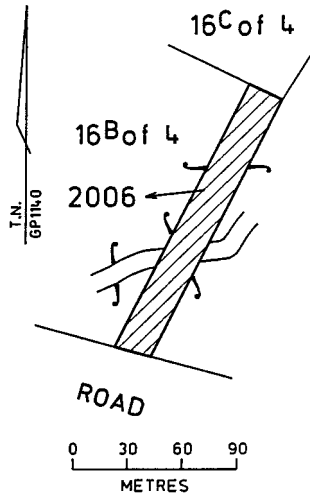
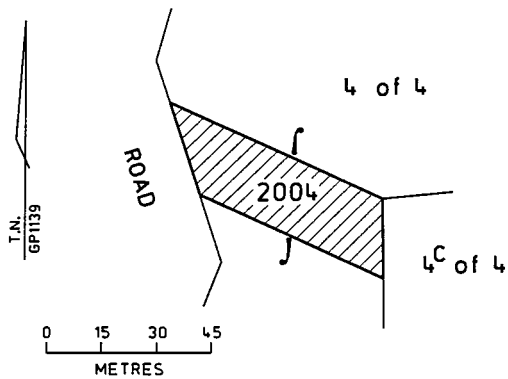
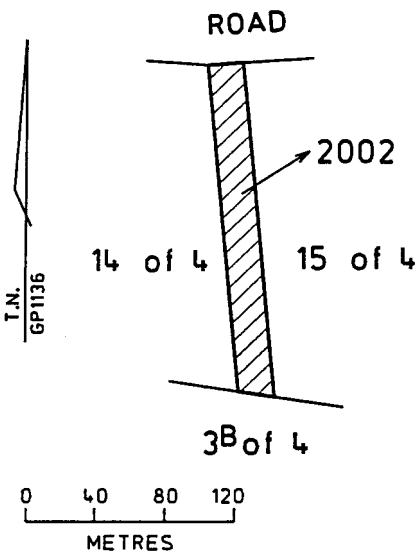

MUNICIPAL DISTRICT OF THE
KNOX CITY COUNCIL

SCORESBY — The road in the Parish of Scoresby being Crown Allotment 2013 as indicated by hatching on plan hereunder. (GP1085) — (12/0278).

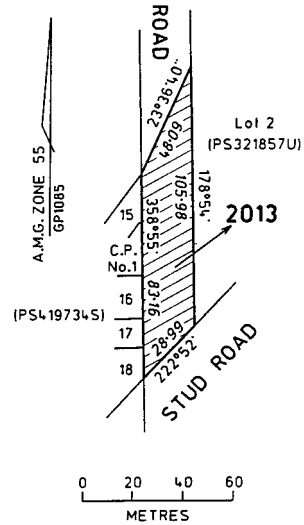

This Order is effective from the date on which it is published in the Government Gazette.

Dated 6 May 2003

Responsible Minister
MARY DELAHUNTY
Minister for Planning

HELEN DOYE
Clerk of the Executive Council

Land Act 1958

AMENDMENT TO TOWNSHIP BOUNDARY – BEECHWORTH

The Governor in Council under Section 25(3)(d) of the **Land Act 1958** amends the Township of Beechworth, proclaimed on 20 October, 1953 and extended by proclamation of 1 September, 1971, by the excision therefrom of the area indicated by diagonal hatching on plan hereunder. (GP66) — (PO-15019).

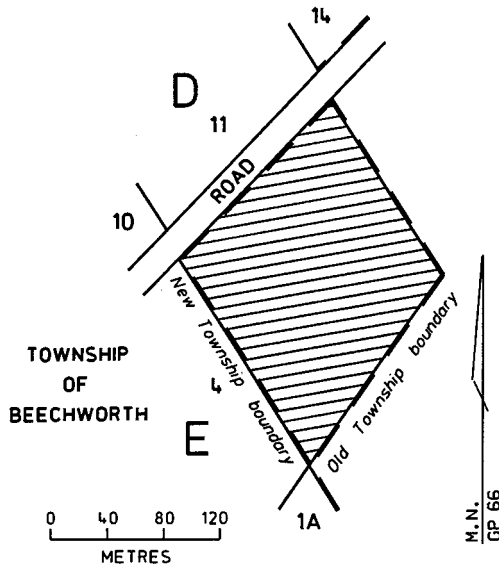

This Order is effective from the date on which it is published in the Government Gazette.

Dated 6 May 2003
 Responsible Minister
MARY DELAHUNTY
 Minister for Planning

HELEN DOYE
 Clerk of the Executive Council

Land Act 1958

CLOSURE OF UNUSED ROAD

The Governor in Council under section 349 of the **Land Act 1958** and with the concurrence in writing of the municipality in which the road is situated closes the following unused road:

MUNICIPAL DISTRICT OF PYRENEES SHIRE COUNCIL

ENUC — The road in the Parish of Enucl being Crown Allotment 2003 as indicated by hatching on plan hereunder. (GP1108) — (05/2012492).

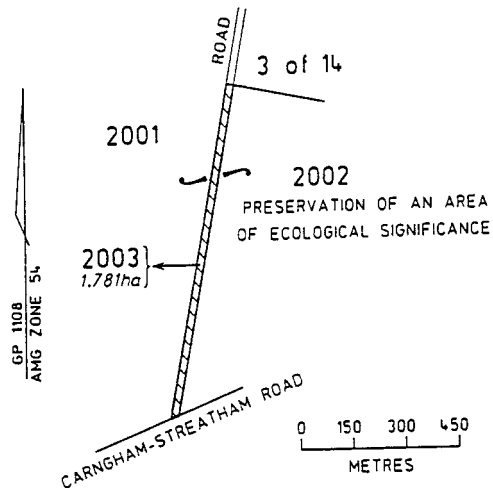

This Order is effective from the date on which it is published in the Government Gazette.

Dated 6 May 2003
 Responsible Minister
MARY DELAHUNTY
 Minister for Planning

HELEN DOYE
 Clerk of the Executive Council

Parliamentary Committees Act 1968

REFERRAL OF INQUIRY TO THE DRUGS AND CRIME PREVENTION COMMITTEE OF PARLIAMENT

Inquiry into Strategies to Reduce Harmful Alcohol Consumption
 Order in Council

The Governor in Council, under section 4F of the **Parliamentary Committees Act 1968**, requests that the:

Drugs and Crime Prevention
 Committee of Parliament

Inquire into, consider and report to Parliament on strategies to reduce harmful alcohol consumption. In particular the Committee is required to:

1. Investigate the nature, extent and culture of alcohol consumption on the Victorian community and the associated costs to the community.
2. Examine the role of alcohol advertising including its influence on harmful alcohol

- consumption and high-risk groups such as young people and Kooris.
3. Review the adequacy of existing strategies for reducing harmful alcohol consumption.
 4. Recommend best practice strategies to address the issue of harmful alcohol consumption, including regulatory, law enforcement, education and treatment responses.
 5. Examine national and international legislation, reports and material relevant to this issue.

The Committee is required to report to Parliament by 30 September, 2004.

Dated 6 May 2003

Responsible Minister:
STEVE BRACKS
Premier

HELEN DOYE
Clerk of the Executive Council

Parliamentary Committees Act 1968
REFERRAL OF INQUIRY TO FAMILY AND
COMMUNITY DEVELOPMENT
COMMITTEE OF PARLIAMENT

Inquiry on the Impact on the Victorian
Community and Public Hospitals on the
Diminishing Access to After Hours and
Bulk Billing General Practitioners

Order in Council

The Governor in Council, under section 4F
of the **Parliamentary Committees Act 1968**,
requests that the:

Family and Community Development
Committee of Parliament

inquire into, consider and report to Parliament
on:

1. The decline in the bulk-billing of general practitioner (GP) services in Victoria since 1996;
2. The increase in patient presentations to public hospital emergency departments in Victoria since 1996, and the extent to which this includes providing types of medical services that normally would be provided by a GP in a primary care setting (GP-type services);

3. The causes of increased presentations to public hospital emergency departments in Victoria since 1996, including difficulties in patients gaining access to bulk-billed and after-hours GP services;
4. The availability of after-hours GP services in metropolitan, regional and rural Victoria;
5. What effective measures can be taken to reduce the number of presentations to public hospital emergency departments consistent with maintaining the principle of universal access of eligible persons to health care free of charge at the point of access; and
6. The extent to which Commonwealth and Victorian legislation may affect Victoria's ability to develop and implement effective and patient-centred solutions to relieve the pressure on public hospital emergency departments to provide GP-type services.

In considering this reference, the Committee should examine:

1. Available bulk-billing, patient out-of-pocket expenses and emergency department data at regional and local levels, highlighting where bulk-billing rates are lowest and where emergency department presentations for urgency categories 4 and 5 are highest;
2. The respective roles and responsibilities of the Commonwealth and the Victorian governments;
3. Relevant Victorian and Commonwealth policies and legislation, including the 1999–2003 and 2003–08 Australian Health Care Agreements; and
4. Innovative and relevant models of care and service delivery in other Australian States and Territories, and overseas.

The Committee is required to report to Parliament by 30 June, 2004.

Dated 6 May 2003

Responsible Minister:
STEVE BRACKS
Premier

HELEN DOYE
Clerk of the Executive Council

Parliamentary Committees Act 1968

REFERRAL OF INQUIRY TO FAMILY AND
COMMUNITY DEVELOPMENT
COMMITTEE OF PARLIAMENT

Inquiry on Improving the Quality of Urban
Design and the Opportunity for Public Art

Order in Council

The Governor in Council, under section 4F
of the **Parliamentary Committees Act 1968**,
requests that the:

Family and Community Development
Committee of Parliament

To inquire into, consider, and make
recommendations on options to improve the
quality of urban design, encourage the better use
of public space, and increase opportunities for
public art in development in Victoria and, in
particular to report on:

1. Mechanisms and good practice for the
delivery of urban art outcomes, both by the
public and private sectors, either as integral
parts of development or as contributions to
art works in the public realm;
2. The adequacy of existing programs and
funding mechanisms for the delivery of, and
support of, urban design and public art, and
make recommendations for cost-effective
improvement in these programs and
mechanisms;
3. Recommendations for mechanisms to
increase funding for urban design and public
art, and in particular ways to forge
partnerships between the public and private
sectors for that purpose;
4. Recommendations to improve community
understanding of, access to, and active
participation in urban design and public art;
5. The need for change to legislation or
statutory requirements to implement any
recommendations made as a result of the
Inquiry.

In conducting the Inquiry, the Committee is
requested to seek information from relevant
organisations in the arts, design and urban
planning sectors, the general community, Local
Government and other Government agencies. In
particular, the Committee is requested to
examine delivery and funding mechanisms for

urban design and public art in other Australian
States and Territories and comparable
mechanisms internationally.

The Committee is required to report to
Parliament by 31 March, 2004.

Dated 6 May 2003

Responsible Minister:
STEVE BRACKS
Premier

HELEN DOYE
Clerk of the Executive Council

Parliamentary Committees Act 1968

REFERRAL OF INQUIRY TO FAMILY AND
COMMUNITY DEVELOPMENT
COMMITTEE OF PARLIAMENT

Inquiry on the Roles of Community Advisory
Committees of Metropolitan Health Services

Order in Council

The Governor in Council, under section 4F
of the **Parliamentary Committees Act 1968**,
requests that the:

Family and Community Development
Committee of Parliament

To inquire into, consider and report to
Parliament on the roles of Community Advisory
Committees of Metropolitan Health Services.
In particular the Committee is required to:

1. Review establishment, composition and
objectives of these Committees in all
Metropolitan Health Services.
2. Report on work programs and achievement
of all Committees.
3. Report on effectiveness of relationships with
Metropolitan Health Services Boards of
Management and senior management of the
Health Services.
4. Make recommendations about the future
directions of the Committees with regard to
the membership, communications and
community interactions with Metropolitan
Health Services.

The Committee is required to report to
Parliament by 31 December, 2003.

Dated 6 May 2003

Responsible Minister:
STEVE BRACKS
Premier

HELEN DOYE
Clerk of the Executive Council

Parliamentary Committees Act 1968

REFERRAL OF INQUIRY TO THE LAW
REFORM COMMITTEE OF PARLIAMENT

Inquiry into the Administration of
Justice Offences
Order in Council

The Governor in Council, under section 4F
of the **Parliamentary Committees Act 1968**,
requests that the:

Law Reform Committee of Parliament

To inquire into, consider and report to
Parliament on:

1. The current state of law in Victoria in
relation to administration of justice offences
(such as perjury, perverting the course of
justice, falsifying evidence and threatening
witnesses); and
2. Whether these laws should be amended, and
in what way, having particular regard to
interstate laws and the recommendations of
the Model Criminal Code Officers Committee
Discussion Paper on Administration of
Justice Offences (July 1997).

The Committee is required to report to
Parliament by 31 December, 2003.

Dated 6 May 2003

Responsible Minister:
STEVE BRACKS
Premier

HELEN DOYE
Clerk of the Executive Council

1. The main causes of fatality and injury on
Victorian farms compared to other
jurisdictions.
2. The matter and type of injuries on Victorian
farms compared to other industries and
jurisdictions.
3. Current programs and initiatives designed to
improve occupational health and safety on
Victorian farms.
4. Any impediments to sustaining
improvements in farm safety.
5. The financial and social cost of death and
injury on Victorian farms.
6. The need for further strategies to reduce the
incidence of injury and fatality on Victorian
farms, what form the strategy should take
and whether they are best developed by
government agencies, industry bodies,
worker representatives or a combination of
these. In particular the committee should
consider the creation of further codes of
practice or education and training programs.

The Committee is required to report to
Parliament by 31 December, 2003.

Dated 6 May 2003

Responsible Minister:
STEVE BRACKS
Premier

HELEN DOYE
Clerk of the Executive Council

Parliamentary Committees Act 1968

REFERRAL OF INQUIRY TO THE RURAL
AND REGIONAL SERVICES AND
DEVELOPMENT COMMITTEE OF
PARLIAMENT

Inquiry into the Cause of Fatality and Injury
on Victorian Farms
Order in Council

The Governor in Council, under section 4F
of the **Parliamentary Committees Act 1968**,
requests that the:

Rural and Regional Services and
Development Committee of Parliament

To inquire into, consider and report to
Parliament on:

This page left blank intentionally

**SUBORDINATE LEGISLATION ACT 1994
NOTICE OF MAKING OF STATUTORY
RULES**

Notice is hereby given under Section 17 (2) of the **Subordinate Legislation Act 1994** of the making of the following Statutory Rules:

33. *Statutory Rule:* Agricultural and Veterinary Chemicals (Infringement Notices) (Amendment) Regulations 2003
Authorising Act: Agricultural and Veterinary Chemicals (Control of Use) Act 1992
Date of making: 6 May 2003
34. *Statutory Rule:* Agricultural and Veterinary Chemicals (Control of Use) (Amendment) Regulations 2003
Authorising Act: Agricultural and Veterinary Chemicals (Control of Use) Act 1992
Date of making: 6 May 2003
35. *Statutory Rule:* Liquor Control Reform (Amendment) Regulations 2003
Authorising Act: Liquor Control Reform Act 1998
Date of making: 6 May 2003
36. *Statutory Rule:* Road Safety (Vehicles) (Registration Fees) Regulations 2003
Authorising Act: Road Safety Act 1986
Date of making: 6 May 2003

**SUBORDINATE LEGISLATION ACT 1994
NOTICE THAT STATUTORY RULES ARE
OBTAINABLE**

Notice is hereby given under Section 17 (3) of the **Subordinate Legislation Act 1994** that the following Statutory Rules were first obtainable from Information Victoria, 356 Collins Street, Melbourne on the date specified:

32. *Statutory Rule:* Tobacco (Amendment) Regulations 2003
Authorising Act: Tobacco Act 1987
Date first obtainable: 6 May 2003
Code A

**PRICING FOR SPECIAL GAZETTE,
PERIODICAL GAZETTE AND VICTORIAN
LEGISLATION**

Retail price varies according to the number of pages in each Victoria Government Special Gazette, Victoria Government Periodical Gazette and Victorian legislation. The table below sets out the prices that apply.

<i>Price Code</i>	<i>No. of Pages (Including cover and blank pages)</i>	<i>Price*</i>
A	1–16	\$3.65
B	17–32	\$5.40
C	33–48	\$7.40
D	49–96	\$11.50
E	97–144	\$14.85
F	145–192	\$17.55
G	193–240	\$20.25
H	241–288	\$21.55
I	289–352	\$24.25
J	353–416	\$28.35
K	417–480	\$32.35
L	481–544	\$37.75
M	545–608	\$43.15
N	609–672	\$48.55
O	673–736	\$53.90
P	737–800	\$59.30

**All Prices Include GST*

ADVERTISERS PLEASE NOTE

As from 8 May 2003

The last Special Gazette was No. 84
dated 7 May 2003

The last Periodical Gazette was No. 1
dated 4 June 2002

CONTENTS

	Page
Estates of Deceased Persons	906
Government and Outer Budget Sector	
Agencies Notices	925
Orders in Council	996
Acts — Agricultural and Veterinary Chemicals (Control of Use); Crown Land (Reserves); Land; Local Government; Parliamentary Committees; Transport Accident	
Private Advertisements	906
Proclamations	923

The Victoria Government Gazette is published by The Craftsman Press Pty. Ltd. with the authority of the Government Printer for the State of Victoria
© State of Victoria 2003

ISSN 0819-5471

This publication is copyright. No parts may be reproduced by any process except in accordance with the provisions of the Copyright Act.

Products and services advertised in this publication are not endorsed by The Craftsman Press Pty. Ltd. or the State of Victoria and neither of them accepts any responsibility for the content or the quality of reproduction. The Craftsman Press Pty. Ltd. reserves the right to reject any advertising material it considers unsuitable for government publication.

Address all enquiries to the
Government Printer for the State of Victoria
Level 2 1 Macarthur Street
Melbourne 3002
Victoria Australia

RETAIL SALES

Information Victoria Bookshop
356 Collins Street Melbourne 3000.
Telephone enquiries 1300 366 356

City Graphics
Level 1, 520 Bourke Street
Melbourne 3000
Telephone enquiries (03) 9600 0977

Recommended Retail Price \$1.85 (includes GST)

Government and Outer Budget Sector Agencies please note:
STYLE REQUIREMENTS.

To ensure that material received can be reproduced, and that errors are minimised, the following guidelines are to be observed when submitting material by fax.

Fax resolution:

Material sent by fax should be transmitted using Fine Resolution (200 dots per inch by 200 dpi).

Font size:

Use 12 point (10 pitch) or larger.

Font Style:

Clear plain font styles, such as Helvetica, should be used.

Graphics:

Line drawings should be transmitted as large as possible to ensure clarity. Drawings up to A4 size sent by fax using Fine Resolution provide a good quality for reproduction.

Avoid:

Italics, underlining and full justification.

Ensure document is square when sending as documents that are sent skewed are difficult to read and process.

ISSN 0819-5471

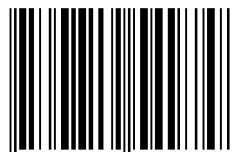

9 770819 549748